

*Allen-Bradley*

## **SLC™ 500 4-Channel Analog I/O Modules**

**(Catalog Numbers 1746-NI4,  
1746-NIO4I, 1746-NIO4V,  
1746-NO4I, and 1746-NO4V)**

**User Manual**

**Rockwell  
Automation**

## Important User Information

Solid state equipment has operational characteristics differing from those of electromechanical equipment. *Safety Guidelines for the Application, Installation and Maintenance of Solid State Controls* (Publication SGI-1.1 available from your local Rockwell Automation sales office or online at <http://www.ab.com/manuals/gi>) describes some important differences between solid state equipment and hard-wired electromechanical devices. Because of this difference, and also because of the wide variety of uses for solid state equipment, all persons responsible for applying this equipment must satisfy themselves that each intended application of this equipment is acceptable.

In no event will Rockwell Automation, Inc. be responsible or liable for indirect or consequential damages resulting from the use or application of this equipment.

The examples and diagrams in this manual are included solely for illustrative purposes. Because of the many variables and requirements associated with any particular installation, Rockwell Automation, Inc. cannot assume responsibility or liability for actual use based on the examples and diagrams.

No patent liability is assumed by Rockwell Automation, Inc. with respect to use of information, circuits, equipment, or software described in this manual.

Reproduction of the contents of this manual, in whole or in part, without written permission of Rockwell Automation, Inc. is prohibited.

Throughout this manual we use notes to make you aware of safety considerations.

---

**WARNING**

Identifies information about practices or circumstances that can cause an explosion in a hazardous environment, which may lead to personal injury or death, property damage, or economic loss.

---

---

**IMPORTANT**

Identifies information that is critical for successful application and understanding of the product.

---

---

**ATTENTION**

Identifies information about practices or circumstances that can lead to personal injury or death, property damage, or economic loss. Attentions help you:

- identify a hazard
  - avoid a hazard
  - recognize the consequence
- 

---

**SHOCK HAZARD**

Labels may be located on or inside the drive to alert people that dangerous voltage may be present.

---

---

**BURN HAZARD**

Labels may be located on or inside the drive to alert people that surfaces may be dangerous temperatures.

---

## Summary of Changes

---

The information below summarizes the changes to this manual since the last printing.

To help you find new and updated information in this release of the manual, we have included change bars as shown to the right of this paragraph.

<b>For information on:</b>	<b>See:</b>
SCP (scale with parameters) instruction available with SLC™ 5/05	6-3, 6-9, 6-15, 6-21
Change in Impedance to ANL Com specification for NI4 Series B module	A-1
Change in Impedance Channel to Channel specification for NI4 Series B module	A-1
Change in Input Impedance specification for NI4 Series B module	A-4
Change in resistance value for NI4 Series B module	Appendix D



	<b>Preface</b>	
	Who Should Use this Manual . . . . .	P-1
	Purpose of this Manual . . . . .	P-1
	Related Documentation . . . . .	P-2
	Common Techniques Used in this Manual . . . . .	P-3
	Your Questions or Comments on this Manual . . . . .	P-3
	<b>Chapter 1</b>	
<b>Overview</b>	How to Use Analog. . . . .	1-1
	Types of Analog Modules . . . . .	1-1
	1746-NI4 Analog Input Module. . . . .	1-2
	1746-NIO4I and NIO4V Analog Combination Modules. . . . .	1-2
	1746-NO4I and NO4V Analog Output Modules . . . . .	1-2
	<b>Chapter 2</b>	
<b>Quick Start for Experienced Users</b>	Required Tools and Equipment . . . . .	2-1
	Procedures . . . . .	2-2
	<b>Chapter 3</b>	
<b>Installing and Wiring Your Analog Module</b>	European Union Directive Compliance . . . . .	3-1
	EMC Directives . . . . .	3-1
	Determining Your Power Requirements for a Modular Controller . . . . .	3-2
	Determining Your Power Requirements for a Fixed Controller . . . . .	3-2
	Configuring Your Module . . . . .	3-5
	Switch Settings for the 1746-NI4. . . . .	3-5
	Switch Settings for the 1746-NIO4I and -NIO4V. . . . .	3-5
	External Power Switch for the 1746-NO4I and -NO4V . . . . .	3-6
	Choosing a Slot in the Chassis . . . . .	3-6
	Installing Your Module . . . . .	3-6
	Removing the Analog Module Terminal Block. . . . .	3-7
	Wiring Considerations . . . . .	3-8
	System Wiring Guidelines. . . . .	3-9
	Grounding Your Cable. . . . .	3-9
	Determining the Cable Length . . . . .	3-10
	Wiring the Analog Module. . . . .	3-10
	Labeling and Installing the Terminal Block. . . . .	3-12
	Grounding the Foil Shields and Drain Wires. . . . .	3-12
	Wiring Schematics for 2, 3, and 4-Wire Analog Input Devices . . . . .	3-14
	Wiring Schematic for Single-ended Analog Input Connections . . . . .	3-15
	Minimizing Electrical Noise on Analog Modules . . . . .	3-15

**Module Operation and System Considerations**

**Chapter 4**

Interface between the Module and the Processor . . . . . 4-1

    Entering Module ID Codes . . . . . 4-1

    Addressing Analog Modules . . . . . 4-2

    Bit Level Addressing . . . . . 4-4

    Processor Update of Analog Data . . . . . 4-5

    Monitoring the Input and Output Data . . . . . 4-5

    Converting Analog Input Data . . . . . 4-6

    Converting Analog Output Data . . . . . 4-7

System Considerations. . . . . 4-9

    Safe State for Outputs . . . . . 4-9

    Retentive Programming Option. . . . . 4-9

    Retentive Analog Output Example . . . . . 4-10

    Non-Retentive Analog Output Example. . . . . 4-11

    During a Mode Change or Power Cycle . . . . . 4-11

    Input Out-of-Range Detection. . . . . 4-11

    Response to Slot Disable . . . . . 4-13

    Input Response to Slot Disable. . . . . 4-13

    Output Response to Slot Disable . . . . . 4-13

    Input Channel Filtering . . . . . 4-14

**Testing Your Module**

**Chapter 5**

Testing the SLC 500 System . . . . . 5-1

    Start-up Procedures . . . . . 5-1

    Inspect the Analog Module. . . . . 5-2

    Disconnect Prime Movers (Motion Devices) . . . . . 5-2

    Power Up the SLC 500 System . . . . . 5-3

    Testing Analog Inputs . . . . . 5-4

    Testing Analog Outputs . . . . . 5-6

**Programming Examples**

**Chapter 6**

Addressing, Out-of-Range Detection, and Scaling of Analog Inputs. . . . . 6-1

    Calculating the Linear Relationship . . . . . 6-2

    Calculating the Out-of-Range Flag Using the Scale Instruction. . . . . 6-3

    Using Standard Math . . . . . 6-4

    Using the Scale (SCL) Instruction . . . . . 6-6

    Using Scale with Parameters (SCP) Instruction. . . . . 6-7

Addressing and Scaling Outputs. . . . . 6-8

    Calculating the Linear Relationship . . . . . 6-8

    Using Standard Math . . . . . 6-10

    Using the Scale with Parameters (SCP) Instruction. . . . . 6-12

Scaling Offset when > 32,767 or < -32,768 . . . . . 6-14

    Calculating the Linear Relationship . . . . . 6-14

	Calculating the Shifted Linear Relationship . . . . .	6-15
	Using Standard Math . . . . .	6-16
	Using the Scale with Parameters (SCP) Instruction . . . . .	6-18
	Scaling and Range Checking and Analog Inputs and Outputs . . . . .	6-20
	Calculating the Linear Relationship . . . . .	6-21
	Using Standard Math Instructions . . . . .	6-22
	Scaling and Range Checking of Analog Inputs and Outputs . . . . .	6-24
	Using SCL Instruction . . . . .	6-25
	Using the Scale with Parameters (SCP) Instruction . . . . .	6-26
	<b>Chapter 7</b>	
<b>Maintenance and Safety</b>	Preventative Maintenance . . . . .	7-1
	Safety Considerations When Troubleshooting . . . . .	7-2
	<b>Appendix A</b>	
<b>Specifications</b>	Analog Modules Specification . . . . .	A-1
	General Specifications for NI4, NIO4I, NIO4V, NO4I, and NO4V . . . . .	A-1
	General Analog Input Specifications for NI4, NIO4I, and NIO4V . . . . .	A-2
	Current-Loop Input Specifications for NI4, NIO4I, and NIO4V . . . . .	A-3
	Voltage Input Specifications for NI4, NIO4I, and NIO4V . . . . .	A-4
	Current Output Specifications for NIO4I and NO4I . . . . .	A-5
	Voltage Output Specifications for NIO4V and NO4V . . . . .	A-6
	<b>Appendix B</b>	
<b>Two's Complement Binary Numbers</b>	Positive Decimal Values . . . . .	A-1
	Negative Decimal Values . . . . .	A-2
	<b>Appendix C</b>	
<b>Optional Analog Input Software Calibration</b>	Calibrating an Analog Input Channel . . . . .	A-1
	Calculating the Software Calibration . . . . .	A-2
	<b>Appendix D</b>	
<b>Module Input and Output Circuits</b>	<b>Index</b>	





Read this preface to familiarize yourself with the rest of the manual. It provides information concerning:

- who should use this manual
- the purpose of this manual
- related documentation
- conventions used in this manual
- Rockwell Automation support

### **Who Should Use this Manual**

Use this manual if you are responsible for designing, installing, programming, or troubleshooting control systems that use SLC 500 4-Channel Analog I/O Modules.

You should have a basic understanding of electrical circuitry and familiarity with relay logic. If you do not, obtain the proper training before using this product.

### **Purpose of this Manual**

This manual describes the procedures you use to install, wire, and troubleshoot your 4-channel analog I/O module. This manual:

- explains how to install and wire your module
- gives you an overview of the SLC 500 programmable controller system

Refer to your programming software user documentation for more information on programming your SLC 500 programmable controller.

## Related Documentation

The following documents contain additional information concerning Rockwell Automation products. To obtain a copy, contact your local Rockwell Automation office or distributor.

<b>For</b>	<b>Read this Document</b>	<b>Document Number</b>
In-depth information on the SLC Instruction Set.	<i>SLC 500 Instruction Set Reference Manual</i>	1747-RM001
A description on how to install and use your Modular SLC 500 programmable controller.	<i>SLC 500 Modular Hardware Style User Manual</i>	1747-UM011
A description on how to install and use your Fixed SLC 500 programmable controller.	<i>SLC 500 Fixed Hardware Style Installation &amp; Operation Manual</i>	1747-6.21
A description on how to install 4-channel analog I/O modules	<i>SLC 500 4-Channel Analog I/O Modules Installation Instructions</i>	1746-IN008
Information on reducing electrical noise.	<i>System Design for Control of Electrical Noise</i>	GMC-RM001
In-depth information on grounding and wiring Allen-Bradley® programmable controllers.	<i>Allen-Bradley Programmable Controller Grounding and Wiring Guidelines</i>	1770-4.1
A description of important differences between solid-state programmable controller products and hard-wired electromechanical devices.	<i>Application Considerations for Solid-State Controls</i>	SIG-1.1
An article on wire sizes and types for grounding electrical equipment.	<i>National Electrical Code - Published by the National Fire Protection Association of Boston, MA.</i>	
A glossary of industrial automation terms and abbreviations.	<i>Allen-Bradley Industrial Automation Glossary</i>	AG-7.1

If you would like a manual, you can:

- download an electronic version from the internet at:
  - [www.theautomationbookstore.com](http://www.theautomationbookstore.com)
  - <http://ab.com/manuals>
- order a printed manual by:
  - contacting your local distributor or Rockwell Automation representative
  - visiting [www.theautomationbookstore.com](http://www.theautomationbookstore.com)
  - calling 1.800.963.9548 (USA/Canada) or 001.330.725.1574 (Outside USA/Canada)

## **Common Techniques Used in this Manual**

The following conventions are used throughout this manual:

- Bulleted lists such as this one provide information, not procedural steps.
- Numbered lists provide sequential steps or hierarchical information.
- *Italic* type is used for emphasis.

## **Your Questions or Comments on this Manual**

If you find a problem with this manual, or you have any suggestions for how this manual could be made more useful to you, please contact us at the address below:

Rockwell Automation  
Automation Control and Information Group  
Technical Communication, Dept. A602V  
P.O. Box 2086  
Milwaukee, WI 53201-2086



## Overview

This chapter describes how analog is used and provides two application examples of analog. The types of available analog modules and their related specifications are also described.

### How to Use Analog

Analog refers to the representation of numerical quantities by the measurement of continuous physical variables. Analog applications are present in many forms. The following application shows a typical use of analog.

In this application the processor controls the amount of fluid placed in a holding tank by adjusting the percentage of the valve opening. The valve is initially open 100%. As the fluid level in the tank approaches the preset point, the processor modifies the output to degrade closing the valve 90%, 80%, adjusting the valve to maintain a set point.

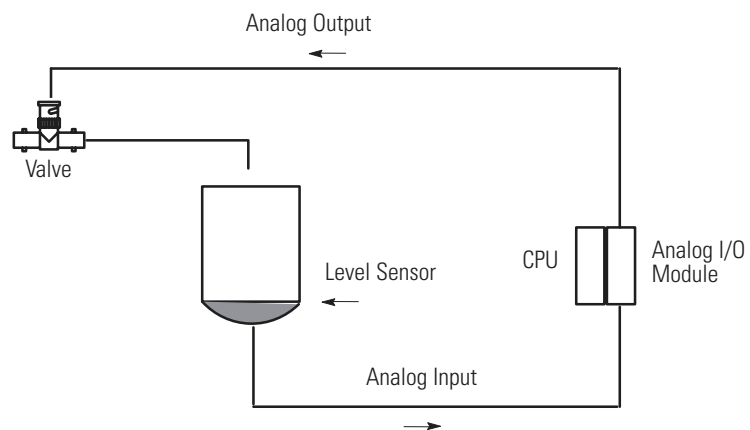

### Types of Analog Modules

The following sections provide an overview of the various analog modules.

## 1746-NI4 Analog Input Module

The 1746-NI4 Analog Input module contains 4 analog input channels that are user selectable per channel for voltage or current to support a variety of monitoring and controlling applications

## 1746-NIO4I and NIO4V Analog Combination Modules

The NIO4I and NIO4V Analog Combination I/O modules provide two input and two output channels in a single slot module. The 1746-NIO4I module contains two current or voltage inputs (user selectable per channel), and two current outputs. The 176-NIO4V module contains two current or voltage inputs (user selectable per channel) and two voltage outputs.

## 1746-NO4I and NO4V Analog Output Modules

The NO4I and NO4V Analog Output Modules provide 4 analog output channels. The NO4I module contains four current outputs. The NO4V module contains four voltage outputs. Both of these modules support a variety of monitoring and controlling applications.

Catalog 1746-	Input Channels per Module	Output Channels per Module	Backplane Current Draw		External 24V dc Power Supply Tolerances
			5V (max.)	24V (max.)	
NI4	4 differential, voltage or current selectable per channel, not individually isolated	NA	35 mA	85 mA	NA
NIO4I	2 differential, voltage or current selectable per channel, not individually isolated	2 current outputs, not individually isolated	55 mA	145 mA	NA
NIO4V	2 differential, voltage or current selectable per channel, not individually isolated	2 voltage outputs, not individually isolated	55 mA	115 mA	NA
NO4I	NA	4 current outputs, not individually isolated	55 mA	195 mA	24 ±10% at 195 mA max. (21.6 to 26.4V dc) <sup>(1)</sup>
NO4V	NA	4 voltage outputs, not individually isolated	55 mA	145 mA	24 ±10% at 145 mA max. (21.6 to 26.4V dc) <sup>(1)</sup>

(1) Required for some applications if SLC 24V power is not readily available.

For more specification information, refer to Appendix A.

## Quick Start for Experienced Users

This chapter can help you to get started using analog. The procedures are based on the assumption that you have an understanding of SLC 500 products. You should understand electronic process control and be able to interpret the ladder logic instructions required to generate the electronic signals that control your application.

Because it is a start-up guide for experienced users, this chapter *does not* contain detailed explanations about the procedures listed. It does, however, reference other chapters in this book where you can get more information.

If you have any questions or are unfamiliar with the terms used or concepts presented in the procedural steps, *always read the referenced chapters* and other recommended documentation before trying to apply the information.

This chapter:

- tells you what tools and equipment you need
- lists preliminary considerations
- describes when to configure the module
- explains how to install and wire the module
- discusses system power-up procedures

### Required Tools and Equipment

Have the following tools and equipment ready:

- small blade screwdriver
- an adequate length of communication cable (Belden™ 8761) for your specific application. (See chapter 3, *Installing and Wiring Your Analog Module* for maximum cable distances.)
- programming equipment

## Procedures

### 1. Check the contents of shipping box.

#### Reference

Unpack the shipping box making sure that the contents include:

- Analog I/O module (Catalog Number 1746-Series)
- installation instructions (publication 1746-IN008)

If the contents are incomplete, call your local Allen–Bradley representative for assistance.

### 2. Determine your power requirements for the modular controller.

#### Reference

Review the power requirements of your system to see that your chassis supports placement of the analog module.

- For modular style systems, calculate the total load on the system power supply using the procedure described in the *SLC 500 Modular Hardware Style User Manual* (publication 1747-UM011) or the *SLC 500 Family System Overview* (publication 1747-SO001).
- For fixed SLC 500 controllers, refer to the *SLC 500 Fixed Hardware Style Installation & Operation Manual* (publication 1747-6.21).

**Chapter 3**  
*(Installing and Wiring Your Analog Module)*

**Appendix A**  
*(Specifications)*

Catalog Number	Backplane Current Draw		External 24V dc Power Supply Tolerance
	5V (max.)	24V (max.)	
1746-NI4	35 mA	85 mA	NA
1746-NIO4I	55 mA	145 mA	NA
1746-NIO4V	55 mA	115 mA	NA
1746-NO4I	55 mA	195 mA	24 ±10% at 195 mA max. (21.6 to 26.4V dc) <sup>(1)</sup>
1746-NO4V	55 mA	145 mA	24 ±10% at 145 mA max. (21.6 to 26.4V dc) <sup>(1)</sup>

<sup>(1)</sup> Required for some applications if SLC 24V power is not readily available.



<b>3.</b>	<b>Configure the module using the DIP switches (analog inputs only).</b>	<b>Reference</b>
-----------	--	------------------

Each analog input channel can be configured for either voltage or current. Locate the DIP switches on your module and set them for your application.

**Chapter 3**  
*(Installing and Wiring Your Analog Module)*

- ON – Configures channel for current input
- Off – Configures channel for voltage input

**1746-NI4**

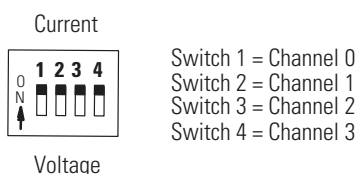

**1746-NIO4I,NIO4V**

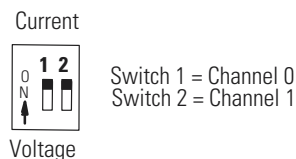

**1746-NO4I, NO4V**

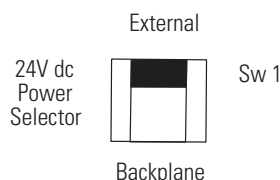

<b>4.</b>	<b>Install your module.</b>	<b>Reference</b>
-----------	-----------------------------	------------------

When selecting a slot for an analog module, position the module:

- in a slot away from ac or high voltage dc modules
- in the chassis closest to the bottom of the enclosure where the SLC 500 system is installed
- away from the chassis power supply if installed in a modular system

**Chapter 3**  
*(Installing and Wiring Your Analog Module)*

**ATTENTION**



Never install, remove, or wire modules with power applied to the chassis or devices wired to the modules.

Make sure system power is off; then insert the analog module into your 1746 chassis. In this example procedure, local slot 1 is selected.

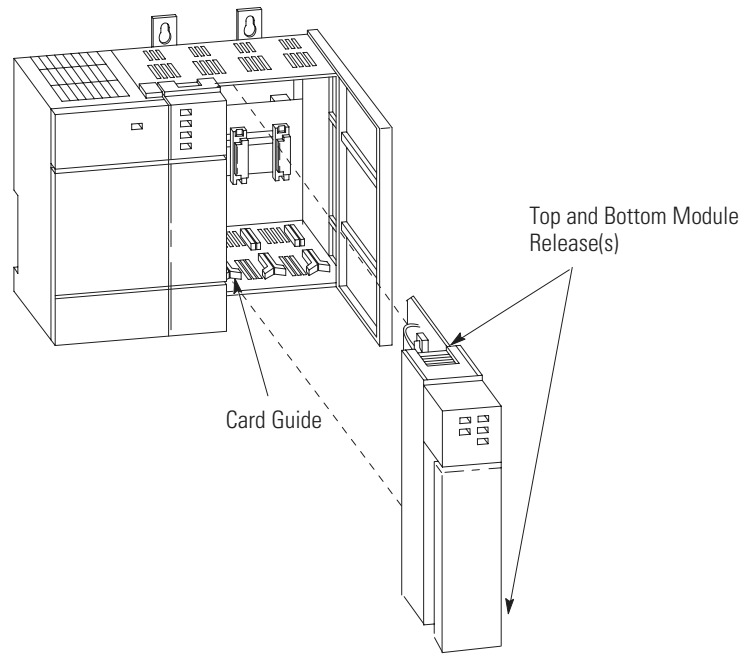
**5. Wire the module.****Reference**

**Important:** Follow these guidelines when wiring the module.

- Use shielded communication cable (Belden 8761) and keep length as short as possible.
- Connect only one end of the cable shield to earth ground.
- Channels are not isolated from each other. All analog commons are connected together internally.
- The module does not provide power for analog inputs.
- Use a power supply that matches the transmitter (sensor) specifications.

**Chapter 3**  
*(Installing and  
Wiring Your  
Analog Module)*

**NI4**

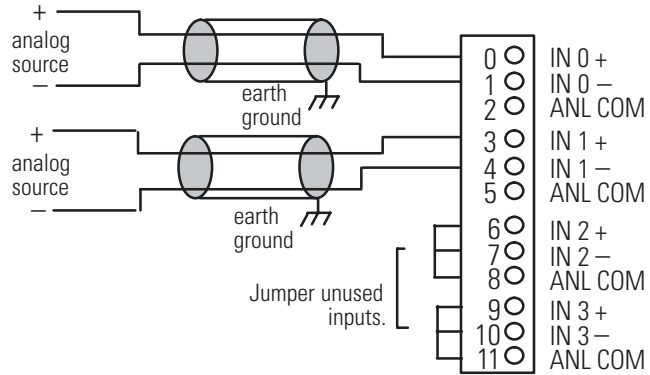

**NI04I & NI04V**

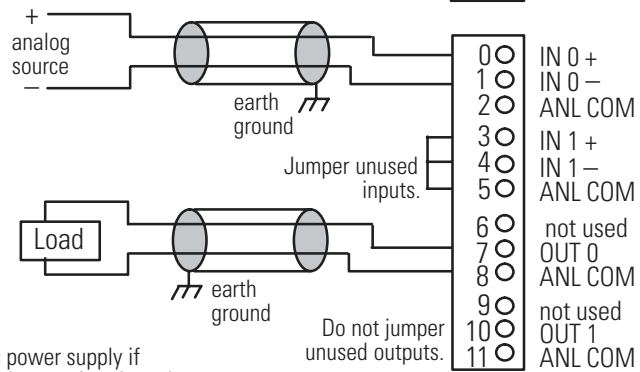

**NO4I & NO4V**

24V dc power supply if external power is selected. Cable length from external 24V dc power supply to analog module must be less than 10m.

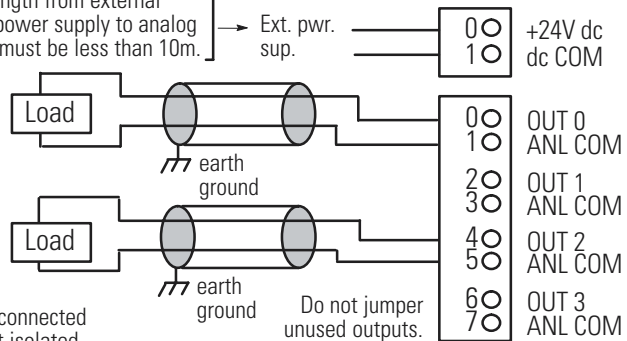

Analog commons are internally connected in the module. Channels are not isolated from each other.

<b>6.</b>	<b>Configure system I/O configuration.</b>	<b>Reference</b>
-----------	--	------------------

Configure your system I/O configuration for the particular slot the analog module is in. When assigning an I/O module to a slot location, select the module from the displayed list. If not listed, select *OTHER* at the bottom of the list and enter the module's ID code at the prompt.

**Chapter 4**  
*(Module Operation and System Considerations)*

Catalog No.	Module ID Code
1746-NI4	4401
1746-NIO4I	3201
1746-NIO4V	3202
1746-NO4I	5401
1746-NO4V	5402

<b>7.</b>	<b>Check that the module is operating correctly.</b>	<b>Reference</b>
-----------	--	------------------

**Chapter 5**  
*(Testing Your Module)*

**ATTENTION**



Machine motion during system checkout can be hazardous to personnel. During all checkout procedures, you must disconnect all devices which, when energized, might cause machine motion.

Apply power to the fixed or modular system. The analog module LED (red) should be illuminated, indicating that the module is receiving 24V dc power.

**8. Understanding analog inputs.****Reference**

Analog inputs convert current and voltage signals into 16-bit (max.) integer values and place them in the input image for the slot that the analog module resides in.

**Chapter 4**  
*(Module  
Operation and  
System  
Considerations)*

Address	1746-NI4	1746-NI04I, -NI04V
I:e.0	Input Channel 0	Input Channel 0
I:e.1	Input Channel 1	Input Channel 1
I:e.2	Input Channel 2	
I:e.3	Input Channel 3	

Note: The e is the slot number.

Voltage/Current Range	Integer Representation
-10V dc to +10V dc	-32,768 to +32,767
0 to 10V dc	0 to 32,767±10V dc
0 to 5V dc	0 to 16,384
1 to 5V dc	3,277 to 16,384
-20 mA to +20 mA	-16,384 to +16,384
0 to 20 mA	0 to 16,384±20 mA
4 to 20 mA	3,277 to 16,384

<b>9.</b>	<b>Understanding analog outputs.</b>	<b>Reference</b>
-----------	--------------------------------------	------------------

Analog outputs convert 16-bit integer values placed in the output image to voltage or current signals for the slot that the analog card is in.

**Chapter 4**  
*(Module Operation and System Considerations)*

Address	1746-NO4	1746-NIO4I, -NIO4V
O:e.0	Output Channel 0	Output Channel 0
O:e.1	Output Channel 1	Output Channel 1
O:e.2	Output Channel 2	
O:e.3	Output Channel 3	

1746-NO4I, -NIO4I		1746-NO4V, -NIO4V	
Current Range	Decimal Representation for Output Word	Voltage Range	Decimal Representation for Output Word
0 to 21 mA	0 to 32,764	-10 to +10V dc	-32,768 to +32,764
0 to 20 mA	0 to 31,208	0 to 10V dc	0 to 32,764
4 to 20 mA	6,242 to 31,208	0 to 5V dc	0 to 16,384
		1 to 5V dc	3,277 to 16,384

<b>10.</b>	<b>Write ladder logic to process the module's analog data.</b>	<b>Reference</b>
------------	--	------------------

Several programming examples are provided in chapter 6 that demonstrate how to scale the raw data from the analog card into engineering units such as psi, percent, etc. Study these examples and apply them to your application as appropriate.

**Chapter 5**  
*(Testing Your Module)*

**Chapter 6**  
*(Programming Examples)*

## Installing and Wiring Your Analog Module

To obtain the maximum performance from an analog module, proper module installation is imperative. This chapter describes the procedures that you must follow to install the analog module in an SLC 500 system. The following items are described:

- European Union Directive Compliance
- determining your power requirements
- configuring your module
- selecting a slot in the chassis
- installing your module
- wiring considerations
  - system wiring guidelines
  - grounding your cable
  - determining the cable length
- wiring the analog module
- minimizing electrical noise on the analog module

### European Union Directive Compliance

If this product is installed within the European Union or EEA regions and has the CE mark, the following regulations apply.

#### EMC Directives

This product is tested to meet Council Directive 89/336/EEC Electromagnetic Compatibility (EMC) and the following standards, in whole or in part, documented in a technical construction file:

- EN 50081–2  
EMC - Generic Emission Standard, Part 2 - Industrial Environment
- EN 50082–2  
EMC - Generic Immunity Standard, Part 2 - Industrial Environment

This product is intended for use in an industrial environment.

## Determining Your Power Requirements for a Modular Controller

Analog modules require both 5V dc and 24V dc power from the backplane of the SLC 500 system. However, the NO4I and NO4V analog modules can use an external 24V dc power supply. This eliminates the 24V dc backplane power requirement, providing configuration flexibility if SLC power supply loading is critical. These two modules provide user-supplied external 24V dc power supply connections.

The 24V dc user power connection on a fixed SLC 500 can power an NO4I or NO4V analog module. However, the regulation of the 24V dc user connection on a modular SLC 500 power supply, Catalog Number 1746-P1, -P2, -P4 is outside of the requirements of the NO4I and NO4V analog modules and cannot be used.

The following table shows the power requirements for each analog module using backplane power. Use this table to calculate the total load on the modular system power supply. For more information refer to the SLC 500 user manual for modular controllers.

**IMPORTANT**

The analog modules do not supply loop power for the input device. You must supply the appropriate loop power for loop-powered input devices.

Catalog Number	5 Volt Current	24 Volt Current
1746-NI4	35 mA	85 mA
1746-NIO4I	55 mA	145 mA
1746-NIO4V	55 mA	115 mA
1746-NO4I	55 mA	195 mA <sup>(1)</sup>
1746-NO4V	55 mA	145 mA <sup>(1)</sup>

<sup>(1)</sup> Omit these values from your SLC power supply loading calculations if you decide to use an external power supply.

## Determining Your Power Requirements for a Fixed Controller

The chart starting on the next page provides available analog module combinations in the expansion chassis of a fixed controller.

- valid combination
- invalid combination
- valid combination when used with external power supply

BASIC net = Basic Module is supplying power to an AIC. No other device requiring power is connected to the AIC.



<b>NI4</b>	<b>NIO4I</b>	<b>NIO4V</b>	<b>NO4I</b>	<b>NO4V</b>	
•	•	•	–	•	IA4
•	•	•	▽	•	IA8
•	•	•	▽	•	IA16
•	•	•	▽	•	IM4
•	•	•	▽	•	IM8
•	•	•	▽	•	IM16
•	•	•	▽	•	OA8
			▽	▽	OA16
			▽	▽	OAP12
•	•	•	▽	•	IB8
•	•	•	▽	•	IB16
•	•	•	▽	•	IV8
•	•	•	▽	•	IV16
•	•	•	▽	•	IG16
•	•	•	▽	•	OV8
•		•	▽	▽	OV16
•	•	•	▽	•	OB8
•	•	•	▽	•	OG16
•		•	▽	▽	OW4
•			▽	▽	OW8
			▽	▽	OW16
•	•	•	▽	•	IO4
•		•	▽	▽	IO8
•			▽	▽	IO12
•			▽	▽	NI4
			▽	▽	NIO4I
			▽	▽	NIO4V
			▽	▽	DCM
•			▽	▽	HS
•			▽	▽	OB16
•	•	•	▽	•	IN16
			▽	▽	BASIC net
•		•	▽	▽	BASIC
					OB32
					OV32

NI4	NI04I	NI04V	NO4I	NO4V	
•	•	•	∇	•	IV32
•	•	•	∇	•	IB32
•			∇	∇	OX8
∇	∇	∇	∇	∇	NO4I
∇	∇	∇	∇	∇	NO4V
•	•	•	∇	•	ITB16
•	•	•	∇	•	ITV16
•	•	•	∇	•	IC16
•		•	∇	∇	OBP16
•		•	∇	∇	OVP16
•	•	•	∇	•	NT4
•	•	•	∇	•	NR4

---

**IMPORTANT** The NO4I and NO4V modules provide user supplied external 24V dc power supply connections. When the NO4I module is used in a fixed controller, you must provide an external power supply.



---

When the NO4I or NO4V is used with an external 24V dc power supply and is placed in a fixed controller expansion chassis, it is compatible with those modules noted in the compatibility chart starting on the previous page. When set for external power, the module will only draw the 5V current off the backplane. Refer to the next section for details on how to configure your module for external power.

The 24V dc user power connection on a fixed SLC 500 can power an NO4I or NO4V analog module. However, the regulation of the 24V dc user connection on a modular SLC 500 power supply, Catalog Number 1746-P1, -P2, and -P4 is outside of the requirements of the NO4I and NO4V analog modules and cannot be used.

## Configuring Your Module

The NI4, NIO4I and NIO4V analog modules have user selectable DIP switch settings which allow you to configure the input channels as either current or voltage inputs. The switches are located on the analog module board. The following illustration shows the ON and OFF switch settings. Switch orientation is also provided on the nameplate of the module.

-  ON – Configures channel for current input
-  OFF – Configures channel for voltage input

### ATTENTION



Care should be taken to avoid connecting a voltage source to a channel configured for current input. Improper module operation or damage to the module can occur.

## Switch Settings for the 1746–NI4

The NI4 has 4 individual DIP switches that control the input mode of input channels 0 through 3. A switch in the ON position configures the channel for current input. A switch in the OFF position configures the channel for voltage input.

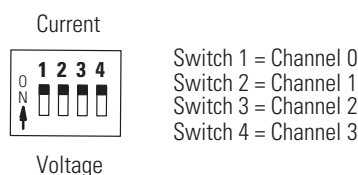

## Switch Settings for the 1746-NIO4I and -NIO4V

The NIO4I and NIO4V have 2 individual switches labeled 1 and 2. These switches control the input mode of input channel 0 and 1. A switch in the ON position configures the channel for current input. A switch in the OFF position configures the channel for voltage input.

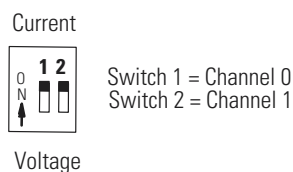

## External Power Switch for the 1746-NO4I and -NO4V

The NO4I and NO4V analog output modules have an external 24V dc power switch, SW1, which gives you the option of using an external power supply. In the UP position, power is drawn from an external power source. In the DOWN position, power is drawn from the backplane of the module. The switch is located on the analog module board. Switch orientation is also provided on the nameplate of the module.

The 24V dc user power connection on a fixed SLC 500 can power an NO4I or NO4V analog module. However, the regulation of the 24V dc user connection on a modular SLC 500 power supply, Catalog Number 1746-P1, -P2, is outside of the requirements of the NO4I and NO4V analog modules and cannot be used.

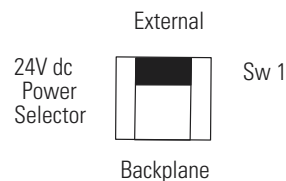

## Choosing a Slot in the Chassis

Two factors determine where the analog module should be located in the chassis: ambient temperature and electrical noise. Consider the following conditions when selecting a slot for an analog module.

Position the module:

- in a slot away from ac or high voltage dc module
- in the chassis closest to the bottom of the enclosure where the SLC 500 system is installed
- away from the chassis power supply if installed in a modular system

## Installing Your Module

All modules are mounted in a single slot. Remember that in a modular system the processor always occupies the first slot of the first chassis.

When installing the analog module in a chassis, it is not necessary to remove the terminal block from the module. However, if the terminal block is removed, use the write-on label located on the side of the terminal block to identify the module location and type.

**ATTENTION**

Never install, remove, or wire modules with power applied to the chassis. Also, do not expose analog modules to surfaces or other areas that may typically hold an electrostatic charge. Electrostatic charges can destroy the analog circuitry.

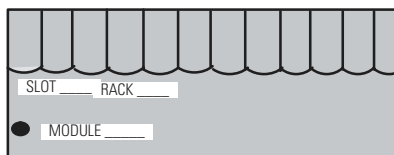

## Removing the Analog Module Terminal Block

To remove the terminal block, grasp it on the top and bottom and pull outward and down.

**IMPORTANT**

The potentiometer sets the voltage during factory calibration to 2.5 volts. It is set and sealed at the factory and does not require any adjustments.

1. Verify that all switches are set correctly for the application.

**ATTENTION**

Care should be taken to avoid connecting a voltage source to a channel configured for a current input.

2. Align the circuit board of the analog module with the card guide of the chassis.
3. Slide the module in until both top and bottom retaining clips are secured.

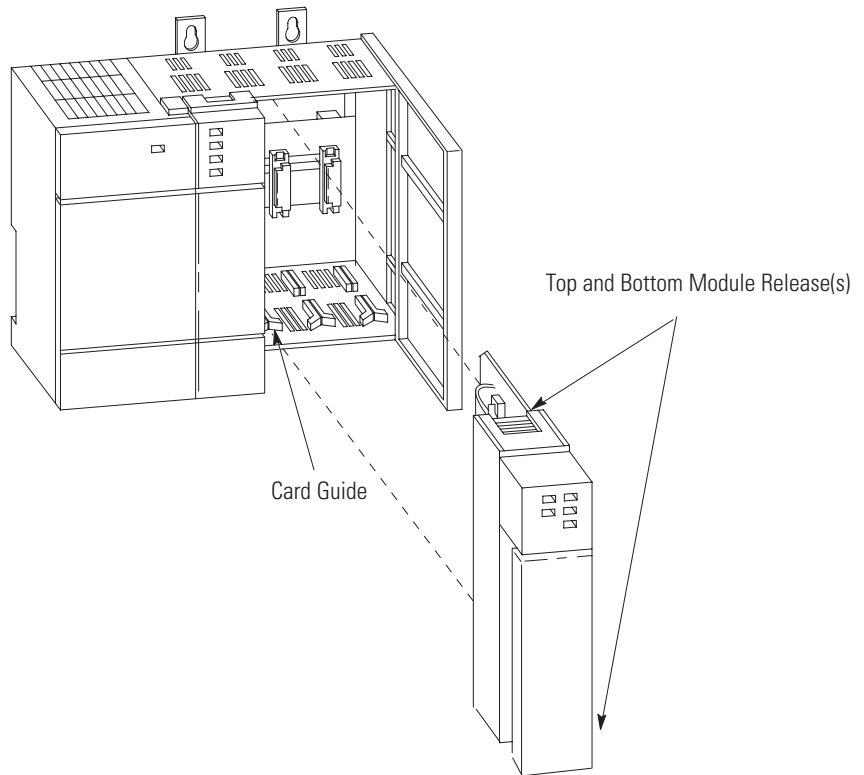

4. To remove the module, depress the retaining clips at the top and bottom of the module and slide the module out.

## Wiring Considerations

The following section provides system wiring guidelines, how to ground your Belden cable, and how to determine the cable length.

---

**ATTENTION**



Before wiring any analog module, disconnect power from the SLC 500 system and from any other source to the analog module.

---

---

## System Wiring Guidelines

Use the following guidelines in planning the system wiring for the analog modules:

- all analog common terminals (ANL COM) are electrically connected inside the module. ANL COM is *not* connected to earth ground inside the module.
- voltages on IN+ and IN- terminals must remain within  $\pm 20$  Volts with respect to ANL COM to ensure proper input channel operation. This is true for current and voltage input channel operation.
- voltage outputs (OUT 0 and OUT 1) of the NIO4V and NO4V are referenced to ANL COM. Load resistance (R1) for a voltage output channel must be equal to or greater than 1K ohms.
- current output channels (OUT 0 and OUT 1) of the NIO4I and NO4I source current that returns to ANL COM. Load resistance (R1) for a current output channel must remain between 0 and 500 ohms.

## Grounding Your Cable

Belden cable #8761 has two signal wires (black and clear), one drain wire and a foil shield. Refer to the illustration on p. 3-10. The drain wire and foil shield must be grounded at one end of the cable. *Do not* earth ground the drain wire and foil shield at *both* ends of the cable.

**Input Channel** - Use a chassis mounting tab as a ground for the drain wire and foil shield.

**Output Channel** - Ground the drain wire and foil shield at the analog load.

---

**IMPORTANT**

If you cannot ground the output channel at the load, ground the drain wire and foil shield at the chassis mounting tab. Do not connect the foil shield or drain wire to the analog terminal block. They must be connected to an earth ground, which is not provided at the analog module.

---

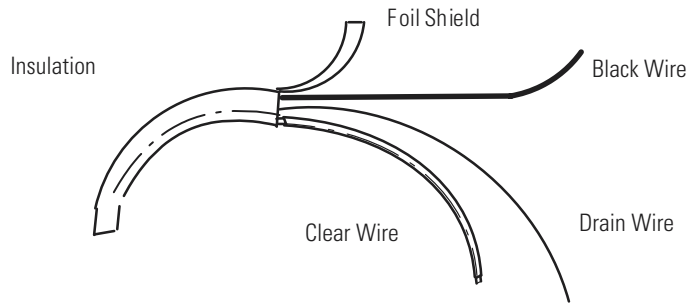

### Determining the Cable Length

Determine the length of cable you will need to connect a channel to its input or output device. Remember to leave additional length to route the drain wire and foil shield for earth grounding.

## Wiring the Analog Module

After the analog module is properly installed in the chassis, use the following wiring procedure. Belden cable #8761 is recommended when wiring analog modules. This section assumes that you have properly installed the analog module.

---

**ATTENTION**

Before wiring any analog module, disconnect power from the SLC 500 system and from any other source to the analog module.

---

To wire your analog module follow these steps and refer to the illustrations on the next page.

1. Designate the end of the cable where the drain wire and foil shield is earth grounded as END 1. Designate the other end as END 2.
2. At each end of the cable strip some casing to expose the individual wires.
3. Trim the signal wires to 2 inch lengths. Strip about 3/16 inch (4.76mm) of insulation away to expose the end of the wire.
4. At End 1, twist the drain wire and foil shield together, bend them away from the cable, and apply shrink wrap.



5. At End 2, cut the drain wire and foil shield back to the cable and apply shrink wrap.
6. Connect the signal wires (black and clear) to the terminal block and the input and output devices. The recommended maximum torque is 5 lb.-in (0.565 NM) for all terminals.
  - If the foil shield and drain wire of the channel are grounded at the sourcing device, make sure End 2 of the cable is connected to the terminal block.
  - If the foil shield and drain wire are grounded at the chassis mounting tab, make sure End 1 is connected to the terminal block.
7. Repeat steps 1 through 6 for each channel on the analog module. Jumper the unused plus (+), minus (-) and common terminals of each input channel individually. Unused output and common terminals should be left unconnected.

The following illustrations depict the proper cable preparation for END 1 and END 2. Shrink wrap is applied to each cable end. Make sure the foil shield and drain wires on END 1 are long enough to reach their designated earth ground points.

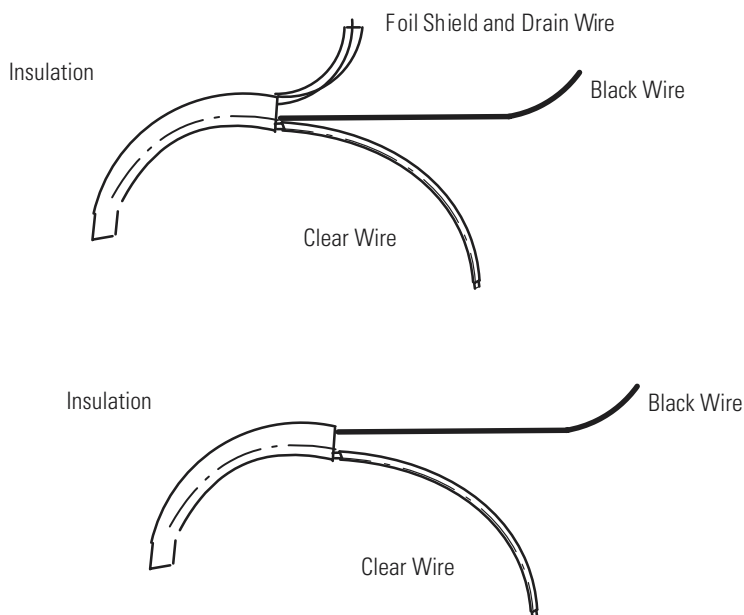

## Labeling and Installing the Terminal Block

The terminal block has a write-on label. Labeling the terminal block will help ensure that it is installed on the correct module.

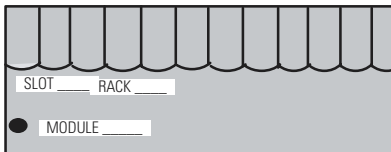

Note: The black dot on the terminal block label indicates the position of terminal 0.

Once you have wired your analog module and properly labeled the terminal block, install the terminal block on the analog module. To install the terminal block:

1. Align the terminal block with the receptacle.
2. Insert the terminal block and press firmly at the top and bottom until it is properly secured.

## Grounding the Foil Shields and Drain Wires

You are now ready to earth ground your foil shield and drain wire from each cable. Do not connect the foil shield or drain wire to the analog module terminal block. The foil shield and drain wire *must be* connected to earth ground, which is not available on the terminal block. Refer to the illustration on the next page for wiring diagrams of the analog modules.

N14

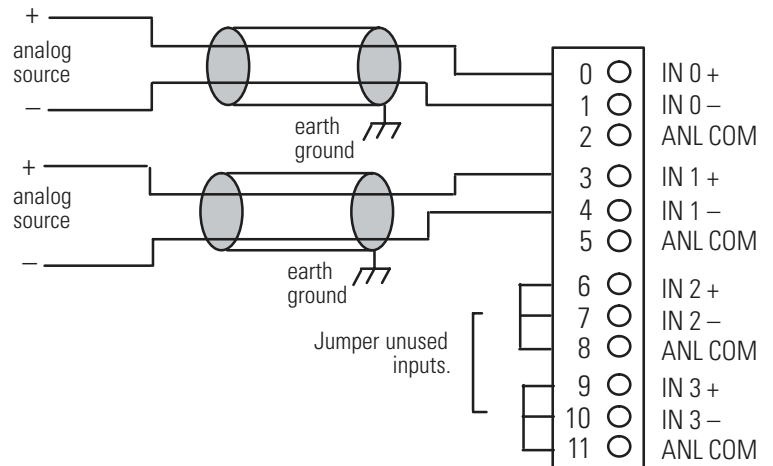

N104I & N104V

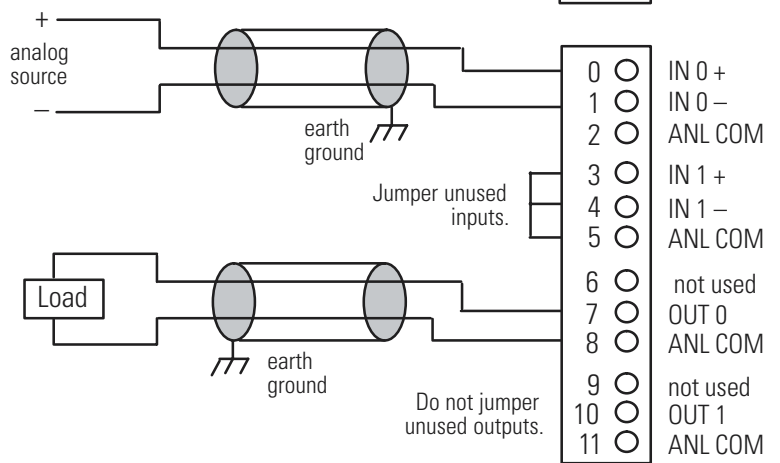

N04I & N04V

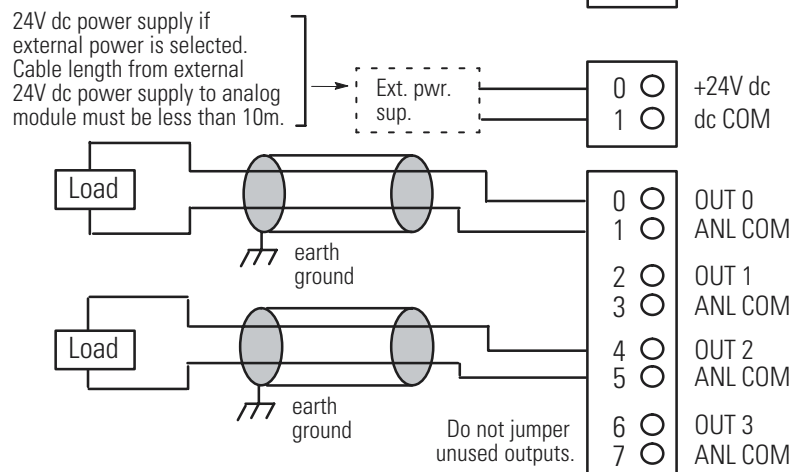

Analog commons are internally connected in the module. Channels are not isolated from each other.

## Wiring Schematics for 2, 3, and 4-Wire Analog Input Devices

**Important:** The module does *not* provide loop power for analog inputs.  
Use a power supply that matches the transmitter specifications.

2-Wire Transmitter

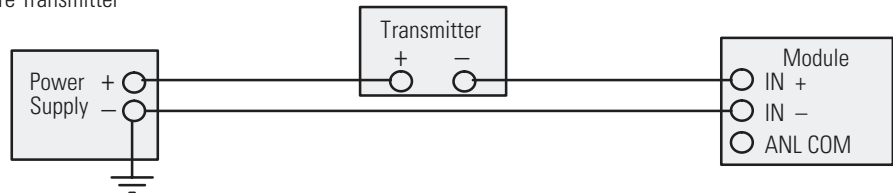

3-Wire Transmitter

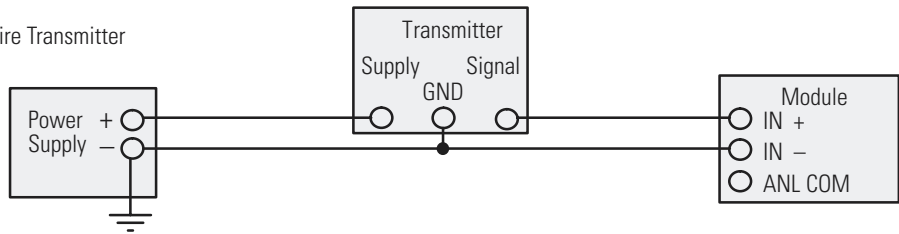

4-Wire Transmitter

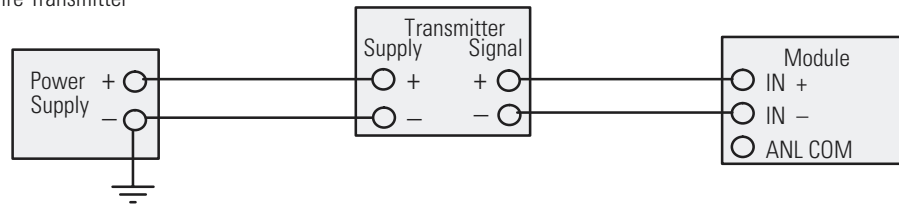

## Wiring Schematic for Single-ended Analog Input Connections

When wiring single-ended analog input devices to the analog input card, the number of total wires necessary can be limited by using the ANALOG COMMON terminal. Note that differential inputs are more immune to noise than single-ended inputs.

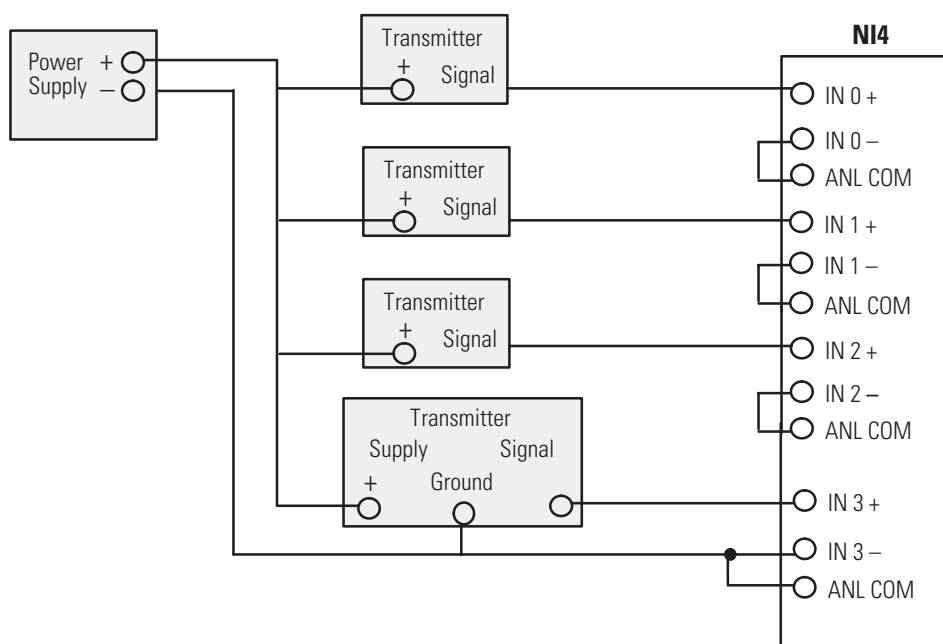

## Minimizing Electrical Noise on Analog Modules

Inputs on analog modules employ digital high frequency filters that significantly reduce the effects of electrical noise on input signals. However, because of the variety of applications and environments where analog modules are installed and operating, it is impossible to ensure that all environmental noise will be removed by the input filters.

Although it is not the purpose of this manual to address SLC 500 system procedures, several specific steps can be taken to help reduce the effects of environmental noise on analog signals:

- install the SLC 500 system in a properly rated (i.e., NEMA) enclosure. Make sure that the SLC 500 system is properly grounded.
- use Belden cable #8761 for wiring the analog modules making sure that the drain wire and foil shield are properly earth grounded.
- route the Belden cable separate from any other wiring. Additional noise immunity can be obtained by routing the cables in grounded conduit.

- group analog and low voltage dc modules away from ac I/O or high voltage dc modules.

A system may malfunction due to a change in the operating environment after a period of time. We recommend periodically checking system operation, particularly when new machinery or other noise sources are installed near the SLC 500 system. For further details on system installation and startup refer to:

- *SLC 500 Modular Hardware Style User Manual* (publication 1747-UM011)
- *SLC 500 Fixed Hardware Style Installation & Operation Manual* (publication 1747-6.21)
- *Safety Guidelines for the Application, Installation Maintenance of Solid State Control* (A–B Publication SGI–1.1).

## Module Operation and System Considerations

This chapter describes:

- Interface between the Module and Processor
- System Considerations

### Interface between the Module and the Processor

This section describes how to set up an analog module in a SLC 500 system.

#### Entering Module ID Codes

When configuring an analog module for an SLC 500 system using your programming software, a list of the different I/O modules, including the analog modules, is most likely provided for you. If a list is not provided, you need to enter the module identification code when configuring the slot. Refer to the table below for the appropriate analog module ID code.

Using the Hand-Held Terminal (HHT) firmware v1.1, enter the proper MODULE ID CODE under the “other” selection. Version 2.0 or later of the HHT firmware provides a list of I/O modules. Refer to the following publications for complete information:

- your programming software’s user manual
- the Hand-Held Terminal User Manual

<b>Catalog No.</b>	<b>Module ID Code</b>
1746-NI4	4401
1746-NIO4I	3201
1746-NIO4V	3202
1746-NO4I	5401
1746-NO4V	5402

## Addressing Analog Modules

**NI4** - Each input channel of the NI4 is addressed as a single word in the input image table. The NI4 uses a total of 4 words in the input image table. The converted values from channels 0 through 3 are addressed as input words 0 through 3 respectively for the slot where the module resides.

---

**EXAMPLE**

If you want to address input channel 2 of the NI4 in slot 4, you would address it as input word 2 in slot 4 (I:4.2).

---

**NIO4I and NIO4V** - Each input channel of the NIO4I and NIO4V is addressed as a single word in the input image table and each output channel of the module is addressed as a single word in the output image table. Both the NIO4I and NIO4V use a total of 2 input words and 2 output words.

The converted input values from input channels 0 and 1 are addressed as words 0 and 1 of the slot where the module resides. The output values for the output channels 0 and 1 are addressed as output words 0 and 1 of the slot where the module resides.

---

**EXAMPLE**

If you want to address output channel 0 of the NIO4I in slot 3, you would address it as output word 0 in slot 3 (O:3.0).

---

**NO4I and NO4V** - Each output channel of the NO4I and NO4V is addressed as a single word in the output image table. Both modules use a total of 4 output words. The converted output values from output channels 0 through 3 are addressed as words 0 through 3 respectively for the slot where the module resides.

---

**EXAMPLE**

If you want to address output channel 3 of the NO4I in slot 3, you would address it as output word 3 in slot 3 (O:3.3).

---



The following illustration shows I/O addressing for the analog modules.

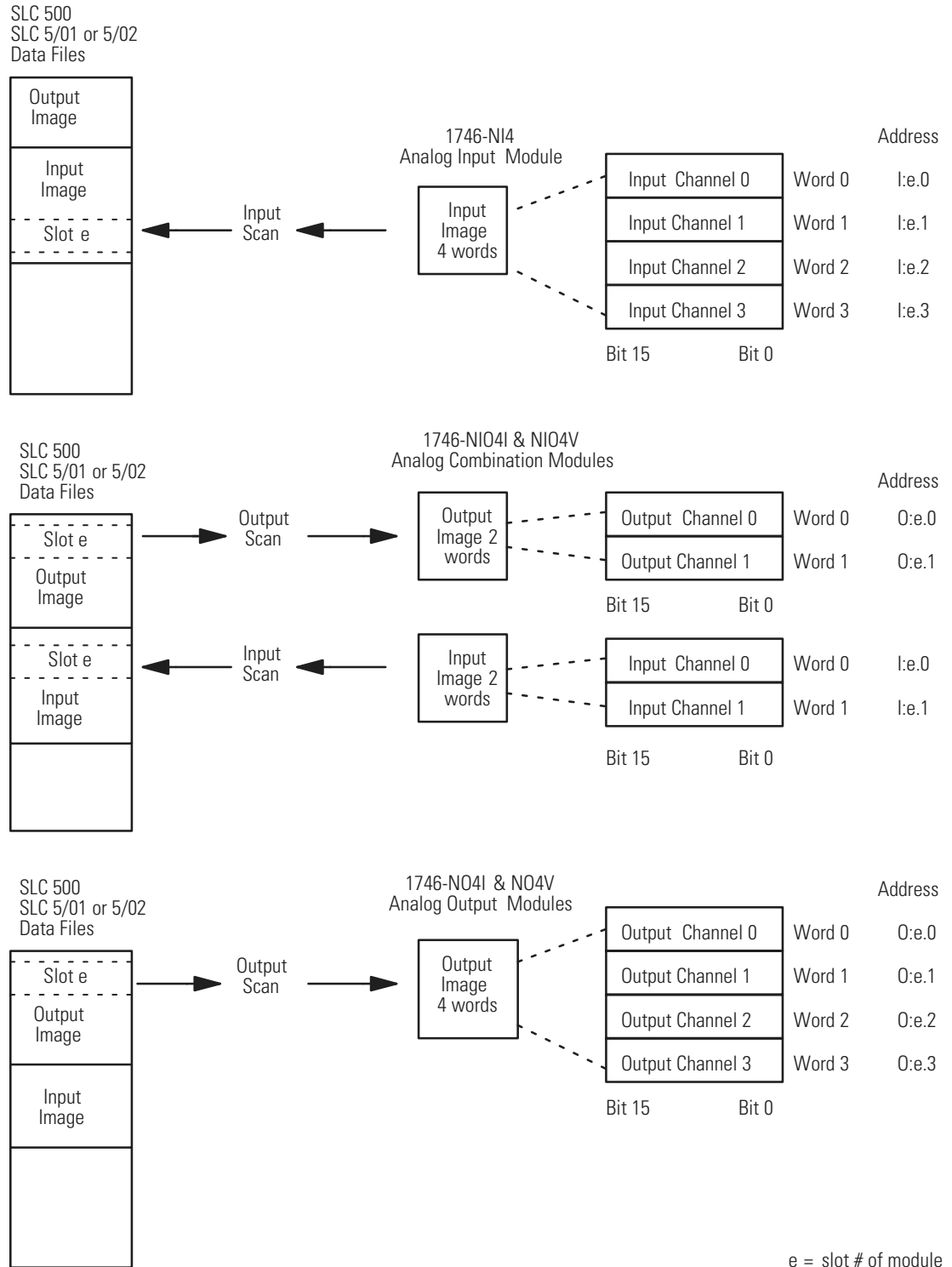

### Bit Level Addressing

The following bit maps show bit level addressing for the analog inputs and outputs. The input channel converter resolution is 16 bits, or 1 word. The output channel converter resolution is 14 bits and is loaded from the most significant 14 bits of the associated output word.

The two least significant bits (O:e.0/0 and O:e.0/1) of the output word have no effect on the actual output value.

1746-NI4

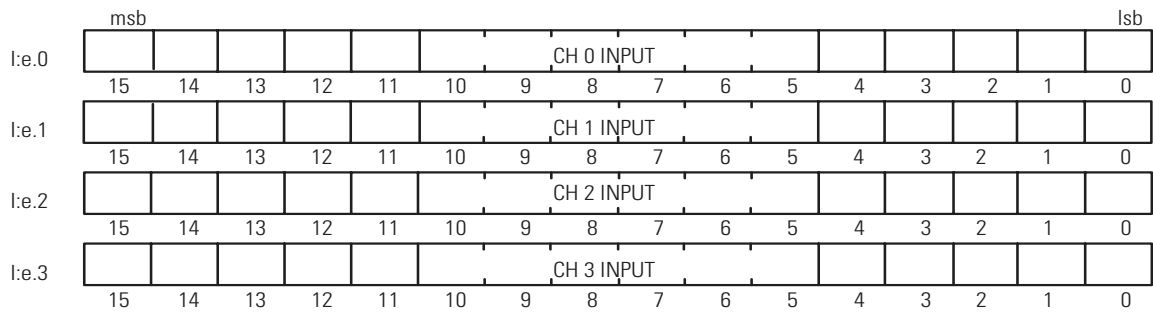

1746-NIO4I & NIO4V

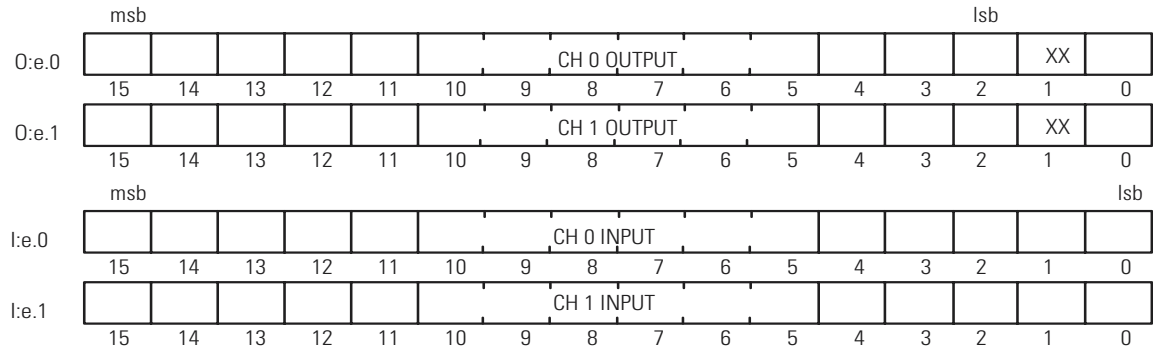

1746-NO4I & NO4V

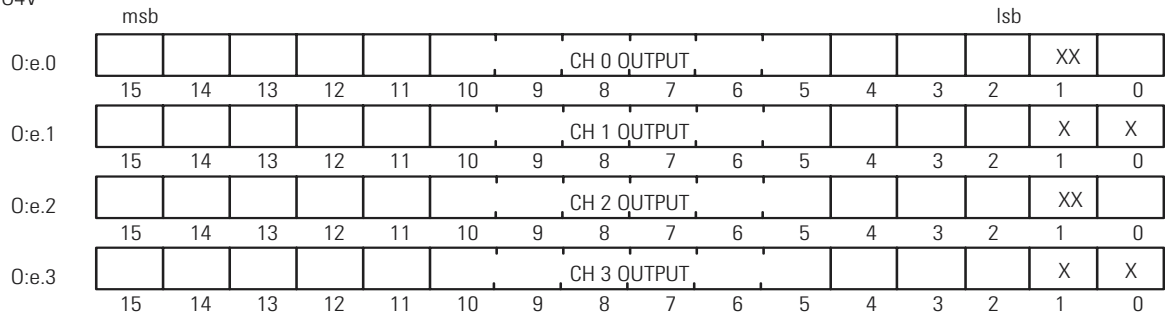

e = slot # of module  
 x = bit not used

## Processor Update of Analog Data

The analog input and output data is updated by the processor once during each scan of the user program. The table below shows typical analog update scan times and the number of input and output bits for the specified modules.

If an application requires processor updates of the analog data more frequently than once per scan, use an Immediate Input or an Immediate Output instruction. An Immediate Input or Output instruction typically updates 16 bits (or 1 analog channel) in 1 millisecond.

Refer to your programming software's user manual for more information.

### Typical Time for Analog Data Updates to the Processor's Input and Output Image

Once per processor scan (Automatic)	10 milliseconds for typical 1K program
Using immediate Input or Output Instruction	1 millisecond per analog channel

### Number of Input and Output Bits Representing Analog Data

Description	Input Bits	Output Bits
NI4	64	-
NI4OI and NIO4V (2 input and 2 Output channels)	32	32
NO4I and NO4V	-	64

## Monitoring the Input and Output Data

The analog input and output data can be monitored in several different radices using your programming software. Viewing the radix as decimal allows the analog input and output data to be viewed as decimal representations of integer words.

When monitoring in binary radix, data is viewed in two's complement representation for negative values. A description of two's complement data is available in Appendix B.

If you are using the Hand-Held Terminal (HHT) or the Data Table Access Module™ (DTAM) to monitor input and output data, the binary radix is the only available option. To view the analog input and output data in decimal radix, the data must be moved to an integer data file.

## Converting Analog Input Data

Analog inputs convert current and voltage signals into 16 bit two's complement binary values.

The table below identifies the current and voltage input ranges for the input channels, the number of significant bits for the applications using input ranges less than full scale, and their resolution

Voltage/Current Range	Decimal Representation	Number of Significant Bits	Resolution per LSB
-10V dc to +10V dc - 1LSB	-32,768 to +32,767	16 bits	305.176 $\mu$ V
0 to 10V dc - 1LSB	0 to 32,767	15 bits	
0 to 5V dc	0 to 16,384	14 bits	
1 to 5V dc	3,277 to 16,384	13.67 bits	
-20 mA to +20 mA	-16,384 to +16,384	15 bits	1.22070 $\mu$ A
0 to +20 mA	0 to 16,384	14 bits	
4 to +20 mA	3,277 to 16,384	13.67 bits	

To determine an approximate voltage that an input value represents, use one of the following equations:

$$\frac{10V}{32,768} \times \text{input value} = \text{input voltage(V)}$$

The Input Value is the decimal value of the word in the input image for the corresponding analog input.

For example, if an input value of  $\pm 16,021$  is in the input image, the calculated input voltage is:

$$\frac{10V}{32,768} \times \pm 16,201 = \pm 4.889221(V)$$

It should be noted that this is the calculated value. The actual value may vary within the accuracy limitations of the module.

To determine an approximate current that an input value represents, you can use the following equation:

$$\frac{20 \text{ mA}}{16,384} \times \text{input value} = \text{input current (mA)}$$

The Input Value is the decimal value of the word in the input image for the corresponding analog input.

For example, if an input value of 4096 is in the input image, the calculated input current is:

$$\frac{20 \text{ mA}}{16,384} \times 4096 = 5(\text{mA})$$

It should be noted that this is the calculated value. The actual value may vary within the accuracy limitations of the module.

## Converting Analog Output Data

Analog outputs convert a 16-bit two's complement binary value into an analog output signal. Because the analog output channels have a 14-bit converter, the 14 most significant bits of this 16-bit number are the bits that the output channel converts.

The NIO4I and NO4I support two and four current outputs respectively, ranging from 0 mA to a maximum of 21 mA. The NIO4V and NO4V support two and four voltage outputs respectively, ranging from -10 to +10 Volts dc.

The following tables identify the current and voltage output ranges for the output channels, the number of significant bits for the applications using output ranges less than full scale, and their resolution.

Current Range	Decimal Representation for Output Word	Number of Significant Bits	Resolution per LSB
0 to 21 mA - 1LSB	0 to +32,764	13 bits	2.56348 $\mu$ A
0 to +20 mA	0 to +31,208	12.92 bits	
4 to +20 mA	6,242 to +31,208	12.6 bits	

Voltage Range	Decimal Representation for Output Word	Number of Significant Bits	Resolution per LSB
-10 to +10V dc - 1LSB	-32,768 to +32,764	14 bits	1.22070 mV
0 to +10V dc - 1LSB	0 to +32,764	13 bits	
0 to 5V dc	0 to +16,384	12 bits	
1 to 5V dc	+3,277 to +16,384	11.67 bits	

Use the following equation to determine the decimal value for the current output:

$$\frac{32,768}{21 \text{ mA}} \times \text{Desired Current Output (mA)} = \text{Output Decimal V alue}$$

For example, if an output value of 4 mA is desired, the value to be put in the corresponding word in the output image can be calculated as follows:

$$\frac{32,768}{21 \text{ mA}} \times 4 \text{ mA} = 6242$$

Note: The actual resolution for analog current outputs is 2.56348 µA per LSB, where the LSB position in the output word is indicated as:

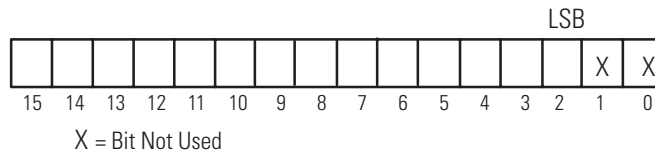

Use the following equation to determine the decimal value for the voltage output:

$$\frac{32,768}{10 \text{V dc}} \times \text{Desired Voltage Output (V dc)} = \text{Output Decimal V alue}$$

For example, if an output value of 1V dc is desired, the value to be put in the corresponding word in the output image can be calculated as follows:

$$\frac{32,768}{10 \text{V dc}} \times 1 \text{V dc} = 3277$$

Note: The actual resolution for analog voltage outputs is 1.22070 mV per LSB, where the LSB position in the output word is indicated as:

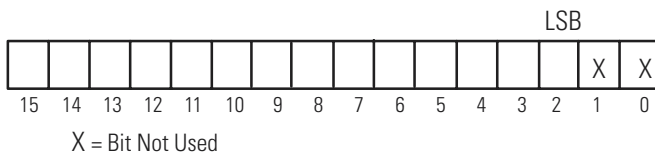

## System Considerations

This section describes the system considerations for an analog module. These include:

- safe state for outputs
- retentive programming
- input out-of-range detection
- response to slot disable
- input channel filtering

### Safe State for Outputs

Whenever an SLC 500 system is NOT in the RUN mode, the outputs on the analog module are automatically forced to 0 Volts or 0 mA by the SLC 500 system. This occurs when the processor is in the:

- FAULT mode
- PROGRAM mode
- TEST mode

---

**ATTENTION**

When designing and installing the SLC 500 system, devices connected to the analog module output channels must be placed into a safe state whenever the analog output is 0 volts or 0 mA ( $\pm$  the offset error).

---

### Retentive Programming Option

This section describes the affects of a processor mode change on analog outputs. The following information applies to the 1746-NIO4I, NIO4V, NO4I and NO4V analog modules.

This programming option allows you to retain analog data in the Input and Output Image tables when the SLC 500 processor:

- transitions from RUN-PROGRAM-RUN mode OR
- when power is turned OFF and reapplied

In both cases, when power is reapplied, the data is transferred to the module whether the programming rung is true or false.

If an SLC 500 system detects a fault condition, the analog outputs reset to zero. The data in the Output Image table is retained during the

fault. Once the fault condition is corrected and the major fault bit in the processor is cleared, the retained data is sent to the analog output channels.

If you choose not to use the retentive programming option, retained data is not sent to the output channels.

The following section provides example program options for retentive data and non-retentive data.

### Retentive Analog Output Example

If a modular system is configured with the CPU in slot 0, a discrete I/O module in slot 1, and an analog output module in slot 2 the following ladder logic rung can be programmed.

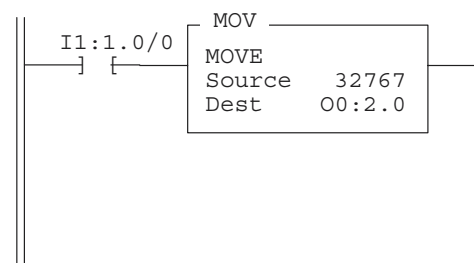

When bit 0 of the discrete I/O module turns ON, the rung is true and the value 32767 is moved into the Output Image table location that corresponds with analog output channel 0 in slot 2. At the end of the scan, this value is transferred to the module where it is converted to the appropriate voltage or current (depending on the type of module used).

If on the next program scan the rung becomes false, the MOVE of the value of 32767 to the Output Image table does not occur. Unless another rung is added to transfer data to the Output Image based on this rung being false, the previous data is retained. That is, the value 32767 remains in the Output Image table and is transferred to the analog module at the end of subsequent program scans until changed by the user program.



### Non-Retentive Analog Output Example

The following example shows a non-retentive program during a program execution and for a mode change or power cycle.

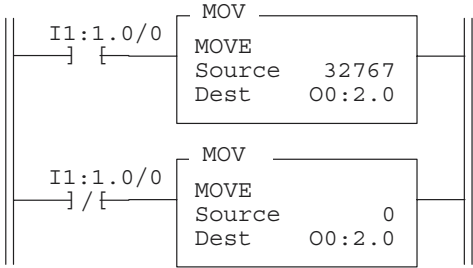

In the above example, as long as discrete input 0 is ON, the value 32767 is transferred to analog output channel 0. If discrete input 0 turns OFF, the value 0 is transferred to analog output channel 0.

### During a Mode Change or Power Cycle

The first pass bit in the Status File is used to initialize the analog output following a power up in the RUN mode or entry into the RUN or TEST mode. The address of the First Pass bit is S2:1/15. When this bit is ON, the first pass of the program scan is taking place. Therefore, the following ladder rung can be programmed to always clear the analog output channel during the first program scan.

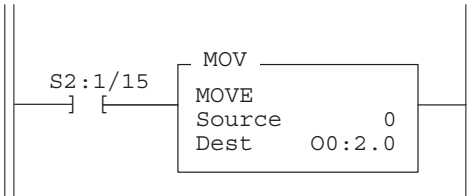

### Input Out-of-Range Detection

Analog modules do not provide an input out-of-range signal to the processor. However, if this feature is critical to a specific application, you can program the processor to provide this function.

The following program applies to all SLC 500 processors. The program shows two compare instructions that check for analog input values

which exceed low and high limits respectively. For this example, the analog input value is in word 1 of slot 1 (I1:1.1). Whenever the input value exceeds a limit, this program latches a binary variable in memory that could serve as an alarm indication at some other point in the program.

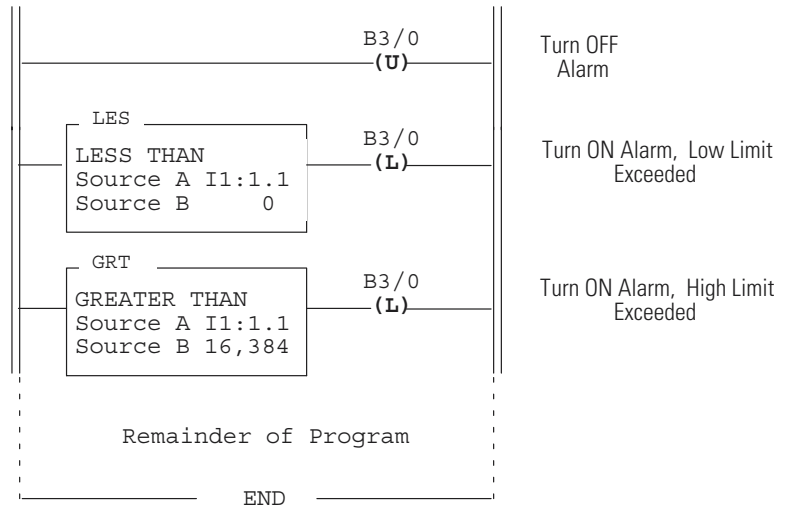

The second program is for SLC 5/02 processors. This program uses the Limit Test instruction that checks both low and high limits in a single instruction. This instruction assumes that the analog input value is in word 1 of slot 1 (I1:1.1).

As in the above program, whenever the input value exceeds a limit, this program latches a binary variable in memory which could serve as an alarm indication at some other point in the program.

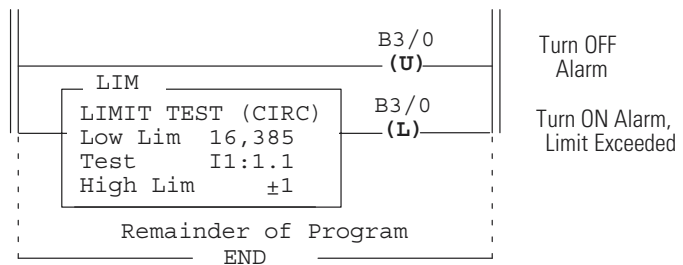

## Response to Slot Disable

You have the ability to disable any slot in the chassis using the processor. Before disabling any slot containing an analog module, it is important to consider how the analog module will respond when the slot is disabled.

---

**ATTENTION**

Make sure that the implications of disabling an analog module slot are clearly understood before utilizing this feature.

---

The response to slot disable for inputs and outputs is the same for all the analog modules.

## Input Response to Slot Disable

The module continues to update the input values to the processor. However, the processor does not read inputs from a module that is disabled. Therefore, when the processor disables the analog module slot, the module inputs appearing in the processor image table remain in their last state. When the processor re-enables the analog module slot, the current state of the module inputs are received by the processor during the subsequent scan.

## Output Response to Slot Disable

The processor may change the analog module output data as it appears in the processor image table. However, this data is not transferred to the analog module.

Instead, the analog module holds its outputs in their last state. When the slot is re-enabled, the data that appears in the processor image table is transferred to the analog module on the subsequent scan.

## Input Channel Filtering

The input channels for all of the analog modules incorporate extensive on board signal conditioning. The purpose of this conditioning is to reject the high frequency noise that can couple into an analog input signal while passing the normal variations of the input signal. The conditioning is performed by passing the input signal through a 6 pole Gaussian digital filter.

The sharp cut-off of this filter is demonstrated in the frequency response plot shown below. Frequency components of the input signal at or below the filter corner frequency of 10 Hz are passed with under 3 dB of attenuation. This pass band allows the normal variation of sensor inputs such as temperature, pressure and flow transducers to be input data to the processor.

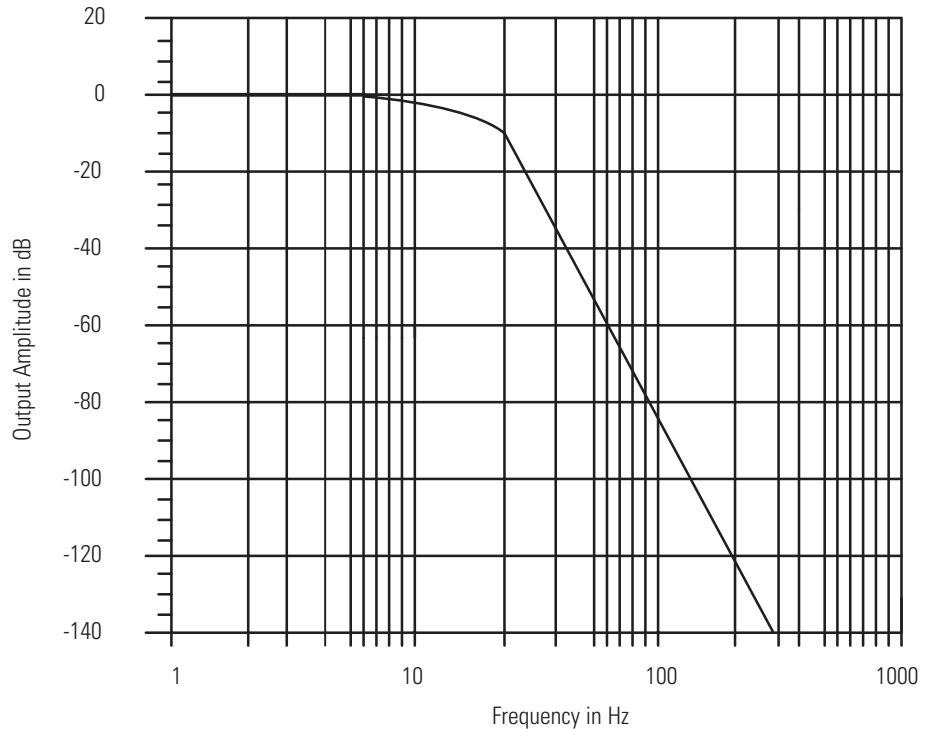

Noise signals coupled in at frequencies above the 10 Hz pass band is sharply rejected. An area of particular concern is the 50/60 Hz region, where pick up from power lines can occur. From the frequency response diagram, you see that a 60 Hz signal on the plus (+) input with respect to the minus (-) input is attenuated by over 55 dB (60 Hz normal mode rejection).

If power line noise is coupling into the input signal through the input cable, the proper use of differential inputs reduces the effect of noise. With differential inputs, noise couples into both the plus (+) and minus (-) inputs where it is attenuated by over 105 dB (60 Hz common mode rejection).

The affect of the filter with respect to time can be seen by examining the step response of the input channel. The following illustration shows the response of the input value versus time when a step change is made in the voltage or current at the input terminal. The response of the filter demonstrates no overshoot and rapid settling time. The input value settles to within 95% of the final value in 60 milliseconds, independent of the input magnitude.

**EXAMPLE** If the input instantaneously changes from 0 to 10 volts, the value converted by the analog module after 60 milliseconds is 9.5 volts. Within this time the analog module updates the input data value in memory with an intermediate response every 512 microseconds.

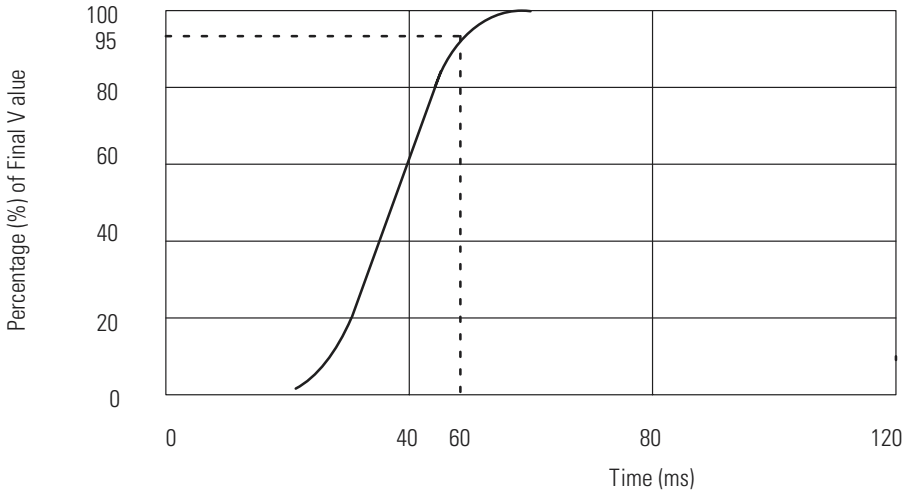



## Testing Your Module

The purpose of this chapter is to help you isolate problems in a systematic and controlled manner before beginning normal system operation.

If your analog module is installed in the expansion chassis of a fixed system, test your system using the procedures described in the *SLC 500 Fixed Hardware Style Installation & Operation Manual* (publication 1747-6.21) before executing the analog module start up procedures.

### Testing the SLC 500 System

If your analog module is installed in a modular system, test the modular system using the procedures described in the *SLC 500 Modular Hardware Style User Manual* (publication 1747-UM011) before executing the analog module start up procedures.

### Start-up Procedures

Once you have tested your SLC 500 system, follow the steps below in sequence to test your analog module:

1. Inspect the analog module.
2. Disconnect prime movers.
3. Power up the SLC 500 system.
4. Test the analog inputs.
5. Test the analog outputs.
6. Start up the system.

## Inspect the Analog Module

Problems can be prevented by inspecting the analog module before installing it in the SLC 500 system. Inspection should include the following steps:

1. Make sure that all voltage/current mode selection DIP switches are set properly (inputs only).
2. Make sure that all analog module wiring connections are correct and that there are no missing or broken wires. Check the tightness of all terminals to make certain wires are secure.

---

**ATTENTION**

Care should be taken to avoid connecting a voltage source to a channel configured for a current input. Improper module operation or damage to the module can occur.

- 
3. Make sure that the shield for the cable used to wire the analog module is properly grounded. Refer to chapter 3 for additional information.

---

**ATTENTION**

**Do not** connect the Belden #8761 foil shield and drain wire to the analog module terminal block. The foil shield and drain wire must be connected to earth ground, which is not available on the analog module terminal block.

- 
4. Make certain that the removable terminal block on the analog module is secured on the module.

## Disconnect Prime Movers (Motion Devices)

During the following test procedures the processor is energized. As a safety precaution, make sure that machine motion does not occur. To achieve this:

- Disconnect the motor wires at the motor starter or the motor itself. This allows you to test the operation of the starter coil, verifying that your output circuit is wired correctly and functioning.
- To disconnect a solenoid, disengage the valve, leaving the coil connected.



In some instances, you may not be able to disconnect a device the preferred way. In these cases, open the output circuit at a point as close as possible to the motion-causing device. For example, your output might be a relay coil which in turn energizes a motor starter. If you cannot disconnect the motor wires, open the circuit at a point between the motor starter and the relay contact.

**ATTENTION**

Machine motion during system checkout can be hazardous to personnel. During all checkout procedures, you must disconnect all devices which, when energized, might cause machine motion.

## Power Up the SLC 500 System

Apply power to the fixed or modular system. The analog module LED (red) should be illuminated, indicating that the module is receiving 24V dc power.

While an illuminated analog module LED does not ensure that the module is operating properly, a non-illuminated LED indicates that the analog module is not functional. Do not continue with the test procedures until the LED is illuminated.

The four most probable causes of a non-illuminated LED are:

- The SLC 500 system is not receiving power from its power supply. Check the POWER LED on the fixed system unit or the power supply on the modular system. If the LED is not illuminated, refer to the *Fixed Hardware Style Installation & Operation Manual* (publication 1747-6.21) or the *Modular Hardware Style User Manual* (publication 1747-UM011). If the module is a 1746-NO4I or NO4V, check the state of the optional 24V dc power switch. If external power is selected, but not connected to the front of the module, the power LED will not illuminate.
- The power from the supply is not being received by the remainder of the SLC 500 system. You can test this by attempting to go online with the programming device.
- The slot in the chassis where the analog module is located is not operational. Remove the power from the SLC 500 system, move the analog module to another slot and restore power. If it appears that the slot is defective, replace the chassis.
- The analog module is defective.

## Testing Analog Inputs

Before testing the analog module input channels, the SLC 500 system must be installed and tested according to the *SLC 500 Fixed Hardware Style Installation & Operation Manual* (publication 1747-6.21) or the *SLC 500 Modular Hardware Style User Manual* (publication 1747-UM011). The processor must be connected to a programming device, properly configured, and must have no rungs in its ladder program. The analog module LED must also be illuminated.

---

**ATTENTION**

The procedure described in this section for testing analog module input channels assumes that all I/O module outputs that normally activate prime movers or other potentially dangerous devices have been disconnected from these devices.

**Do not** attempt to test the analog module input channels unless prime movers and/or other potentially dangerous devices are disconnected from the I/O modules.

---

The devices connected to the analog module input channels are referred to as “sensors.” If the sensors can be manually varied over their normal operating range, use these devices to test the analog module input channels.

If the sensors cannot be manually varied, a voltage source or current source is necessary to test the input channels. In this case, disconnect the analog module input channels at the sensor to test the terminal block wiring. The following information applies to either test procedure.

---

**IMPORTANT**

The following procedure does not ensure that the input mode DIP switch is properly configured. Visually inspect the input mode DIP switch before installing the analog module in the chassis.

---

**ATTENTION**

Care should be taken to avoid connecting a voltage source to a channel configured for a current input. Improper module operation or damage to the module can occur.

---

To test the analog inputs follow these steps:

1. Determine the boundary conditions for the analog module input channel. For example, if the input channel is connected to a sensor that has an output range of 1 mA to 5 mA, the boundary conditions would be 1 mA (lower) and 5 mA (upper).
2. Using the formulas from page, calculate the input decimal values that should appear in the processor image table when the boundary conditions are present on the analog module input channel.

For example, if 1 mA and 5 mA are boundary conditions, the decimal values would be 819 and 4096.

3. Assuming that the programming device is on-line with the processor, select the test mode and continuous scan mode function.
4. Display the data in File 1 (Input Image Table).
5. Change the radix of the display to decimal.
6. If the input channel of the module has been disconnected from its sensor, attach a voltage source (voltage input) or current source (current input) to the input and set the source to the *lower boundary* condition.

If the input channel is connected to its sensor, set the sensor to its lower boundary condition.

7. Locate the input channel image data in the image table. The input image word for the input channel being tested should read approximately the lower boundary calculated in step 2.

The exact value of the image word is affected by the accuracy of the analog module and the input sensor. Ensure that the deviation from the boundary value is within tolerances for the analog application.

8. If the input channel has been disconnected from its sensor, attach the voltage source (voltage input) or current source (current input) to the input and set the source to the *upper boundary* condition.

If the input channel is connected to its sensor, set the sensor to its upper boundary condition.

9. Repeat step 7 for the upper boundary condition.

10. Repeat steps 1 through 8 for the remaining analog inputs.
11. If any of the analog input channels do not pass the start-up procedure, check for the following potential causes:
  - The processor is not in the TEST/CONTINUOUS scan mode.
  - The terminal block is not secured on the analog module.
  - The analog module terminal block is not wired properly or wires are broken. See chapter 3 for details on wiring the analog module.
  - The analog module input channel sensor (or test voltage or current source) is not operating properly.

If a current source is not available to test a current input channel, a test voltage can be applied to the current input channel to achieve the input boundary conditions. In normal operation, a voltage source should not be connected to an analog input channel in the current mode. To determine the boundary conditions use the following equation:

$$\text{Voltage Input (V)} = \text{Current Input (mA)} \times 0.25$$

---

**EXAMPLE**

If the current input boundary conditions are 1 mA and 5 mA, the boundary conditions in volts would be 0.25 volts and 1.25 volts. If this calculation is done correctly, the test voltage should never exceed 5 volts.

---

## Testing Analog Outputs

Before testing the analog module output channels, the SLC 500 system must be installed and tested according to the *SLC 500 Modular Hardware Style User Manual* (publication 1747-UM011) or the *SLC 500 Fixed Hardware Style Installation & Operation Manual* (publication 1747-6.21). The processor must be connected to a programming

---

device, properly configured, and must have no rungs in its ladder program. The analog module LED must be illuminated.

**ATTENTION**

The procedure described in this section for testing analog module output channels assumes that all I/O module outputs that normally activate prime movers or other potentially dangerous devices have been disconnected from these devices.

*Do not* attempt to test the analog module output channels unless prime movers and/or other potentially dangerous devices are disconnected from the I/O modules.

---

The devices connected directly to the analog module outputs are referred to as “actuators.” If the actuators do not affect prime movers or initiate any other potentially dangerous operation, use these devices to test the outputs.

If the actuators affect prime movers or initiate a potentially dangerous operation, use a voltmeter to test the voltage outputs and an ammeter to test the current outputs. Note that these meters have some inherent error of their own.

In the latter case, disconnect actuators at the analog module outputs to test the terminal blocks.

The following procedure applies to either of the previous situations.

1. Determine the boundary conditions for the analog module output channel. For example, if the output channel is connected to an actuator that has an input range of 1 volt to 5 volts, the boundary conditions are 1 volt (lower) and 5 volts (upper).
2. Using the formulas from page, calculate the output decimal values that must be entered into the processor image table to produce the analog module output channel boundary conditions determined in step 1.

For example, if 1 volt and 5 volts are boundary conditions, the decimal values would be 3277 and 16384.

3. Create and save the test rung shown below.

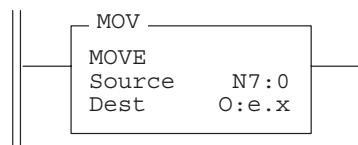

"e" is the slot number of the analog module

"x" is the number of the analog module output channel being tested

4. Download the program to the processor and enter the RUN mode.
5. Display the data in address N7:0.
6. Enter lower boundary condition value in N7:0. For example, if the lower boundary condition is 1 volt, enter 3277 into N7:0.
7. If the output channel has not been disconnected from its actuator, the actuator should assume its lower boundary condition.

If the output channel has been disconnected from its actuator, connect either the ammeter (current output) or voltmeter (voltage output) to the analog module output channel. The exact value of the meter reading is affected by the accuracy of the analog module and the meter. Ensure that the deviation from the lower boundary condition is within tolerances for the application in which the analog module is used.

For example, if 1 volt was the lower boundary condition, the voltmeter should read approximately 1 volt.

8. Enter upper boundary condition value in N7:0. For example, if the upper boundary condition is 5 volts, enter 16384 into N7:0.
9. Repeat step 7 for the upper boundary condition.
10. Repeat steps 1 through 9 for each output channel.
11. If any of the output channels do not pass the start-up procedure, check for the following potential causes:
  - The processor is not in the RUN mode.
  - The terminal block is not secured in the analog module.
  - The analog module terminal block is not wired properly or wires are broken. See chapter 3 for details on wiring the analog module.
  - The actuator or test ammeter/voltmeter is not operating properly.

---

## Programming Examples

This chapter shows several programming examples that provide additional capabilities such as:

- Addressing, Out-of-Range Detection, and Scaling of Analog Inputs
- Addressing and Scaling of Analog Outputs
- Scaling Offsets when  $> 32,767$  or  $< -32,768$
- Scaling and Range Checking of Analog Inputs and Outputs

---

**IMPORTANT**

The programming examples in this chapter are for informational purposes only. Because of the many variables and requirements associated with any application, the Allen–Bradley Company cannot assume responsibility or liability for actual use based on these examples.

---

The following example uses an NI4 analog input module to show input addressing, range checking and scaling of analog inputs into engineering units.

### Addressing, Out-of-Range Detection, and Scaling of Analog Inputs

The following assumptions are being made:

- The NI4 is located in slot 3 of a modular system.
- A temperature transducer with a 0 to 10V dc output is wired to the second input channel on the analog module.
- The transducer voltage signal is proportional to a range of 100° C to 500° C (212° F to 932° F).
- The process temperature must stay between 275° and 300° C (527° F to 572° F). If the temperature deviates from this range, a flag is set and this out-of-range value is not processed. The data is presented in degrees C for monitoring and display purposes.

The scaling operation is displayed in the following graph. It displays the linear relationship between the input and the resulting scaled values.

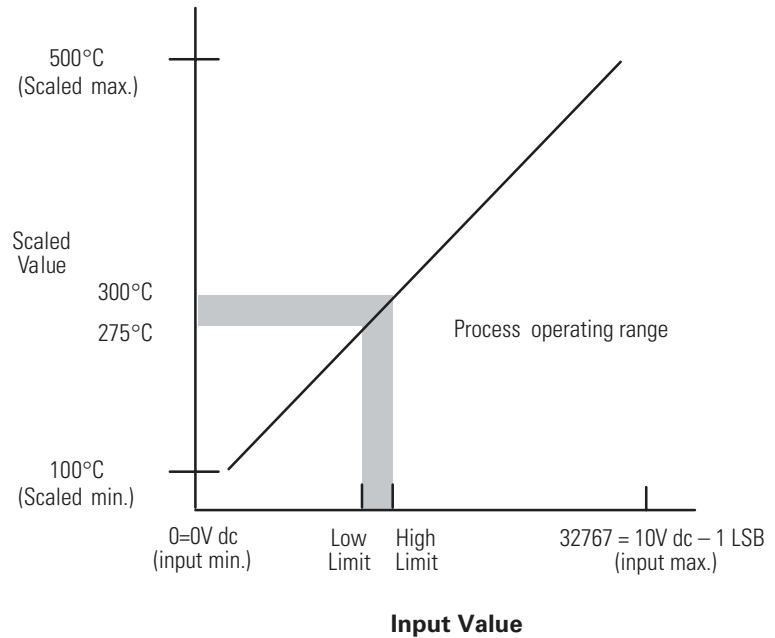

## Calculating the Linear Relationship

Use the following equations to express the linear relationship between the input value and the resulting scaled value.

$$\text{Scaled value} = (\text{input value} \times \text{slope}) + \text{offset}$$

$$\text{Slope} = (\text{scaled max.} - \text{scaled min.}) / (\text{input max.} - \text{input min.})$$

$$(500 - 100) / (32,767 - 0) = 400/32,767$$

$$\text{Offset} = \text{scaled min.} - (\text{input min.} \times \text{slope})$$

$$100 - (0 \times (400/32,767)) = 100$$

$$\text{Scaled value} = (\text{input value} \times (400 / 32767)) + 100$$



## Calculating the Out-of-Range Flag Using the Scale Instruction

Use the following equation to calculate the low and high limit input values which determine the out-of-range flag.

$$\text{Input value} = (\text{scaled value} - \text{offset}) / \text{slope}$$

$$\text{low limit } (275 - 100) / (400/32,767) = 14,344$$

$$\text{high limit } (300 - 100) / (400/32,767) = 16,393$$

Once you have calculated the linear relationship and the out-of-range flag value, this example allows you to:

- Turn on a heater or fan to maintain the process temperature between 275° and 300° C by using the out-of-range flags.
- Monitor the process temperature using a Data Table Access Module (DTAM) or Hand-Held Terminal (HHT).
- *Output* the process temperature for operation interface purposes by:
  - MOVing the scaled value to an output module as variable data to a Dataliner
  - Converting the scaled value to BCD (using TOD instruction) and MOVing it to an LED display

The following ladder diagrams show how to program the processor. The first example uses standard math instructions available in any SLC 500 processor. The ladder diagram prevents a processor fault by unlatching the mathematical overflow bit S2:5/0 before the end of the scan.

The second example uses the scaling instruction (SCL)<sup>®</sup> available in the 5/02 and higher processors. The rate parameter is calculated by multiplying the slope by 10,000.

$$\text{rate} = (400/32767) \times 10,000 = 122$$

If the result of the Source times the Rate, divided by 10000 is greater than 32767, the SCL instruction overflows, causing error 0020 (Minor Error Bit), and places 32767 in the Destination. This occurs regardless of the current offset.

The third example uses the SCP (scale with parameters) instruction available in the SLC 5/03 (OS302 or later), SLC 5/04 (OS401 or later), and SLC 5/05 only.

## Using Standard Math

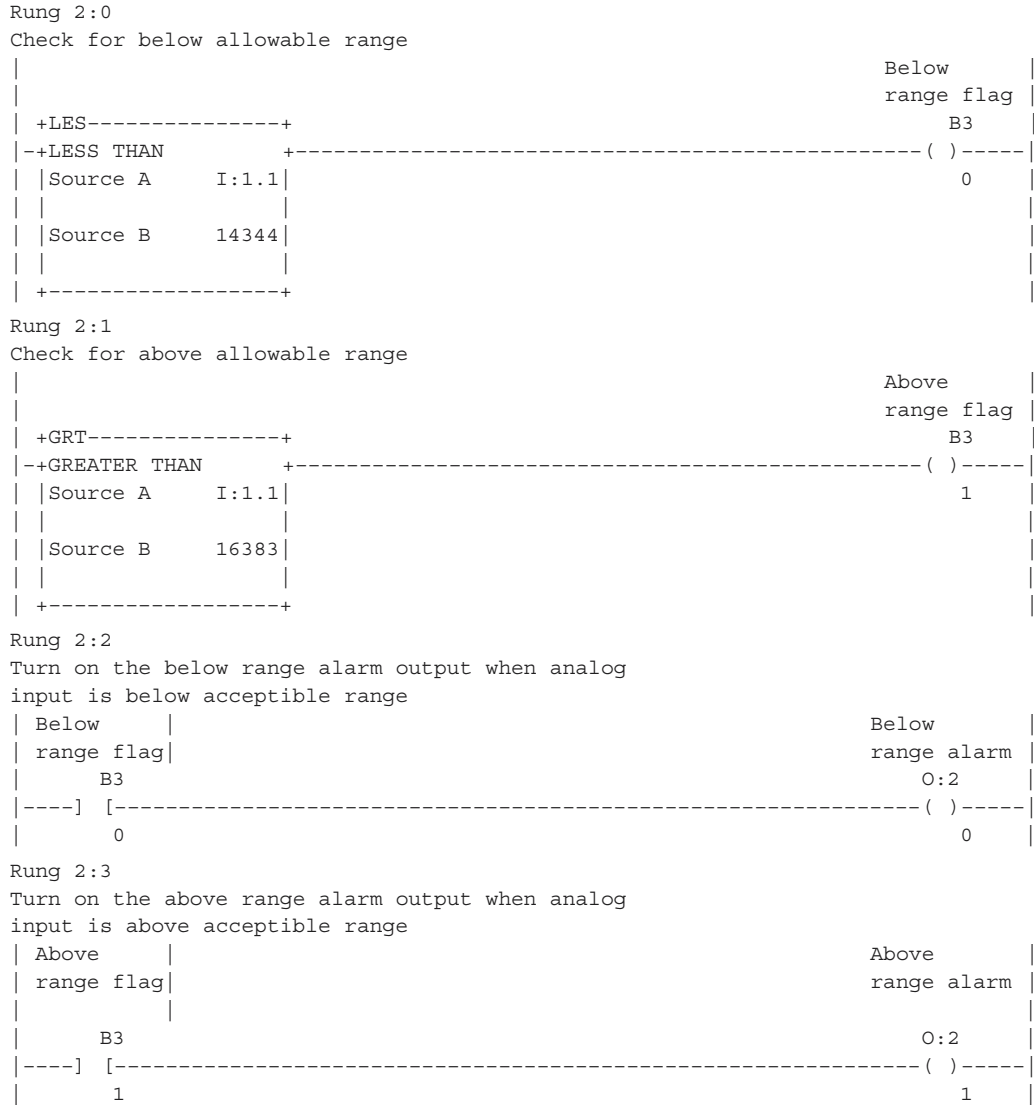

*Ladder logic continued on the next page.*

Rung 2:4

Scale the analog input value and process the result only when it is within the acceptable range

Below Above  
range flag range flag

Multiply  
by the  
scaled range

```

      B3      B3
----] / [-----] / [-----]
      0      1

+-----+
+MULTIPLY+
+-----+
| Source A  I:1.1 |
+-----+
| Source B    400 |
+-----+
| Dest       N7:0 |
|              0 |
+-----+

      Divide
      result by
      input
      range

+DDV-----+
+-----+
+DOUBLE DIVIDE+
+-----+
| Source     32767 |
+-----+
| Dest       N7:0 |
|              0 |
+-----+

      Add offset
      (N7:0 contains
      process
      temperature)

+ADD-----+
+-----+
+ADD+
+-----+
| Source A    N7:0 |
|              0 |
| Source B    100 |
+-----+
| Dest       N7:0 |
|              0 |
+-----+

      Clear flt
      bit from
      overflow
      S:5
+----- (U) -----+
      0
  
```

Rung 2:5

```

-----+END+-----
  
```



## Using Scale with Parameters (SCP) Instruction

```

Rung 2:0
Check for below allowable range.
|
|                                     Below
|                                     range flag
| +LES-----+                                     B3
| -+LESS THAN +----- ( )-----+
| |Source A      I:1.1|
| |               0|
| |Source B      14344|
| |               |
| +-----+
|
|                                     Above
|                                     range flag
| +GRT-----+                                     B3
| -+GREATER THAN +----- ( )-----+
| |Source A      I:1.1|
| |               0|
| |Source B      16383|
| |               |
| +-----+
|
Rung 2:2
Turn on the below range alarm output when the analog
input is below the acceptable range.
| Below
| range flag                                     Below
|      B3                                     range alarm
|-----] [-----] [-----] [-----] ( )-----+
|      0                                     0:2
|                                     0
|
Rung 2:3
Turn on the above range alarm output when the analog
input is above the acceptable range.
| Above
| range flag                                     Above
|      B3                                     range alarm
|-----] [-----] [-----] [-----] ( )-----+
|      1                                     0:2
|                                     1
|
Rung 2:4
| Below      |Above
| range flag |range flag
|      B3      B3
|-----]/[-----]/[-----] [-----] +SCP-----+
|                                     +SCALE W/PARAMETERS+
|                                     |Input      I:1.1|
|                                     |           0|
|                                     |Input Min.  0|
|                                     |           |
|                                     |Input Max.  32767|
|                                     |           |
|                                     |Scaled Min.  100|
|                                     |Scaled Max.  500|
|                                     |           |
|                                     |Scaled Output N7:0|
|                                     |           0|
|                                     +-----+
|
Rung 2:5
|
|-----+-----+-----+-----+-----+-----+-----+-----+
+END+

```

## Addressing and Scaling Outputs

We are making the following assumptions:

- The NIO4I is located in slot 2 of a SLC 500 system.
- An actuator from a flow control valve is wired to output channel 0.
- The actuator accepts a 4 mA to 20 mA signal proportional to 0 to 100% of the valve's opening. For this example the signal actuator can not receive a signal out of the 4 mA to 20 mA range.
- The percentage of valve opening is manually input to the SLC.

The following graph displays the linear relationship.

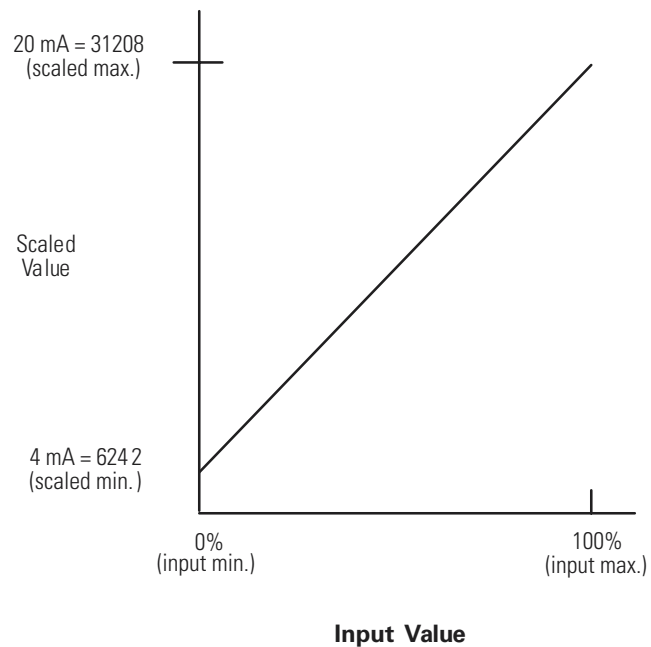

### Calculating the Linear Relationship

Use the following equations to calculate the scaled output value:

$$\text{Scaled value} = (\text{input value} \times \text{slope}) + \text{offset}$$

$$\text{Slope} = (\text{scaled max.} - \text{scaled min.}) / (\text{input max.} - \text{input min.})$$

$$(31,208 - 6,242) / (100-0) = 24,966/100$$

$$\text{Offset} = \text{scaled min.} - (\text{input min.} \times \text{slope})$$

$$6,242 - (0 \times (24,966/100)) = 6,242$$

$$\text{Scaled value} = (\text{input value} \times (24,966/100)) + 6,242$$

The out-of-range limits are predetermined because any value less than 0% is 6,242 and any value greater than 100% is 31,208. The ladder logic checks for the out-of-range flag to verify that not less than 4 mA and not more than 20 mA is provided out of the analog output channel.

The percentage of valve opening may be *input* to the processor by:

- entering the data through a DTAM or HHT
- MOVing the data from thumb wheels or a keypad (possibly converting the data from BCD using FRD instruction)

The percentage of valve opening may be *output* for operator interface by:

- monitoring the data using a DTAM or HHT
- MOVing the data to an output module as variable data to a Dataliner
- converting the data to BCD (using TOD instruction) and MOVing it to an LED display

Since the slope is greater than 3.2767 only standard math can be used for the ladder diagram with SLC 500 fixed, SLC 5/01, 5/02, 5/03 (OS300 or OS301), and 5/04 (OS400) processors. The ladder diagram prevents a processor fault by unlatching the mathematical overflow bit S2:5/0 before the end of the scan. Refer to the example ladder diagram on the next page. Following the standard math example is a ladder diagram using the SCP instruction, available only in the SLC 5/03 (OS302 or later), SLC 5/04 (OS401 or later), and SLC 5/05.

## Using Standard Math

Rung 2:0

N7:0 contains percentage of valve open. If this value is less than 0, move the minimum value to the analog output (6242 decimal = 4 mA at the analog output).

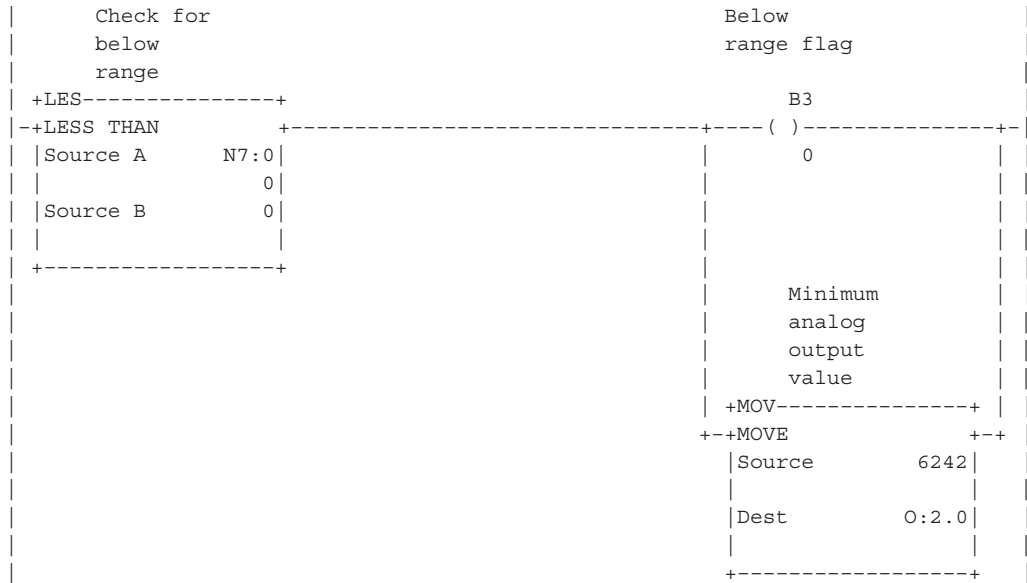

Rung 2:1

N7:0 contains percentage of valve open. If this value is greater than 100, move the maximum value to the analog output (31208 decimal = 20 mA at the analog output).

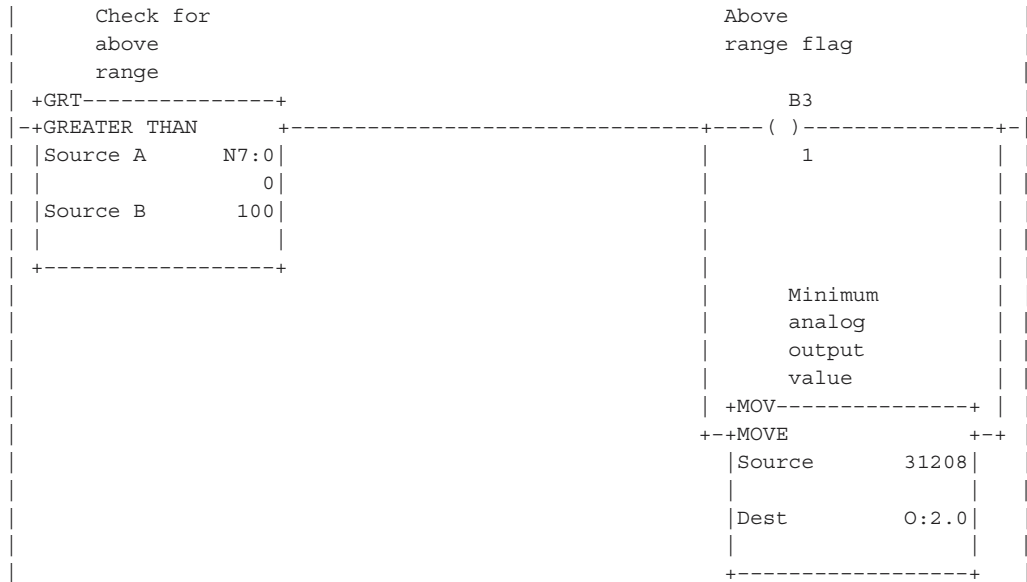

*Ladder logic continued on the next page.*









## Scaling Offset when > 32,767 or < -32,768

There may be applications when the offset value put into standard math instructions is greater than 32,767 or less than -32,768. In these cases, it is easier to shift the linear relationship along the input value axis and reduce the values.

This example is similar to the situation described in Example 2, except the 4 mA to 20 mA signal is scaled to a value between 90-100%. The NIO4I is located in slot 2 and the output device is wired to channel 0.

The following graph displays the linear relationship.

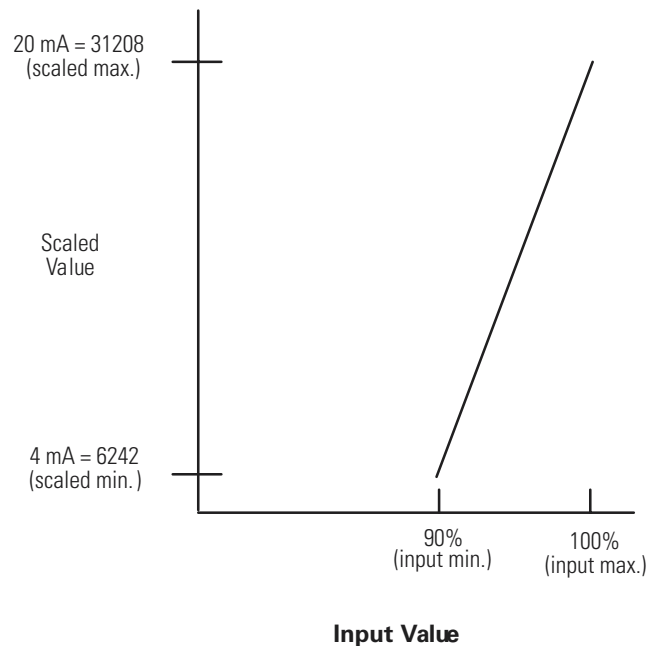

## Calculating the Linear Relationship

Use the following equations to calculate the scaled units:

$$\text{Scaled value} = (\text{input value} \times \text{slope}) + \text{offset}$$

$$\text{Slope} = (\text{scaled max.} - \text{scaled min.}) / (\text{input max.} - \text{input min.})$$

$$(31,208 - 6,242) / (100 - 90) = 24,966/10$$

$$\text{Offset} = \text{scaled min.} - (\text{input min.} \times \text{slope})$$

$$6242 - (90 \times (24,966/10)) = -218,452$$

$$\text{Scaled value} = (\text{input value}) \times (24,966/10) - 218,452$$

Notice the offset value is less than -32,768.

The following graph shows the shifted linear relationship. Notice that the resulting offset value is reduced.

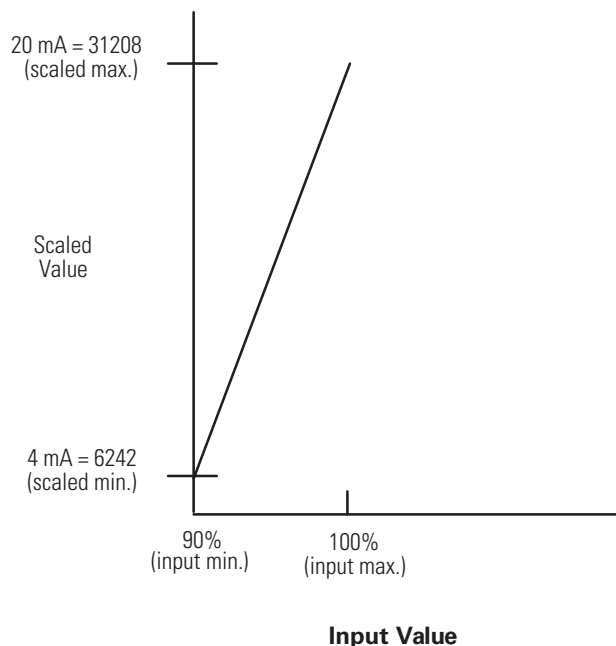

## Calculating the Shifted Linear Relationship

Use the following equations to recalculate the linear relationship:

$$\text{Scaled value} = ((\text{input value} - \text{input min.}) \times \text{slope}) + \text{offset}$$

$$\text{Slope} = (\text{scaled max.} - \text{scaled min.}) / (\text{input max.} - \text{input min.})$$

$$(31,208 - 6,242) / (100 - 90) = 24,966/10$$

$$\text{Offset} = \text{scaled min.}$$

$$6,242$$

$$\text{Scaled value} = ((\text{input value} - 90) \times (24,966/10)) + 6242$$

Since the slope is greater than 3.2767, only standard math can be used for the ladder diagram with SLC 500 fixed, SLC 5/01, 5/02, 5/03 (OS300 and 301) and 5/04 (OS400). The following ladder diagram prevents a processor fault by unlatching the mathematical overflow bit S2:5/0 before the end of the scan. Refer to the example ladder diagram on the next page. Following this example is another ladder diagram performing the same function, but using the SCP (scale with parameters) instruction available only in the SLC 5/03 (OS302), SLC 5/04 (OS401), and SLC 5/05.





## Using the Scale with Parameters (SCP) Instruction

Rung 2:0

N7:0 contains percentage of valve open. If this value is less than 90, move the minimum value to the analog output (6242 decimal = 4 mA at the analog output).

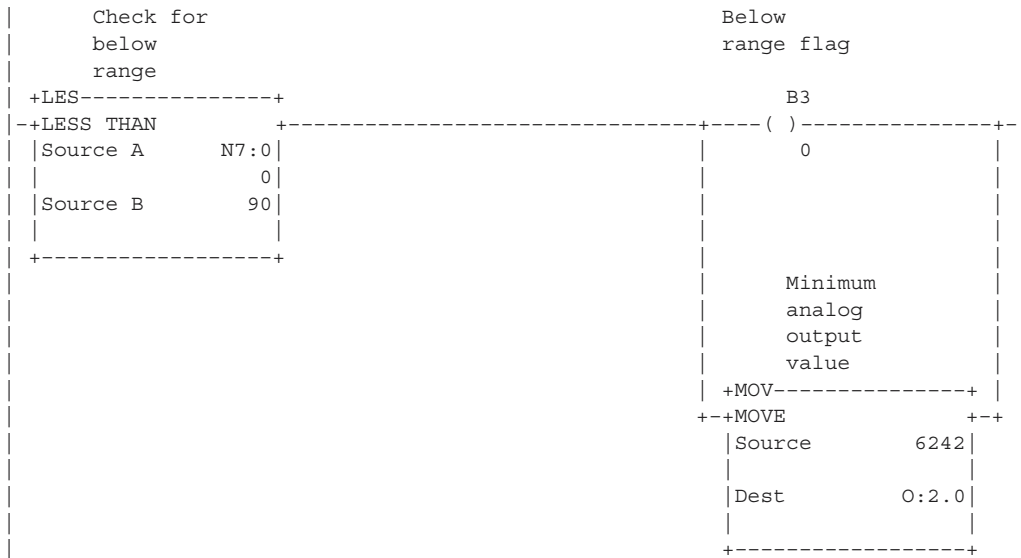

Rung 2:1

N7:0 contains percentage of valve open. If this value is greater than 100, move the maximum value to the analog output (31208 decimal = 20 mA at the analog output).

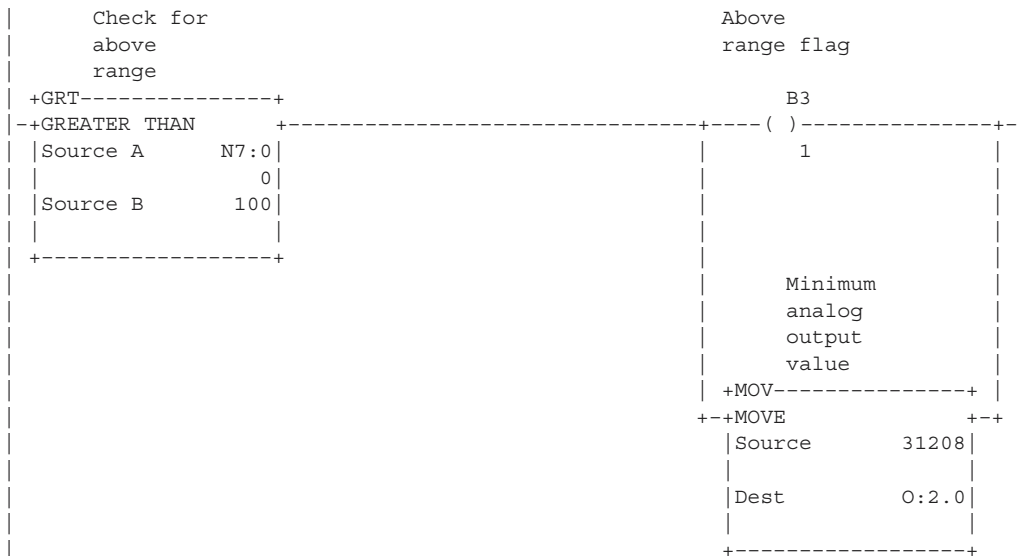

*Ladder logic continued on the next page.*



Rung 2:2  
 Scale values in the 90 to 100% range to the  
 decimal range for the 4-20 mA analog output.

Below	Above	Scale for the analog output
range flag	range flag	
B3	B3	+SCP-----+
-----]	-----]	+SCALE W/PARAMETERS +--
0	1	Input N7:0
		Input Min. 90
		Input Max. 100
		Scaled Min. 6242
		Scaled Max. 31208
		Scaled Output 0:2.0
		+-----+

Rung 2:3

-----+END+-----

## Scaling and Range Checking and Analog Inputs and Outputs

This example demonstrates the addressing of analog I/O and the scaling and range checking of analog input and output values. An NIO4V is placed in slot 1 of an SLC 500 system. A 0 to 200 psi pressure sensor is input as a 4 mA to 20 mA signal to input channel 0. The input value is checked to ensure it remains within the 4 mA to 20 mA range.

It is then scaled and output as a 0 to 2.5 volt signal to a panel meter pressure display connected to output channel 0. If an out-of-range condition is detected a flag bit will be set. The scaling operation is shown below.

The graph displays the linear relationship between the input value and the resulting scaled value.

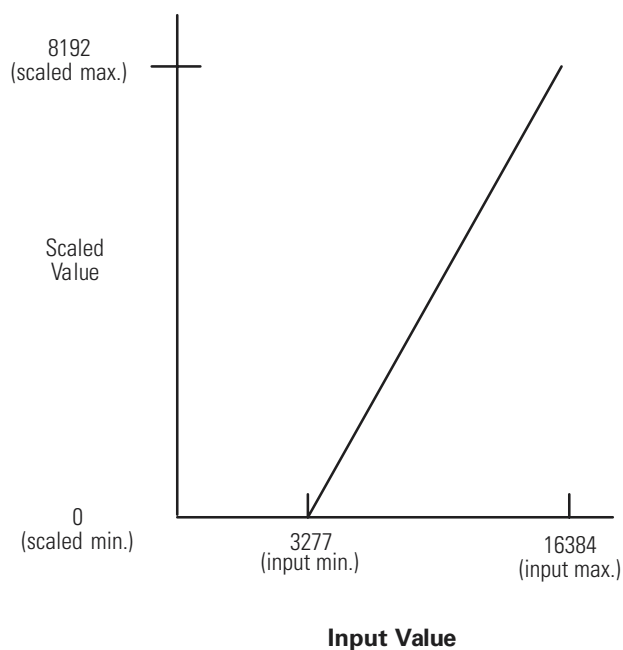

## Calculating the Linear Relationship

Use the following equations to express the linear relationship between the input value and the resulting scaled value:

$$\text{Scaled value} = (\text{input value} \times \text{slope}) + \text{offset}$$

$$\text{Slope} = (\text{scaled max.} - \text{scaled min.}) / (\text{input max.} - \text{input min.})$$

$$(8192 - 0) / (16384 - 3277) = 8192/13107$$

$$\text{Offset} = \text{scaled min.} - (\text{input min.} \times \text{slope})$$

$$0 - 3277 (8192/13,107) = -2048$$

$$\text{Scaled value} = (\text{input value} \times (8192/13017)) - 2048$$

This equation can be implemented using integer math capabilities of the SLC 500 system. Three example programs are shown. The first runs on any SLC 500 processor and the second uses the scaling instruction available on the SLC 5/02 and later processors. The third program uses the SCP (scale with parameters) instruction available only with SLC 5/03 (OS302 or later), SLC 5/04 (OS401 or later), and SLC 5/05.

In the first example program the analog input value is checked against the minimum and maximum allowable input values.

If the input is out-of-range, the output value is set to its minimum or maximum value. If the input value is in range the output value is determined by scaling the input. To scale an analog input, follow these steps:

1. Multiply the input by the scaled range  
Scale range=(scaled max. - scaled min.).
2. Divide the 32 bit result by the input range  
Input range=(input max. - input min.).
3. Add in the offset value (in this case negative). The final value is then moved to the analog output channel 0.

The multiply operation will generate an overflow bit and minor error flag whenever the results exceed 16 bits. Since the divide is carried out on the 32 bit result in the math register, the overflow does not present a problem. The minor error flag has to be cleared before the end of the program scan to avoid a system error.



Rung 2:1

Check for above range.

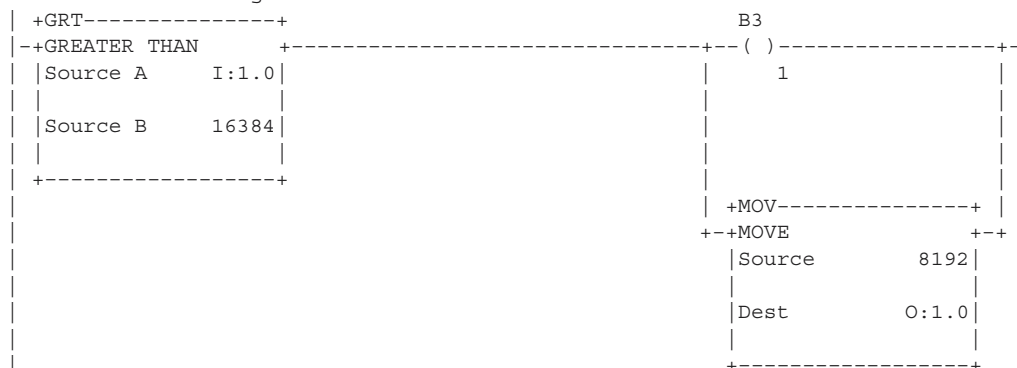

Rung 2:2

Scale the analog input for the analog output.

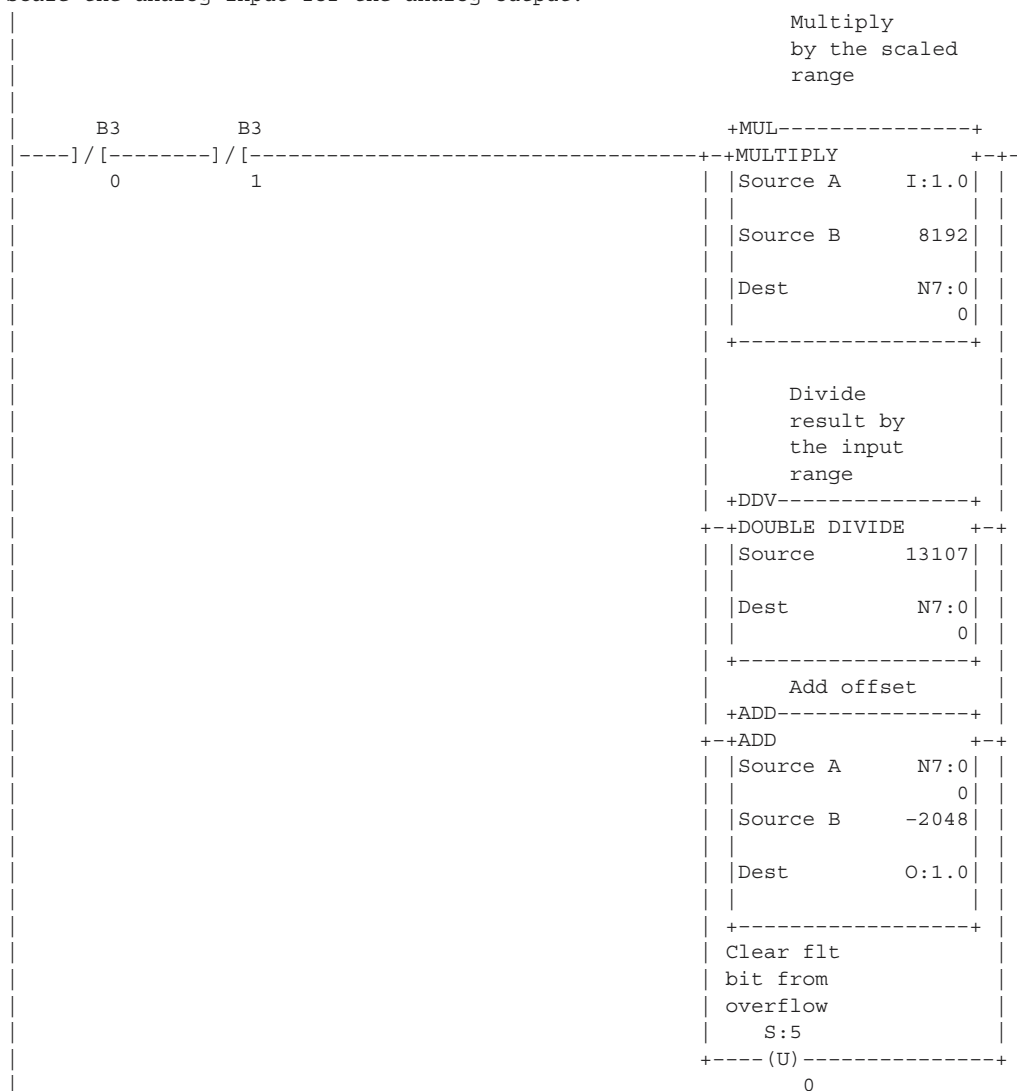

Rung 2:3

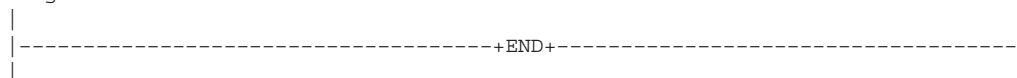

## **Scaling and Range Checking of Analog Inputs and Outputs**

The scaling instruction available in the SLC 5/02 processor is used to realize a more efficient program. The scaling instruction uses the same multiply, divide and add algorithm but it does so with a single rate instead of the scaled range and input range values. The rate is determined by:

$$\text{Rate} = (\text{scaled range} / \text{input range}) \times 10,000$$

For the programming example the rate = 6250







---

## Maintenance and Safety

### Preventative Maintenance

This chapter provides preventive maintenance information and safety considerations when troubleshooting your SLC 500 system.

The printed circuit boards of the analog modules must be protected from dirt, oil, moisture and other airborne contaminants. To protect these boards, the SLC 500 system must be installed in an enclosure suitable for the environment. The interior of the enclosure should be kept clean and the enclosure door should be kept closed whenever possible.

Regularly inspect your terminal connections for tightness. Loose connections may cause improper functioning of the SLC 500 system or damage the components of the system.

---

**ATTENTION**

To ensure personal safety and to guard against equipment damage, inspect connections with incoming power OFF.

---

For general maintenance procedures for electrical equipment, refer to the requirements specific to your region.

- *Europe*: Refer to the standards found in EN 60204 and your national regulations.
- *United States*: Refer to article 70B of the National Fire Protection Association (NFPA). It describes general requirements regarding safety related work practices.

Safety considerations are an important element of proper troubleshooting procedures. Actively thinking about the safety of yourself and others, as well as the condition of your equipment, is of primary importance. Refer to the *SLC 500 Fixed Hardware Style Installation & Operation Manual* (publication 1747-6.21) or the *SLC 500 Modular Hardware Style User Manual* (publication 1747-UM011) for additional information on troubleshooting.

## Safety Considerations When Troubleshooting

The following section describes several safety areas you should be aware of when troubleshooting your SLC 500 system.

**Indicator Lights** - When the red LED on the analog module is illuminated it indicates that 24V dc power is applied to the module.

**Activating Devices When Troubleshooting** - When troubleshooting, never reach into the machine to actuate a device. Unexpected machine motion could occur. Use a wooden stick.

**Stand Clear of Machine** - When troubleshooting any SLC 500 system problem, have all personnel remain clear of the machine. The problem could be intermittent, and sudden unexpected machine motion could occur. Have someone ready to operate an emergency stop switch in case it becomes necessary to shut off power to the machine.

---

**ATTENTION**

Never reach into a machine to actuate a switch since unexpected machine motion can occur.

Remove all electrical power at the main power disconnect switches before checking electrical connections or inputs/outputs causing machine motion.

---

**Program Alteration** - There are several causes of alteration to the user program, including extreme environmental conditions, Electromagnetic Interference (EMI), improper grounding, improper wiring connections, and unauthorized tampering. If you suspect the program has been altered, check it against a previously saved program on an EEPROM or UVROM memory module.

**Safety Circuits** installed on the machine for safety reasons, like over travel limit switches, stop push buttons, and interlocks, should always be hard-wired to the master control relay. These devices must be wired in series so that when any one device opens, the master control relay is de-energized thereby removing power to the machine. Never alter these circuits to defeat their function. Serious injury or machine damage could result.



## Specifications

### Analog Modules Specification

This section lists the specifications for the 1746-NI4, NIO4I, NIO4V, NO4I and NO4V analog modules. They include:

- General specifications
- Current and Voltage input specifications
- Current and Voltage output specifications

### General Specifications for NI4, NIO4I, NIO4V, NO4I, and NO4V

Specification	Value
SLC Communication Format	16 Bit Two's Complement Binary
Field Wiring to Backplane Isolation	500V dc
Update Time	512 $\mu$ s for all channels in parallel
Recommended Cable	Shielded Belden #8761
Maximum Wire Size	#14 AWG (maximum)
Terminal Block	Removable
Location	1746 chassis
Calibration	Factory Calibrated (Refer to calibration procedure, pg. D-2)
Noise Immunity	NEMA Standard ICS 2-230
Environmental Conditions Operating Temperature Storage Temperature Relative Humidity	0° to +60° C (+32° to +140° F) -40° to +85° C (-40° to +185° F) 5 to 95% (non-condensing)
Agency Certification (when product or packaging is marked)	 C-UL Listed Industrial Control Equipment for use in Class 1, Div 2 Hazardous Locations  Marked for all applicable directives  Marked for all applicable acts <small>N223</small>

## General Analog Input

Catalog 1746-	Input Channels per Module	Output Channels per Module	Backplane Current Draw		External 24V dc Power Supply Tolerance
			5V (max.)	24V (max.)	
NI4	4 differential, voltage or current selectable per channel, not individually isolated	NA	35 mA	85 mA	NA
NIO4I	2 differential, voltage or current selectable per channel, not individually isolated	2 current outputs, not individually isolated	55 mA	145 mA	NA
NIO4V	2 differential, voltage or current selectable per channel, not individually isolated	2 voltage outputs, not individually isolated	55 mA	115 mA	NA
NO4I	NA	4 current outputs, not individually isolated	55 mA	195 mA	24 ±10% at 195 mA max. (21.6 to 26.4V dc) <sup>(1)</sup>
NO4V	NA	4 voltage outputs, not individually isolated	55 mA	145 mA	24 ±10% at 145 mA max. (21.6 to 26.4V dc) <sup>(1)</sup>

(1) Required for some applications if SLC 24V power is not readily available.

## Specifications for NI4, NIO4I, and NIO4V

Specification	1746-NI4	1746-NIO4I, -NIO4V
Converter Resolution	16 bit	
Repeatability	±1 LSB	
Location of LSB in I/O image word	0000 0000 0000 0001	
Non-linearity	0.01 %	
Common Mode Voltage Range	-20 to +20 volts	
Common Mode Rejection at 0 to 10 Hz (min.)	50 dB	
Common Mode Rejection at 60 Hz (min.)	105 dB	
Normal Mode Rejection at 60 Hz (min.)	55 dB	
Channel Bandwidth	10 Hz	
Step Response	60 ms at 95%	
Conversion Method	Delta-Sigma Modulation	
Impedance to ANL COM	380K ohms <sup>(1)</sup>	500K ohms
Impedance channel to channel	760K ohms <sup>(2)</sup>	1M ohms

(1) The value listed is for Series B and greater. For Series A, the impedance to ANL COM is 500K Ohms.

(2) The value listed is for Series B and greater. For Series A, the impedance channel to channel is 500K Ohms.

## Current-Loop Input Specifications for NI4, NI04I, and NI04V

Specification	1746-NI4, -NI04I, -NI04V
Input Range (Normal Operation)	-20 to +20 mA
Absolute Maximum Input Current	-30 to +30 mA
Absolute Maximum Input Voltage	±7.5V dc or 7.5V ac RMS
Current Input Coding -20 to +20 mA	-16,384 to +16,384
Input Impedance	250 Ohms
Resolution	1.22070 µA per LSB
Full Scale	20 mA
Overall Accuracy at +25° C (77° F) (max.)	±0.365% of full scale
Overall Accuracy at 0° to +60° C (32° to 140° F) (max.)	±0.642% of full scale <sup>(1)</sup>
Overall Accuracy Drift (max.)	+79 ppm/5 C of full scale
Gain Error at +25° C (77° F) (max.)	+0.323%
Gain Error at 0° to +60° C (32° to 140° F) (max.)	±0.556%
Gain Error Drift (max.)	±67ppm/° C
Offset Error at +25° C (77° F) (max.) (Iin = 0, Vcm = 0)	±7 LSB
Offset Error at 0° to +60° C (32° to 140° F) (max.) (Iin = 0, Vcm = 0)	±14 LSB
Offset Error Drift (max.) (Iin = 0, Vcm = 0)	±0.20 LSB/° C

(1) Refer to Appendix C for a method to improve accuracy over temperature.

## Voltage Input Specifications for NI4, NI04I, and NI04V

Specification	1746-NI4	1746-NI04I, -NI04V
Input Range	-10 to +10V dc - 1 LSB	
Voltage Input Coding (-10 to +10V dc - 1 LSB)	-32,768 to +32,767	
Input Impedance	760K ohms <sup>(1)</sup>	1M ohms
Resolution	305.176 $\mu$ V per LSB	
Full Scale	10V dc	
Overall Accuracy at +25° C (77° F) (max.)	$\pm$ 0.284% of full scale	
Overall Accuracy at 0° to +60° C (32° to 140° F) (max.)	$\pm$ 0.504% of full scale <sup>(2)</sup>	
Overall Accuracy Drift (max.)	$\pm$ 63 ppm/° C of full scale	
Gain Error at +25° C (77° F) (max.)	$\pm$ 0.263%	
Gain Error at 0° to +60° C (32° to 140° F) (max.)	$\pm$ 0.461%	
Gain Error Drift (max.)	$\pm$ 57 ppm/° C	
Offset Error at +25° C (77° F) (max.)	$\pm$ 7 LSB	
Offset Error at 0° to +60° C (32° to 140° F) (max.)	$\pm$ 14 LSB	
Offset Error Drift (max.)	$\pm$ 0.20 LSB/° C	
Overvoltage Protection (max. across IN+ to IN- terminals)	either 220V ac RMS continuously or 220V dc continuously	

(1) The value listed is for Series B and greater. For Series A, the input impedance is 1M ohm.

(2) Refer to Appendix C for a method to improve accuracy over temperature.

## Current Output Specifications for NI04I and N04I

Specification	1746-NI04I, -N04I
Converter Resolution	14 bit
Location of LSB in I/O image word	0000 0000 0000 01XX
Non-linearity	0.05%
Conversion Method	R-2R Ladder
Step Response	2.5 ms (at 95%)
Load Range	0 to 500 Ohms
Maximum Load Reactance	100 $\mu$ H
Current Output Coding (0 to +21 mA - 1 LSB)	0 to +32764
Output Range (Normal)	0 to +20 mA
Ovrange Capability	5% (0 to +21 mA - 1 LSB)
Resolution	2.56348 $\mu$ A per LSB
Full Scale	21 mA
Overall Accuracy at +25° C (77° F) (max.)	$\pm$ 0.298% of full scale
Overall Accuracy at 0° to +60° C (32° to 140° F) (max.)	$\pm$ 0.541% of full scale
Overall Accuracy Drift (max.)	$\pm$ 70 ppm/° C of full scale
Gain Error at +25° C (77° F) (max.)	$\pm$ 0.298%
Gain Error at 0° to +60° C (32° to 140° F) (max.)	$\pm$ 0.516%
Gain Error Drift (max.)	$\pm$ 62 ppm/° C
Offset Error at +25° C (77° F) (max.)	$\pm$ 10 LSB
Offset Error at 0° to +60° C (32° to 140° F) (max.)	$\pm$ 12 LSB
Offset Error Drift (max.)	$\pm$ 0.06 LSB/° C

## Voltage Output Specifications for NI04V and N04V

Specification	1746--NI04V, -N04V
Converter Resolution	14 bit
Location of LSB in I/O image word	0000 0000 0000 01XX
Non-linearity	0.05%
Conversion Method	R-2R Ladder
Step Response	2.5 ms (at 95%)
Load Range	1K to $\infty$ Ohms
Maximum Load Current	10 mA
Maximum Load Reactance	1 $\mu$ F
Voltage Output Coding (-10 to +10V dc - 1 LSB)	-32,768 to +32,764
Output Range (Normal)	-10 to +10 volts - 1 LSB
Resolution	1.22070 mV per LSB
Full Scale	10V dc
Overall Accuracy at +25° C (77° F) (max.)	$\pm$ 0.208% of full scale
Overall Accuracy at 0° to +60° C (32° to 140° F) (max.)	$\pm$ 0.384% of full scale
Overall Accuracy Drift (max.)	$\pm$ 54 ppm/° C of full scale
Gain Error at +25° C (77° F) (max.)	$\pm$ 0.208%
Gain Error at 0° to +60° C (32° to 140° F) (max.)	$\pm$ 0.374%
Gain Error Drift (max.)	$\pm$ 47 ppm/° C
Offset Error at +25° C (77° F) (max.)	$\pm$ 9 LSB
Offset Error at 0° to +60° C (32° to 140° F) (max.)	$\pm$ 11 LSB
Offset Error Drift (max.)	$\pm$ 0.05 LSB/° C



## Two's Complement Binary Numbers

The SLC 500 processor memory stores 16-bit binary numbers. Two's complement binary is used when performing mathematical calculations internal to the processor. Analog input values from the analog modules are returned to the processor in 16-bit two's complement binary format. For positive numbers, the binary notation and two's complement binary notation are identical.

As indicated in the figure on the next page, each position in the number has a decimal value, beginning at the right with  $2^0$  and ending at the left with  $2^{15}$ . Each position can be 0 or 1 in the processor memory. A 0 indicates a value of 0; a 1 indicates the decimal value of the position. The equivalent decimal value of the binary number is the sum of the position values.

### Positive Decimal Values

The far left position is always 0 for positive values. As indicated in the figure on the next page, this limits the maximum positive decimal value to 32767 (all positions are 1 except the far left position). For example:

$$\begin{aligned} 0000\ 1001\ 0000\ 1110 &= 2^{11} + 2^8 + 2^3 + 2^2 + 2^1 \\ &= 2048 + 256 + 8 + 4 + 2 = 2318 \end{aligned}$$

$$\begin{aligned} 0010\ 0011\ 0010\ 1000 &= 2^{13} + 2^9 + 2^8 + 2^5 + 2^3 \\ &= 8192 + 512 + 256 + 32 + 8 = 9000 \end{aligned}$$

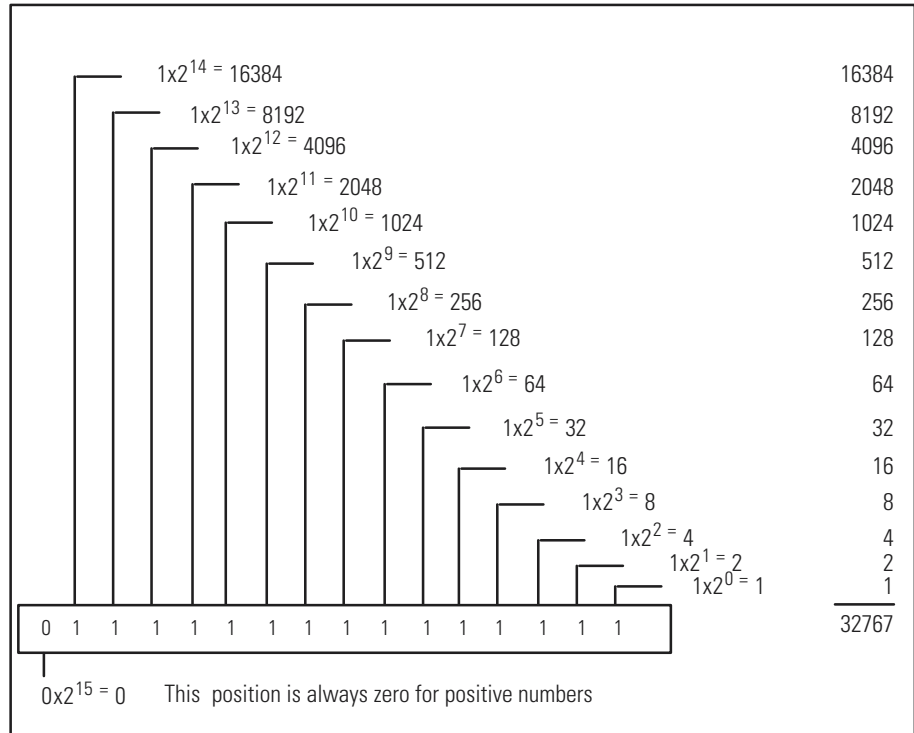

## Negative Decimal Values

In two's complement notation, the far left position is always 1 for negative values. The equivalent decimal value of the binary number is obtained by subtracting the value of the far left position, 32768, from the sum of the values of the other positions. In the figure on the next page (all positions are 1), the value is  $32767 - 32768 = -1$ . For example:

$$1111\ 1000\ 0010\ 0011 =$$

$$(2^{14} + 2^{13} + 2^{12} + 2^{11} + 2^5 + 2^1 + 2^0) - 2^{15} =$$

$$(16384 + 8192 + 4096 + 2048 + 32 + 2 + 1) - 32768 =$$

$$30755 - 32768 = -2013.$$

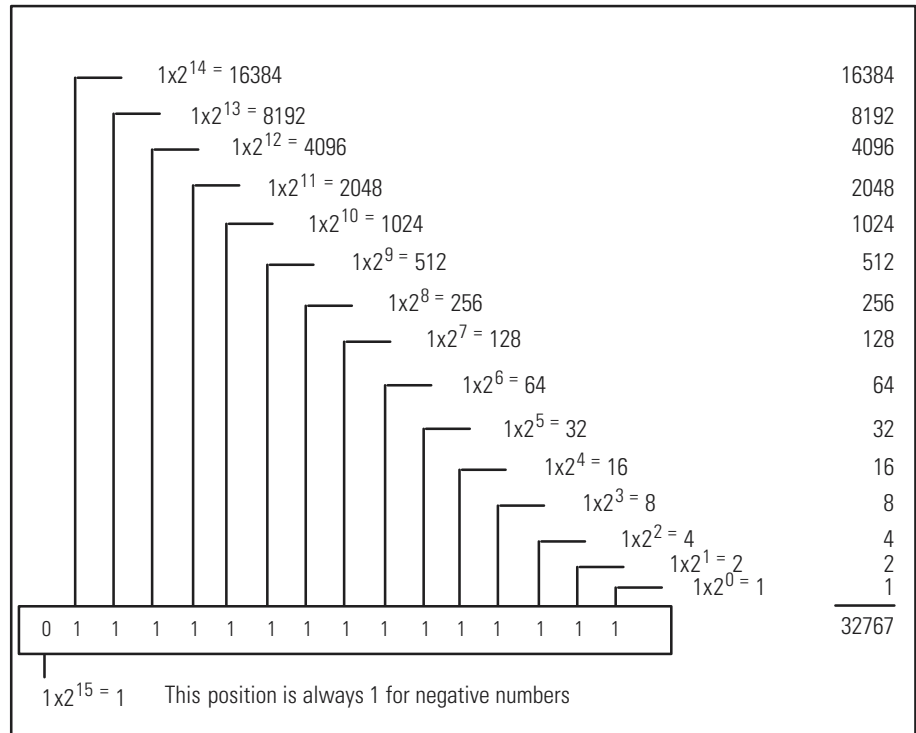



## Optional Analog Input Software Calibration

This appendix helps you calibrate an analog input channel using software offsets to increase the expected accuracy of an analog input circuit. Examples of equations and a ladder diagram are provided for your reference. A software calibration reduces the offset error and gain error at a given temperature by scaling the values read at calibration time.

### Calibrating an Analog Input Channel

The following procedure can be adapted to all analog inputs; current or voltage. For this example the 1746-NI4 with a 4 mA to 20 mA input is used. Refer to the 1746-NI4 specifications in appendix A. These specifications represent the worst case values. The overall error for the NI4, which is guaranteed to be not more than  $\pm 0.365\%$  includes non-linearity, repeatability, offset error and gain error at a given temperature.

The overall error of  $\pm 0.365\%$  at 20 mA equates to  $\pm 60$  LSB of error, or a code range of 16324 to 16444. Any value in this range is returned by an analog input channel at 20 mA. The expected nominal value at 20 mA is 16384. After performing a software calibration the overall error is reduced to 3 LSB, or a code range of 16381 to 16387.

The graph on the next page shows the linear relationship between the input value and the resulting scaled value. The values in this graph are from the example program.

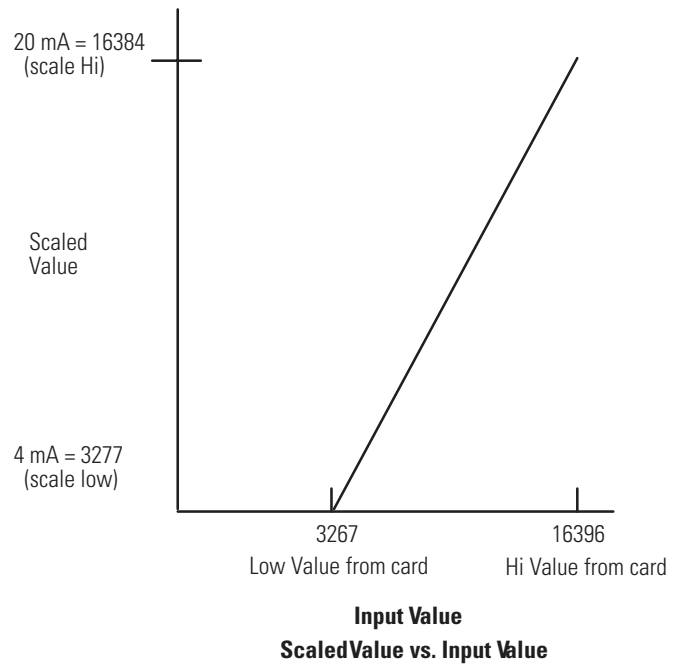

## Calculating the Software Calibration

Use the following equation to perform the software calibration:

**Scaled Value** = (input value x slope) + offset

Slope = (scaled max. - scaled min.) / (input max. - input min.)

Offset = Scaled min. - (input min. x slope)

### Procedure

1. Place your SLC 500 system in the normal operating temperature. Ensure that adjacent I/O modules in your system do not cause temperature fluctuations. For example, place high power and random load I/O modules away from your analog input module.
2. Determine the scaled high and low values you wish to use in your application. In this example, scaled high is 16384 and scaled low is 3277.
3. Using an analog input calibration source or your system's input device placed at the 4 mA position, capture the low value by energizing the calibrate low input. Ensure that your low value lies within the conversion range of your analog input.

4. Using an analog input calibration source or your system's input device placed at the 20 mA position, capture the high value by energizing the calibrate high input. Ensure that your high value lies within the conversion range of your analog input.
5. Energize the calibrate input. This causes the SLC to calculate the slope and offset values used to perform the error correction to the analog input.

The analog channel is now calibrated to  $\pm 3$  LSB at the calibration temperature. Use the offset error drift and gain error drift to calculate the amount of additional error that can be introduced into your system due to temperature variation.

The recommended calibration period is once every 6 months. If an application has a wide range of operating temperatures, a software calibration should be performed every 3 to 4 months.

### Example Ladder Diagram

The following ladder diagram requires 3 external inputs that are used to perform the calibration procedure. Lo causes the ladder to capture the 4 mA calibration value and Hi causes the ladder to capture the 20 mA calibration value. Cal causes the ladder diagram to scale the Hi and Lo values to the nominal values, which provides the slope and offset values used to calibrate the analog input channel.

The following symbols are used in this example:

Cal\_Lo= I:1.0/0  
Cal\_Hi= I:1.0/1  
Calibrate= I:1.0/2  
Conversion= N10:0/3  
Enable  
Analog\_In= I:2.0  
Lo\_Value= N10:1  
Hi\_Value= N10:2  
Scale\_Hi= N10:3  
Scale\_Lo= N10:4  
Scale\_Span= N10:7  
Span= N10:9  
Slope\_x10K= N10:18  
Offset= N10:19  
Analog\_Scl= N10:20



```

Rung 2:0
| Cal_Lo
| I:1      N10:0
|-----] [-----[OSR]-----+MOV-----+
|           0      0
|                                     |Source  ANALOG_IN|
|                                     |           8000|
|                                     |Dest    LO_VALUE|
|                                     |           3267|
|                                     +-----+

Rung 2:1
| Cal_Hi
| I:1      N10:0
|-----] [-----[OSR]-----+MOV-----+
|           1      1
|                                     |Source  ANALOG_IN|
|                                     |           8000|
|                                     |Dest    HI_VALUE|
|                                     |          16396|
|                                     +-----+

Rung 2:2
| Calibrate
| I:1      N10:0
|-----] [-----[OSR]-----+SUB-----+
|           2      2
|                                     |Source A  HI_VALUE|
|                                     |          16396|
|                                     |Source B  LO_VALUE|
|                                     |           3267|
|                                     |Dest      SPAN|
|                                     |          13129|
|                                     +-----+
|                                     +SUB-----+
|                                     +-+SUBTRACT +-----+
|                                     |Source A  SCALE_HI|
|                                     |          16384|
|                                     |Source B  SCALE_LO|
|                                     |           3277|
|                                     |Dest      SCALE_SPAN|
|                                     |          13107|
|                                     +-----+
|                                     +MUL-----+
|                                     +-+MULTIPLY +-----+
|                                     |Source A    SCALE_SPAN|
|                                     |          13107|
|                                     |Source B    10000|
|                                     |Dest        N10:16|
|                                     |          32767|
|                                     +-----+
|                                     +DDV-----+
|                                     +-+DOUBLE DIVIDE +-----+
|                                     |Source      SPAN|
|                                     |          13129|
|                                     |Dest      SLOPE_X10K|
|                                     |           9983|
|                                     +-----+

```

*Ladder logic continued on the next page.*



## Module Input and Output Circuits

### Input Circuit for 1746-NI4, -NI04I, and -NI04V Modules

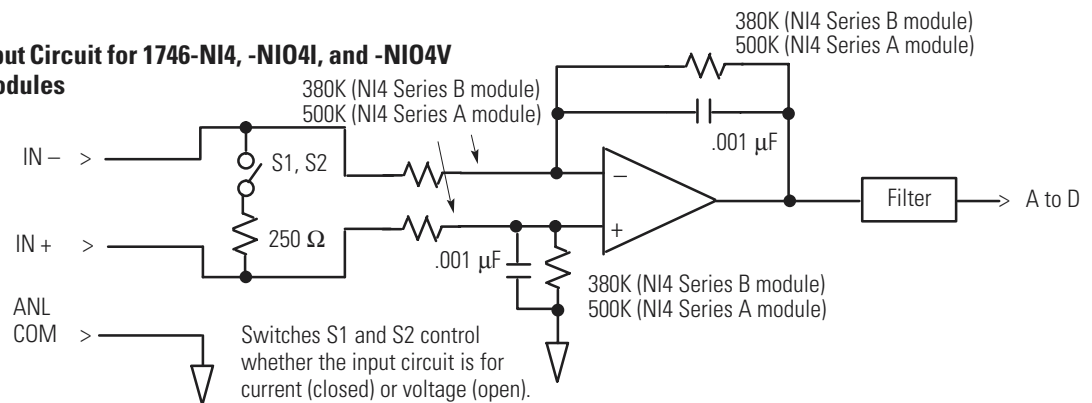

### Voltage Output Circuit for 1746-NI04V Modules

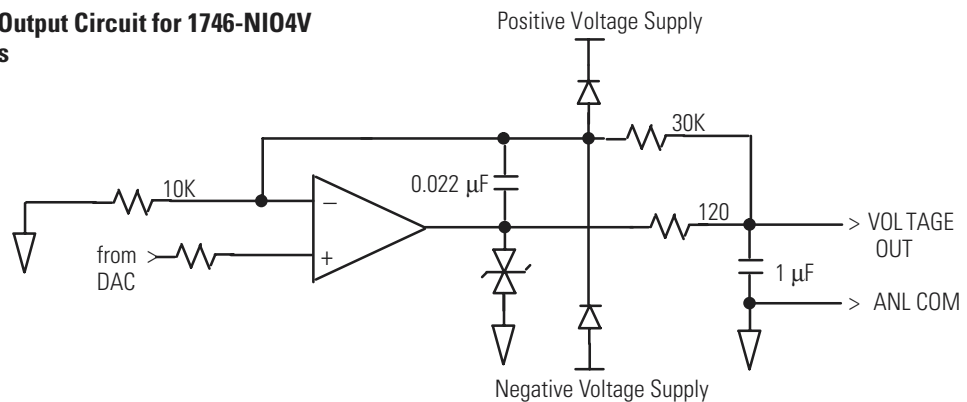

### Current Output Circuit for 1746-NI04I Modules

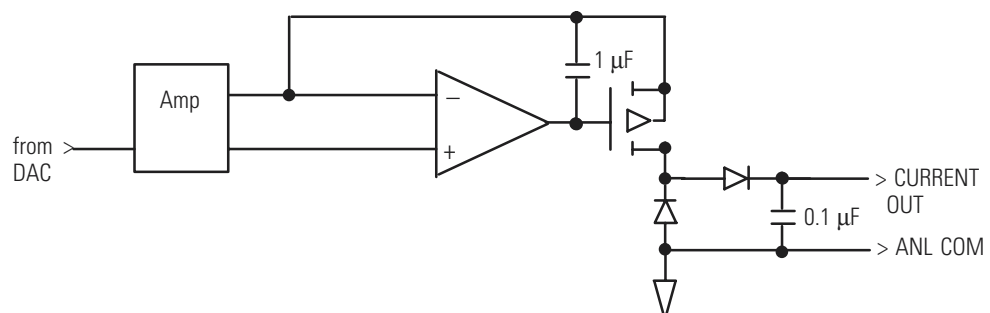

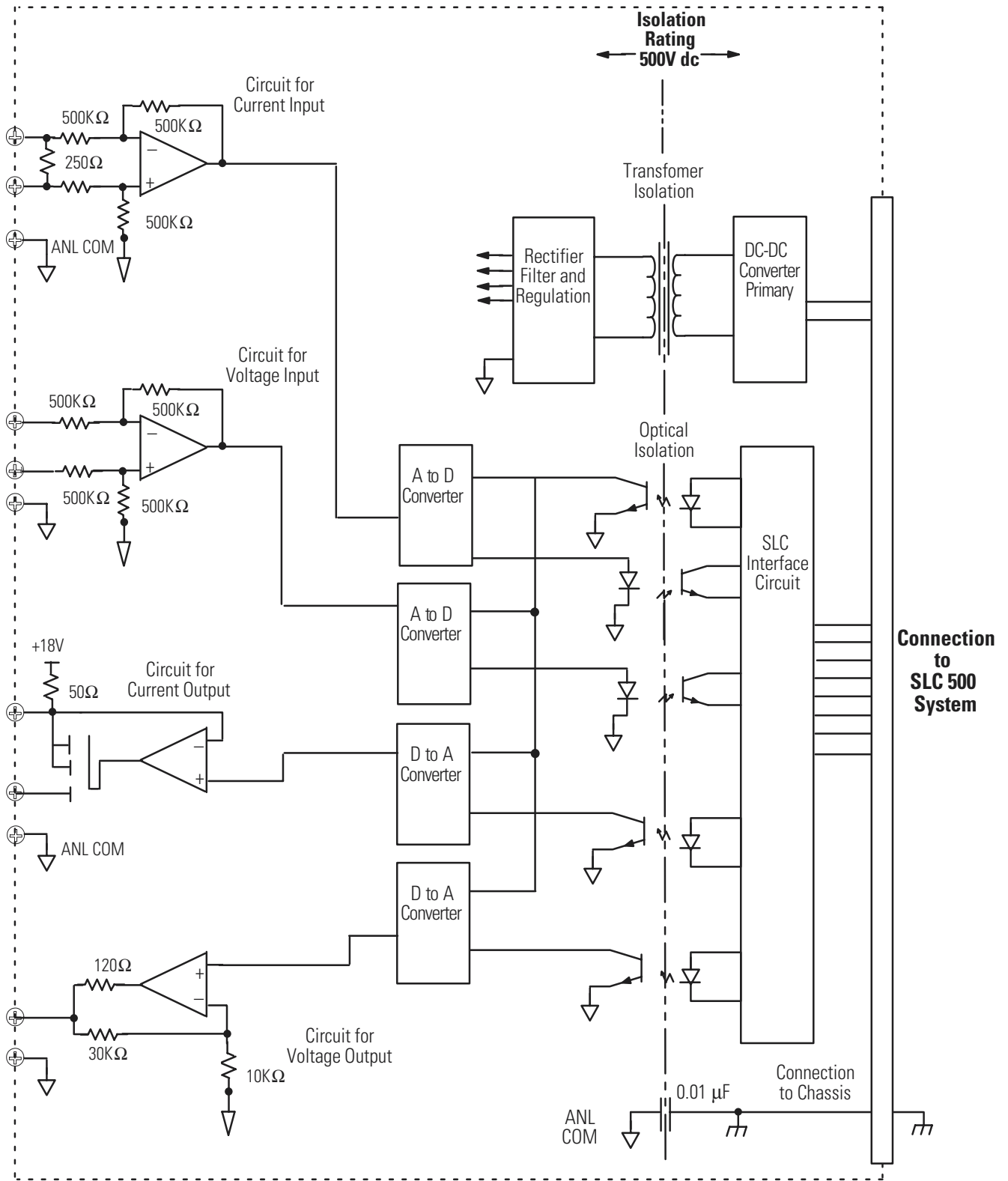

**Numerics**

- 1746-N04I and N04V Analog Output Modules** 1-2
- 1746-NI04I and NI04V Analog Combination Modules** 1-2
- 1746-NI4 Analog Input Module** 1-2

**A**

- Addressing Analog Modules** 4-1
- Addressing and Scaling Outputs**
  - Calculating the Linear Relationship 6-8
  - Using Standard Math 6-10
  - Using the Scale with Parameters (SCP) Instruction 6-12
- Addressing, OutofRange Detection, and Scaling of Analog Inputs**
  - Calculating the Linear Relationship 6-2
  - Calculating the OutofRange Flag Using the Scale Instruction 6-3
  - Using Standard Math 6-4
  - Using the Scale (SCL) Instruction 6-6
  - Using the Scale with Parameters (SCP) Instruction 6-8

**analog modules**

- addressing 4-1, 4-2
- configuring 3-5
- current output specifications A-5
- current-loop input A-3
- general specifications A-1
- inspecting 5-2
- installing 3-6
- preventative maintenance 7-1
- voltage input specifications A-4
- voltage output specifications A-6
- wiring 3-10

**B**

- Bit Level Addressing** 4-4

**C**

- Calculating the Software Calibration** A-2
- Calibrating an Analog Input Channel** A-1
- common techniques used in this manual** P-3
- Configuring Your Module**
  - External Power Switch for the 1746N04I and N04V 3-6
  - Switch Settings for the 1746NI04I and NI04V 3-5

- Converting Analog Input Data** 4-6
- Converting Analog Output Data** 4-7
- Current Output Circuit for 1746NI04I Modules** A-1

**D**

- Disconnect Prime Movers** 5-2

**E**

- equipment needed** 2-1

**G**

- getting started**
  - overview 2-1
- getting started quickly** 2-1

**I**

- Input Channel Filtering** 4-14
- Input Circuit for 1746NI4, NI04I, and NI04V Modules** A-1
- Input Response to Slot Disable** 4-13
- installation**
  - getting started 2-1

**M**

- manuals, related** P-2
- minimizing electrical noise** 3-15
- Module Input and Output Circuits**
  - Current Output Circuit for 1746NI04I Modules A-1
  - Input Circuit for 1746NI4, NI04I, and NI04V Modules A-1
  - Voltage Output Circuit for 1746NI04V Modules A-1
- module installation** 3-6
- Monitoring Input and Output Data** 4-5

**N**

- Negative Decimal Values** A-2
- NonRetentive Analog Output Example** 4-11

**O**

- Output Response to Slot Disable** 4-13

**P**

**Positive Decimal Values** A-1  
**power requirements for a fixed controller** 3-2  
**power requirements for a modular controller** 3-2  
**PowerUp the SLC 500 System** 5-3  
**Processor Update of Analog Data** 4-5  
**publications, related** P-2

## Q

**Quick Start for Experienced Users** 2-1

## R

**related publications** P-2  
**Required Tools and Equipment** 2-1  
**Response to Slot Disable** 4-13  
**Retentive Programming Option** 4-9

## S

**Scaling and Range Checking of Analog Inputs and Outputs**  
Calculating the Linear Relationship 6-21  
Using SCL Instruction 6-25  
Using Standard Math Instructions 6-22  
Using the Scale with Parameters (SCP) Instruction 6-26  
**Scaling Offset when >32,767 or 32,768**

Calculating the Linear Relationship 6-14  
Calculating the Linear Shifted Relationship 6-15  
Using Standard Math 6-16  
Using the Scale with Parameters (SCP) Instruction 6-18  
**startup instructions** 2-1  
**system start-up procedures** 5-1

## T

**terminal block**  
removing 3-7  
**Testing Analog Inputs** 5-4  
**Testing Analog Outputs** 5-6  
**Testing the SLC 500 System** 5-1  
**tools needed** 2-1  
**Two's Complement Binary Numbers**  
Positive Decimal Values A-1, A-2

## V

**Voltage Output Circuit for 1746NI04V Modules** A-1

## W

**Wiring Considerations**  
Grounding Your Cable 3-9







# Rockwell Automation Support

Rockwell Automation provides technical information on the web to assist you in using our products. At <http://support.rockwellautomation.com>, you can find technical manuals, a knowledge base of FAQs, technical and application notes, sample code and links to software service packs, and a MySupport feature that you can customize to make the best use of these tools.

For an additional level of technical phone support for installation, configuration and troubleshooting, we offer TechConnect Support programs. For more information, contact your local distributor or Rockwell Automation representative, or visit <http://support.rockwellautomation.com>.

## Installation Assistance

If you experience a problem with a hardware module within the first 24 hours of installation, please review the information that's contained in this manual. You can also contact a special Customer Support number for initial help in getting your module up and running:

United States	1.440.646.3223 Monday – Friday, 8am – 5pm EST
Outside United States	Please contact your local Rockwell Automation representative for any technical support issues.

## New Product Satisfaction Return

Rockwell Automation tests all of our products to ensure that they are fully operational when shipped from the manufacturing facility. However, if your product is not functioning and needs to be returned:

United States	Contact your distributor. You must provide a Customer Support case number (see phone number above to obtain one) to your distributor in order to complete the return process.
Outside United States	Please contact your local Rockwell Automation representative for return procedure.

Allen-Bradley is a registered trademark of Rockwell Automation.  
SLC and DTAM are trademarks of Rockwell Automation.  
Belden is a trademark of Belden, Inc.  
C-UL is a registered trademark of Underwriters Laboratories.

[www.rockwellautomation.com](http://www.rockwellautomation.com)

### Power, Control and Information Solutions Headquarters

Americas: Rockwell Automation, 1201 South Second Street, Milwaukee, WI 53204-2496 USA, Tel: (1) 414.382.2000, Fax: (1) 414.382.4444

Europe/Middle East/Africa: Rockwell Automation, Vorstlaan/Boulevard du Souverain 36, 1170 Brussels, Belgium, Tel: (32) 2 663 0600, Fax: (32) 2 663 0640

Asia Pacific: Rockwell Automation, Level 14, Core F, Cyberport 3, 100 Cyberport Road, Hong Kong, Tel: (852) 2887 4788, Fax: (852) 2508 1846

Publication 1746-UM005B-EN-P - June 2004

Supersedes Publication 1746-6.4 - January 1996

Copyright © 2004 Rockwell Automation, Inc. All rights reserved. Printed in the U.S.A.