

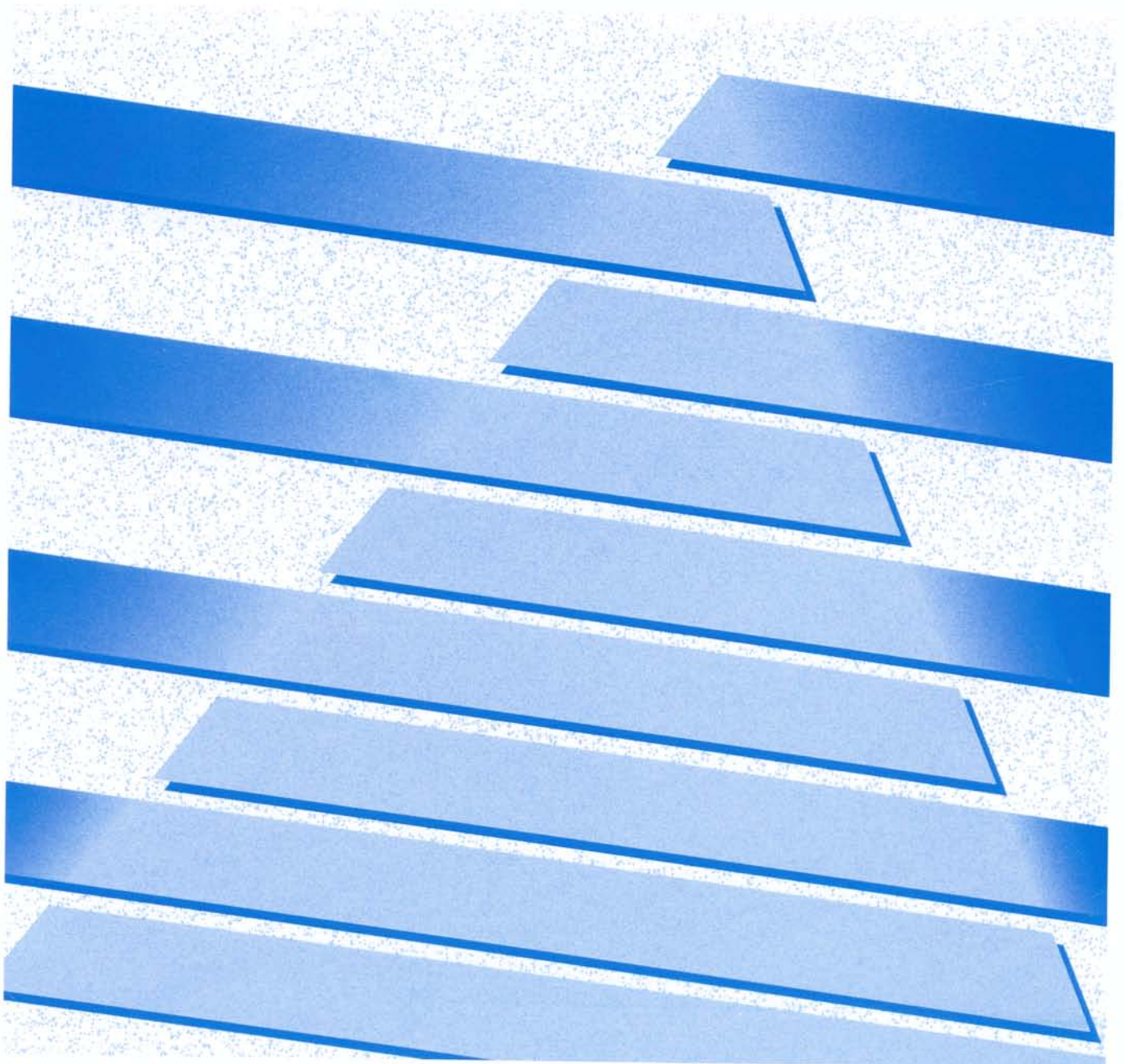

ALLEN-BRADLEY

Bulletin 5370 CVIM™
Configurable Vision Input Module
(Catalog No. 5370-CVIM)

User Manual



Important User Information

Solid state equipment has operational characteristics differing from those of electromechanical equipment. "Safety Guidelines for the Application, Installation and Maintenance of Solid State Controls" (Publication SGI-1.1) describes some important differences between solid state equipment and hard-wired electromechanical devices. Because of this difference, and also because of the wide variety of uses for solid state equipment, all persons responsible for applying this equipment must satisfy themselves that each intended application of this equipment is acceptable.

In no event will the Allen-Bradley Company be responsible or liable for indirect or consequential damages resulting from the use or application of this equipment.

The examples and diagrams in this manual are included solely for illustrative purposes. Because of the many variables and requirements associated with any particular installation, the Allen-Bradley Company cannot assume responsibility or liability for actual use based on the examples and diagrams.

No patent liability is assumed by Allen-Bradley Company with respect to use of information, circuits, equipment, or software described in this manual.

Reproduction of the contents of this manual, in whole or in part, without written permission of the Allen-Bradley Company is prohibited.

Table of Contents

Chapter	Title	Page
1	<i>Introduction: CVIM Machine Vision</i>	
	Chapter Objective	1-1
	CVIM Quick Start Self-Training Guide	1-1
	User Manual Objective	1-1
	User Experience	1-2
	CVIM Machine Vision: System Overview	1-2
	CVIM Operating Modes	1-3
	Stand-Alone Mode	1-3
	Hosted Mode	1-3
	Basic Hardware	1-4
	CVIM Module	1-4
	Pyramid Integrator Chassis	1-4
	Chassis Power Supply	1-4
	Video Monitors	1-5
	Light Pen	1-5
	Camera	1-6
	Interface Modules	1-6
	User Interface Box	1-6
	I/O Interface Box	1-6
	1771 JMB Interface Board	1-6
	Interconnecting Cables	1-7
	Communication Channels	1-7
	Discrete I/O Lines	1-7
	Remote I/O Port	1-8
	RS-232 Communications Port	1-8
	Chassis Backplane	1-8
	Warnings and Cautions	1-8
	Reference Publications	1-9
2	<i>CVIM Hardware Connection and Powerup Check</i>	
	Chapter Objectives	2-1
	CVIM System Components	2-1
	Connecting CVIM System Components	2-1
	Powering Up CVIM System	2-9
3	<i>CVIM User Interface</i>	
	Chapter Objective	3-1
	CVIM User Interface	3-1
	Light Pen	3-2
	Pointing and Highlighting	3-2
	Picking	3-2

Chapter	Title	Page
<hr/>		
3 (continued)		
	Dragging	3-3
	Placing	3-3
	Summary: Manipulating Symbols	3-3
	Graphic Figures	3-4
	Menus	3-4
	Tables	3-6
	Symbols	3-8
	Configuration Shortcut	3-9
	Help Messages	3-11
	Menu Removal Function	3-11
<hr/>		
4	Operating Environment	
	Chapter Objective	4-1
	Operating Environment	4-1
	Configuring Operating Environment	4-2
	Selecting <i>Environ</i> Popup Menu	4-2
	Selecting <i>System</i> Popup Menu and Parameters	4-3
	Selecting <i>Host Select</i> Popup Menu	4-3
	Selecting <i>Tool Display</i> Status	4-5
	Selecting <i>Monitor</i> Type	4-5
	Selecting <i>Units</i> Popup Menu	4-6
	Selecting <i>I/O</i> Popup Menu and Parameters	4-7
	Selecting <i>Output Assignment</i> Popup Menu ..	4-8
	Assigning Output Line Functions	4-9
	Selecting <i>RS-232</i> Parameters	4-12
	Selecting <i>1771 Remote I/O</i> Parameters	4-13
	Selecting <i>Tool Set</i> Popup Menu and Parameters	4-15
	Selecting <i>Tool Set #1</i> Camera and Trigger ...	4-16
	Selecting <i>Tool Set #2</i> Camera and Trigger ...	4-18
	Selecting Active Tool Set	4-20
<hr/>		
5	Camera and Lighting Parameters	
	Chapter Objectives	5-1
	Configuration Categories	5-1
	Configuring Camera and Lighting Parameters	5-2
	Selecting <i>Camera</i> Popup Menu and Parameters	5-2
	Selecting <i>Camera Type/Mode</i> Popup Menu	5-3
	Selecting <i>Shutter</i> Parameter	5-4

Chapter	Title	Page
5 (continued)		
	Using <i>Focus Camera</i> Function	5-6
	Selecting <i>Lighting/Resolution</i> Popup Menu and Parameters	5-7
	Selecting <i>Resolution</i> Popup Menu	5-8
	Setting <i>Light Reference</i> Threshold	5-10
	Selecting <i>Light Probe</i> Popup Menu and Parameters	5-12
	Selecting <i>Probe Status</i> Popup Menu	5-14
	Using <i>Pick & Place</i> Function	5-15
	Using <i>Learn</i> Function	5-18
	Assigning Range Limits and Output Lines	5-18
	Using <i>Object Calibration</i> and <i>Grid Calibration</i> ...	5-25
	Selecting <i>Object Calibration</i> Functions and Parameters	5-26
	Using <i>Pick & Place</i> Function	5-27
	Defining Edges	5-33
	Performing <i>Calibrate</i> Function	5-34
	Entering Calibration Object Dimensions	5-34
	Selecting <i>Grid Calibration</i> Functions and Parameters	5-36
	Using <i>Pick & Place</i> Function	5-38
	Defining Edges	5-44
	Entering Calibration Grid Dimensions	5-46
	Performing <i>Calibrate</i> Function	5-48
6	<i>Reference Tools: Lines and Windows</i>	
	Chapter Objectives	6-1
	A Few Questions and Answers	
	About Reference Tools	6-1
	Reference Lines	6-2
	Using Reference Lines	6-2
	Configuring Reference Lines	6-8
	Selecting <i>Ref. Line</i> Popup Menu	6-9
	Selecting and Enabling Reference Line	6-9
	Selecting <i>Define Ref. Line</i> Popup Menus and Parameters	6-10
	Selecting <i>Ref. Line Type</i> Popup Menu	6-10
	Selecting Active Reference Line	6-14
	Selecting <i>Binary or Gray Scale</i> Mode	6-15
	Using <i>Pick and Place</i> Function	6-16
	Using <i>Define Edges</i> Function:	
	Binary Mode	6-20
	Using <i>Define Edges</i> Function:	
	Gray Scale Mode	6-23

Chapter	Title	Page
6	<i>(continued)</i>	
	Selecting <i>Define Features</i> Popup Menu and Parameters	6-25
	Selecting Active Feature	6-26
	Selecting Search Direction	6-26
	Selecting <i>S. Mode</i> Popup Menu	6-27
	Using <i>Offset</i> Function	6-31
	Using <i>Learn</i> Function	6-34
	Selecting <i>Output/Reference</i> Popup Menu and Parameters	6-34
	Selecting <i>Output Line Selection</i> Popup Menu	6-35
	Selecting <i>Reference</i> Popup Menu	6-36
	Reference Windows	6-38
	Using Reference Windows	6-38
	Shift-Only Example	6-39
	Rotation and Shift Example	6-43
	Selecting Workpiece Features	6-49
	Configuring Reference Windows	6-50
	Selecting <i>Ref. Win</i> Popup Menu	6-51
	Selecting and Enabling Reference Window	6-51
	Selecting <i>Define Features</i> Popup Menu and Parameters	6-52
	Selecting Active Feature	6-52
	Using <i>P&P Feature Win.</i> Function	6-53
	Using <i>Feature Disp</i> Function	6-59
	Using <i>P&P Search Win.</i> Function	6-59
	Understanding <i>Set Score</i> Function	6-60
	Determining <i>Set Score</i> Value	6-61
	Using <i>Set Score</i> Function	6-66
	Using <i>Find Feature</i> Function	6-67
	Using <i>Learn</i> Function	6-68
	Selecting <i>Output/Reference</i> Popup Menu and Parameters	6-71
	Selecting <i>Output Line Selection</i> Popup Menu	6-71
	Selecting <i>Reference</i> Popup Menu	6-73
7	<i>Inspection Tools: Gages</i>	
	Chapter Objectives	7-1
	A Few Questions and Answers	
	About Gages	7-1
	Gages	7-2
	Using Linear Gages	7-2
	Using Circular Gages	7-6
	Configuring Gages	7-9
	Selecting <i>Gage</i> Popup Menu	7-10
	Selecting and Enabling <i>Gage</i>	7-10

Chapter	Title	Page
7 (continued)		
	Selecting <i>Define Gage</i> Popup Menu and Parameters	7-11
	Selecting <i>Gage Shape</i>	7-11
	Selecting <i>Operation</i> Popup Menu	7-12
	Selecting <i>Gaging Mode</i> Popup Menus	7-14
	Using <i>Pick and Place</i> Function	7-16
	Using <i>Define Edges</i> Function:	
	Binary Gaging Mode	7-32
	Using <i>Define Edges</i> Function:	
	Gray Scale Gaging Mode	7-35
	Selecting <i>Define Features</i> Popup Menu and Parameters	7-37
	Selecting Active Feature	7-38
	Selecting Search Direction	7-38
	Selecting <i>S. Mode</i> Popup Menu	7-39
	Using <i>Offset</i> Function	7-43
	Using <i>Learn</i> Function	7-45
	Selecting <i>Range/Reference</i> Popup Menu and Parameters	7-45
	Assigning Range Limits and Output Lines	7-46
	Selecting <i>Reference</i> Popup Menu	7-54
8	<i>Inspection Tools: Windows</i>	
	Chapter Objectives	8-1
	A Few Questions and Answers	
	About Windows	8-1
	Windows	8-2
	Using Rectangular Windows	8-2
	Using Elliptical Windows	8-5
	Using Masks With Windows	8-9
	Using Polygonal Windows	8-10
	Configuring Windows	8-11
	Selecting <i>Window</i> Popup Menu	8-12
	Selecting and Enabling Window	8-12
	Selecting <i>Define Window</i> Popup Menu and Parameters	8-13
	Selecting <i>Window Shape</i>	8-13
	Using <i>P&P Process Win.</i> Function	8-15
	Selecting <i>Window Mask</i> Popup Menu	8-26
	Using <i>P&P Mask Win.</i> Function	8-27
	Selecting <i>Window Operation</i> Popup Menu ..	8-28
	Configuring <i>#Obj's</i> Operations	8-30
	Using <i>Threshold/Filter</i> Function (Pixel and Object Counts)	8-34
	Using <i>Pixel/Obj Filter</i> Menu	8-36

Chapter	Title	Page
8 (continued)		
	Configuring <i>Gradient</i> Operations	8-37
	Using <i>Threshold/Filter</i> Function (Gradient) ..	8-39
	Using <i>Gradient</i> Menu	8-40
	Configuring <i>Template Match</i> Operations	8-43
	Using <i>Learn</i> Function	8-46
	Selecting <i>Range/Reference</i> Popup Menu and Parameters	8-46
	Assigning Range Limits and Output Lines	8-47
	Selecting <i>Reference</i> Popup Menu	8-55
9	<i>Configuration Aids and Storage Functions</i>	
	Chapter Objectives	9-1
	Configuration Aids and Storage: Overview	9-1
	Using Configuration Aids and Storage Functions ..	9-1
	Selecting <i>Misc</i> Popup Menu	9-2
	Selecting <i>Archival</i> Popup Menu	9-2
	Using <i>Set Archive Names</i> Function	9-4
	Using <i>Save Config. (Int)</i> Function	9-6
	Using <i>Load Config. (Int)</i> Function	9-6
	Using <i>Load Default Config</i> Function	9-7
	Preparing RAM Card	9-9
	Using <i>Format Card</i> Function	9-11
	Using <i>Save to Card</i> Function	9-12
	Using <i>Load From Card</i> Function	9-13
	Selecting <i>Snapshot</i> Popup Menu	9-15
	Using <i>Acquire Image</i> Function	9-15
	Using <i>Display Test Image</i> Function	9-15
	Selecting <i>Analysis</i> Popup Menu	9-16
	Using <i>Tool Display</i> Function	9-17
	Using <i>Analyze Image</i> Function	9-18
	Using <i>Snap & Analyze</i> Function	9-18
	Using <i>Continuous S & A</i> Function	9-19
	Selecting <i>Registration</i> Popup Menu	9-19
	Using <i>Tool Display</i> Function	9-21
	Using <i>Snap & Register</i> Function	9-22
	Using <i>Continuous S & R</i> Function	9-22
	Using <i>Register to Image</i> Function	9-23
	Using <i>Learn Registration</i> Function	9-23
10	<i>Runtime Functions</i>	
	Chapter Objectives	10-1
	Runtime Functions: Overview	10-1

Chapter	Title	Page
10 (continued)		
	Using Runtime Functions	10-1
	Selecting <i>Exit</i> Popup Menu	10-1
	Selecting <i>Runtime Init.</i> Popup Menu	10-2
	Selecting Halt Status	10-4
	Selecting Freeze Status	10-4
	Selecting Output Line Status	10-5
	Selecting Operating Mode Status	10-5
	Selecting <i>Reset Counters</i> Function	10-6
	Selecting <i>Runtime Arm</i> Popup Menu	10-6
	Selecting <i>Runtime Display</i> Popup Menu	10-7
	Selecting <i>Runtime</i> Popup Menu	10-9
	Selecting <i>Save Config. (Int)</i> Function	10-9
	Selecting <i>Goto Runmode</i> Function	10-10
	Interpreting Run Mode Displays	10-11
	Image Only	10-11
	Failed Tools	10-11
	All Tools	10-11
	I/O Page	10-12
	Results Page	10-16
	Stat 1 Page	10-19
	Stat 2 Page	10-20
	Displaying Other Tool Set	10-21
	Using Run Mode Halt and Freeze Functions	10-21

Appendix A	<i>Planning Discrete I/O Assignments and Connections</i>	
	Appendix Objective	A-1
	Planning Output Line Assignments	A-1
	Using Output Line Planning Sheet	A-1
	Using Output Signal Timing Data	A-5
	Planning Output Line Connections	A-8
	Planning Connections to RS-232 Connector	A-9
	Planning I/O Connections to 1771-JMB Board	A-9
	Output Line Planning Sheet	A-12

Appendix B	<i>Planning System Configuration</i>	
	Appendix Objective	B-1
	System Configuration Planning	B-1
	Configuration Planning Tables	B-1
	<i>System</i> Parameters	B-1
	I/O Parameters (1 of 2)	B-2
	I/O Parameters (2 of 2)	B-2

<i>Chapter</i>	<i>Title</i>	<i>Page</i>
Appendix B (continued)		
	<i>Tool Set Parameters</i>	B-3
	<i>Camera Parameters</i>	B-3
	<i>Reference Line Parameters (1 of 3)</i>	B-4
	<i>Reference Line Parameters (2 of 3)</i>	B-4
	<i>Reference Line Parameters (3 of 3)</i>	B-5
	<i>Reference Window Parameters</i>	B-5
	<i>Gage Parameters (1 of 6)</i>	B-6
	<i>Gage Parameters (2 of 6)</i>	B-7
	<i>Gage Parameters (3 of 6)</i>	B-8
	<i>Gage Parameters (4 of 6)</i>	B-9
	<i>Gage Parameters (5 of 6)</i>	B-10
	<i>Gage Parameters (6 of 6)</i>	B-11
	<i>Window Parameters (1 of 4)</i>	B-12
	<i>Window Parameters (2 of 4)</i>	B-13
	<i>Window Parameters (3 of 4)</i>	B-14
	<i>Window Parameters (4 of 4)</i>	B-15

Appendix C**Definition of Terms**

Appendix Objective	C-1
Definition of Terms	C-1

<i>Figure</i>	<i>Title</i>	<i>Page</i>
List of Figures		
1.1	CVIM System Components and Connections	1-2
3.1	CVIM Interface: Light Pen and Graphic Figures	3-1
3.2	Run Mode and Main Configuration Menus	3-4
3.3	Two Popup Menus	3-5
3.4	Configuration and Statistics Tables	3-6
3.5	Inspection Statistics Table	3-7
3.6	Inspection Results Table	3-7
3.7	Symbols for Linear Gage and Handles	3-8
3.8	Linear Gage Ready for Manipulation	3-8
3.9	Light Pen Manipulation of Gage Symbol	3-9
3.10	Configuration Shortcut	3-10
6.1	Reference Line Positioned Across Bottle	6-4
6.2	Linear Gage Positioned Vertically Over Bottle	6-5
6.3	Edge Locations on Shifted Bottle and Original Bottle ..	6-6
6.4	Linear Gage After Shift Compensation	6-7
6.5	Single "Active Feature" Positioned Over Feature on Plate	6-40
6.6	Linear Gage Positioned Over Hole in Plate	6-41
6.7	Shifted Plate Compared to Original Plate	6-42

<i>Figure</i>	<i>Title</i>	<i>Page</i>
List of Figures (continued)		
6.8	Rotated and Shifted Plate Compared to "Original" Unrotated Plate	6-43
6.9	Two "Active Features" Positioned Over Features on Plate	6-44
6.10	Datum Lines and Reference Angle for Rotation Compensation	6-45
6.11	Basis for Determining Rotation Compensation	6-46
6.12	Datum Line and Midpoint for Shift Compensation	6-47
6.13	Basis for Determining Shift Compensation	6-48
7.1	Linear Gage Configured to Measure Head-to-Edge	7-3
7.2	Linear Gage Configured to Measure Edge-to-Edge Distance	7-4
7.3	Linear Gage Measuring Liquid Level on Shifted Bottle	7-5
7.4	Circular Gage Configured to Count Edges or Pixels	7-7
7.5	Circular Gages Configured to Measure Width of a Tooth	7-8
8.1	Screen Image of Metal Plate	8-3
8.2	Rectangular Window Around Metal Plate	8-4
8.3	Rectangular Window Positioned Around Holes in Metal Plate	8-5
8.4	Circular Windows Around Holes in Metal Plate	8-6
8.5	Looking Into Open End of Cylinder With and Without O-Ring	8-7
8.6	Circular Window Positioned Over End of Cylinder	8-8
8.7	Circular Window with Mask Positioned Over End of Cylinder	8-9
8.8	Polygonal Window Around Screws in Workpiece	8-10

Chapter 1 Introduction: CVIM Machine Vision

Chapter Objective

The objective of this chapter is to introduce you to the Allen-Bradley 5370 CVIM (Configurable Vision Input Module) machine vision system and explain the main objective of this manual.

CVIM Quick Start Self-Training Guide

Before you use this manual, you should first acquaint yourself with the *CVIM Quick Start Self-Training Guide*, Catalog No. 5370-ND003.

The quick-start guide steps you through the basics of the CVIM user interface. It explains the popup menus and graphic symbols on the video monitor screen, and it shows you how to use the light pen to select the menus and manipulate the symbols on the monitor screen.

User Manual Objective

The objective of the CVIM User Manual is to provide the information and procedures you need to prepare your CVIM system for an inspection application.

First, Chapter 2 steps you through the procedures for connecting the CVIM components, powering up the system, and checking the system's status. For *complete* installation instructions, refer to the Allen-Bradley Pyramid Integrator Installation Manual, Publication 5000-6.2.10.

Second, Chapter 3 introduces you to the CVIM user interface and shows you how to use it.

Third, Chapters 4 through 10 step you through the procedures for configuring system parameters and analysis tools, storing configurations, and operating the CVIM system and observing inspection results.

Where appropriate, the user manual provides one or more simple examples to help you understand the concepts involved in a particular feature or function. Following an example, the user manual provides the step-by-step instructions for configuring the feature or function.

Of course, your application may not require *all* of the CVIM system's capabilities. In that case, you need refer only to the chapters or sections that your application requires.

NOTE: It is beyond the scope of this manual to show you how to configure your CVIM system for *specific* applications.

User Experience

This manual and the CVIM system are intended for technical operators with little or no programming experience. However, if you are integrating the CVIM system into an existing programmable logic controller (PLC) system, experience in PLC operation would be helpful. You should be familiar with the Allen-Bradley line of PLCs and have some Ladder-Logic programming experience.

**CVIM Machine Vision:
System Overview**

The CVIM system provides a flexible, easy-to-configure machine vision system, with powerful analysis tools, for a large variety of manufacturing inspection applications.

The system consists of several modules and peripheral components. This includes the CVIM module, a chassis and power supply, a video monitor, and one or two cameras.

Figure 1.1 identifies, in symbolic form, the basic CVIM system components and shows the connections between these components and the external equipment.

Figure 1.1 CVIM System Components and Connections

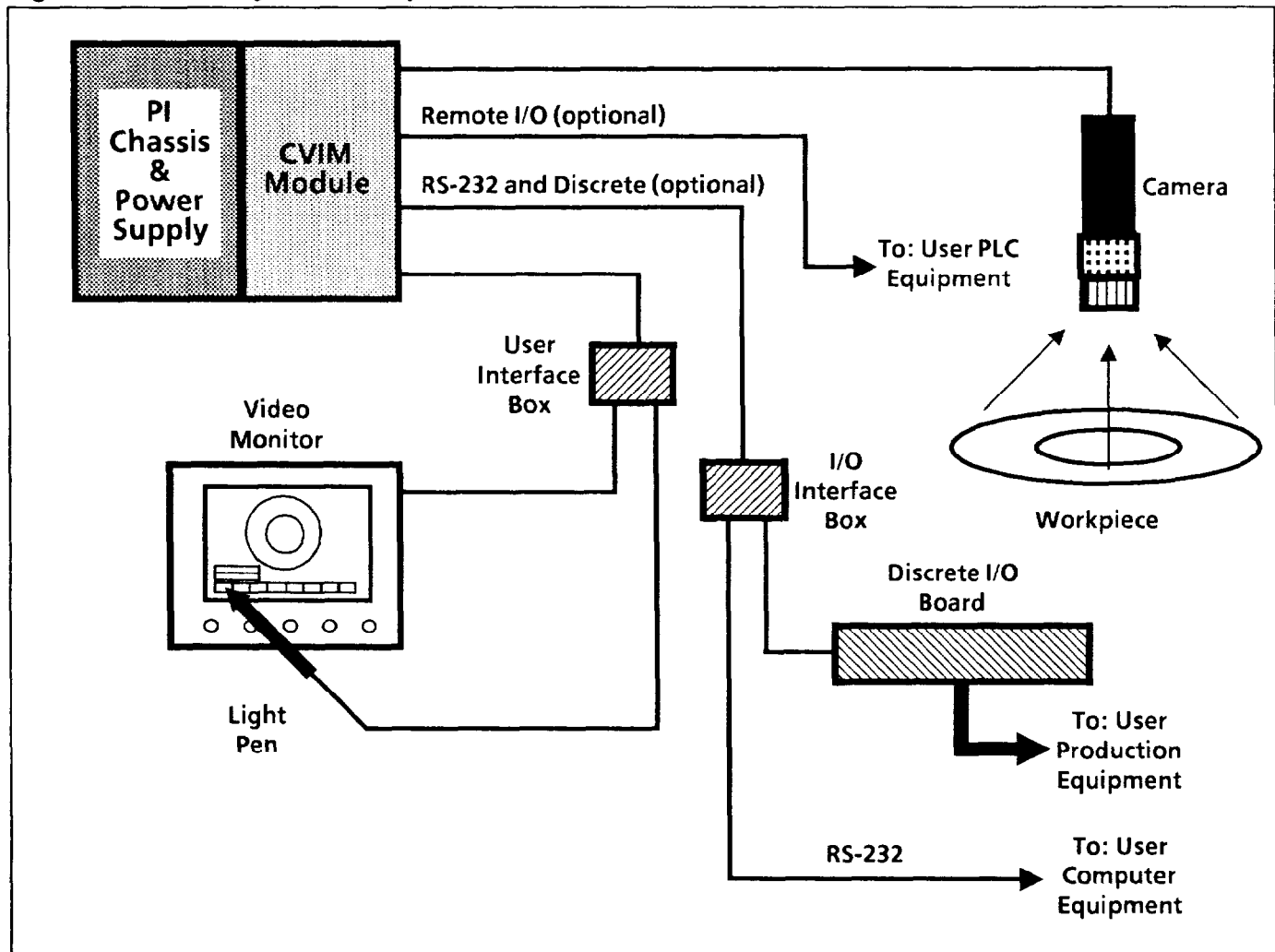

**CVIM Machine Vision:
System Overview**
(continued)

During CVIM system configuration, you will be using the light pen and the video monitor to prepare the CVIM system for inspection tasks.

During an inspection cycle, the solid state camera acquires an image of the item to be inspected (the "workpiece") and sends it to the CVIM module. There, specialized machine vision circuitry digitizes the image and displays it on the video monitor, then analyzes designated parts of the image using its analysis tools.

The CVIM module sends the results of that analysis – a "pass/fail" signal – to your production equipment, which can accordingly accept or reject the workpiece.

CVIM Operating Modes

The CVIM machine vision system can operate as a stand-alone vision system or as a hosted system, in which the CVIM system interacts with a host system through the chassis backplane or through a front panel port.

Stand-Alone Mode

The term "stand-alone mode" means that CVIM system control takes place through a set of discrete I/O lines connected to your production equipment.

In this mode, the CVIM system receives trigger signals *directly* from your production equipment, and sends inspection results signals *directly* to that equipment. These signals are routed to your production equipment through a discrete I/O port on the CVIM module's front panel.

Hosted Mode

The term "hosted mode" means that one of the three CVIM communications ports is designated as the *host*: the remote I/O port, the RS-232 port, and the chassis backplane. You can designate only one as host at any given time.

In this mode, only the designated host can issue commands to control CVIM operation, trigger inspections, upload and download configurations, and change displays.

Data, however, can be accessed through all three ports *simultaneously*. This means that your computer or PLC equipment can read discrete bits and numerical results information through any of the three ports, regardless of which is the designated host.

Basic Hardware This section identifies and briefly describes the basic hardware components for a CVIM system, namely:

- CVIM module.
 - Pyramid Integrator chassis.
 - Chassis power supply.
 - Video monitor.
 - Light pen.
 - Camera.
 - Interface modules.
 - Interconnecting cables.
-

CVIM Module The CVIM module contains all of the machine vision circuitry – the hardware and software that analyze the camera's image and control the communications. The module occupies one slot in the chassis.

Communications between the CVIM module and other modules in the same chassis take place through the chassis backplane.

Communications between the CVIM module and external devices take place through the front panel ports.

Pyramid Integrator Chassis Two Pyramid Integrator chassis are available: One has four slots, and the other has eight slots.

The 4-slot chassis can accommodate up to four CVIM modules, and the 8-slot chassis can accommodate up to eight modules.

Chassis Power Supply The chassis power supply plugs into the leftmost slot of the chassis, which is dedicated to the power supply. The power supply requires an input voltage range of either 90 to 132 VAC or 180 to 264 VAC.

The power supply provides the following DC voltage and amperage outputs:

- +5VDC @ 35A.
- +12VDC @ 800mA.
- -12VDC @ 800mA.

Chassis Power Supply
(continued)

An external +24 VDC power supply may be needed for applications that require several cameras. If so, the chassis power supply has a front panel input connection for the +24VDC source. This connection can also carry fan status signals from an optional fan chassis.

Allen-Bradley offers two cable assemblies for connecting the 24VDC power supply to the chassis power supply. The first assembly carries only the +24VDC. The second carries fan status from the fan chassis as well as +24VDC from the external power supply.

Video Monitors

A video monitor is required to configure the CVIM system for its inspection applications. During CVIM system operation, the monitor can also be used to observe inspection results.

The monitor screen displays the image from the camera and the popup menus and graphic symbols from the CVIM module. These menus and symbols, along with the light pen, are used to configure the CVIM system.

Allen-Bradley offers three video monitors: 9-inch and 12-inch monochrome monitors, and a 13-inch rack-mounted color monitor. The 9-inch monochrome monitor is available in 115VAC and 230VAC versions.

NOTE: The procedures described in this manual are based on the assumption that you have a color monitor.

Light Pen

Like the video monitor, the light pen is required to configure the CVIM system for its inspection applications.

The light pen has a light-sensitive sensor and a spring-loaded switch in its tip. Light from the monitor screen reaches the sensor through a small hole in the tip. The tip activates the switch when you press the tip against the monitor screen.

You operate the light pen by pressing its tip against a popup menu or other symbol on the monitor screen. This generates signals from the sensor and switch. The CVIM system uses the timing of these signals to determine the appropriate response.

Together, the light pen and the screen symbols form the user interface, which is the means by which you configure the CVIM system for its inspection tasks. Chapter 3, *CVIM User Interface*, describes the user interface in detail.

Camera Allen-Bradley offers a solid state camera for use with the CVIM system. One CVIM module can accommodate two cameras.

The low voltage DC power for the camera comes from either the chassis power supply or from an external DC power supply. The chassis power supply is generally sufficient for applications using one or two cameras.

Interface Modules The CVIM system uses two interface modules or "boxes" and one printed circuit board to distribute signals:

- The user interface box.
- The I/O interface box.
- The 1771 JMB interface board.

User Interface Box

This box receives video signals from the CVIM module through the user interface cable. It routes the video signals to the monitor through a single coaxial cable (monochrome) or four coaxial cables (color).

The user interface box also receives switch and light sensor signals from the light pen, and routes them to the CVIM module through the user interface cable.

Finally, the user interface box receives +5 VDC from the CVIM module, which it uses to energize itself and the light sensor in the light pen.

I/O Interface Box

This box routes discrete I/O signals between a 1771-JMB I/O board (described below) and the CVIM module. The I/O interface module connects directly to the 1771-JMB board.

The I/O interface box also routes RS-232 data communication signals between the CVIM module and host computer equipment. The box uses a 9-pin D-type connector to carry the RS-232 signals.

1771 JMB Interface Board

This board routes discrete input and output signals between the I/O interface box and your production equipment. The JMB board connects directly to the I/O interface box.

The JMB board contains up to 16 optically isolated discrete I/O modules, 14 of which are for output signals from the CVIM module and two of which are for input signals from your production equipment.

The JMB board contains an LED for each I/O module. An LED turns on whenever the associated I/O module receives a signal.

Interconnecting Cables

Since the CVIM system consists of separate components, it requires a number of interconnecting cables to join these components.

Briefly, these are the cables:

- **Camera cables** – Catalog No. 2801-NC14, -NC15, and NC-16 connect the camera(s) directly to the CVIM module.
 - **User interface cables** – Catalog No. 2801-NC18A, -NC18B, and -NC18C connect the CVIM module to the user interface box.
 - **I/O cable** – Catalog No. 2801-NC17 connects the CVIM module to the I/O interface box.
 - **Video monitor cable(s)** – Catalog No. 2801-NC2 and -NC3 connect the video monitor to the user interface box. (The monochrome monitor uses one cable; the color monitor uses four cables.)
-

Communication Channels

The CVIM module has four channels for communicating with other equipment:

- Sixteen discrete I/O lines.
 - A remote I/O port.
 - An RS-232 communications port.
 - The chassis backplane.
-

Discrete I/O Lines

The CVIM system provides 16 discrete I/O lines, whose signals enable direct interaction between the system and your production equipment.

Of the 16 lines, two are “trigger signal” lines. These are dedicated *input* lines, which are equipped to carry signals from part-presence sensors. The other 14 lines are all dedicated *output* lines, whose functions you can assign during CVIM system configuration.

The CVIM module has a special front panel port (called Module I/O) that routes both RS-232 data and discrete I/O signals to the I/O interface box.

The discrete I/O signals from the I/O interface box connect directly to the 1771 JMB board through an edge connector on the JMB board. I/O modules on the JMB board provide electrical isolation between your production equipment and the CVIM system.

Remote I/O Port The CVIM system has a remote I/O port for carrying data between the CVIM system and a 1771-based PLC (programmable logic controller) system.

Input data consists of configuration parameters or control commands. Output data consists of configuration parameters, inspection results, and CVIM module status.

RS-232 Communications Port The CVIM system has an RS-232 serial communications port for carrying data between the CVIM system and computer equipment or a PLC system.

Input data consists of configuration parameters or control commands. Output data consists of configuration parameters, inspection results, and CVIM module status.

Chassis Backplane When the chassis has other modules (such as a PLC 5/250) installed, the CVIM system can use the chassis backplane to carry data between the CVIM system and the other modules.

Input data consists of configuration parameters or control commands. Output data consists of configuration parameters, inspection results, and CVIM module status.

Warnings and Cautions Warnings and cautions occasionally appear in this manual. They are included in order to protect both you and the equipment. They appear as follows:



CAUTION: A caution symbol is used when the equipment could be damaged or performance seriously impaired if stated procedures are not followed.



WARNING : A warning symbol means that a person may be injured if the stated procedures are not followed.

Reference Publications

The following Allen-Bradley publications are referenced in this manual:

- The CVIM Quick Start Self-Training Guide, Catalog No. 5370-ND003.
- The CVIM Communications Manual, Catalog No. 5370-ND002.
- Pyramid Integrator Installation Manual, Publication No. 5000-6.2.10.
- Grounding and Wiring Guidelines, Publication No. 1777-4.1.
- Solid State Control Safety Guidelines, Publication No. SGI-1.1.

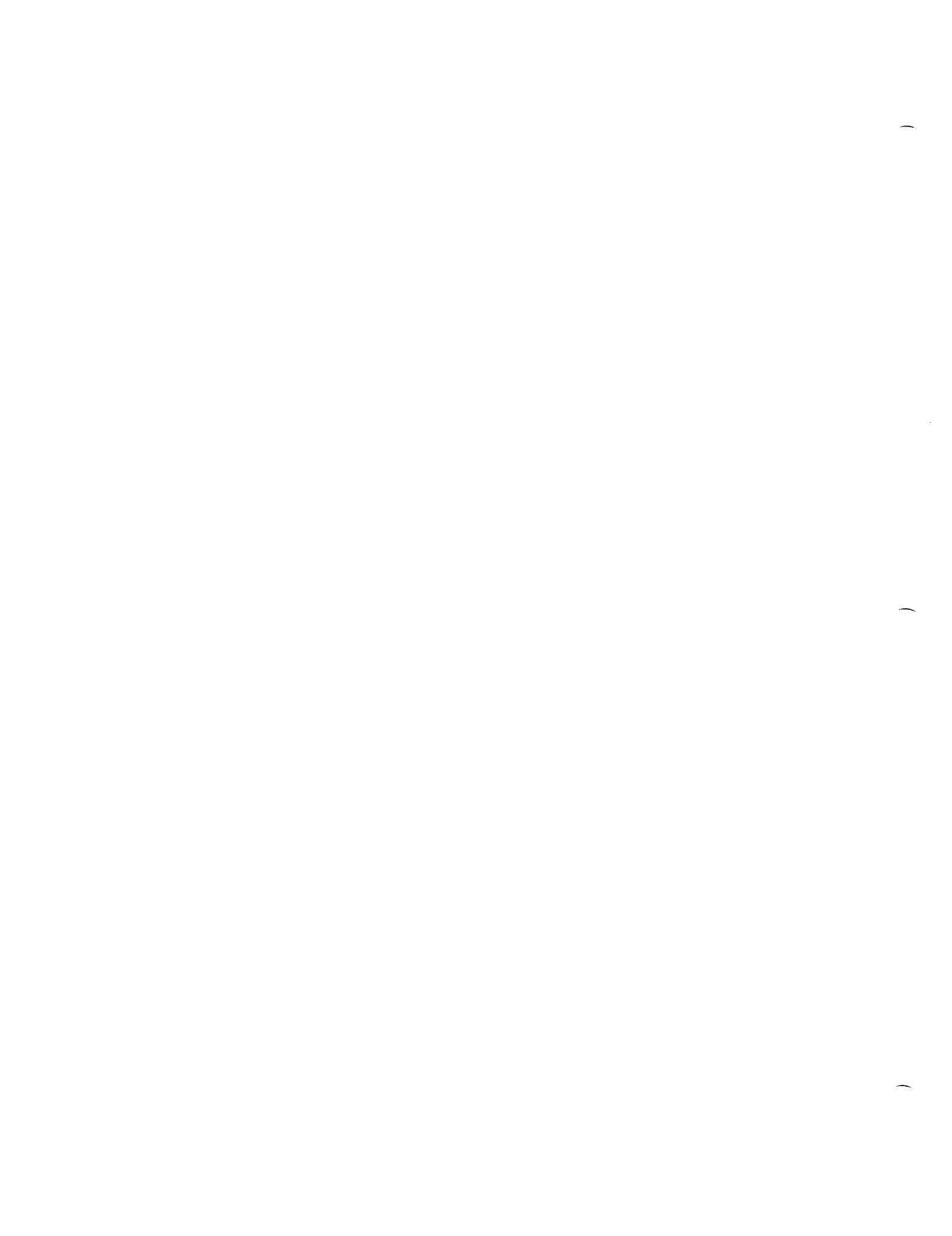

Chapter 2 CVIM Hardware Connection and Powerup Check

Chapter Objectives

The objectives of this chapter are to show you how to connect the CVIM system components and perform a powerup check.

CVIM System Components

The procedures in this chapter cover only those components that are related to the CVIM machine vision system, namely:

- CVIM module, Catalog No. 5370-CVIM.
- Pyramid Integrator chassis:
 - Four-slot chassis, Catalog No. 5110-A4.
 - Eight-slot chassis, Catalog No. 5110-A8.
- Chassis power supply, Catalog No. 5120-P1.
- Video monitor:
 - Color, 13-inch, rack-mounted, 115VAC, Catalog No. 2801-N8.
 - Monochrome, 9-inch, 115VAC, Catalog No. 2801-N9.
 - Monochrome, 9-inch, 230VAC, Catalog No. 2801-N20.
 - Monochrome, 12-inch, 115VAC, Catalog No. 2801-N6.
- Light pen, Catalog No. 2801-N7.
- Camera, Catalog No. 2801-YC.
- Interface modules:
 - User interface box, Catalog No. 2801-N22.
 - I/O interface box, Catalog No. 2801-N21.
 - Interface board, Catalog No. 1771-JMB.
- Interconnecting cables.

Additional components may be required for some CVIM system configurations. These will be identified in the connection procedures.

For complete information on installing the CVIM system in its factory floor location, refer to the Allen-Bradley Pyramid Integrator Installation Manual, Publication 5000-6.2.10, which is supplied with the CVIM module.

Connecting CVIM System Components

Before you install the CVIM system at its factory-floor site, you may find it useful to connect the basic system components temporarily on a workbench or table top.

There, away from the noise and distractions typically present on a factory floor, you can perform the powerup check and use the *CVIM Quick Start Self-Training Guide*, Catalog No. 5370-ND003, to get acquainted with the user interface.

Connecting CVIM System Components (continued)

If, however, you intend first to install the CVIM system at its factory-floor site, refer to the following Allen-Bradley publications for site installation information.

- Pyramid Integrator Installation Manual, Publication No. 5000-6.2.10. Chapter 4, *Grounding the Components*, is of particular importance.
- Grounding and Wiring Guidelines, Publication No. 1777-4.1.
- Solid State Control Safety Guidelines, Publication No. SGI-1.1.

After completing the site installation, return to this section.

Use the following steps to connect the CVIM system components and perform the powerup check.

Your Action

Place the chassis backside down on the work surface.

Pull the DC/PWR LOCK handle out as far as it will go.

Remove any foreign material from inside the chassis.

Locate the AC voltage-selection switch on the chassis power supply.

Comments

This handle is at the bottom edge of the chassis.

This is a slide switch near the bottom edge of the power supply module.

NOTE: No disassembly is required to access this switch.

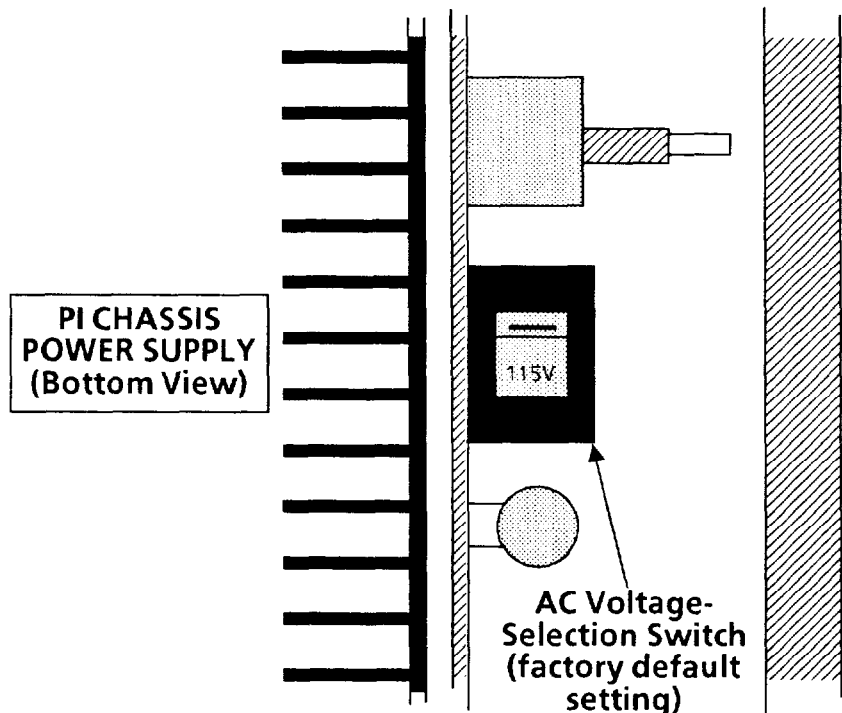

Connecting CVIM System Components (continued)

Your Action	Comments
<p><i>Set the voltage-selection switch to match the AC input voltage.</i></p> <p><i>Install the power supply module in the chassis.</i></p>	<p>The chassis power supply operates within one of the following two input voltage <i>ranges</i>:</p> <ul style="list-style-type: none"> ● <i>Low Range</i>: 90 to 132 VAC @47 to 63 Hz. ● <i>High Range</i>: 180 to 264 VAC @ 47 to 63Hz. <p>Use the 115V setting for input voltages in the <i>low</i> range. Use the 230V setting for input voltages in the <i>high</i> range.</p> <p>Carefully align the power supply with the <i>leftmost</i> slot in the chassis. Slide the power supply into the chassis and press down to seat the module.</p> <p>Finally, tighten the thumb screws evenly to secure the power supply.</p> <p>NOTE: Do <i>not</i> push in the DC PWR/LOCK handle yet.</p>
<p><i>Obtain an AC line cord for the chassis power supply.</i></p> <p><i>Attach one end of the line cord to a plug.</i></p>	<p>Use a three-wire line cord with a suitable type of insulation and sufficient length.</p> <p>Use a three-prong plug that is appropriate for the AC input voltage.</p> <p><i>At this point, refer to the Pyramid Integrator Installation Manual, Pub. No. 5000-6.2.10, pages 9-4 and A-12.</i></p>
<p><i>Attach the other end of the line cord to the power supply's AC input connector.</i></p>	<p>Use the instructions and illustrations on pages 9-4 and A12.</p>



WARNING: Be certain to connect the ground wire to both the AC connector and the plug. Failure to do so could result in a dangerous electric shock to personnel.

NOTE: Do *not* apply AC power to the power supply yet.

Connecting CVIM System Components
(continued)

Your Action

Locate the DC voltage-selection switch on the CVIM module.

Comments

This is a slide switch near the connector edge of the CVIM module.

NOTE: No disassembly is required to access this switch.

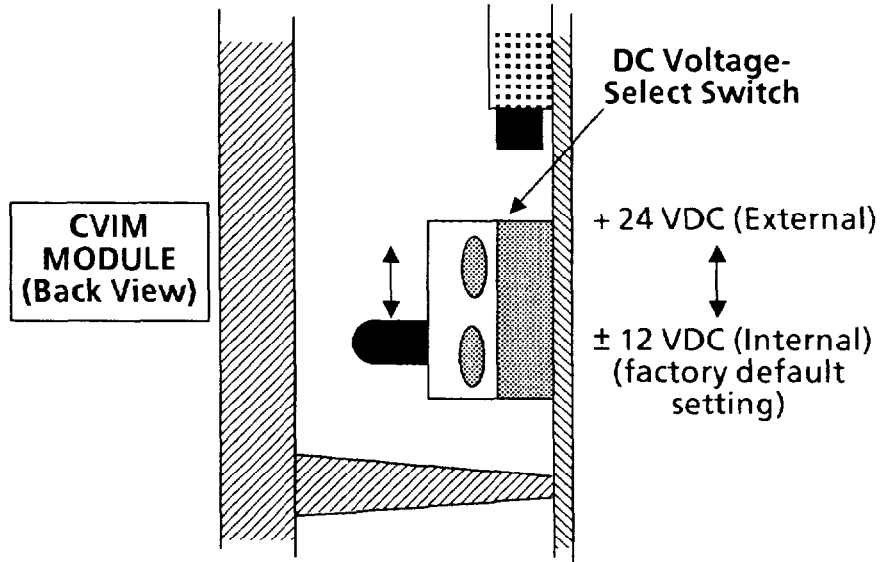

Determine whether your application requires an external 24VDC power supply.

The CVIM module uses a DC-to-DC converter to supply power to the cameras. The converter gets its DC voltage from either the chassis power supply ($\pm 12V$) or from an external DC power supply ($+ 24V$).

Your choice of DC power source should be based on whether the chassis power supply has sufficient capacity in its $+ 12V$ and $-12V$ sections for all the modules and cameras in your application.

The following table shows the current required for one CVIM module alone and with one and two cameras:

+ 12V Current Requirement	-12V Current Requirement	No. of Cameras
0.065A	0.075A	0
0.275A	0.285A	1
0.405A	0.415A	2

Connecting CVIM System Components

(continued)

Your Action	Comments
<i>Set the DC voltage-selection switch to match the DC voltage source.</i>	<p>To determine the <i>total</i> current load on the +12V and -12V sections of the chassis power supply, add the current requirements for all CVIM modules and cameras, then add to that the current requirements for all <i>other</i> modules (if any) in the same chassis.</p> <p>If the total current load exceeds the capacity of <i>either</i> the +12V or -12V section in the chassis power supply, you must use an external 24VDC power supply.</p> <p>If your application requires an external 24VDC power supply, here are the current requirements for a CVIM module with one and two cameras:</p> <ul style="list-style-type: none"> ● One CVIM module with <i>one</i> camera: 0.210A. ● One CVIM module with <i>two</i> cameras: 0.340A. <p>To determine the <i>total</i> current load on the 24V power supply, add the current requirements for all CVIM modules and cameras in the chassis. Obtain a 24V power supply that has sufficient capacity to meet the needs of your application.</p>
<i>Install the CVIM module in the chassis.</i>	<p>Set the switch to ± 12 when the camera power source is <i>internal</i> – the chassis power supply. Set the switch to +24 when the camera power source is <i>external</i> – a 24VDC power supply.</p> <p>Carefully align the CVIM module with any available slot in the chassis. Slide the module into the chassis and press down to seat the module.</p> <p>Finally, tighten the thumb screws evenly to secure the CVIM module.</p> <p>NOTE: Do <i>not</i> push in the DC PWR/LOCK handle yet.</p>
<i>Place the chassis upright on the work surface</i>	

Connecting CVIM System Components (continued)

Your Action

Refer to the CVIM interconnect diagram below for the cable connections in the next steps.

Comments

The CVIM interconnect diagram is similar to the one on the side of the CVIM module. It does not, however, show connections to the communication ports.

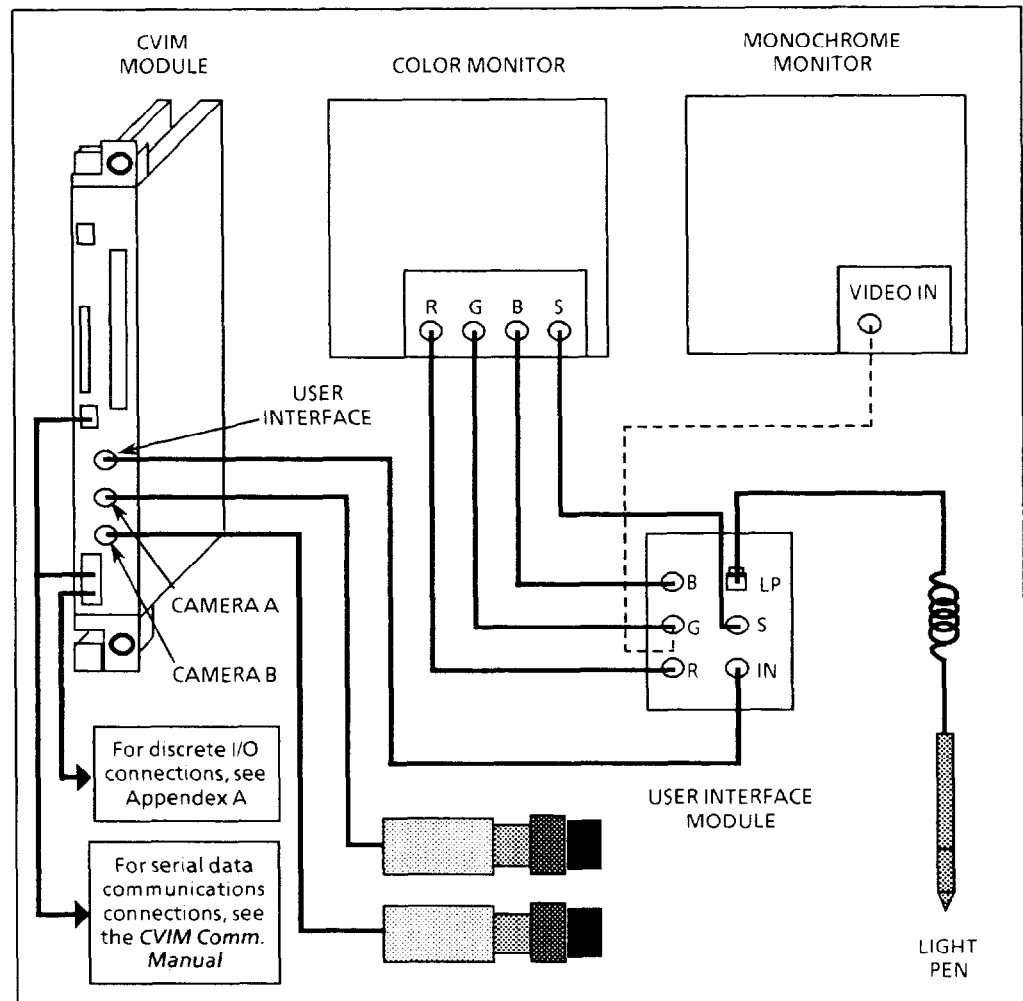

Locate the user interface cable.

The user interface cable is Cat. No. 2801-NC18A, -NC18B, or -NC18C. Note that the cable ends have *identical* connectors – they are both *female*.

NOTE: Be certain that you have the user interface cable, *not* the camera cable.

Connecting CVIM System Components (continued)

Your Action

Comments

The user interface cable has a label attached to each end:



Locate the user interface box.

The user interface box is Cat. No. 2801-N22. The connectors on the box are arranged as follows:

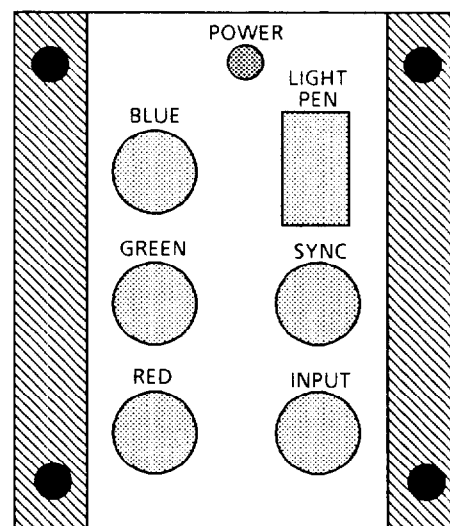

CAUTION: Attempting to connect the camera cable to the User Interface connector on the CVIM module can cause damage to the CVIM module circuitry.

Connect one end of the cable to the CVIM module.

Carefully align the cable connector with the User Interface port, then insert.

Connect the other end of the cable to the user interface box.

Carefully align the cable connector with the INPUT connector, then insert.

Locate a camera cable.

The camera cable is Cat. No. 2801-NC14, -NC15, or -NC16. Note that the cable ends do *not* have identical connectors – one is *female*, and the other is *male*.

Connect the male end of the cable to the CVIM module.

Carefully align the male connector with the Camera A or Camera B port, then insert.

Connecting CVIM System Components

(continued)

Your Action	Comments
Connect the <u>female</u> end of the cable to the camera.	
Place the video monitor on the work surface.	
Locate the coaxial cable(s) for the video monitor.	The coaxial cable is Catalog No 2801-NC2 or -NC3. A <i>color</i> monitor requires <i>four</i> cables; a <i>monochrome</i> monitor requires <i>one</i> cable.
	<i>If your monitor is <u>color</u>,</i>
Connect the coaxial cables to the color monitor.	Connect to the R, G, B, and EXT SYNC "IN" connectors. Set each terminator switch to OFF.
Connect the coaxial cables to the user interface box.	Connect the other end of each cable to the corresponding RED, GREEN, BLUE, and SYNC connector.
	<i>or, if your monitor is <u>monochrome</u>,</i>
Connect the coaxial cable to the monochrome monitor.	Connect to the VIDEO IN connector. Set the terminator switch to OFF.
Connect the coaxial cable to the user interface box.	Connect the other end of the cable to the GREEN connector.
Locate the light pen.	
Connect the light pen plug to the user interface box.	Connect to the LIGHT PEN jack.
	<i>For systems requiring a 24VDC power supply, follow the next several steps:</i>
Obtain an AC line cord for the 24VDC power supply.	Use a three-wire line cord with a suitable type of insulation and sufficient length.
Attach one end to a plug.	Use a three-prong plug that is appropriate for the AC input voltage.
Attach the other end to the 24VDC power supply.	Observe the markings on the power supply's AC input.



WARNING: Be certain to connect the ground wire to both the AC input and the plug. Failure to do so could result in a dangerous electric shock to personnel.

NOTE: Do not apply AC power to the 24VDC power supply yet.

Connecting CVIM System Components

(continued)

Your Action	Comments
Locate the DC power cable for the external power supply.	The power supply cable will be either Cat. No 5120-CP2 or 5120-CP3. Each has a set of color-coded wires and a right-angle molded plug.
Connect the <u>red</u> wires to the power supply output.	If your power supply has a "+ Sense" terminal, connect the <i>single</i> red wire to that terminal. Connect the <i>triple</i> red wire to the other "+ Output" terminal. If your power supply does <i>not</i> have a "+ Sense" terminal, connect <i>both</i> red wires to the "+ Output" terminal.
Connect the <u>black</u> wires to the power supply output.	If your power supply has a "-Sense" terminal, connect the <i>single</i> black wire to that terminal. Connect the <i>triple</i> black wire to the other "-Output" terminal. If your power supply does <i>not</i> have a "-Sense" terminal, connect <i>both</i> black wires to the "-Output" terminal.
Connect the molded plug to the chassis power supply.	The molded plug is <i>polarized</i> . Align the plug carefully with the + 24V Input jack on the front panel of the chassis power supply, then push the plug in until it latches in the jack. This completes the component connections for the powerup check. Now, continue with the powerup check.

Powering Up CVIM System

Your Action	Comment
Prepare the video monitor for powerup.	At this point, with all basic components connected together, the CVIM system is ready for the powerup check. Set the monitor brightness and contrast controls to the middle of their range. Set the scan mode switch to "UNDER." Set the power switch to OFF.
Insert the video monitor line cord plug in the AC outlet. Set the video monitor power switch to ON.	 <p>CAUTION: Verify that the AC voltage source is within limits for both the video monitor and the CVIM system.</p> <p>After a few seconds, the raster should be dimly visible on the monitor screen. If you're not sure, increase the screen brightness to <i>maximum</i> for a moment, then return it to its midrange setting.</p>

Powering Up CVIM System *(continued)*

Your Action

Comment

Insert the CVIM system line cord plug in the AC outlet.

If your CVIM system is using a +24VDC power supply, insert the line cord plug in the AC outlet.

Push in the DC/PWR LOCK handle.

Be sure the lock handle is in as far as possible. The power/lock mechanism connects DC power to the modules and locks them in the chassis. It also prevents anyone from removing a module with DC power applied.

On the power supply front panel, the DC light should turn on.

On the CVIM module front panel, the red Memory Active and green Trigger 1 lights will be *on* briefly. The Pass/Fail light should be a steady green.

After about 15 seconds, the Memory Active and Trigger 1 lights should be *off*, but the Pass/Fail light should still be green. If so, the powerup sequence was successful.

Assuming the powerup sequence was successful, the monitor screen will display the "banner" message, the test pattern, and several "menu boxes":

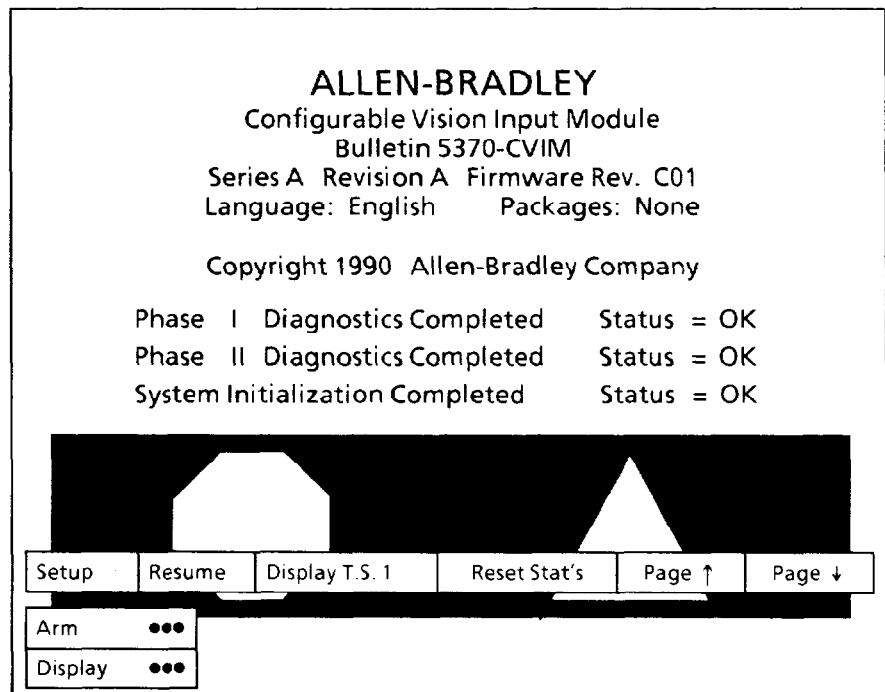

Powering Up CVIM System *(continued)*

Your Action

Comment

If the Pass/Fail light turns red, the powerup sequence was *not* successful. In addition, a failure message may appear on the monitor screen. If these conditions appear, a malfunction has occurred during the powerup sequence. Pull out the DC/PWR LOCK handle and remove the AC power plug, then check the cable connections and re-seat the power supply and CVIM modules. Try the powerup sequence again.

If the system repeatedly fails to complete the powerup sequence successfully, record all messages appearing on the monitor screen, then contact your Allen-Bradley Representative.

Use the following steps to perform a simple test of the CVIM "user interface."

Aim the light pen at the menu box labeled Setup.

Move the pen around slightly until a red border appears around the Setup menu box.

Press the light pen tip against the Setup menu box.

When you press the light pen tip against the menu box ("pick" the box), the banner message and the original set of menu boxes will disappear, and the "Main Configuration menu" will appear. This indicates that the CVIM system has entered the "setup" or *configuration* mode.

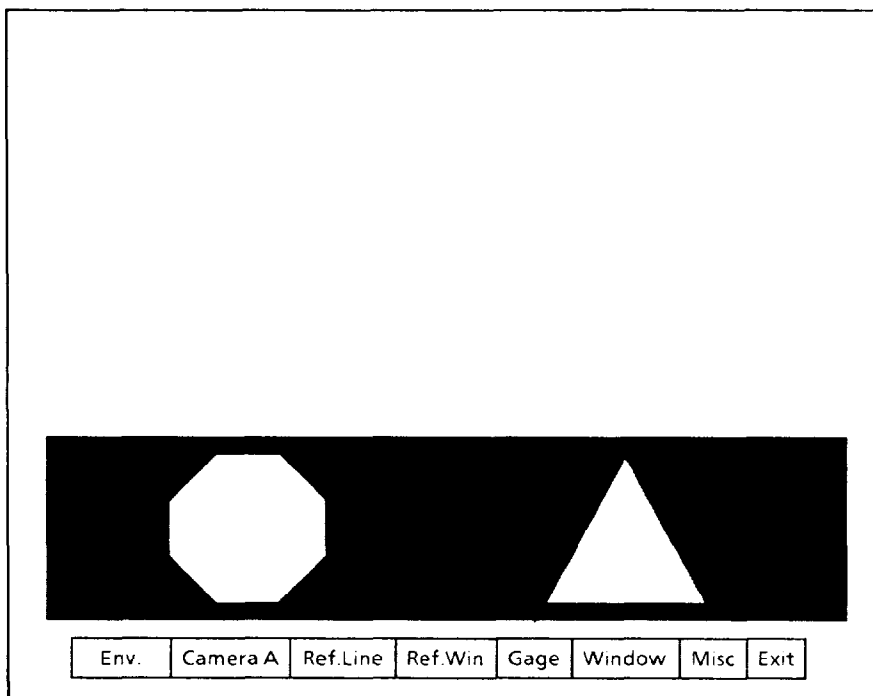

If the user interface appears to be OK, the CVIM system is now ready for use.

Powering Up CVIM System (continued)

At this point, you should refer to the *CVIM Quick Start Self-Training Guide*, Catalog No. 5370-ND003, and familiarize yourself with the CVIM user interface. When you complete that manual, and you are comfortable with the user interface, you should be ready to investigate the configuration procedures described in this manual.

If you have not yet installed the CVIM system at its factory-floor site, refer to the following Allen-Bradley manuals:

- Pyramid Installation Manual, Publication 5000-6.2.10.
- Grounding and Wiring Guidelines, Publication No. 1777-4.1.
- Solid State Control Safety Guidelines, Publication No. SGI-1.1.

These manuals contains all the information required for panel- or rack-mounting, electrical grounding, and connecting the I/O components.

You will have already performed in *this* chapter some of the steps described in the PI installation manual. When you encounter one of those steps, verify that you have performed it correctly, then continue.

Chapter 3 CVIM User Interface

Chapter Objective

The objective of this chapter is to acquaint you with the CVIM user interface – the means by which you set up the CVIM system to perform your vision application, operate the system, and monitor its operation.

CVIM User Interface

The term “CVIM user interface” refers to the specific devices that enable you to interact with the CVIM system.

The user interface consists of just two main parts:

1. A light pen.
2. Graphic figures on the video monitor screen.

You will use the user interface to configure the CVIM system for its inspection tasks and, during system operation, monitor the results of those inspections.

Figure 3.1 shows the light pen pointed at a graphic figure on the monitor screen.

Figure 3.1 CVIM Interface: Light Pen and Graphic Figures

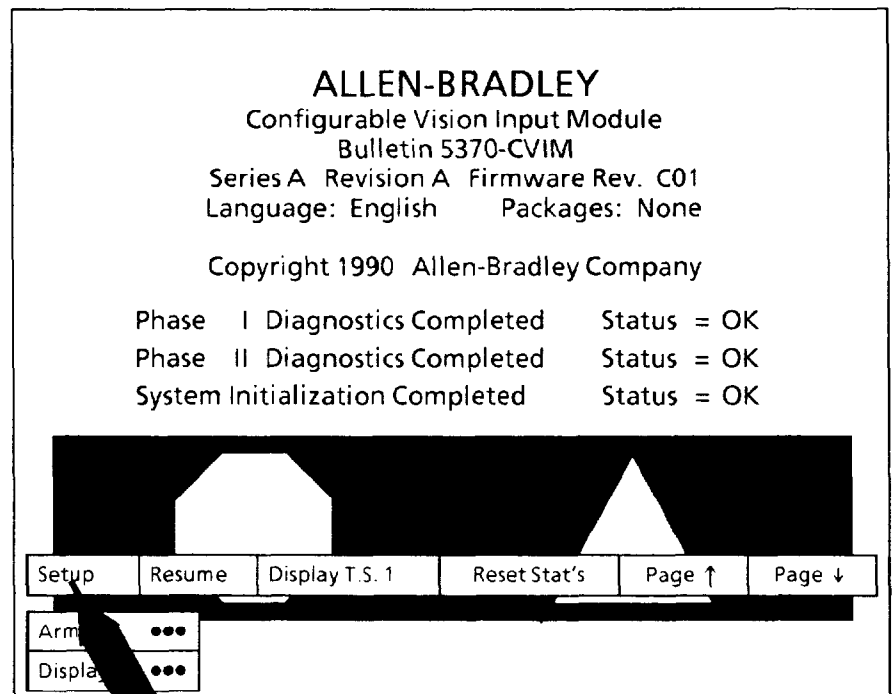

Notice that the user interface has *no keyboard*. To interact with the CVIM system, you just point the light pen at a graphic figure on the monitor screen and press the light pen tip against the figure.

Light Pen If you compare the CVIM user interface to a keyboard-driven system, the light pen is the equivalent of the cursor-control keys – it *points* to figures on the monitor screen so that you can select some kind of operation or function.

When you point the light pen at a graphic figure (a popup menu or a symbol) on the monitor screen, the light pen “sees” that figure through a hole in its tip. When you then press the light pen tip against the figure, the CVIM system selects or “picks” the figure. Your next step would depend on which graphic figure you selected.

The light pen’s main functions are selecting menu boxes and manipulating symbols. Performing these functions involves several *specific* actions, as follows:

- Pointing and highlighting.
 - Picking.
 - Dragging.
 - Placing.
-

Pointing and Highlighting “Pointing” means aiming the light pen at a specific graphic figure (menu box or symbol) in order to “highlight” that figure.

A sensor in the light pen sees light through a hole in the light pen tip. When you point the light pen directly at a graphic figure, the CVIM system will respond by “highlighting” the figure, indicating that the sensor sees it.

You will know the figure is highlighted when some part of it changes to a brighter color; however, when pointing at a small figure, you may need to move the light pen around a bit before the figure will be highlighted.

Your next step is “picking” the highlighted figure.

Picking “Picking” means pressing the light pen tip against a highlighted graphic figure in order to select the function that the figure represents.

Pressing the tip against the screen activates a switch. Signals from the light sensor and switch cause the CVIM system to “pick” the highlighted figure.

Picking (continued) The results of picking vary. Picking a menu box usually causes additional menus or tables to appear above or alongside the menu box. Picking a symbol usually enables “dragging” (moving) the symbol or changing its size. For symbols, your next step is “dragging” the picked symbol.

Dragging “Dragging” means moving a picked symbol to a different location on the screen, and/or changing the symbol’s size. (Dragging has no meaning for popup menus, since they are in fixed positions.)

You drag a symbol by first picking the symbol, then backing the light pen tip about a half inch from the screen – the sensor must still “see” the symbol. When you move the light pen across the screen, the symbol will follow.

Your next step is “placing” the dragged symbol.

Placing “Placing” means locking a symbol at its destination on the screen after dragging it there.

When you have dragged the symbol to its correct position, you simply press the light pen tip against the screen to lock the symbol at that position.

**Summary:
Manipulating Symbols** Point the light pen at a symbol until the symbol “highlights” (brightens or changes color), then press the light pen tip against the highlighted symbol to “pick” the symbol. Next, “drag” the entire symbol across the screen or change its size or shape, whichever is appropriate for that symbol. Finally, press the light pen tip against the screen to “place” (lock) the symbol in position.

Graphic Figures The CVIM system generates the graphic figures and superimposes them over the camera image on the monitor screen. Graphic figures are of three main types: Menus, tables, and symbols.

Menus consist of two or more rectangular boxes, arranged horizontally and vertically, with words and/or numbers inside. These words and numbers identify a particular configuration parameter, function, or operating mode. Menus always appear in specific positions in relation to other menus – they cannot be moved.

Tables contain mostly numeric values. Some are used for selecting parameters, and others display data resulting from inspections.

Symbols consist mainly of the various geometric shapes that represent the analysis tools and the devices that enable you to position the tools and set some of the tool parameters. During system configuration, you can set the size, shape, and position of these tools in relation to the screen image of the item to be inspected.

Menus Menus consist of boxes that appear both singly and in groups that are joined horizontally or vertically.

In Figure 3.2, the Run Mode menu (A) appears at the bottom of the monitor screen after the CVIM system completes its powerup cycle, and also during the system run mode.

The Main Configuration menu (B), appears at the bottom of the screen during system configuration.

Figure 3.2 Run Mode and Main Configuration Menus

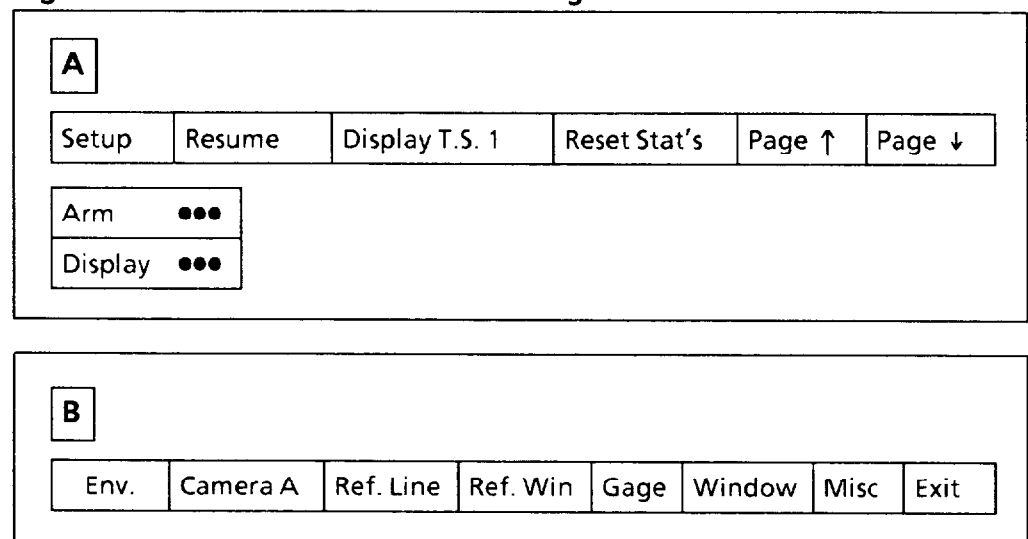

Menus (continued) Menu boxes that are joined vertically (except the two in the Runtime menu) are called “popup” menus because they “pop” up when you select one of the menu boxes in the Main Configuration menu (and also in many of the popup menus themselves).

Figure 3.3 shows an example of two popup menus above the Main Configuration menu.

Figure 3.3 Two Popup Menus

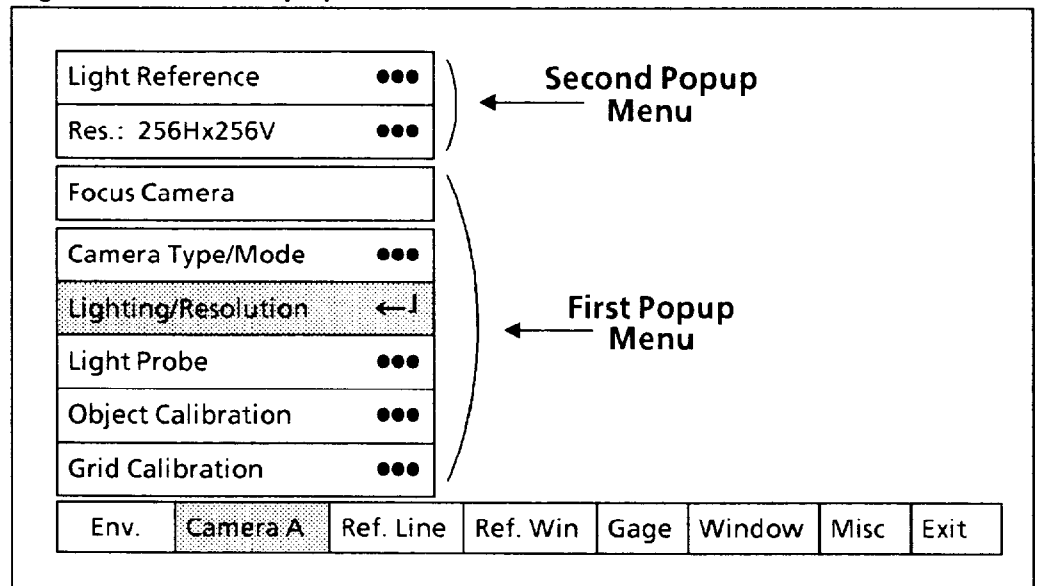

All menu boxes contain words, abbreviations, and/or numbers that identify their function. In the example above, these functions include:

- A Main Configuration menu configuration *category* (Camera A)
- A configuration *subject* (Lighting/Resolution, Calibration).
- A configuration *function* (Focus Camera, Light Reference).
- A configuration *parameter* (Res.: 256Hx256V).

Notice that some menu boxes contain three dots (•••). When you pick one of these boxes, one or more *additional* menus, or tables, will appear. At that same time, a carriage return symbol (←|) will replace the three dots, and the menu box’s background color will change to black. This indicates that if you pick the menu box again, it will return to its previous state, and the additional menu or table will disappear.

LOCKED MENU BOXES: You will occasionally see one or more menu boxes containing **black type**. The black type means that these menu boxes are disabled or “locked,” and you cannot pick them until some condition is met. The conditions vary considerably, but often involve enabling a tool or changing a tool parameter. In most cases the reason for the locked menu box will be evident from the immediate circumstances.

Menus (continued)

To select a configuration subject or parameter, or to perform a function, you must select or "pick" the proper menu box with the light pen. And you "pick" a menu box as follows.

Point the light pen at the menu box until the box perimeter "highlights" by turning red. Then, push the light pen tip against the highlighted box to "pick" the box. This starts the function or selects the configuration subject, whichever applies.

In Figure 3.3, you would first have picked the Camera A menu box, causing the *first* popup menu to appear. You would then have picked the Lighting/Resolution menu box, causing the *second* popup menu to appear.

Sometimes several "picks" are needed to reach a particular parameter-setting menu and change a parameter. In the Figure 3.3 example you would need to make *three* more picks to reach the Resolution menu (not shown) and change the camera resolution from 256Hx256V to, say, 512Hx256V.

Tables

Tables are of two main types: Those that are used to select configuration parameters, and those that display inspection results and statistics.

In Figure 3.4, table A is a configuration table. It is used during configuration to enter range limit values and assign output lines for the inspection tools.

Figure 3.4 Configuration and Statistics Tables

A			B	
	FAULT RANGE	WARNING RANGE		
High	575 ●●●	525 ●●●	Nominal	451
Low	350 ●●●	375 ●●●	Samples	1109
Output	1 ●●●	2 ●●●	Maximum	454
			Minimum	446
			Mean	450.804
			Std. Dev	1.140

Note that in table A the menu boxes contain three dots (●●●). When you pick one of these boxes, either another table or a "calculator pad" will appear. These enable you to select new values. At that same time, in the menu box a carriage return symbol (←J) will replace the three dots, and the box's background color will change to black.

Tables (continued) Table B in Figure 3.4 and Figure 3.5 are statistics tables. These tables display statistical values derived from the inspection "results" data for all enabled tools during a series of inspection cycles.

Figure 3.5 Inspection Statistics Table

PROBE	Samples	Mean	Std. Dev.	Min. Reading	Max. Reading
1.	123	50.000	55.000	59.187	61.000
GAGE	Samples	Mean	Std. Dev.	Min. Reading	Max. Reading
1.	123	37.287	1.348	36.413	39.293
2.	123	145.395	5.386	141.165	148.223
3.	123	0.768	0.0460	0.748	0.781
4.	123	6.000	0.000	6.000	6.000
5.					
6.					
WINDOW	Samples	Mean	Std. Dev.	Min. Reading	Max. Reading
1.	123	3245.245	32.399	3221.476	3278.243
2.	123	181.662	3.542	179.198	183.421
3.	123	11.000	0.000	11.000	11.000
4.					

Figure 3.6 is an inspection results table. This table displays the inspection "results" data for all enabled tools following each inspection cycle.

Figure 3.6 Inspection Results Table

TRIGGERS		FAULTS		Reference Lines / Windows			
Accepted:	123456	Master Fault:	123	1.	0	1.	0
Missed:	123	Light Probe:	34	2.		2.	
Total:	123579			3.		3.	
PROBE	Faults	Fail Low	Warn Low	Reading	Warn Hi	Fail Hi	
1.	0	50.000	55.000	59.187	61.000	63.000	
GAGE	Faults	Fail Low	Warn Low	Reading	Warn Hi	Fail Hi	
1.	0	130.000	140.000	150.187	160.000	170.000	
2.	12	25.000	28.000	32.354	34.000	37.000	
3.							
4.							
WINDOW	Faults	Fail Low	Warn Low	Reading	Warn Hi	Fail Hi	
1.	0	3000.000	3100.000	3214.485	3300.000	3400.000	
2.							
3.							

Symbols Symbols consist of lines, rectangles, and other geometric shapes that represent the analysis tools and the devices used to manipulate these tools and set some tool parameters.

Figure 3.7 shows the symbol for a linear gage, along with its manipulation "handles" and the "highlight square."

Figure 3.7 Symbols for Linear Gage and Handles

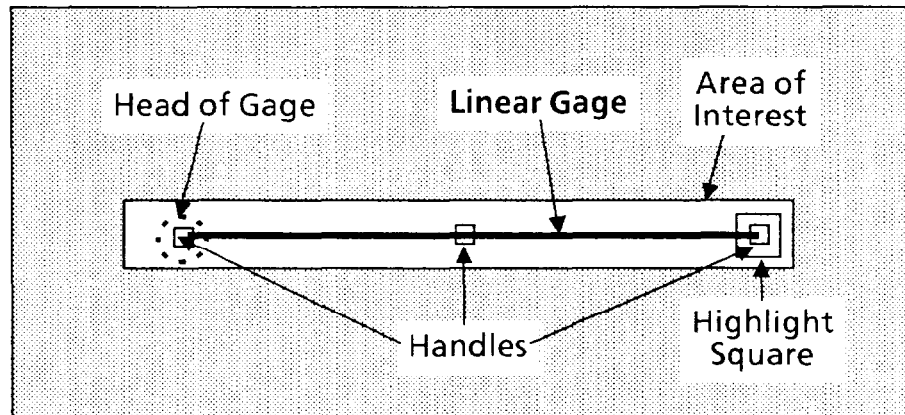

The dotted circle on the left is the "head" of the linear gage. The three small squares are the gage manipulation "handles." The white box around the gage is the "area of interest," which is the part of the image that the CVIM system evaluates during an inspection.

The "highlight square" appears as shown when you aim the light pen at a handle. This indicates that you can pick the handle and manipulate the gage.

To manipulate *any* tool, you must first pick the menu box(es) that cause the tool and its handles to appear on the screen. Then you highlight and pick one of the handles. When you do this, the handles and area of interest disappear, and a square "spotlight" appears where the highlighted handle was, as shown in Figure 3.8.

Figure 3.8 Linear Gage Ready for Manipulation

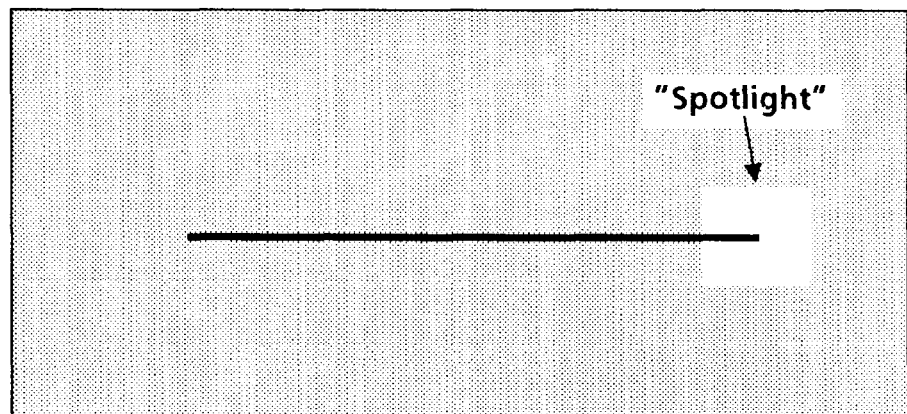

Symbols (continued) Figure 3.9 shows how the linear gage in Figure 3.8 might look if you dragged the right end of the gage to a new position. In this case, the right end of the gage moves, but the left end remains anchored.

Figure 3.9 Light Pen Manipulation of Gage Symbol

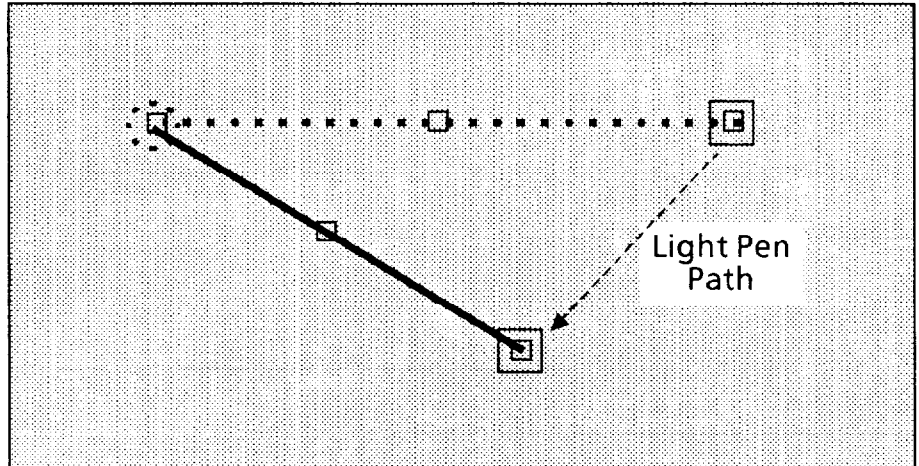

Configuration Shortcut

So far, you have seen how to access menus and manipulate symbols. But what about *exiting* a menu after you have completed parameter selection and/or symbol manipulation?

A key time-saving feature of the CVIM user interface is that it enables you to jump directly from wherever you are in a menu to any part of the same menu, or to another menu, or even to another configuration category in the Main Configuration menu.

You do *not* need to “back out” of *any* menu the way you entered it. This shortcut can save you considerable time getting around the screen.

Try this shortcut example:

Set up the menu with the two popup menus as shown in the following figure. To do this, pick the Camera (A or B) menu box. You should get the first popup menu. Then, pick the Lighting/Resolution menu box in the first popup menu. You should get the second popup menu.

Now, pick the Res.: 256Hx256V menu box in the second popup menu (the numbers might actually be 512Hx256V or 512Hx512V at this time – it doesn’t matter). A third popup menu should appear just above, and to the right of, the second popup menu. This is the Resolution popup menu. Your screen should now look like A in Figure 3.10.

Configuration Shortcut (continued)

Figure 3.10 Configuration Shortcut

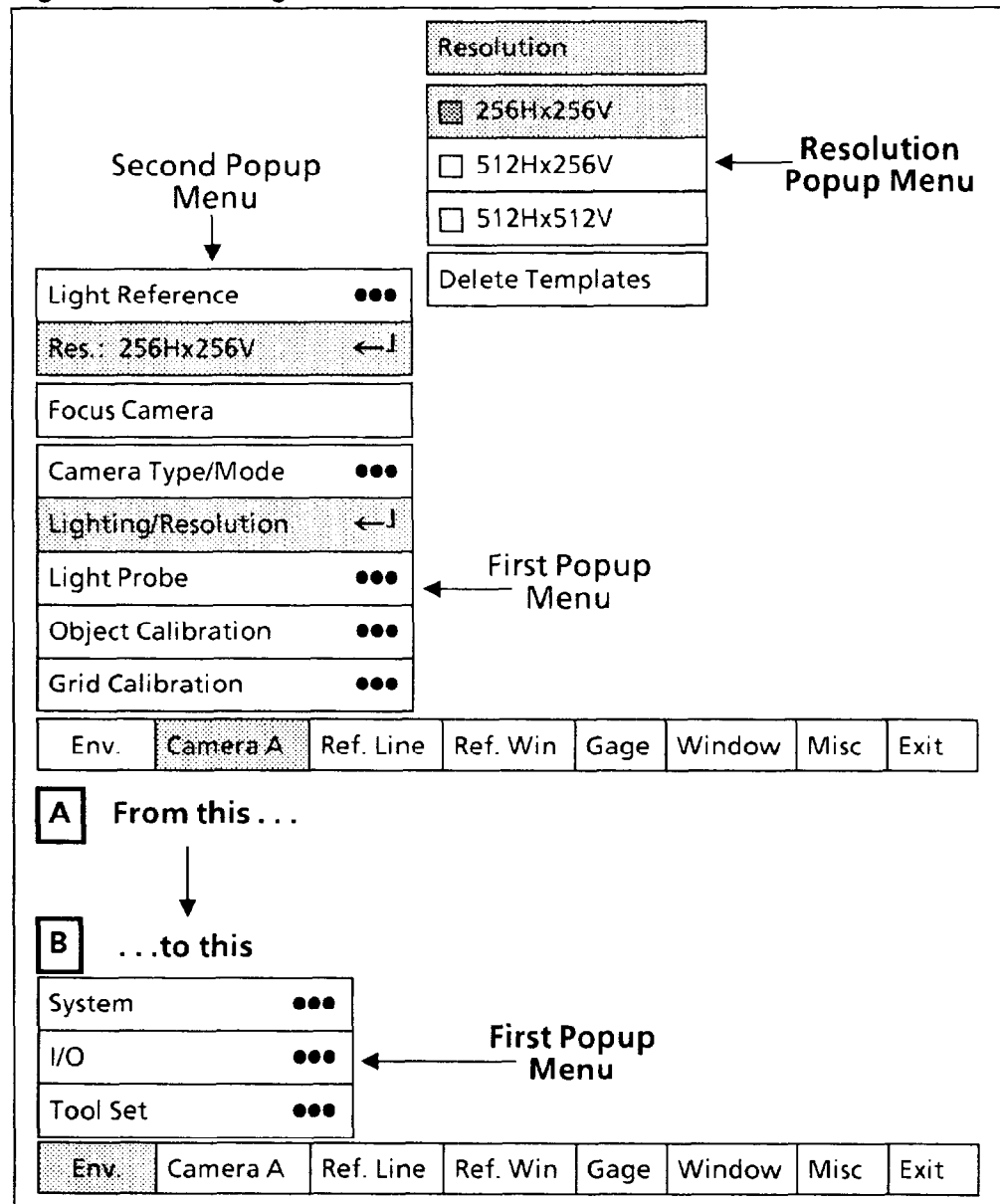

Here's the shortcut: Pick the Env. menu box in the Main Configuration menu. The three popup menus in A will disappear, and your screen will now display the *new* popup menu as shown in B. (All changes you may have made in A are saved.)

The point to remember is this: No matter where you are in a menu (whether you are finished with it or not), you can take a shortcut to the Main Configuration menu and pick a different configuration category.

Help Messages

By picking the *help message* symbol in the upper right corner of the monitor screen, you can have immediate access to a situation-related help message. No matter where you are in the configuration process, anytime you press this symbol . . .

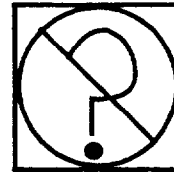

. . . a help message will appear in the box just to the left of the help message symbol, as follows:



The contents of each message will vary according to the last menu box you picked. If you pick a different menu box, the message relating to that box will appear.

Each help message provides a brief statement about the purpose of the related menu box. In some instances, X and Y coordinates, threshold levels, and other values will also appear within the message box.

Menu Removal Function

Since the popup menus share the monitor screen with the camera image, and necessarily *overlie* the camera image, at times these menus may obscure all or part of the image where you want to position your analysis tools.

The *menu removal function* enables you to make the menus "transparent," thus enabling you to see through them, or to remove them altogether from the monitor screen.

By repeatedly picking the *menu removal* symbol in the upper right corner of the monitor screen, you can make the menus "transparent," remove them from the screen altogether, and restore them to their original appearance. No matter where you are in the configuration process, anytime you pick this symbol. . .

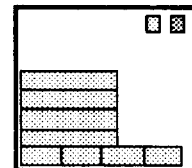

Menu Removal Function
(continued)

...the menus become "transparent," and the symbol changes to this:

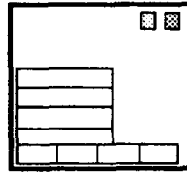

When you pick the symbol again, the menus disappear from the screen, and the symbol changes to this:

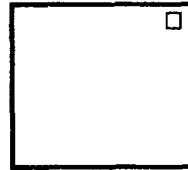

To *restore* the menus to their normal appearance, pick the symbol one more time. The popup menus and the menu removal symbol will return to their normal appearance.

Chapter 4 Operating Environment

Chapter Objective

The objective of this chapter is to show you how to configure the operating environment parameters in the Env. popup menu. This menu appears when you pick the Env. menu box in the Main Configuration menu.

For the most part, the operating environment parameters define the relationship of the CVIM module to the external devices with which it communicates. These parameters apply to the overall CVIM system, not just to specific tools.

Operating Environment

The *main* elements of the CVIM system operating environment are these:

- **Host selection.** Your CVIM system can operate in one of two modes: The stand-alone mode, or the hosted mode. You can specify which of these modes is appropriate for your application.
- **Video monitor.** Your system can use either a color or a monochrome video monitor. You can specify which one your system will be using.
- **Output lines.** The 14 discrete output lines carry signals that indicate the results of CVIM inspections, as well as various timing signals, to your process equipment. You can assign a specific signal function to each output line.
- **Data communication ports.** CVIM has two data communications ports: an RS-232 serial port, and a remote I/O port. If your application requires one or both of these ports, you will specify the data transmission rates and other parameters.
- **Trigger.** The trigger is the signal that begins an inspection cycle. You can select trigger sources for configuration ("setup") and for the run mode.
- **Strobe.** Two strobe outputs are available, one for each tool set. You can enable or disable these outputs.
- **Units.** If your application will use gages for making calibrated linear or circular measurements, you can select pixels, inches, or centimeters as the unit of measure.
- **Tool Sets.** A tool set consists of all of the analytical tools that CVIM can use to perform an inspection. Two identical tool sets are available, which you can apply to two separate tasks during each inspection cycle. You will select the appropriate combinations of tool set (1 or 2) and camera (A or B).

Configuring Operating Environment

This section shows you the procedures for configuring the operating environment parameters.

You will begin by picking the Env. menu box in the Main Configuration menu. You will then configure a variety of parameters grouped into three categories: System, I/O, and Tool Set.

Selecting Env. Popup Menu

Your first step is to select the Env. popup menu.

Your Action
Pick Env. in the Main Configuration menu.

Comments

When you pick the Env. menu box, the Env. popup menu appears above the Main Configuration menu, as follows:

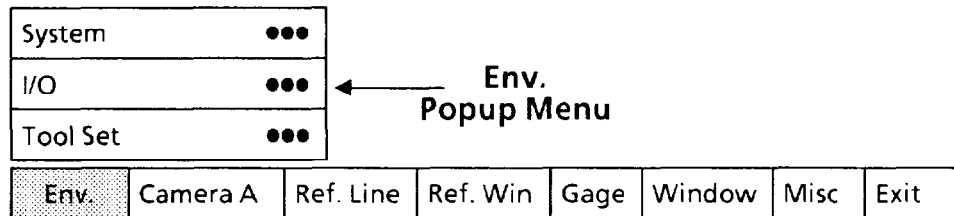

These are the three parameter categories in the Env. popup menu:

- **System:** Selects stand-alone or hosted mode, monitor type, tool display status, and gage measurement units.
- **I/O:** Assigns functions to the 14 discrete output lines, and sets operating parameters for RS-232 and remote I/O communications.
- **Tool Set:** Selects trigger source, active tool set and assigns cameras to tool sets.

In the following pages, the steps for configuring these parameters are presented in top-down order. You need not perform them in that order, however.

Selecting System Popup Menu and Parameters

Select the System popup menu, then select the parameters in that menu.

Your Action

Pick the System menu box in the Env. popup menu.

Comments

When you pick the System menu box, the System popup menu appears above the Env. menu, as follows:

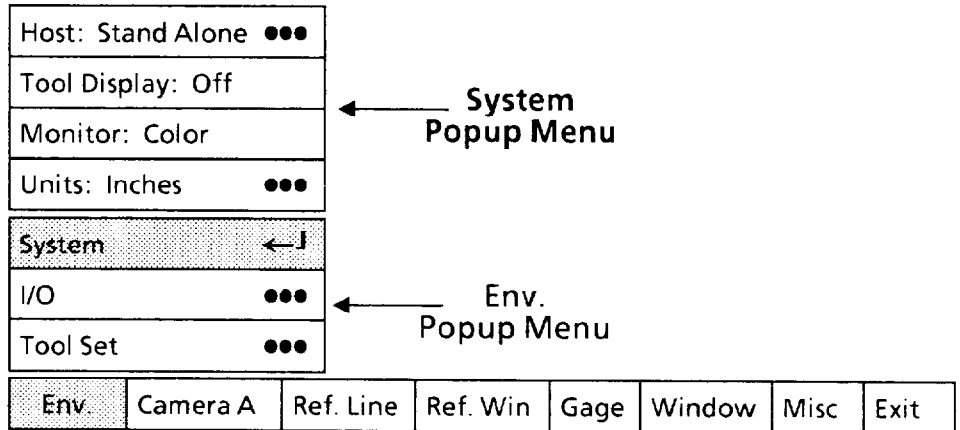

From the top down, these are the parameters in the System popup menu:

- **Host:** Selects the CVIM system operating mode. The mode can be Stand Alone, Pyramid, Remote I/O, or RS-232.
- **Tool Display:** During the tool configuration mode, it causes all enabled tools of one type, and within one tool set, to appear on the monitor screen when set to On. The tool display can be either On or Off.
- **Monitor:** Selects either a color or a monochrome video monitor. The monitor can be Color or Monochrome.
- **Units:** Selects the unit of measurement for linear or circular gages that perform calibrated linear measurements. The units can be Pixels, Inches, or CM (centimeters).

Selecting Host Select Popup Menu

Select the Host Select popup menu, then select the CVIM system operating mode from that menu.

The operating mode selection specifies whether your CVIM system will be configured for stand-alone or hosted operation.

Your Action

Look at the Host menu box in the System popup menu.

Comments

The Host menu box displays the currently selected CVIM system operating mode. The operating mode can be Stand Alone, Pyramid, Remote I/O, or RS-232.

Selecting System Popup Menu and Parameters (continued)

Selecting Host Select Popup Menu (continued)

Your Action

Pick the Host menu box.

Comments

When you pick the Host menu box, the Host Select popup menu appears alongside the System popup menu, as follows:

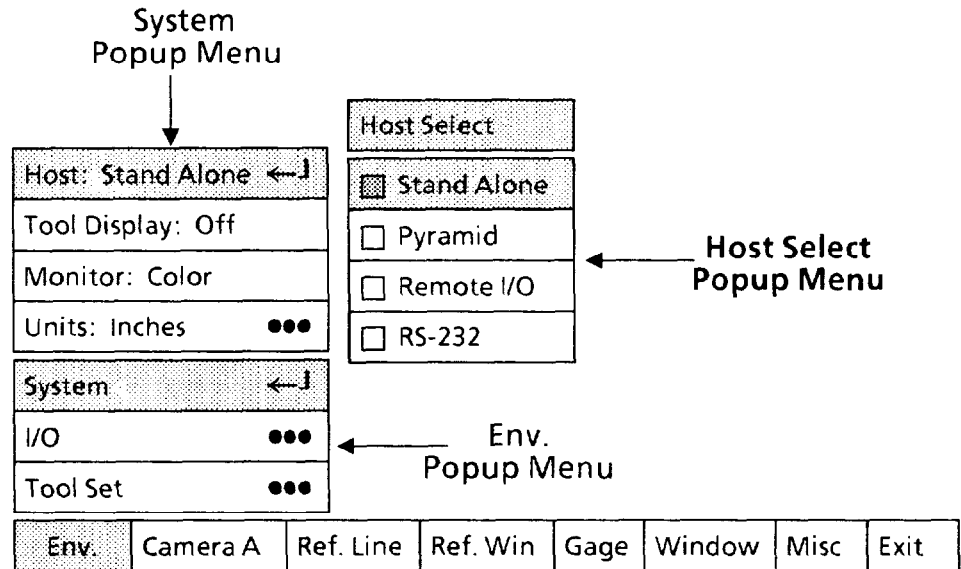

Note that the Stand Alone box in the Host Select menu has a shaded square () This indicates that Stand Alone is the currently selected operating mode. Chapter 1, *Introduction: CVIM Machine Vision*, differentiates the stand-alone and hosted operating modes.

Here is a brief description of each box in the Host Select menu:

- **Stand Alone:** Selects the stand-alone operating mode. In this mode, the CVIM system is controlled solely through the discrete I/O lines connected to the production equipment.

If a host system is connected to the CVIM system, and the CVIM system is configured for stand-alone operation, the host system can *only* read inspection results from the CVIM system.

- **Pyramid:** Selects the hosted operating mode. In this mode, the CVIM system can be controlled by Pyramid system modules occupying the same chassis.

- **Remote I/O:** Selects the hosted operating mode. In this mode, the CVIM system can be controlled by a remote PLC system (or an Allen-Bradley 6008 scanner card installed in a computer) connected to the CVIM module's remote I/O port.

- **RS-232:** Selects the hosted operating mode. In this mode, the CVIM system can be controlled by computer equipment connected to the CVIM module's RS-232 port.

Selecting System Popup Menu and Parameters (continued)

Selecting Host Select Popup Menu (continued)

Your Action

Pick the appropriate box in the Host Select popup menu.

Comments

The selection you make depends on the requirements of your particular application of the CVIM system.

Note that if you pick a *different* operating mode, the new selection will be highlighted in the Host Select popup menu and will also appear in the Host menu box.

Note also that if you change to the Pyramid operating mode, you must power the CVIM system down, then back up again, in order for the Pyramid system to recognize the CVIM system. *Before powering down, be sure to save the current configuration first, if appropriate.*

Selecting Tool Display Status

Select the *on* or *off* status for the tool display during the tool configuration mode.

When the tool display is *on*, all tools in the currently selected tool category will appear on the monitor screen.

For example, assume that you are currently configuring gage #4 and that you have already configured and *enabled* gages #1 through #3. If the tool display were *on*, gage #4 would be *red* and gages #1 through #3 would be *green*.

When the tool display is *off*, only the tool that you are currently configuring appears on the monitor screen. In the example above, you would see only gage #4.

Your Action

Look at the Tool Display menu box in the System popup menu.

Pick the Tool Display box, if appropriate.

Comments

The Tool Display menu box displays the currently selected tool display status. The tool display will be either On or Off.

When you pick the Tool Display box, the status will *toggle* to the opposite condition. Thus, On will change to Off, or vice versa.

Selecting Monitor Type

Select *color* or *monochrome*, whichever is appropriate for the type of monitor you are using.

NOTE: If you are using a monochrome monitor and the monitor type is set to *color*, the highlighting that appears in and around the menu boxes when you point the light pen at them will be very difficult to see.

Selecting System Popup Menu and Parameters (continued)

Selecting Monitor Type (continued)

Your Action	Comments
Look at the Monitor menu box in the System popup menu.	The Monitor menu box displays the currently selected monitor type. The monitor will be either Color or Monochrome.
Pick the Monitor menu box, if appropriate.	When you pick the Monitor box, the monitor type will toggle to the opposite type. Thus, Monochrome will change to Color, or vice versa.

Selecting Units Popup Menu

If your application will be using linear or circular gages to make calibrated linear measurements, select Pixels, Inches, or CM (centimeters) as the unit of measurement. Note that you will also need to perform one of the calibration procedures described in Chapter 5.

If your application will *not* need "units," you can skip this procedure.

Your Action	Comments
Look at the Units menu box in the System popup menu.	The Units menu box displays the currently selected unit for calibrated measurements. The unit will be Pixels, Inches, or CM (centimeters).
Pick the Units menu box, if appropriate.	When you pick the Units menu box, the Units popup menu will appear alongside the System popup menu, as follows:

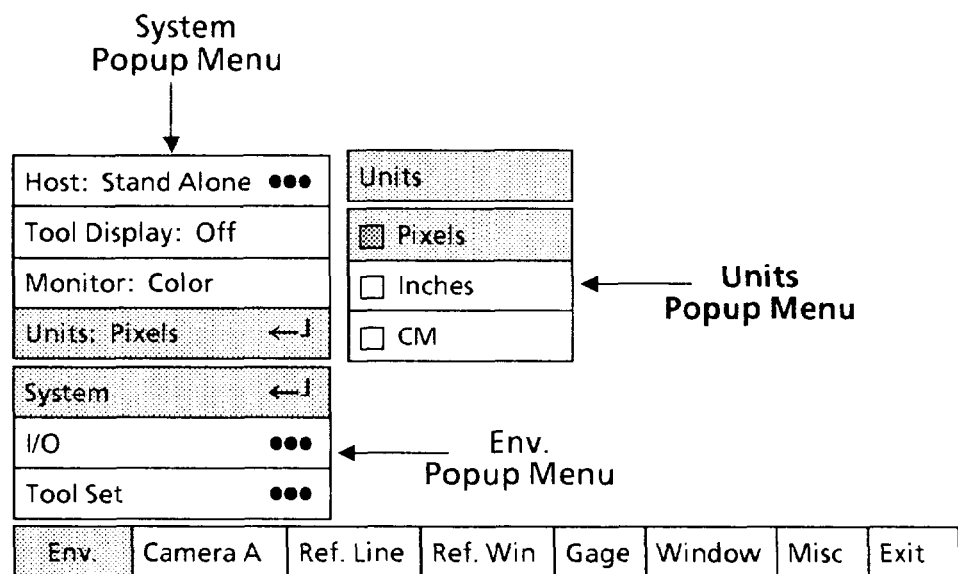

Note that the Pixels box in the Units menu has a shaded square () This indicates that Pixels the currently selected measurement unit.

Selecting System Popup Menu and Parameters
(continued)

Selecting Units Popup Menu (continued)

Your Action

Comments

Pick the appropriate box in the Units popup menu.

The selection you make depends on the requirements of your particular application of the CVIM system.

Note that if you pick a *different* unit, the new selection will be highlighted in the Units popup menu and will also appear in the Units menu box.

Selecting I/O Popup Menu and Parameters

Select the I/O popup menu then select the parameters in that menu.

Your Action

Comments

Pick the I/O menu box in the Env. popup menu.

When you pick the I/O menu box, the I/O popup menu appears above the Env. menu, as follows:

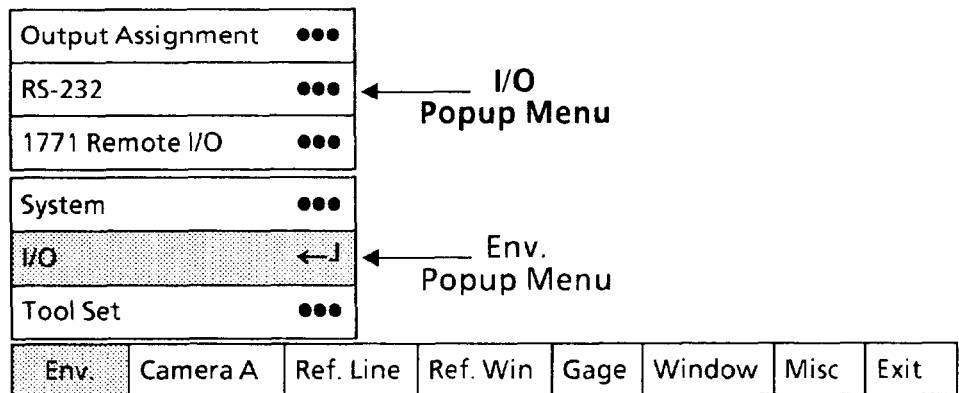

From the top down, these are the parameters in the System popup menu:

- **Output Assignment:** Selects the specific signal function for each of the 14 discrete output lines. Also, selects the pulse duration for the Results, Data Valid, and Master Range signals.
- **RS-232:** Selects the protocol and baud rate parameters for the RS-232 port.
- **1771 Remote I/O:** Selects the data rate and rack address parameters for the node adapter.

Selecting I/O Popup Menu and Parameters
(continued)

Selecting Output Assignment Popup Menu

Select the popup menu, then select the appropriate signal function for each output line that your application requires.

Your Action

Comments

Pick the Output Assignment menu box in the I/O popup menu.

When you pick the Output Assignment menu box, the Output Assignment popup menu appears alongside the I/O popup menu, as follows:

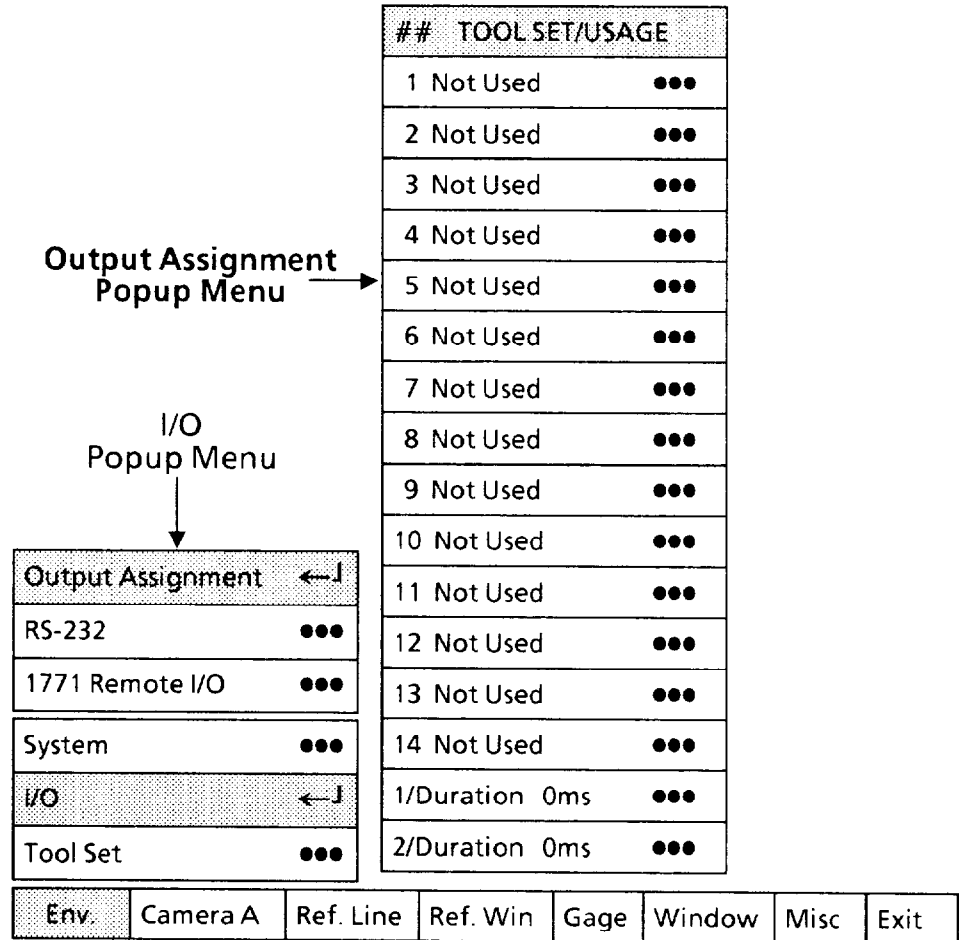

The Output Assignment popup menu consists of 16 boxes – 14 boxes for output line function assignments and two boxes for pulse duration settings.

Initially, the 14 function boxes will read “Not Used” and the two pulse duration boxes will read “0ms,” as shown in the example menu above. If the boxes had been previously configured, and the configuration stored, it would display whatever functions were assigned at that time.

NOTE: If a function box displays “1/Results” or “2/Results” in **black** type, it means that at least *one* analysis tool is already assigned to the output line designated by that function box. To *change* the function for that output line, you must first remove all tool assignments to it.

Selecting I/O Popup Menu and Parameters
(continued)

Assigning Output Line Functions

At this point, you should refer to the Output Line Planning Sheet in Appendix A, *Planning Discrete I/O Assignments and Connections*. This sheet will show you the function for each output line to be used in your application.

If you have *not* prepared this sheet yet, you should do so at this time.

If you have already prepared this sheet, you can now enter the output line functions as described in the following steps.

Your Action

Look at the first function box in the Output Assignment popup menu.

Pick the first function box.

Comments

This box indicates the currently assigned function for output line #1. In the Output Assignment menu shown above, the current assignment is "Not Used." This indicates that *no* function has been assigned to output line #1.

When you pick this box, the Output Line Function popup menu will appear alongside the Output Assignment popup menu, as follows:

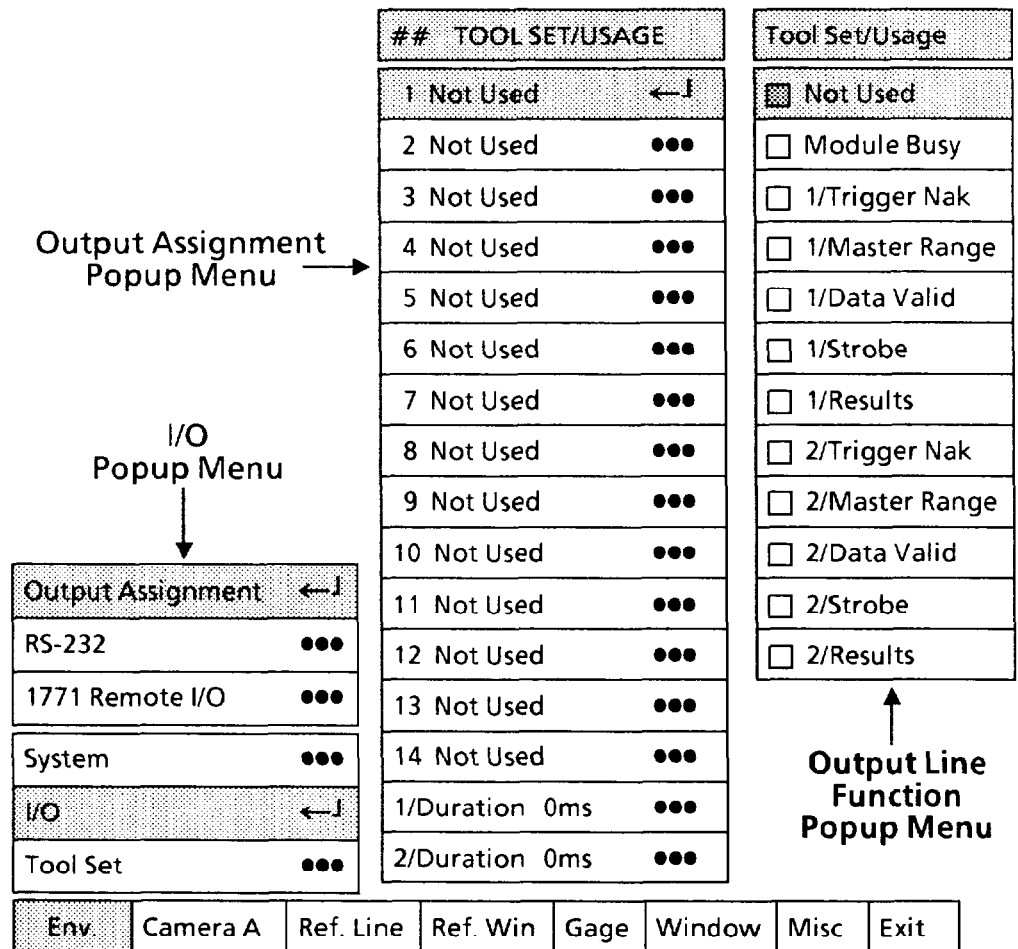

**Selecting I/O Popup Menu
and Parameters
(continued)**

Assigning Output Line Functions (continued)

Your Action	Comments
<i>Pick a function for output line #1, if appropriate.</i>	<p>Note that the Not Used box in the Output Line Function menu has a shaded square (◻) This indicates that Not Used the currently assigned function for output line #1.</p> <p>Refer to your Output Line Planning Sheet from Appendix A, and pick the appropriate function box in the Output Line Function menu for output line #1.</p> <p>Note that if you pick a <i>different</i> function than the current one, the new function will be highlighted in the Output Line Function menu and will also appear in the Output Assignment menu.</p>
<i>Pick the functions for the remaining output lines.</i>	<p>Refer to your Output Line Planning Sheet and assign the appropriate functions to the remaining output lines.</p> <p>NOTE: Be certain to assign "Not Used" to all output lines that are <i>not</i> to be used in your application. This ensures that no signals will be present on the unused lines.</p>
<i>Look at the two "Duration" boxes in the Output Assignment menu.</i>	<p>The two boxes display the currently selected pulse duration for the Results, Data Valid, and Master Range signals for the two tool sets.</p> <p>The pulse duration is stated in milliseconds, and the acceptable range is 1 to 2000 milliseconds.</p> <p>NOTE: If you specify 0 (zero) milliseconds, the signals will be latched. They will be <i>updated</i> at the completion of the next inspection cycle.</p>

Selecting I/O Popup Menu and Parameters (continued)

Assigning Output Line Functions (continued)

Your Action

Pick the 1/Duration box to set the pulse duration for tool set #1 signals.

Comments

When you pick the 1/Duration box, the "calculator" pad will appear alongside the Output Assignment popup menu, as follows:

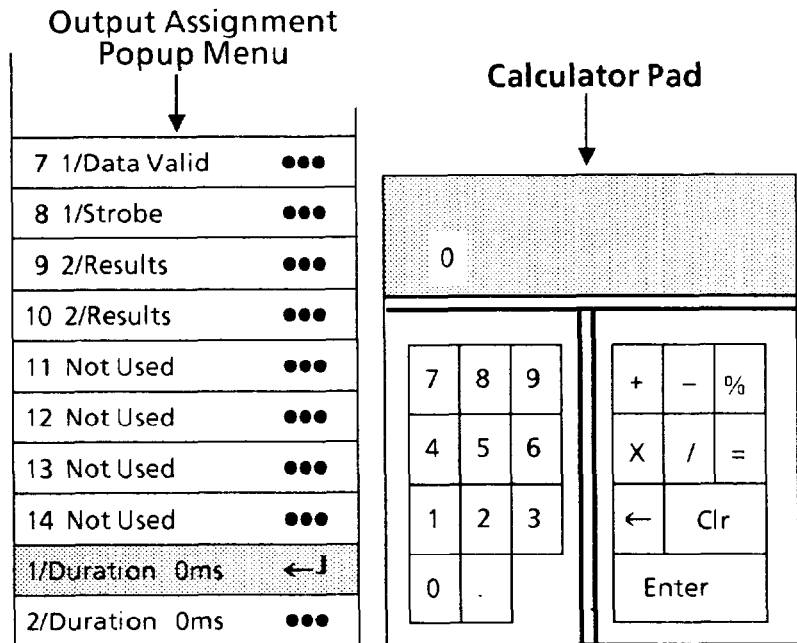

On the calculator pad, pick the appropriate pulse duration for tool set #1 signals.

Refer to the *I/O Parameters* table in Appendix B for the pulse duration you selected for tool set #1 signals. When you pick the new pulse duration number, it will appear in the calculator "display."

Pick the Enter key on the calculator pad.

When you pick the Enter key, the number you entered will appear in the 1/Duration box.

If appropriate, repeat the same process to set the pulse duration for tool set #2 signals.

Before you connect the CVIM I/O lines to your production equipment, read this warning.



WARNING: The CVIM local I/O lines will be disabled whenever hardware or software faults occur in the CVIM module and/or other modules in the Pyramid Integrator chassis. Failure to accommodate this logic convention when you interface the CVIM I/O lines to your production equipment may cause unintended operation of your equipment, which may result in serious personal injury or death.

Selecting I/O Popup Menu and Parameters
(continued)

Selecting RS-232 Parameters

If your application will be using the RS-232 port for data communication, you must select the appropriate RS-232 parameters.

For additional information on CVIM data communications, refer to the *CVIM Communications Manual*, Catalog No. 5370-ND002.

Your Action

Pick the RS-232 menu box in the I/O popup menu.

Comments

When you pick this box, the RS-232 popup menus appear alongside the I/O popup menu, as follows:

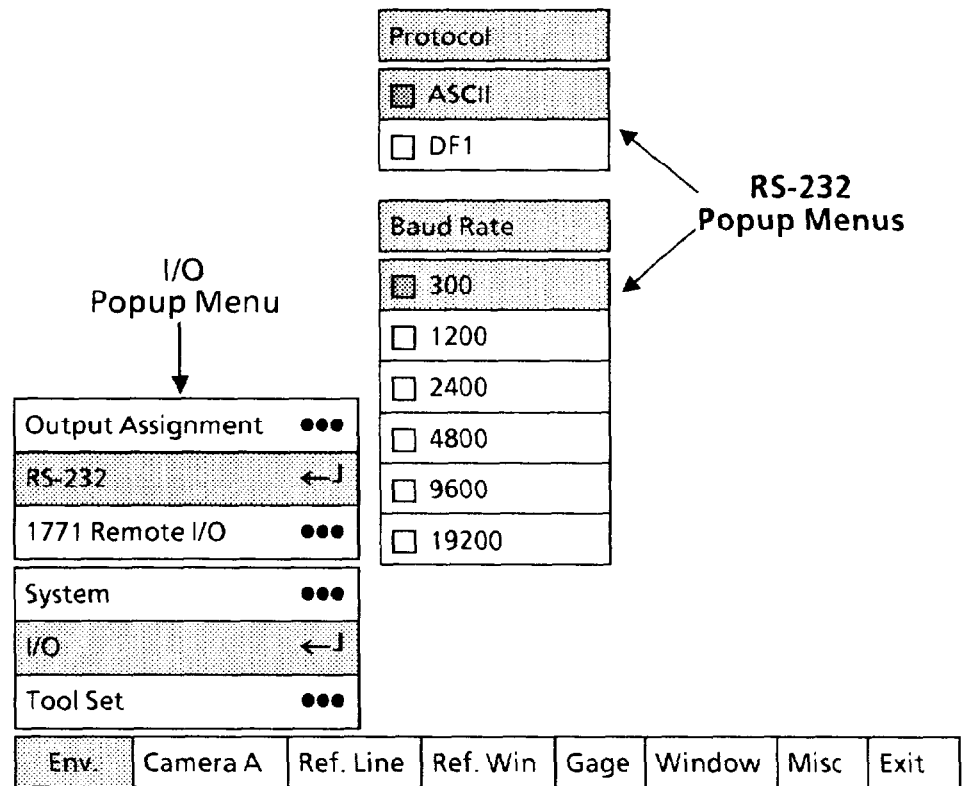

Note that the ASCII box in the Protocol menu and the 300 box in the Baud Rate menu has a shaded square (☑). This indicates that the RS-232 port is currently configured to use ASCII data communications protocol at 300 baud.

In the Protocol popup menu, the selections indicate the two RS-232 data communications protocols available with the CVIM system.

- ASCII - This indicates that the CVIM system uses standard ASCII characters for data communications through the RS-232 port.
- DF1 - This indicates that the CVIM system uses the Allen-Bradley DF1 protocol for data communications through the RS-232 port.

Selecting I/O Popup Menu and Parameters
(continued)

Selecting RS-232 Parameters (continued)

Your Action

Comments

Pick the appropriate protocol in the Protocol menu.

Pick the appropriate baud rate in the Baud Rate menu.

Selecting 1771 Remote I/O Parameters

If your application will be using the remote I/O port for data communication, you must select the appropriate remote I/O parameters. For more information about CVIM data communications, refer to the *CVIM Communications Manual*, Catalog No. 5370-ND002.

Your Action

Comments

Pick the 1771 Remote I/O menu box in the I/O popup menu.

When you pick this box, the 1771 Remote I/O popup menus appear alongside the I/O popup menu, as follows:

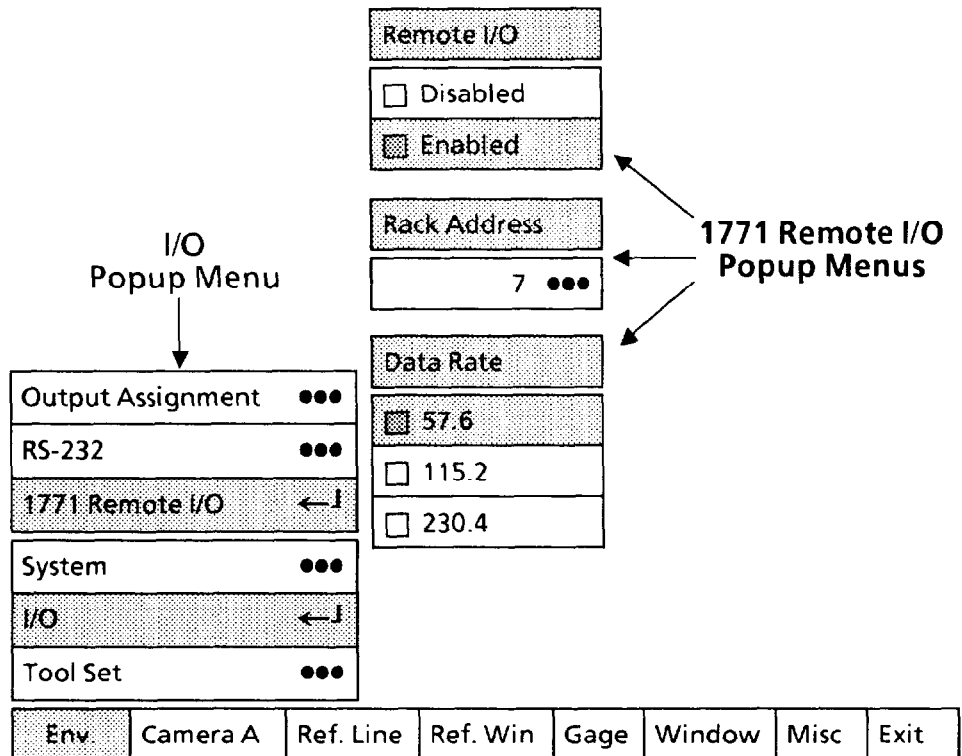

Note that the Enabled box in the Remote I/O menu and the 57.6 box in the Data Rate menu have a shaded square (☑). This indicates that the remote I/O port is currently enabled for data communications at 57.6K baud. Also, the number 7 in the Rack Address menu indicates the CVIM is currently selected as the 1771 rack address.

Selecting I/O Popup Menu and Parameters (continued)

Selecting 1771 Remote I/O Parameters (continued)

Your Action

Comments

Pick Enabled or Disabled in the Remote I/O menu.

Pick Enabled to enable using the remote I/O port. Otherwise, pick Disabled.

Pick the appropriate baud rate in the Data Rate menu.

Look at the address number in the Rack Address menu.

If the *current* rack address number is *correct*, skip the next step.

If appropriate, pick the menu box in the Rack Address menu.

When you pick the menu box, the "calculator" pad will appear alongside the 1771 Remote I/O popup menus, as follows:

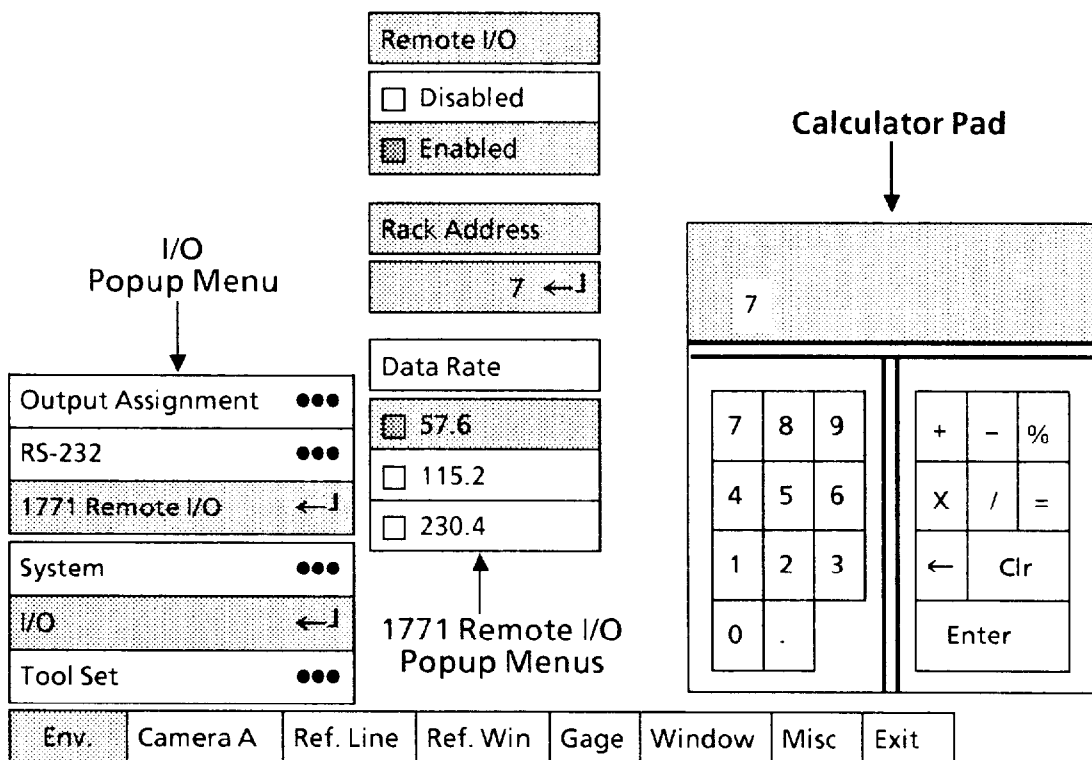

On the calculator pad, pick the appropriate rack address.

The new number will appear in the calculator "display." Note that the acceptable address numbers are 0 through 7.

Pick the Enter key on the calculator pad.

When you pick the Enter key, the new address will appear in the Rack Address menu.

Selecting Tool Set Popup Menu and Parameters

Select the Tool Set popup menu, then select the appropriate combination of cameras, tool sets, and trigger sources.

Your Action

Pick the Tool Set menu box in the Env. popup menu.

Comments

When you pick the Tool Set menu box, the three-part Tool Set popup menu will appear above the Env. popup menu, as follows:

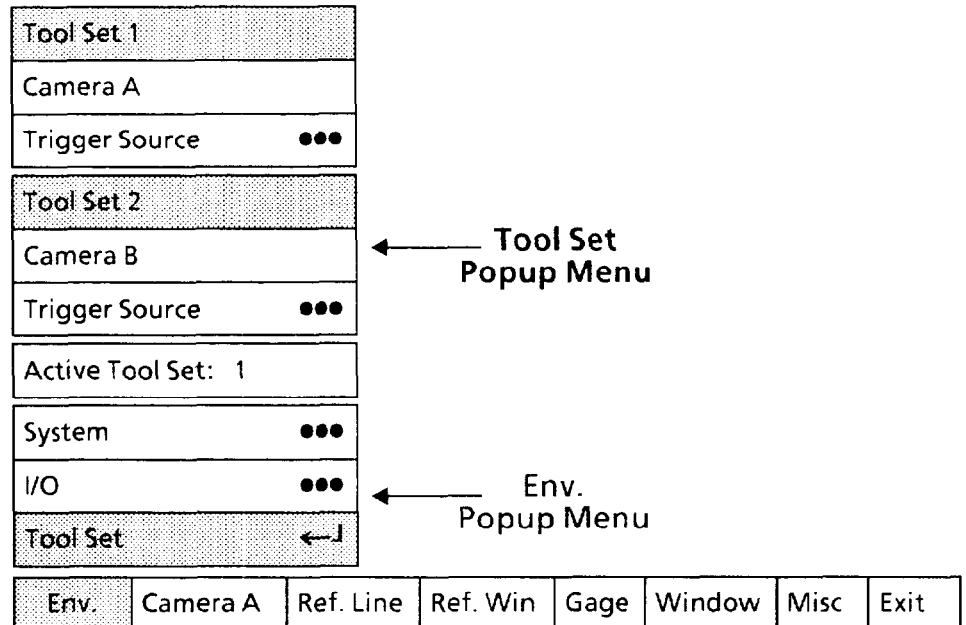

In the three-part Tool Set popup menu, the top two parts pertain to the camera and trigger source parameters for tool sets #1 and #2. The bottom part determines the active tool set number during configuration.

The three parts of the Tool Set menu have the following meanings:

- Tool Set 1 – In this part you can select either camera A or B as the image source for the tool set #1 analysis tools. In addition, you can select a tool set #1 trigger source for configuration and for runmode.
- Tool Set 2 – This is identical to Tool Set 1, except that it applies to tool set #2.
- Active Tool Set – In this part you can select the tool set and camera image that will appear on the monitor screen *during configuration*. The number will be either 1 or 2 for tool set #1 or tool set #2.

Selecting Tool Set Popup Menu and Parameters
(continued)

Selecting Tool Set #1 Camera and Trigger

Select camera A or B, then select the trigger source popup menus for tool set #1.

Your Action

Comments

Look at the Camera menu box under Tool Set 1.

This box indicates the currently selected camera (A or B) whose image will be used with tool set #1.

If appropriate, pick the Camera menu box.

When you pick the Camera menu box, the letter A will toggle to B, or vice versa. At the same time, the image on the monitor screen will change from one camera to the other, and a new image will be acquired.

Pick the Trigger Source menu box under Tool Set 1.

When you pick the Trigger Source menu box, the Runtime and Setup menus appear alongside the Tool Set popup menu, as follows:

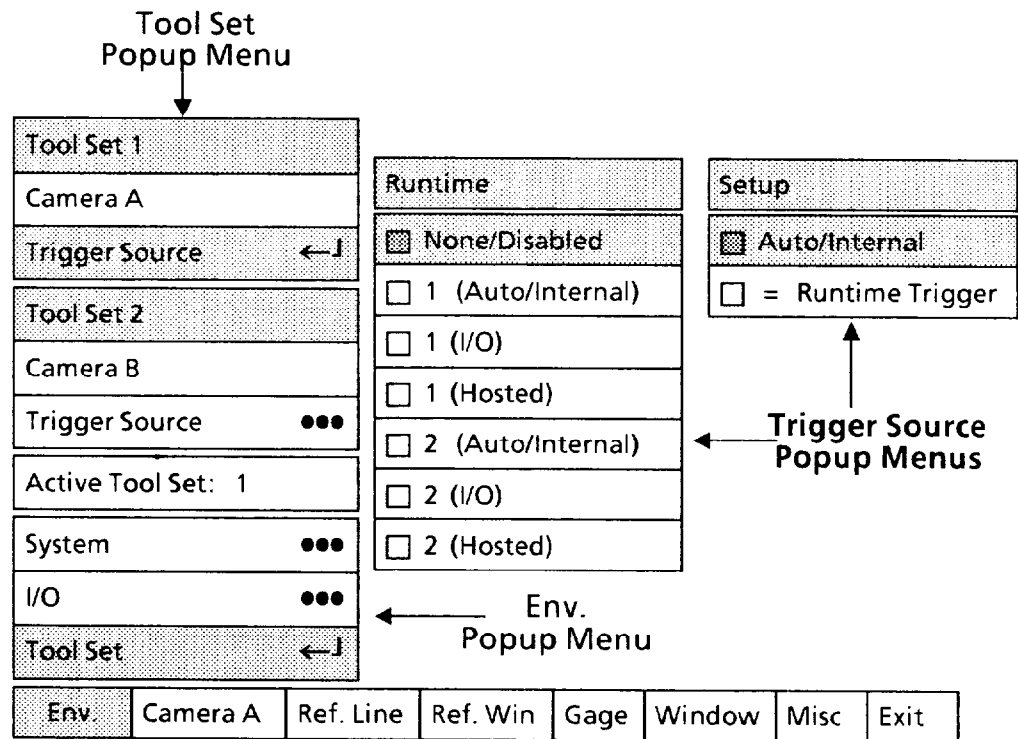

Note that the None/Disabled box in the Runtime menu and the Auto/Internal box in the Setup menu has a shaded square (☑). This indicates that the tool set #1 run mode currently has no trigger source enabled, and the configuration ("Setup") mode has the automatic internal trigger enabled.

Note also that the 2 (Auto/Internal), 2 (I/O), and 2 (Hosted) boxes are in black type, indicating that you cannot pick them at this time. (They will be enabled when you pick the Trigger Source menu box under Tool Set 2.)

Selecting Tool Set Popup
Menu and Parameters
(continued)

Selecting Tool Set #1 Camera and Trigger (continued)

Your Action

Comments

In the Runtime popup menu, the selections in the menu boxes have the following meanings:

- None/Disabled - This indicates that *no* trigger source will be enabled during the run mode.

- 1 (Auto/Internal) - This indicates that the trigger source for tool set #1 will be the CVIM module's internal circuitry. The trigger period will be one trigger pulse every 50 milliseconds, ± 5 . This is an approximate rate of 20 trigger pulses per second.

NOTE: If you select 1 (Auto/Internal) for tool set #1, you can *also* select 1 (Auto/Internal) for tool set #2.

- 1 (I/O) - This indicates that the trigger source will be the #1 trigger input through the CVIM module front panel.

NOTE: If you select 1 (I/O) for tool set #1, you can *also* select 1 (I/O) for tool set #2.

- 1 (Hosted) - This indicates that the trigger source will be the #1 host system trigger input through the backplane (Pyramid system), through the remote I/O port, or through the RS-232 port (computer system).

NOTE: If you select 1 (Hosted) for tool set #1, you can *also* select 1 (Hosted) for tool set #2.

- 2 (Auto/Internal), 2 (I/O), and 2 (Hosted) - These are in **black type**, indicating that you cannot select them at this time.

The selections in the Setup popup menu apply only during CVIM system *configuration*. They have the following meanings:

- Auto/Internal - This is the same trigger source described in 1 (Auto/Internal), above. When enabled, it ensures that a "live" camera image will appear on the monitor screen during the following functions: Focus Camera, Take Snapshot, Light Reference, Snap & Analyze, Continuous S&A, Snap & Register, and Continuous S&R.

- = Runtime Trigger - At various times during tool configuration, new camera images may be required to be *synchronized* with moving workpieces. By selecting the = Runtime Trigger box, you can use the *run mode I/O* trigger source to acquire synchronized images during *tool configuration*. In this case, the CVIM system will *wait* for the trigger signal to acquire each new image.

Selecting Tool Set Popup Menu and Parameters
(continued)

Selecting Tool Set #2 Camera and Trigger

If your application requires using tool set #2, select camera A or B, then select the trigger source popup menus for tool set #2.

Your Action

Comments

Look at the Camera menu box under Tool Set 1.

This box indicates the currently selected camera (A or B) whose image will be used with tool set #2.

If appropriate, pick the Camera menu box.

When you pick the Camera menu box, the letter A will toggle to B, or vice versa. At the same time, the image on the monitor screen will change from one camera to the other, and a new image will be acquired.

Pick the Trigger Source menu box under Tool Set 2.

When you pick the Trigger Source menu box, the Runtime and Setup menus appear alongside the Tool Set popup menu, as follows:

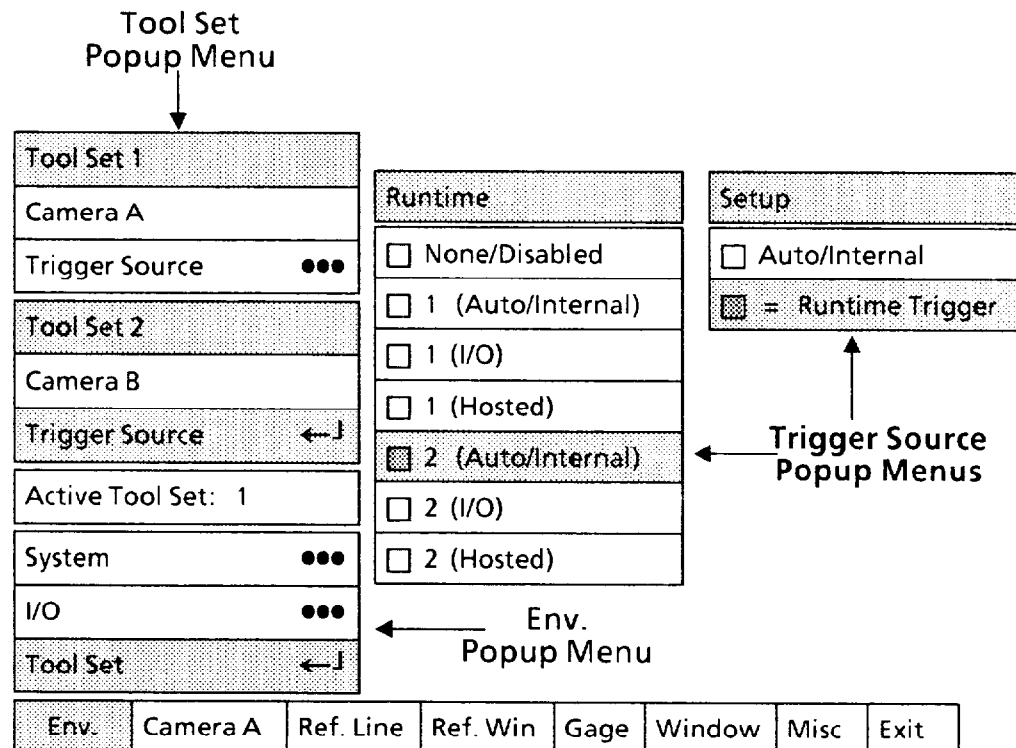

Note that the 2 Auto/Internal box in the Runtime menu and the = Runtime Trigger box in the Setup menu have a shaded square (◻). This indicates that the run mode for tool set #2 currently uses the automatic internal trigger source, and the configuration ("Setup") mode use the same trigger source as the run mode.

Note also that the 1 (Auto/Internal), 1 (I/O), and 1 (Hosted) boxes are in **black** type, indicating that you cannot pick them at this time. (They will be enabled when you pick the Trigger Source menu box under Tool Set 1.)

**Selecting Tool Set Popup
Menu and Parameters
(continued)**

Selecting Tool Set #2 Camera and Trigger (continued)

Your Action

Comments

The selections in the Runtime popup menu apply only during CVIM system *run mode*. They have the following meanings:

- None/Disabled - This indicates that *no* trigger source will be enabled during the run mode.
- 2 (Auto/Internal) - This indicates that the trigger source for tool set #2 will be the CVIM module's internal circuitry. The trigger period will be one trigger pulse every 50 milliseconds, ± 5 . This is an approximate rate of 20 trigger pulses per second.
- 2 (I/O) - This indicates that the trigger source will be the #2 trigger input through the CVIM module front panel.
- 2 (Hosted) - This indicates that the trigger source will be the #2 host system trigger input through the backplane (Pyramid system), through the remote I/O port, or through the RS-232 port (computer system).
- 1 (Auto/Internal), 1 (I/O), and 1 (Hosted) - These are in **black type**, indicating that you cannot select them at this time.

The selections in the Setup popup menu apply only during CVIM system *configuration*. They have the following meanings:

- Auto/Internal - This is the same trigger source described in 2 (Auto/Internal), above. When enabled, it ensures that a "live" camera image will appear on the monitor screen during the following functions: Focus Camera, Take Snapshot, Light Reference, Snap & Analyze, Continuous S&A, Snap & Register, and Continuous S&R.
- = Runtime Trigger - At various times during tool configuration, new camera images may be required to be *synchronized* with moving workpieces. By selecting the = Runtime Trigger box, you can use the *run mode* I/O trigger source to acquire synchronized images during *tool configuration*. In this case, the CVIM system will *wait* for the trigger signal to acquire each new image.

**Selecting Tool Set Popup
Menu and Parameters**
(continued)

Selecting Active Tool Set

During CVIM system configuration, the camera image and tool set that will appear on the monitor screen depend on the setting shown in the Active Tool Set menu box, the third part of the Tool Set popup menu.

Set the Active Tool Set menu box according to which tool set you want to configure at this time.

Your Action

Comments

*Look at the Active Tool Set
menu box.*

This box indicates the currently selected "active" tool set.

If you want to configure tools in tool set #1, the menu box must display 1. If you want to configure tools in tool set #2, the menu box must display 2.

*If appropriate, pick the Active
Tool Set menu box.*

When you pick the Active Tool Set menu box, the tool set number will toggle from 1 to 2, or vice versa.

At the same time, the image on the monitor screen will change from one camera to the other *provided* that you have selected *different* cameras under Tool Set 1 and Tool Set 2.

Chapter 5 Camera and Lighting Parameters

Chapter Objectives

The objectives of this chapter are to show you how to configure the camera and lighting parameters in the Camera popup menu. This includes adjusting the camera, selecting the camera type and operating mode, and setting the lighting threshold, camera resolution, light probe, and calibration parameters.

The Camera popup menu appears when you pick the Camera menu box in the Main Configuration menu.

Configuration Categories

The main function and configuration categories in the Camera popup menu are these:

- **Focus camera.** This function is a continuous series of digitized "snapshots," and it provides a "live" image on the video monitor screen. You can use it to set up and adjust the lighting and camera.
- **Camera type/mode.** This configuration category identifies the type of camera to be used: standard, or frame reset. It also sets the operating mode when a standard camera is used: normal trigger, or delayed trigger.
- **Lighting/Resolution.** The lighting threshold adjustment enables you to maximize the contrast in a stored camera image. The resolution parameter provides you with a choice of three degrees of image resolution. You can adjust the lighting threshold for optimum contrast and select an image resolution appropriate to your application.
- **Light probe.** The light probe automatically compensates for changes in the intensity of the light falling on the workpiece. You can configure the light probe according to the type of lighting to be used in your application.
- **Object calibration.** This function compensates linear and circular gages so that they can measure a specific distance equally in both the X and Y axes, and in all angles in between. You can use this function when your application requires gages to make calibrated measurements.
- **Grid calibration.** This function compensates linear and circular gages similar to object calibration, but also compensates for optical distortion throughout the camera image. You can use this function when your application requires gages to make calibrated measurements anywhere within the camera image.

Configuring Camera and Lighting Parameters

This section shows you the details of configuring the camera and lighting parameters.

You will begin by picking the Camera menu box in the Main Configuration menu. You will then configure several parameters relating to the camera and lighting.

Before proceeding with this section, you should have read Chapter 3, *CVIM User Interface*.

Selecting Camera Popup Menu and Parameters

Your first step is to select the Camera popup menu.

Your Action
Look at the Camera menu box in the Main Configuration menu.
Pick Camera in the Main Configuration menu.

Comments
 The Camera menu box indicates the camera, A or B, that is associated with the currently active tool set.
 When you pick the Camera menu box, the Camera popup menu appears above the Main Configuration menu, as follows:

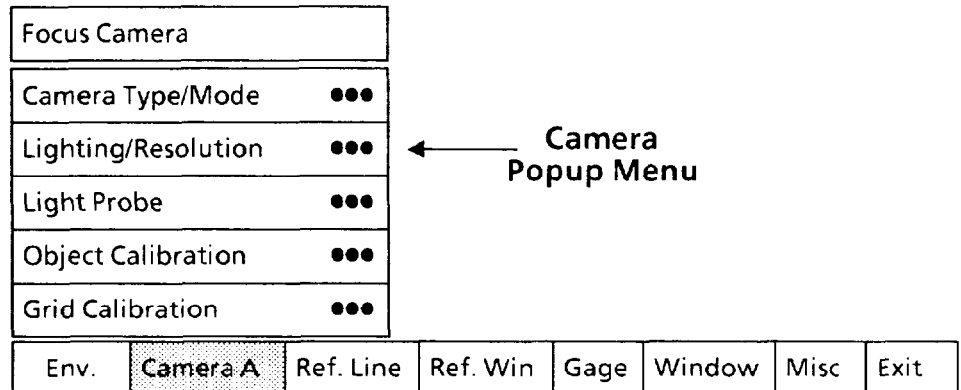

The Camera popup menu shows the six configuration categories described earlier. You should perform the Camera Type/Mode, Focus Camera and Lighting/Resolution configurations before any of the others.

**Selecting Camera Type/Mode
Popup Menu**

Select the Camera Type/Mode menu box, then select the camera type and mode.

Your Action

Pick the Camera Type/Mode menu box in the Camera popup menu.

Comments

When you pick the Camera Type/Mode menu box, the Camera Type/Mode popup menu appears above the Camera popup menu, as follows:

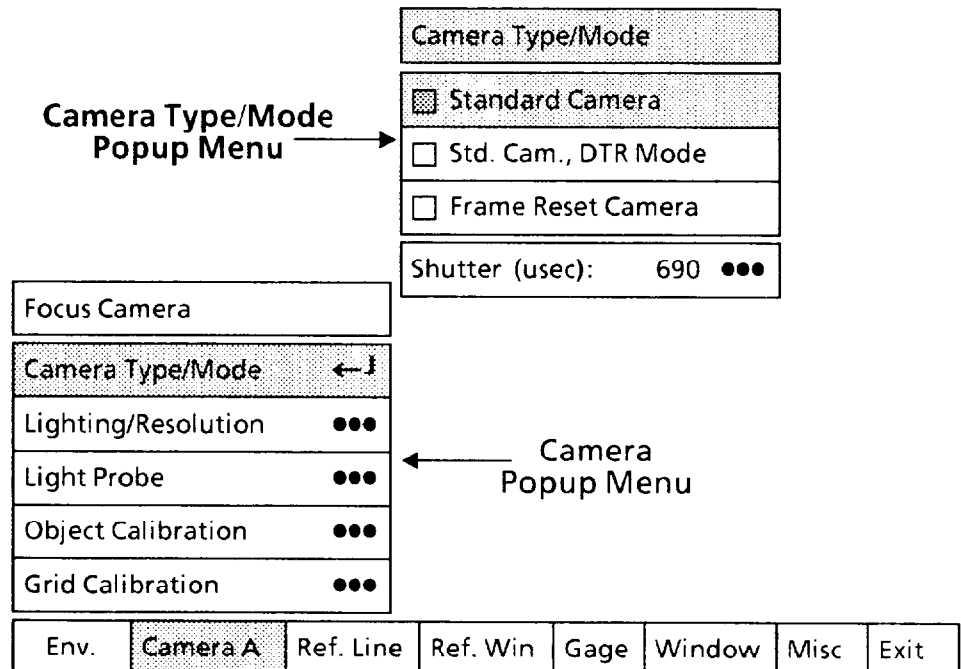

Note that the Standard Camera box in the Camera Type/Mode popup menu has a shaded square (☐). This indicates that a standard camera, with *normal* response to triggers, is currently selected.

From the top down, the selections in the Camera Type/Mode popup menu have the following meanings:

- **Standard Camera:** Selects a standard camera and *normal* response mode to trigger input signals.

Using the *normal* response mode, the CVIM system responds to trigger signals only when it is not busy processing a previous image. If the CVIM system is busy, it misses the trigger signal and does not acquire a new image.

- **Std. Cam., DTR Mode:** Selects a standard camera and a delayed reject response (DTR) to trigger input signals.

Using this response mode, the CVIM system waits until the last possible instant (waits until the end of the current camera field) before determining whether it can accept a trigger. If the CVIM system is still busy at that time, it misses the trigger and does not acquire a new image.

Selecting Camera Type/Mode Popup Menu (continued)

Your Action

Pick the appropriate box in the Camera Type/Mode popup menu.

Comments

- **Frame Reset Camera:** Selects a frame reset camera.

Using the frame reset camera, the CVIM system can reset the camera's image sensor, and the camera can then begin acquiring a new image immediately.

NOTE: If you select Frame Reset Camera and intend to use two cameras, *both* must be frame reset cameras.

When you pick the box, the new selection will be highlighted in the Camera Type/Mode popup menu.

Selecting Shutter Parameter

If you selected Standard Camera or Std. Cam., DTR Mode in the Camera Type/Mode popup menu, skip this step.

If you selected Frame Reset Camera in the Camera Type/Mode popup menu, you *must* set the Shutter parameter (in microseconds) to the same shutter speed that you set on the frame reset camera.

NOTE: If your application uses *two* frame reset cameras, both must be set to the *same shutter speed*.

To determine the correct shutter speed setting for the camera(s) used in your application, refer to the camera user manual.

Your Action

Look at the Shutter menu box in the Camera popup menu.

Comments

The Shutter menu box displays the currently selected value for the shutter parameter.

NOTE: The *allowable* range of values for the shutter parameter is 400 to 16,667. If you try to enter a number *less than* 400, the number in the Shutter menu box will remain (or change to) 0 (zero), which is the *default* value.

Selecting Shutter Parameter
(continued)

Your Action

Pick the Shutter menu box.

Comments

When you pick the Shutter menu box, the “calculator” pad appears alongside the Camera menu, as follows:

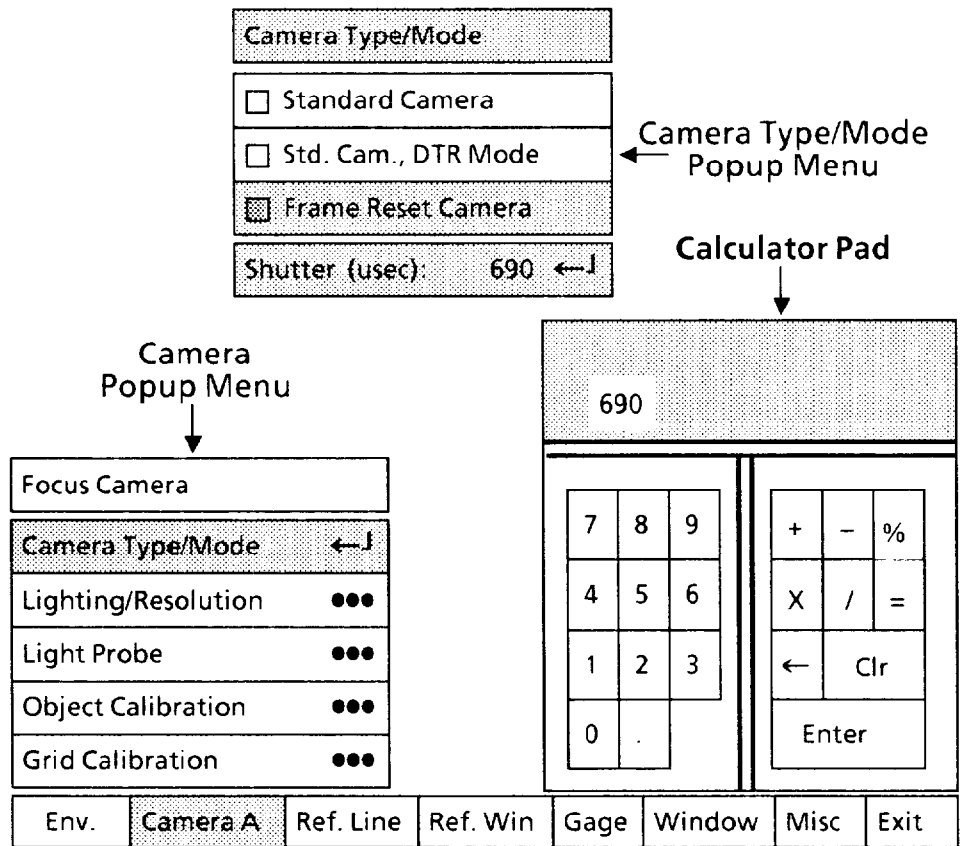

Pick each digit of the shutter parameter.

As you pick each digit, it will appear in the calculator “display.” Thus, for a value of 690, pick “6,” pick “9,” and pick “0.”

Pick the Enter key.

When you pick the Enter key, the new shutter parameter value will appear in the Shutter menu box.

Using Focus Camera Function

Select the Focus Camera function, then focus the camera lens and set the aperture for the best contrast.

NOTE: Before proceeding with this function, be sure that the "Setup" trigger source for the *active* tool set will enable trigger inputs from either the internal or an external source. If an *external* source is selected, the CVIM system will display the following message and will *wait* for the trigger signal:

The system is waiting for a trigger.
Depress the lightpen to continue.

For information on the selection of trigger sources for each tool set, refer to the appropriate sections in Chapter 4, *Operating Environment*.

Your Action

Comments

Pick the Focus Camera menu box.

When you pick the Focus Camera menu box, the screen image becomes "live," and a message box appears above the Camera popup menu, as follows:

Depress the light pen to continue

Focus Camera							
Camera Type/Mode		●●●					
Lighting/Resolution		●●●					
Light Probe		●●●					
Object Calibration		●●●					
Grid Calibration		●●●					
Env.	Camera A	Ref. Line	Ref. Win	Gage	Window	Misc	Exit

← Camera
Popup Menu

Note that the image on the monitor screen now displays what the camera currently "sees." The image is "live," and consists of a rapid, continuous series of digitized camera snapshots.

Using Focus Camera Function (continued)

Your Action	Comments
<i>Adjust the lighting and camera.</i>	Adjust the lighting fixture as necessary for optimum effect on the camera's field of view – the area in which the workpiece will be inspected. Adjust the camera focus and aperture for the clearest focus and best contrast. Also, adjust the camera's distance to the workpiece for the optimum field of view size.
<i>When all adjustments are satisfactory, exit the Focus Camera function.</i>	After you have a satisfactory image, exit the Focus Camera function by pushing in the light pen tip. The camera image will "freeze," and the message box will disappear.

Selecting Lighting/Resolution Popup Menu and Parameters

Select the Lighting/Resolution popup menu, then select the parameters in that menu.

Your Action	Comments
<i>Pick the Lighting/Resolution menu box in the Camera popup menu.</i>	When you pick the Lighting/Resolution menu box, the Lighting/Resolution popup menu appears above the Camera popup menu, as follows:

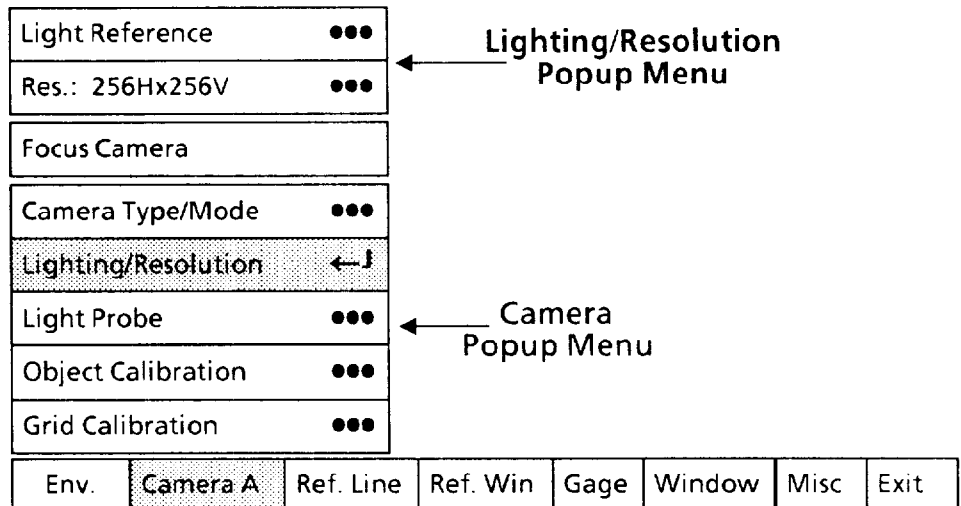

From the top down, these are the configuration parameters in the Lighting/Resolution popup menu:

- **Light Reference:** Optimizes the contrast in the stored camera image.
- **Res:** Selects the image resolution to be used in your application. The numbers refer to horizontal and vertical image resolution. This is the number of pixels along the horizontal and vertical axes.

**Selecting Lighting/Resolution
Popup Menu and Parameters**
(continued)

Selecting Resolution Popup Menu

Select the Resolution popup menu, then select the camera image resolution required for your application.

NOTE: Be sure that the camera image resolution that you select is the one you want for your application. If you *change* the resolution after you have configured the tools, you may need to re-configure those tools.

Your Action

Look at the Res menu box in the Lighting/Resolution popup menu.

Comments

The Res menu box displays the currently selected image resolution.

Refer to the *Camera Parameters* table in Appendix B for the image resolution you selected for the currently active tool set. If the resolution you checked in that table is *not* currently displayed in the Res menu box, use the next steps to select a different resolution.

Pick the Res menu box, if appropriate.

When you pick the Res menu box, the Resolution popup menu appears alongside the Lighting/Resolution popup menu, as follows:

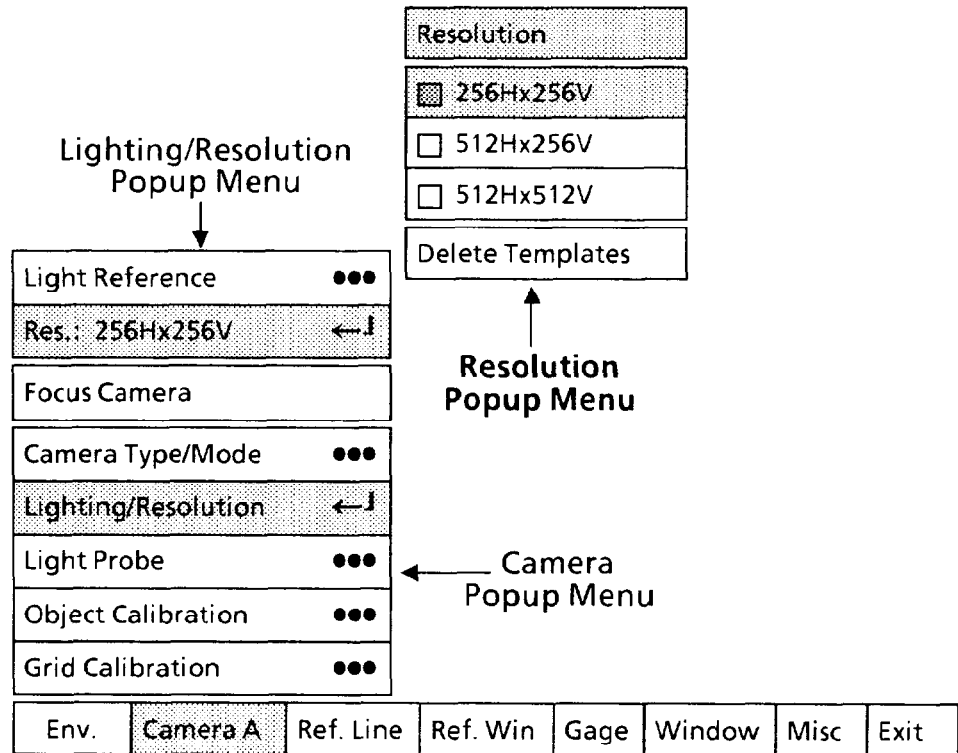

Note that the 256Hx256V box in the Resolution popup menu has a shaded square (☑). This indicates that the currently selected camera image resolution is based on 256 pixels along both the vertical and horizontal axis.

**Selecting Lighting/Resolution
Popup Menu and Parameters
(continued)**

Selecting Resolution Popup Menu (continued)

Your Action

Comments

NOTE 1: During runmode operation, the CVIM system *displays* all camera images with 256-pixel vertical resolution *regardless* of the resolution selected in the Resolution popup menu. Consequently, when the CVIM system returns to the setup mode from the run mode, and the selected resolution is 512H x 512V, any "learn" operation that you perform on the *run mode* camera image may have a different result from the result indicated in the Results Page or from prior learn operations.

Thus, to regain a *full* (512V) resolution image, you must acquire a new camera image using either the Snapshot or the Focus Camera function.

NOTE 2: If the Delete Templates box is in *light* type and the resolution boxes are in **black** type, it means that at least one window is configured for the Template Match operation, and a template has been *saved*. It also means that an "active feature" has been *saved* in at least one reference window. In both cases, the windows may be either *enabled* or *disabled*.

Before you can change the image resolution, you must *first* pick the Delete Templates box.

When you pick the Delete Templates box, the following message appears in the upper-left corner of the monitor screen:

WARNING: All templates and features for tool set 1 must be deleted before the resolution can be modified. Reselect to confirm.

Pick the same box again to continue.

When you pick the same box the second time, *the saved templates and/or "active features" will be erased*. At the same time, the resolution boxes will change to *light* type, and you can proceed to change the image resolution if you wish.

Pick the appropriate box in the Resolution popup menu.

When you pick a box in the Resolution popup menu, the following message will appear in the message box at the upper-left corner of the monitor screen:

WARNING: Selecting a new camera resolution will require recalibration and may invalidate the tool results. Reselect to confirm.

The purpose of this message is to warn you that changing the image resolution will change the calibration and may invalidate tool results.

**Selecting Lighting/Resolution
Popup Menu and Parameters**
(continued)

Selecting Resolution Popup Menu (continued)

Your Action

Comments

Pick the same box again to complete the change.

When you pick the same box the second time, the new selection will be highlighted in the Resolution popup menu and will appear in the Res menu box.

Setting Light Reference Threshold

Select the Light Reference slide bar, then adjust the contrast in the image to its optimum level.

The function of the light reference threshold adjustment is to optimize image contrast *around the part of the workpiece that is to be inspected*. The corresponding assumption is that the contrast levels in all *other* parts of the image are not important to the outcome of the inspection.

Your Action

Comments

Pick the Light Reference menu box in the Lighting/Resolution popup menu.

When you pick the Light Reference menu box, the REFERENCE slide bar and its two cursors will appear at the right edge of the screen, as follows:

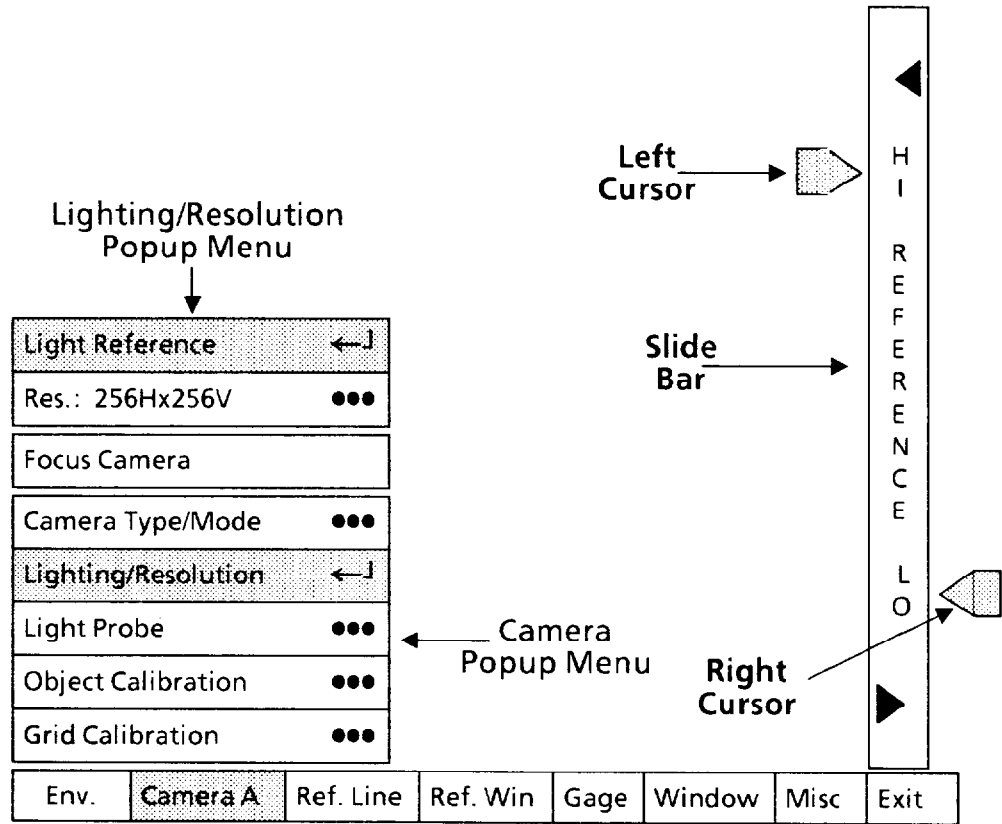

NOTE: Some parts of the camera image may have turned *green* and/or *blue* at this time. If so, ignore it for now.

**Selecting Lighting/Resolution
Popup Menu and Parameters**
(continued)

Setting Light Reference Threshold (continued)

Your Action	Comments
<i>Pick the left cursor.</i>	When you pick the left cursor, its color changes to yellow. You can now “drag” the cursor up and down.
<i>Drag the left cursor to its <u>topmost</u> position.</i>	This <i>initializes</i> the “high reference” to 150.
<i>Pick the right cursor.</i>	
<i>Drag the right cursor to its <u>bottommost</u> position.</i>	This <i>initializes</i> the “low reference” to 0 (zero).
	NOTE: The green and blue colors referred to earlier are provided to assist you in visually setting the light reference threshold. They have the following meanings:
	<u>Green:</u> All <i>green</i> areas of the camera image will turn completely white when you exit the Light Reference adjustment.
	<u>Blue:</u> All <i>blue</i> areas of the camera image will turn completely black when you exit the Light Reference adjustment.
	If any part of the screen image is still green and/or blue at this time, perform the following <i>two</i> additional steps. If not, skip these two steps.
<i>Pick the Focus Camera menu box.</i>	When you pick the Focus Camera menu box, the image on the screen will be “live” again, and the message box will reappear.
<i>Adjust the lens aperture to its <u>optimum</u> setting.</i>	A smaller f-stop provides a greater depth of field.
	<i>Use the “help” menu for the next two steps.</i>
<i>Drag the <u>left</u> cursor slowly downward.</i>	Drag the <i>left</i> cursor slowly downward until the green color begins to “invade” the workpiece image, then reverse the cursor until the green color just barely disappears from the workpiece image.
	On the help menu, a “high reference” range of 85 to 95 typically provides the best results.
<i>Drag the <u>right</u> cursor slowly upward.</i>	Drag the <i>right</i> cursor slowly upward until the blue color begins to “invade” the workpiece image, then reverse the cursor until the blue color just barely disappears from the workpiece image.
	On the help menu, a “low reference” range of 7 to 12 typically provides the best results.
	Although the image contrast should now be optimized, you may need to experiment by making slight changes in the aperture setting, the threshold settings (for gages and windows), and the light reference threshold. Your objective is to get the most <i>consistent</i> results from the inspection tools.

Selecting Light Probe Popup Menu and Parameters

Select the Light Probe popup menu, then select and configure the parameters and functions in that menu.

NOTE: You must configure a light probe for *each camera* if your application requires two cameras. Otherwise, configure only the light probe for the camera port (A or B) that you will be using.

The light probe detects the intensity of light at a particular place within the camera's field of view. The probe measures light intensity on a scale of 0 to 63, where 0 is the darkest light intensity value and 63 the brightest.

The light probe is a pre-inspection tool: If the probe finds that the light intensity has changed, but is *within* previously specified range limits, the CVIM system will provide brightness compensation for the light variations and *continue* the inspection.

Brightness compensation modifies gray scale values from the camera to best match the original image. Thus, the CVIM system can continue inspections in spite of light variations, so long as those variations remain within the specified range limits.

If the light intensity is *above or below* a specified limit, the CVIM system discontinues the inspection and reports the condition on a specified output line.

The basic steps for configuring the light probe are these:

- Enable the light probe for use with either a strobe light or continuous light.
- Prepare a light intensity reference patch and position it within the screen image.
- Position the light probe "box" over the reference patch in the screen image.
- Perform a "learn" function to get the light intensity value that the light probe "sees" at the reference patch.
- Determine the light-intensity range limits for the light probe.

The following steps show you the details of configuring the light probe.

Selecting Light Probe Popup Menu and Parameters (continued)

Your Action	Comments
Pick the Light Probe menu box.	When you pick the Light Probe menu box, the Light Probe popup menu appears above the Camera A (or B) popup menu, as follows:

Status Disabled	●●●	
Pick & Place	●●●	
Learn: 45.140		← Light Probe Popup Menu
Range/Outputs	●●●	
Focus Camera		
Camera Type/Mode	●●●	
Lighting/Resolution	●●●	
Light Probe	←	← Camera Popup Menu
Object Calibration	●●●	
Grid Calibration	●●●	
Env.	Camera A	Ref. Line
		Ref. Win
		Gage
		Window
		Misc
		Exit

These are the configuration parameters and functions in the Light Probe popup menu:

- **Status:** Selects the Probe Status popup menu, from which you can enable or disable the probe and select the image field that the probe is to measure.
- **Pick & Place:** Enables you to position the light probe on the screen, subject to the setting in the Status menu box.
- **Learn:** Takes a sample reading of the light probe each time that you pick this menu box.
- **Range/Output:** Selects the acceptable range limits for the values that the light probe reads, and assigns the results (pass/fail) to the output lines that you specify.

In addition to the Light Probe popup menu, a small red box will appear somewhere on the screen, as follows:



Selecting Light Probe Popup Menu and Parameters
(continued)

Selecting Probe Status Popup Menu

Select the Probe Status popup menu, then select the light probe status required in your application.

Your Action

Comments

Look at the Status menu box in the Light Probe popup menu.

The Status menu box displays the currently selected probe status for camera A (or B).

Refer to the *Camera Parameters* table in Appendix B for the light probe status you selected for the camera currently appearing in the Camera menu box. If the status you checked in that table is *not* currently in the Status menu box, use the next steps to select a different status.

Pick the Status menu box in the Light Probe popup menu.

When you pick the Status menu box, the Probe Status popup menu appears alongside the Light Probe popup menu, as follows:

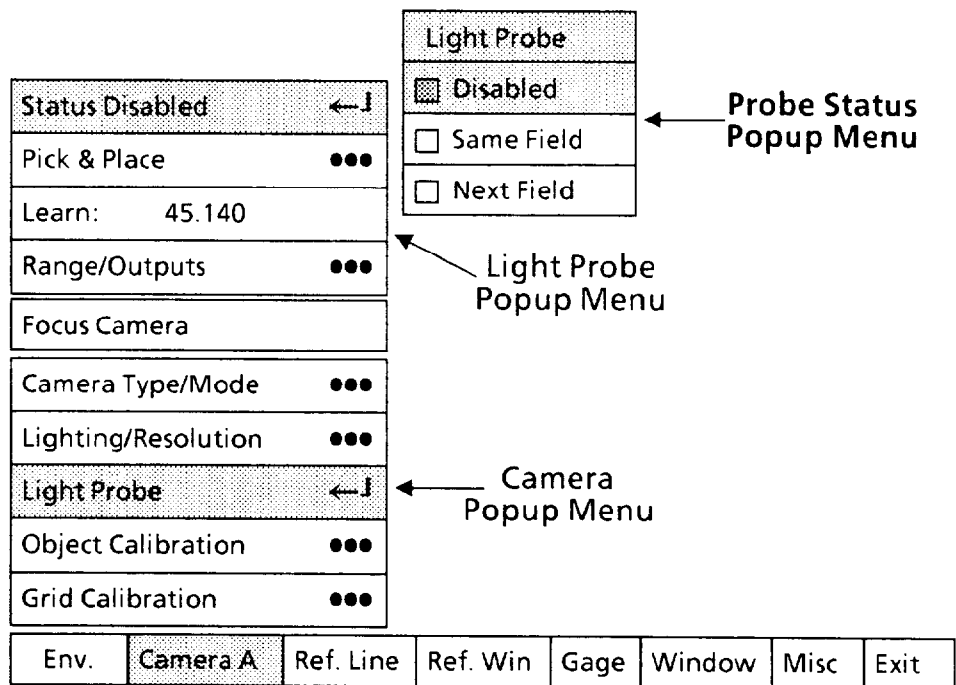

Note that the Disabled box in the Probe Status popup menu has a shaded square (☐). This indicates that the light probe (for camera A) is off. Note also that Range/Outputs, Learn, and Pick & Place are in **black** type. This means that you cannot pick these boxes at this time.

**Selecting Light Probe Popup
Menu and Parameters**
(continued)

Your Action

Selecting Probe Status Popup Menu (continued)

Comments

The probe status parameters have the following meanings:

- **Disabled:** This means that the light probe for camera A (in this case) is off (“disabled”).

- **Same Field:** This means that the light probe must lie somewhere *approximately* within the top fifth of the monitor screen (it depends on tool locations). The light probe will examine the light intensity within this area and apply any required brightness compensation to the *remaining* part of the *same image field*.

You must select Same Field if your application will be using a strobe light.

- **Next Field:** This means that the light probe can lie anywhere in the screen image field. The light probe will examine the light intensity within *this* field, but will apply any required brightness compensation to the *next image field*. Processing time increases when you select Next Field.

You can select Next Field if your application will be using the full screen image.

*Pick the appropriate box in
the Probe Status popup menu.*

When you pick the box, the new selection will be highlighted in the Probe Status popup menu and will appear in the Status menu box.

Using Pick & Place Function

The following steps show you how to use the Pick & Place function for positioning the light probe.

The basic steps for positioning the light probe are these:

- **Attach a reference “patch”** of light gray-colored tape near the workpiece so that it always appears in the same place within the screen image field. This material will be the permanent light-intensity reference patch for the light probe.

- **Position the light probe symbol** over the reference patch in the screen image.

Use the following steps to position the light probe.

Your Action

*Position a light-gray
light reference patch in the
screen image field.*

Comments

The *exact* shade of gray will depend on the specific lighting conditions in you application. You may have to try various shades to find one that results in a light probe reading of about 40-50 when you perform a “learn” operation later on.

Selecting Light Probe Popup Menu and Parameters (continued)

Using Pick & Place Function (continued)

Your Action

Pick the Pick & Place menu box in the Light Probe popup menu.

Comments

When you pick the Pick & Place menu box, a small magenta square will appear inside the light probe:

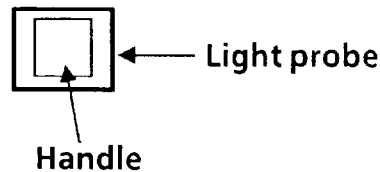

Limit line
(Applies to Same Field status only)

The magenta square is the “handle” that the light pen uses to move the probe around the screen image.

Also appearing near the top of the screen is a green limit line. If you have selected Same Field status, you can move the probe anywhere *above* the green limit line.

If you’ve selected Next Field status, you can move the probe *anywhere* on the screen image.

Aim the light pen at the light probe handle.

Aim the light pen at the light probe *handle* until the light pen “sees” the handle. You may have to move the light pen around slightly.

When the light pen sees the handle, a larger “highlight” square will surround the light probe box:

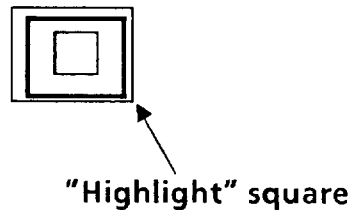

Hold the pen steady in this position – the appearance of the “highlight” square means that the light pen is now properly aimed at the handle.

Selecting Light Probe Popup Menu and Parameters (continued)

Using Pick & Place Function (continued)

Your Action	Comments
<i>Pick the light probe handle.</i>	You can now “drag” the light probe around on the screen. When you move the pen, the probe will follow.
<i>Drag the light probe over the light reference patch.</i>	Note: Keep the pen tip within about one-half inch of the screen. When you have the light probe centered over the light reference patch, press the pen against the screen to “lock” the probe at that position.
<i>If necessary, use the vernier arrows to “fine-tune” the position of the probe.</i>	You can position the probe more <i>precisely</i> by using the <i>vernier</i> arrows. These arrows enable you to move the probe in increments of one pixel. You can access the vernier arrows while either <i>picking</i> the probe handle or <i>placing</i> the probe.
<i>Press and hold the light pen tip against the probe handle.</i>	Hold the light pen tip in for about <i>one second</i> . The vernier arrows will appear in the lower-right corner of the screen:

VERNIER ARROWS

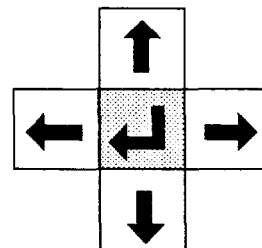

Move probe up,
down, left, or
right

<i>Pick an arrow once to move the probe <u>one pixel</u> in the arrow's direction.</i>	Pick the up, down, right, or left arrow, as appropriate, to move the probe <i>one pixel</i> in the direction indicated by the arrow.
<i>Pick and hold an arrow to move the probe <u>continuously</u>.</i>	When you pick and <i>hold</i> an arrow, the probe will move slowly for the first five or six pixels. It will then accelerate to a more rapid rate of movement.
<i>Pick the “return” symbol to <u>release</u> the vernier arrows.</i>	When the probe is properly positioned, pick the “return” symbol (←┘) to <i>release</i> the vernier arrows and return to the pick-and-place mode.

Selecting Light Probe Popup Menu and Parameters (continued)

Using Learn Function

The following step shows you how to use and interpret the Learn function.

Your Action

Pick the Learn menu box in the Light Probe popup menu.

Comments

When you pick the Learn menu box, the light probe will calculate ("learn") the average light intensity value at the light reference patch and will display this value, in the range of 0.000 (darkest) to 63.000 (lightest), in the Learn menu box.

The light intensity value reflects the relative brightness of the reference patch. This value should be approximately 40-50 for adequate light compensation flexibility.

NOTE: You may have to try several patches, each with a different shade of gray, to find one that results in a value close to 40-50.

Assigning Range Limits and Output Lines

Range Limits – the term *range limit*, as it applies to the light probe, refers to a *level of light intensity* above or below which the CVIM system might not (or cannot) successfully perform an inspection.

In general, range limits specify the upper and lower boundaries of acceptable inspection results. For the light probe, this means that any increase or decrease in light intensity *beyond* one of these limits will result in unreliable light compensation.

The CVIM system provides *two* sets of range limits: *warning range* limits, and *fault range* limits. Warning range limits must always lie at or *within* fault range limits.

The two sets of range limits have this relationship:

$$LF \leq LW \leq \text{NOMINAL} \leq UW \leq UF$$

The **NOMINAL** value refers to a desired middle-of-the-range value. **LW** and **UW** are the lower and upper warning limits. **LF** and **UF** are the lower and upper fault limits.

Here is a general example, using a nominal value of 45, to demonstrate the concept:

- The **LW** value (lower warning limit) could be set to 40.
- The **UW** value (upper warning limit) could be set to 50.
- The **LF** value (lower fault limit) could be set to 35.
- The **UF** value (upper fault limit) could be set to 55.

Selecting Light Probe Popup Menu and Parameters (continued)

Assigning Range Limits and Output Lines (continued)

During an inspection, if the light intensity goes outside either warning limit, the CVIM system will generate a warning signal. If the light intensity goes outside *both* a warning limit *and* a fault limit, the CVIM system will generate a warning signal *and* a fault signal.

In a practical application, a warning signal can function as an early indication of a deteriorating light level. A fault signal can indicate a “hard” failure, such as a burned-out lamp. In each case, the signal that results when a range limit is exceeded can be used to alert operations personnel to fix the problem.

Output Lines – the term *output lines* refers to the 14 discrete output lines that you can configure to carry various signals to your production equipment. Of these signals, the “results” signals indicate whether or not any of the warning and/or fault range limits have been exceeded.

In Chapter 4, *Operating Environment*, you can assign signal functions to the output lines. In this chapter, you can assign the light probe warning and fault “results” to any output lines that you designated earlier as “results” lines.

Here are a couple of examples of using the light probe warning and fault range limits and their corresponding output lines:

Example 1: If the light intensity of a lamp dims to the point that the light probe value falls below the specified warning limit, the CVIM system will issue a signal to the “results” output line that you specified for the light probe warning signal. The inspection processing would then continue.

The warning signal could be used to inform operations personnel that the lamp needs to be adjusted or replaced soon, but not necessarily right away. They could then plan the lamp adjustment or replacement at a convenient time, if possible, such as during a shift change.

Example 2: If a lamp burns out, the light intensity will drop abruptly below both the warning limit and the fault limit. In this case, the CVIM system will issue both a warning signal and a fault signal to the specified output lines, and the inspection processing would then stop.

The fault signal could be used to inform operations personnel that the lamp needs to be replaced right away.

**Selecting Light Probe Popup
Menu and Parameters
(continued)**

Assigning Range Limits and Output Lines (continued)

Use the following steps to *determine* the appropriate range limits for your application and then *configure* them on your CVIM system.

Your Action

Comments

*Perform a Learn function,
as described earlier.*

Before you perform the “learn” function, be sure the light probe is properly positioned over the reference patch in the screen image.

NOTE: The reference patch should be positioned so that the light probe is as *high* as possible in the screen image if you selected the Same Field operation for the light probe.

*Note the light probe reading
in the Learn menu box.*

The light probe reading should be between 40 and 50. If it is *not* 40 to 50, try reference patches with different shades of gray.

*Calculate and record the
upper warning range limit.*

To calculate the *upper warning* range limit, multiply the reading by 15%, *add* that value to the reading, and write the result on a sheet of paper.

For example, if the reading is 45, 15% of 45 is 6.75. Adding 6.75 to 45 equals 51.75, the upper warning limit.

*Calculate and record the
lower warning range limit.*

To calculate the *lower warning* range limit, multiply the reading by 12%, *subtract* that value from the reading, and write the result on a sheet of paper.

For example, if the reading is 45, 12% of 45 is 5.4. Subtracting 5.4 from 45 equals 39.6, the lower warning limit.

*Calculate and record the
upper fault range limit.*

To calculate the *upper fault* range limit, multiply the reading by 25%, *add* that value to the reading, and write the result on a sheet of paper.

For example, if the reading is 45, 25% of 45 is 11.25. Adding 11.25 to 45 equals 56.25, the upper fault limit.

*Calculate and record the
lower fault range limit.*

To calculate the *lower fault* range limit, multiply the reading by 20%, *subtract* that value from the reading, and write it on a sheet of paper.

For example, if the reading is 45, 20% of 45 is 9. Subtracting 9 from 45 equals 36, the lower fault limit.

Selecting Light Probe Popup Menu and Parameters (continued)

Assigning Range Limits and Output Lines (continued)

Your Action

Comments

Pick the Range/Outputs menu box in the Range/Outputs popup menu.

When you pick the Range/Outputs menu box, two tables will appear on the screen, as follows:

	FAULT RANGE	WARNING RANGE
High	63.000 ●●●	63.000 ●●●
Low	0.000 ●●●	0.000 ●●●
Output	None ●●●	None ●●●

Nominal	45.140
Samples	1020
Maximum	47.125
Minimum	43.640
Mean	45.909
Std.Dev	0.076

↑
Range/Output Setup Table Inspection Statistics Table

Status: Next Field	●●●
Pick & Place	●●●
Learn: 45.140	
Range/Outputs	← J
Focus Camera	
Camera Type/Mode	●●●
Lighting/Resolution	●●●
Light Probe	← J
Object Calibration	●●●
Grid Calibration	●●●

← Light Probe Popup Menu ← Camera Popup Menu

Env.	Camera A	Ref. Line	Ref. Win	Gage	Window	Misc	Exit
------	----------	-----------	----------	------	--------	------	------

The Range/Output Setup table is the one you will use to set the range limits and assign the output lines. The numbers appearing in it now are the limits and lines set previously. Note that each box in the table has the three dots (●●●), which indicates that you will need to pick each box, one at a time, in order to set its value.

The Inspection Statistics table shows “results” data from a series of trial inspections performed while the CVIM system is running inspections in the “learn” mode. These numbers can help you choose the best values for the range limits. Chapter 10, *Runtime Operations* has more information about this subject.

Selecting Light Probe Popup Menu and Parameters
(continued)

Assigning Range Limits and Output Lines (continued)

The next steps show you how to select values for the range limits

NOTE: The order in which these steps are presented may not be appropriate in *all* cases. If not, a message will appear that says: VALUE OUT OF RANGE. For example, this message will appear if you try to change the *upper* warning range limit to a value below the *lower* warning range limit.

Your Action

Comments

Pick the upper box under WARNING RANGE.

This is the warning range upper ("High") limit. When you pick this box, the calculator pad appears on the screen:

The screenshot shows a software interface with several components:

- Range/Output Setup Table:** A table with columns for FAULT RANGE and WARNING RANGE, and rows for High, Low, and Output. The High row shows 63.000 in both columns. The Low row shows 0.000 in both. The Output row shows None in both.
- Inspection Statistics Table:** A table with two columns: the first lists statistics (Nominal, Samples, Maximum, Minimum, Mean, Std.Dev) and the second lists values (45.140, 1020, 47.125, 43.640, 45.909, 0.076).
- Light Probe Popup Menu:** A vertical list of menu items: Status: Next Field, Pick & Place, Learn: 45.140, Range/Outputs (highlighted), Focus Camera, Camera Type/Mode, Lighting/Resolution, Light Probe (highlighted), Object Calibration, and Grid Calibration.
- Calculator Pad:** A numeric keypad with digits 0-9, a decimal point, and function keys: +, -, %, X, /, =, ←, Clr, and Enter.
- Bottom Bar:** A row of buttons: Env., Camera A (selected), Ref. Line, Ref. Win, Gage, Window, Misc, and Exit.

Arrows indicate interactions: 'Range/Output Setup Table' points to the High row; 'Light Probe Popup Menu' points to the Range/Outputs item; 'Calculator Pad' points to the calculator; 'Camera Popup Menu' points to the Light Probe item.

Pick each digit of the upper warning limit value.

As you pick each digit, it will appear in the calculator "display." Thus, for a value of 50, pick "5," then pick "0."

Pick the Enter key.

When you pick the Enter key, the new value will appear in the upper box under WARNING RANGE.

Pick the middle box under WARNING RANGE.

This is the warning range lower ("Low") limit.

Pick each digit of the lower warning limit value.

As you pick each digit, it will appear in the calculator "display."

Selecting Light Probe Popup Menu and Parameters
(continued)

Assigning Range Limits and Output Lines (continued)

Your Action	Comments
Pick the Enter key.	When you pick the Enter key, the new value will appear in the middle box under WARNING RANGE.
Pick the <u>upper</u> box under FAULT RANGE.	This is the fault range upper ("High") limit.
Pick each digit of the upper fault limit value.	As you pick each digit, it will appear in the calculator "display."
Pick the Enter key.	When you pick the Enter key, the new value will appear in the upper box under FAULT RANGE.
Pick the <u>middle</u> box under FAULT RANGE.	This is the fault range lower ("Low") limit.
Pick each digit of the lower fault limit value.	As you pick each digit, it will appear in the calculator "display."
Pick the Enter key.	When you pick the Enter key, the new value will appear in the middle box under FAULT RANGE.
Pick the <u>lower</u> box under WARNING RANGE.	When you pick this box, a variation of the Output Assignment popup menu appears on the screen, as follows:

	FAULT RANGE	WARNING RANGE
High	53.000	50.000 ●●●
Low	37.000 ●●●	40.000 ●●●
Output	None ●●●	None ←J

##	TOOLSET/USAGE
<input checked="" type="checkbox"/>	No Output
<input type="checkbox"/>	1 1/Results
<input type="checkbox"/>	2 1/Results
<input type="checkbox"/>	3 1/Results
<input type="checkbox"/>	4 1/Results
<input type="checkbox"/>	5 2/Results
<input type="checkbox"/>	6 2/Results
<input type="checkbox"/>	7 Not Used
<input type="checkbox"/>	8 Not Used
<input type="checkbox"/>	9 Not Used
<input type="checkbox"/>	10 Not Used
<input type="checkbox"/>	11 Not Used
<input type="checkbox"/>	12 Not Used
<input type="checkbox"/>	13 Not Used
<input type="checkbox"/>	14 Not Used

Status: Next Field	●●●
Pick & Place	●●●
Learn: 45.140	
Range/Outputs	←J
Focus Camera	
Camera Type/Mode	●●●
Lighting/Resolution	●●●
Light Probe	←J
Object Calibration	●●●
Grid Calibration	●●●

Env.	Camera A	Ref. Line	Ref. Win	Gage	Window	Misc	Exit
------	----------	-----------	----------	------	--------	------	------

**Selecting Light Probe Popup
Menu and Parameters**
(continued)

Assigning Range Limits and Output Lines (continued)

Your Action

Comments

This is the Output Line Selection popup menu. It shows the output line functions that you assigned to the Output Assignment popup menu in Chapter 4, *Operating Environment*.

NOTE: This menu shows that only the output lines that you designated in Chapter 4 as "1/Results" are available to *this* light probe (the one for Camera A). These appear in light type, and all others appear in **black type** (meaning that you cannot pick them).

Note also that the No Output box in the Output Line Selection popup menu has a shaded square (◻). This indicates that *no* output line is currently assigned to carry WARNING RANGE signals for *this* (Camera A) light probe.

If you prepared an Output Line Planning Sheet in Appendix A, refer to it for the output line assignments for *this* (Camera A) light probe.

*Pick the output line number
for the WARNING RANGE.*

From the Output Line Selection popup menu, pick one of the available output lines boxes labeled "1/Results". When you pick the appropriate box, the shaded square will shift to it.

In addition, the output line number appears in the lower box under WARNING RANGE.

*Pick the lower box under
FAULT RANGE*

*Pick the output line number
for the FAULT RANGE.*

From the Output Line Selection popup menu, pick one of the available output lines boxes labeled "1/Results". When you pick the appropriate box, the shaded square will shift to it.

In addition, the output line number appears in the lower box under FAULT RANGE.

**Using Object Calibration
and Grid Calibration**

NOTE: Object and grid calibration applies *only* to gages configured for linear or angular gaging measurements.

Ideally, a ratio of 1 to 1 should exist for a measurement of the same physical distance along the X and Y axis of the screen image. But, because of image resolution, pixel shape, and optical and other distortions, the *actual* ratio may *not* be 1 to 1.

Thus, an *uncalibrated* gage will return *different* values for the *same physical distance* along the X and Y axes, and for angles in between. The reason is that the gage “measures” the number of pixels along its length, and a gage of a specific length will encounter a different number of pixels on the X and Y axes.

Object and grid calibration can compensate for these distortions and, at the same time, convert the calibrated measurements into inches or centimeters. The main difference between object and grid calibration is this:

Object calibration uses four reference points – two on each axis – as the basis for its calibration calculation. It is most accurate when the inspected parts appear in the same part of the screen image where the calibration is performed.

Grid calibration uses multiple reference points as the basis for its calibration calculation. It is more accurate than object calibration, and can compensate for distortions in *all* areas of the screen image.

In performing object and grid calibration, the CVIM system measures a *calibration object* or *calibration grid* of known dimensions, then calculates a calibration factor on the basis of these measurements. The CVIM system will then apply the calibration factor to all subsequent linear and angular gaging measurements.

The basic steps in object and grid calibration are these:

- Object calibration: Position the *calibration object* in the part of the screen image where your application will be performing the gage measurements.
- Grid calibration: Position the *calibration grid* to fill as much of the screen image as your application needs to perform the gage measurements, then align the grid with the X and Y axes of the screen image.
- Position the X and Y axes of the calibration “window” so that they lie properly over the calibration object or grid.
- Define the edges where the window’s X and Y axes intersect the calibration object or grid.
- Calibrate the CVIM system to the calibration object or grid.
- Enter the *actual* X and Y “edge-to-edge” dimensions.

The following steps show you the details of performing the object and grid calibration functions.

Selecting Object Calibration Functions and Parameters

Select the Object Calibration popup menu, then select and configure the parameters and functions in that menu.

Your Action

Comments

Pick the Object Calibration menu box in the Camera popup menu.

When you pick the Object Calibration menu box, the Object Calibration popup menu appears above the Camera A (or B) popup menu, as follows:

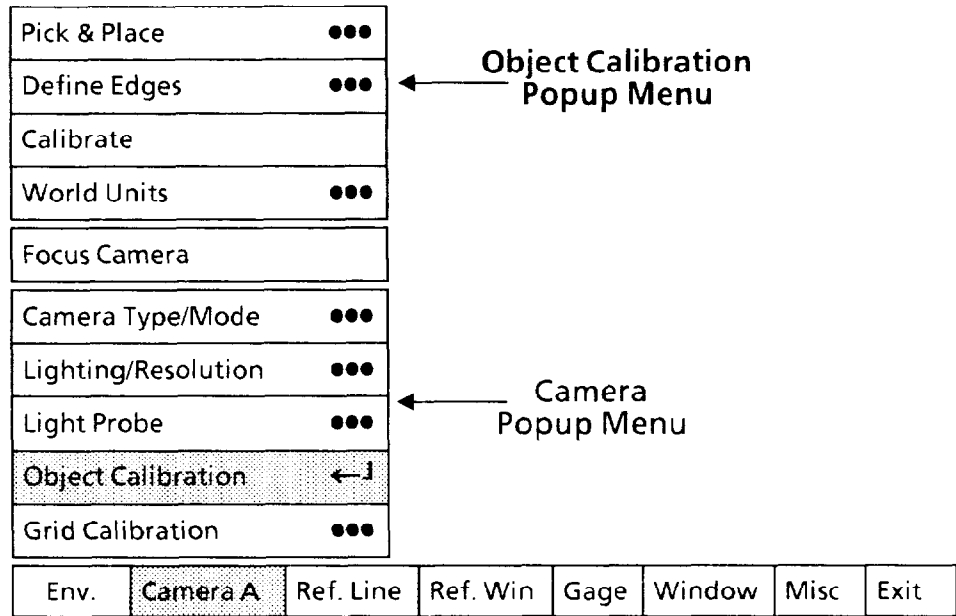

In addition to the Object Calibration popup menu, the calibration window, with X and Y axes centered in it, will appear on the screen, as follows:

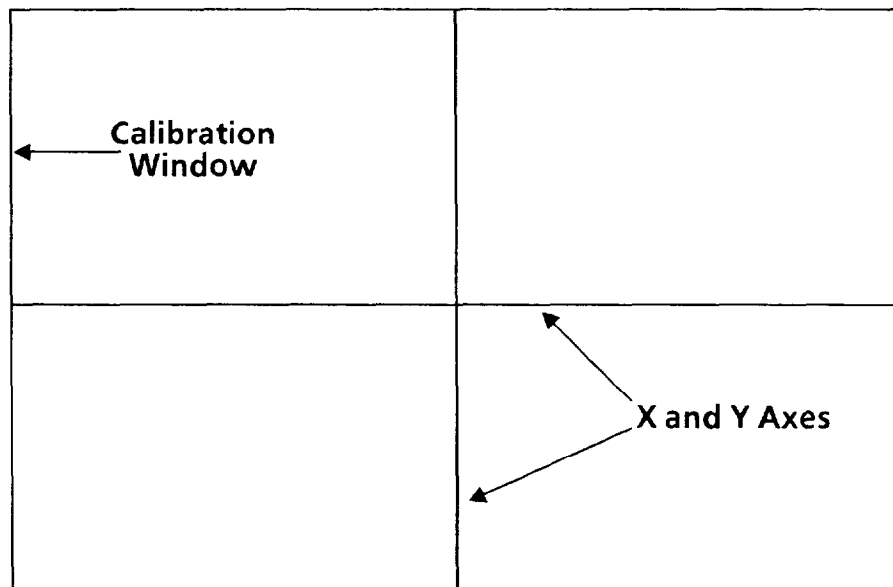

Selecting Object Calibration Functions and Parameters (continued)

Your Action

Using the Focus Camera function, correctly position the calibration object in the screen image.

Comments

The calibration window and its axes are the screen symbols for the Object Calibration function. You will use them to measure a "calibration object" of known vertical and horizontal dimensions.

Before you continue, pick the Focus Camera menu box to generate a "live image" on the monitor screen. Position the calibration object in the center of the screen so that it is aligned with the screen's X and Y axes.

Using Pick & Place Function

Select the Pick & Place function, then move the calibration window over the calibration object and set the window to the appropriate size.

Your Action

Pick the Pick & Place menu box in the Calibration popup menu.

Comments

When you pick the Pick & Place menu box, five small squares, or "handles" will appear on the X and Y axes, as follows:

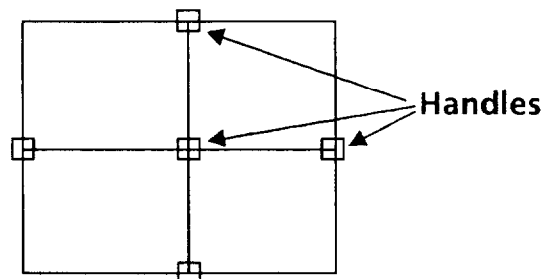

The light pen uses these handles to manipulate the calibration window on the screen image.

Aim the light pen at the center handle.

Move the light pen around slightly as you aim it at the center handle. At some position of the pen you will see a larger "highlight" square surrounding the handle:

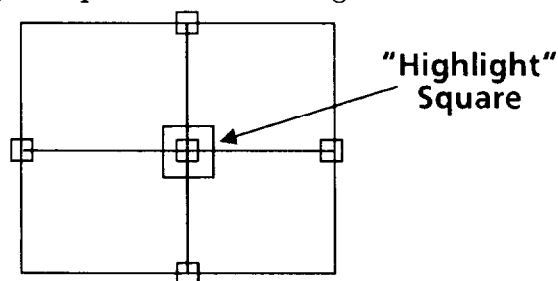

Hold the pen steady in this position – the appearance of the "highlight" square means that the light pen is now properly aimed.

**Selecting Object Calibration
Functions and Parameters
(continued)****Using Pick & Place Function (continued)****Your Action**

*Press the light pen against
the center handle.*

Comments

Press the pen firmly against the center handle, then release it. A small "X" will appear in the center of the window, and the handles will disappear, as follows:

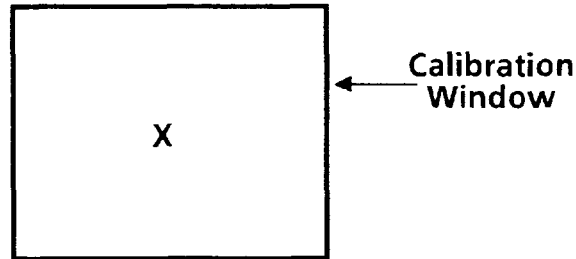

Calibration
Object →



This indicates that you can now move, or "drag," the window toward the calibration object on the monitor screen.

Selecting Object Calibration Functions and Parameters
(continued)

Using Pick & Place Function (continued)

Your Action

Drag the calibration window over the calibration object.

Comments

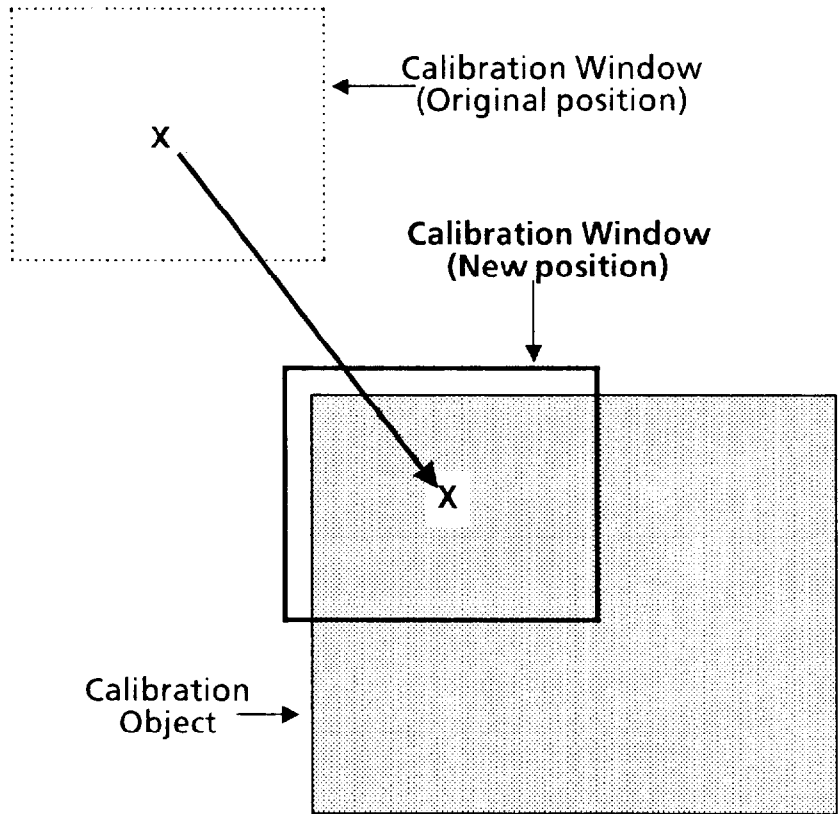

When you have dragged the window into position, press the light pen tip against the screen to "lock" the window at that position.

Aim the light pen at the rightmost handle.

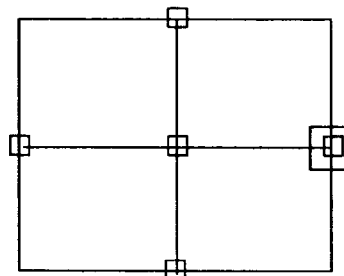

Selecting Object Calibration Functions and Parameters
(continued)

Using Pick & Place Function (continued)

Your Action

Comments

Pick the handle.

Drag the right side until it is just outside the object.

Note that the *left side* remains anchored.

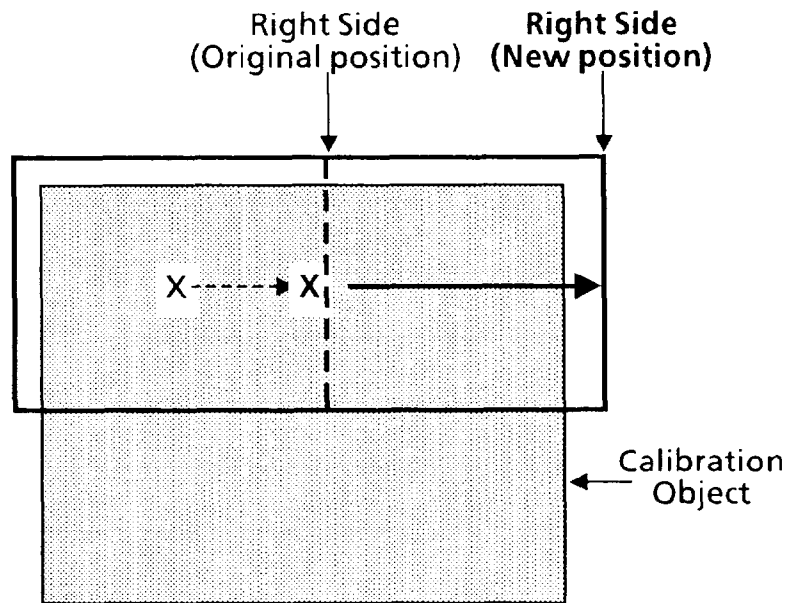

"Lock" the window's right side in position.

Aim the light pen at the bottom handle.

Continue when the highlight square appears.

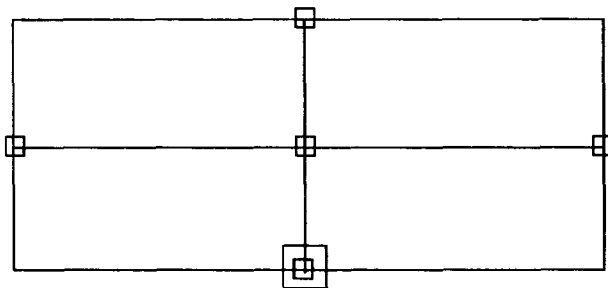

Pick the handle.

Selecting Object Calibration Functions and Parameters
(continued)

Using Pick & Place Function (continued)

Your Action

Drag the bottom side until it is just below the object.

Comments

Note that the top side remains anchored.

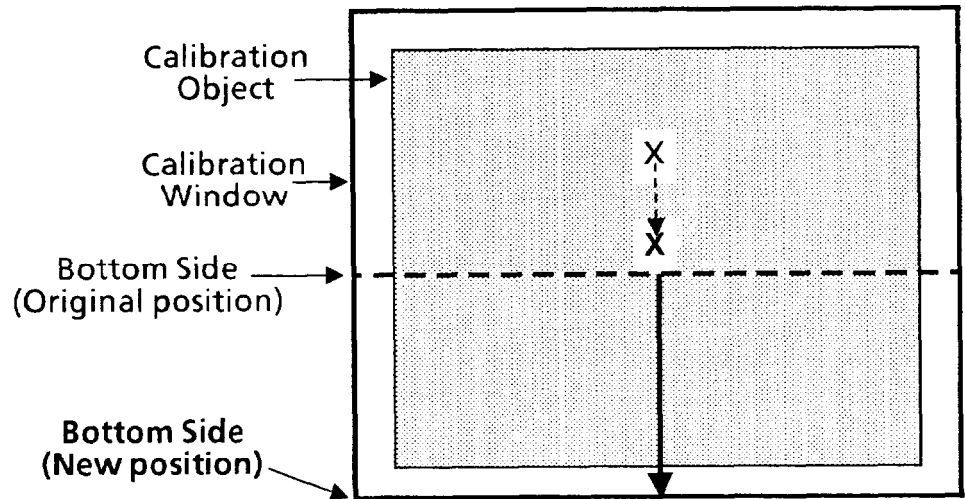

Lock the window's bottom side in position.

At this point, you have adjusted the window's position and size so that it just covers the calibration object.

The X and Y axes should look like this:

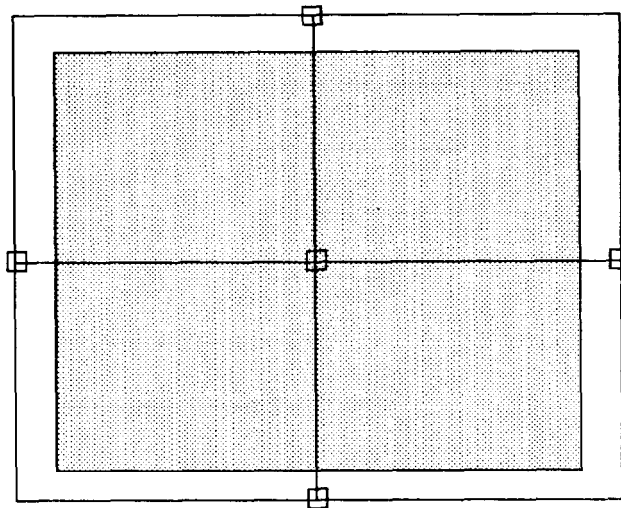

Note that the X axis is now in a position to detect the left and right edges of the calibration object, and the Y axis is in a position to detect the top and bottom edges.

Selecting Object Calibration Functions and Parameters (continued)

Using Pick & Place Function (continued)

Your Action

If necessary, use the vernier arrows to "fine-tune" the position or size of the window.

Press and hold the light pen tip against the window handle, window, or side.

Comments

You can position the calibration window and its sides more *precisely* by using the *vernier* arrows. These arrows enable you to move the window or window sides in small increments.

You can access the vernier arrows while either *picking* a window handle or *placing* the window or one of its sides.

Hold the light pen tip in for about *one second*. The vernier arrows will then appear in the lower-right corner of the monitor screen:

VERNIER ARROWS

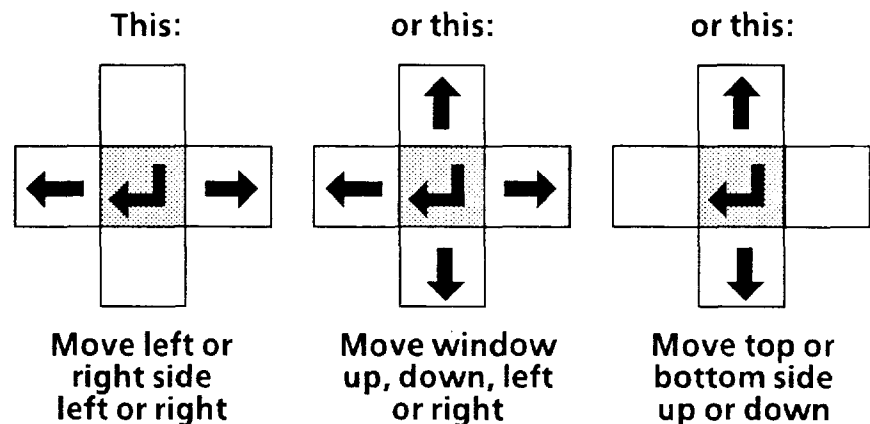

Pick an arrow once to move the window or window side one pixel in the arrow's direction.

Pick and hold an arrow to change the window size or position continuously.

Pick the "return" symbol to release the vernier arrows.

The up, down, right, or left arrow will move the entire window or window side *one pixel* in the direction indicated by the arrow.

When you pick and *hold* an arrow, the window's size or position will change slowly for the first five or six increments. It will then change at a more rapid rate.

When the window's size and/or position are correct, pick the "return" symbol (←↓) to *release* the vernier arrows and return to the pick-and-place mode.

Selecting Object Calibration Functions and Parameters
(continued)

Defining Edges

Select the Define Edges menu box, then adjust the threshold/scale cursors until an X appears on each outer edge of the calibration object along the X and Y axes.

Your Action

Pick the Define Edges menu box in the Calibration popup menu.

Comments

When you pick the Define Edges menu box, several magenta X's may appear along the axes, and a slide bar will appear at the right side of the screen, as follows:

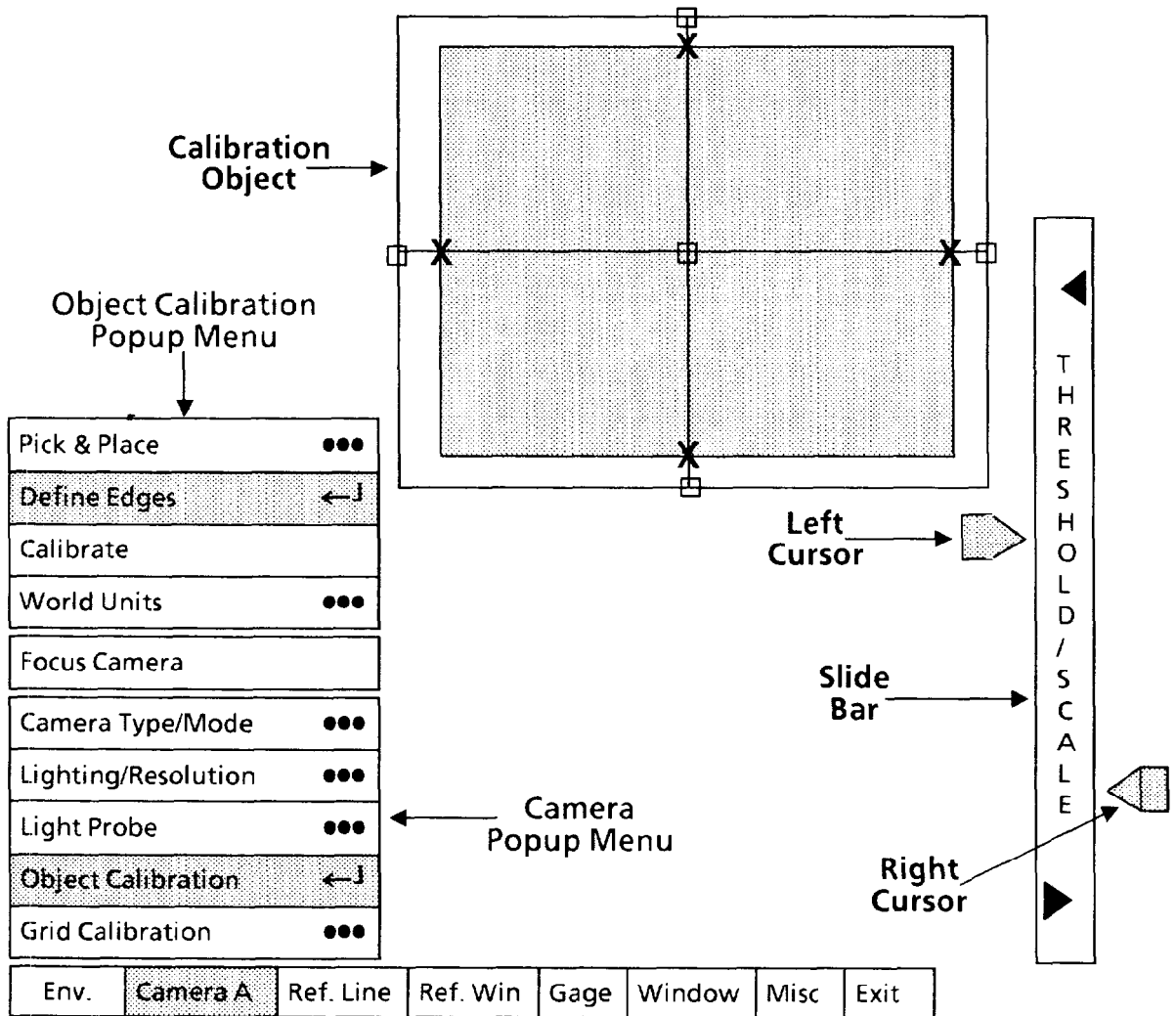

Pick and move each cursor until the X's are as shown.

Pick and move the cursors alternately until you see X's at the outer edges of the calibration object, as shown above.

Using trial and observation, you should try to find the most *stable* cursor positions; that is, positions that do not alter the X's when you move one cursor or the other up or down a small amount.

NOTE: Disregard any X's on either axis that lie *between* the edges of the calibration object. The system will ignore them.

Selecting Object Calibration Functions and Parameters
(continued)

Performing Calibrate Function

Perform the Calibrate function to calibrate the image to the edges on the calibration object.

NOTE: Before performing this function, be certain that the image resolution parameter is correct for your application. You should have selected that parameter earlier in this chapter in the *Selecting Resolution Popup Menu* section.

Your Action

Pick the Calibrate menu box in the Calibration popup menu.

Comments

When you pick the Calibrate menu box, the following message appears in the message box.

VERIFY EDGES: Select 'Verify Calibration' if the displayed edges correctly identify the target. Make any other selection to abort.

Note that the Calibrate menu box has changed to Verify Calibration. If X's are correctly positioned where the X and Y axes intersect the calibration object's edges, continue.

Pick the Verify Calibration menu box in the Calibration popup menu.

When you pick the Verify Calibration menu box, the CVIM system performs the calibration calculation.

Entering Calibration Object Dimensions

Select the World Units popup menu, then enter the actual edge-to-edge dimensions for the calibration object along its X- and Y-axes.

Your Action

Pick the World Units menu box in the Calibration popup menu.

Comments

When you pick the World Units menu box, a table will appear above the Calibration popup menu, as follows:

	X-Axis	Y-Axis
Pixels	86.835	53.710
Inches	86.8353 ●●●	53.7104 ●●●
Pixels/Inch	1.000	1.000

You will use this table to enter the X and Y dimensions of the calibration object. The numbers appearing in the table at this time are those that resulted when you performed the Calibrate function.

Selecting Object Calibration Functions and Parameters
(continued)

Entering Calibration Object Dimensions (continued)

Your Action

Comments

The table has three lines of numbers, which have the following meanings:

- **Pixels** – This line shows the value, in pixels, of the calibration window’s measurements along the X and Y axes.
- **Inches** – This is the *dimension* line. You use it to enter the X- and Y-axis dimensions of the calibration object along its X and Y axes. At this time, the line shows the same pixel-based values that are in the Pixels line, above.

NOTE: The word Inches reflects the “units” selection that you made in Chapter 4, *Operating Environment*. This word could be Pixels or CM instead of Inches.

- **Pixels/Inch** – This line displays the number of pixels per unit along the X and Y axes after you enter the calibration object dimensions in the dimension line. The CVIM system calculates this value by dividing the pixel-based value in the Pixels line by the value that you entered in the dimension line.

Pick the dimension box in the X-Axis column of the table.

When you pick this box, the calculator pad appears on the screen, as follows:

The interface consists of several components:

- Object Calibration Popup Menu:** A vertical list of options: Pick & Place, Define Edges, Calibrate, World Units (highlighted with a left arrow), Focus Camera, Camera Type/Mode, Lighting/Resolution, Light Probe, Object Calibration (highlighted with a left arrow), and Grid Calibration.
- Data Table:** A table with two columns (X-Axis, Y-Axis) and three rows (Pixels, Inches, Pixels/Inch).

	X-Axis	Y-Axis
Pixels	86.835	53.710
Inches	86.8353 ←	53.7104 ●●●
Pixels/Inch	1.000	1.000
- Calculator Pad:** A numeric keypad with a display showing '86.8353'. The keypad includes digits 0-9, a decimal point, and function keys: +, -, %, X, /, =, ←, Clr, and Enter.
- Status Bar:** A horizontal bar at the bottom with buttons: Env., Camera A (highlighted), Ref. Line, Ref. Win, Gage, Window, Misc, and Exit.

**Selecting Object Calibration
Functions and Parameters
(continued)**

Your Action

*Pick each digit of the
X-axis dimension of
the calibration object.*

Pick the Enter key.

*Pick the dimension box in the
Y-Axis column of the table.*

*Pick each digit of the
Y-axis dimension of
the calibration object.*

Pick the Enter key.

Entering Calibration Object Dimensions (continued)

Comments

As you pick each digit, it will appear in the calculator "display."

When you pick the Enter key, the X-axis dimension in the display will appear in the X-axis dimension box. At the same time, the CVIM system will calculate the pixels-per-unit ratio and display that in the box under the X-axis dimension box.

As you pick each digit, it will appear in the calculator "display."

When you pick the Enter key, the Y-axis dimension in the display will appear in the Y-axis dimension box. At the same time, the CVIM system will calculate the pixels-per-unit ratio and display that in the box under the Y-axis dimension box.

**Selecting Grid Calibration
Functions and Parameters**

Select the Grid Calibration popup menu, then select and configure the parameters and functions in that menu.

To use the Grid Calibration function, you will need to acquire an accurately crafted grid whose size and grid dimensions are suitable for your application.

As a general guide, the grid should be of a size and shape that enables you to see eight to sixteen squares across the screen image area in which the gage measurements are to be performed. The grid itself should be placed at the same distance from the camera as the parts to be inspected.

Grids can be purchased from scientific or optical equipment suppliers.

Selecting Grid Calibration Functions and Parameters
(continued)

Your Action

Pick the Grid Calibration menu box in the Camera popup menu.

Comments

When you pick the Grid Calibration menu box, the Grid Calibration popup menu appears above the Camera A (or B) popup menu, as follows:

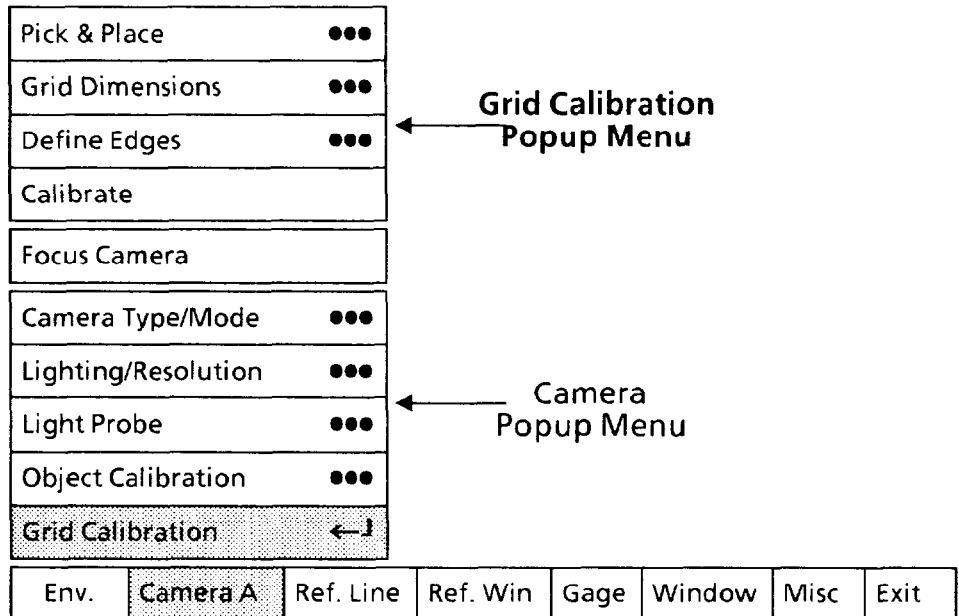

In addition to the Grid Calibration popup menu, the calibration window, with X and Y axes centered in it, will appear on the screen, as follows:

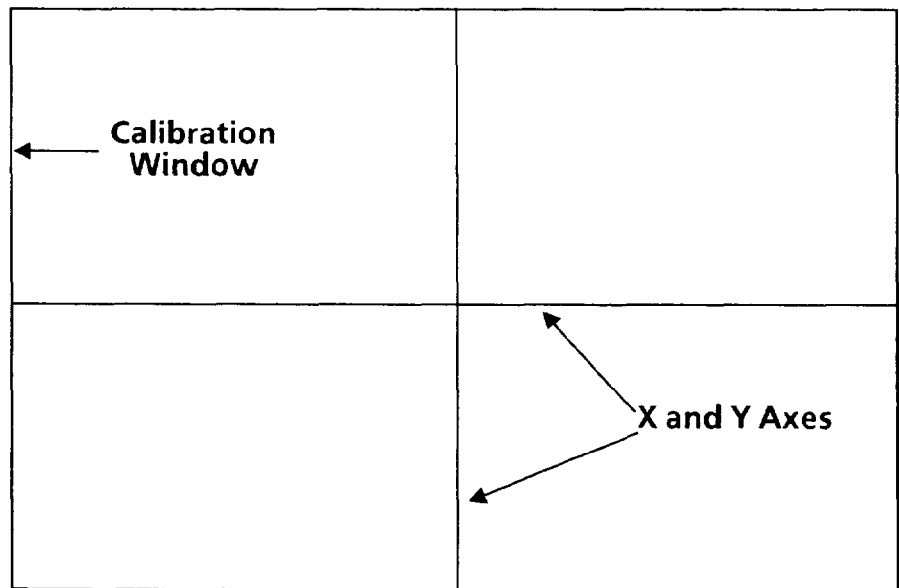

Selecting Grid Calibration Functions and Parameters
(continued)

Your Action

Using the Focus Camera function, correctly position the calibration grid in the screen image.

Comments

The calibration window and its axes are the screen symbols for the Grid Calibration function. You will use them to measure a "calibration grid" of known vertical and horizontal dimensions.

Before you continue, pick the Focus Camera menu box to generate a "live image" on the monitor screen. Position the calibration grid in the center of the screen so that it is aligned with the screen's X and Y axes.

Using Pick & Place Function

Select the Pick & Place function, then move the calibration window over the calibration grid and set the window to the appropriate size.

Your Action

Pick the Pick & Place menu box in the Calibration popup menu.

Comments

When you pick the Pick & Place menu box, five small squares, or "handles" will appear on the X and Y axes, as follows:

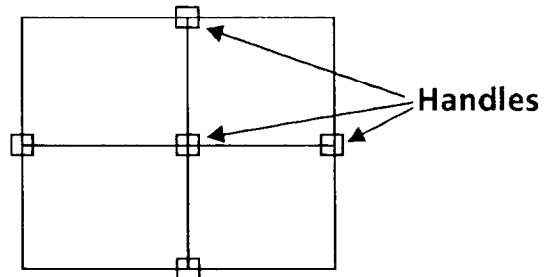

The light pen uses these handles to manipulate the calibration window on the screen image.

Aim the light pen at the center handle.

Move the light pen around slightly as you aim it at the center handle. At some position of the pen you will see a larger square surrounding the handle, as follows:

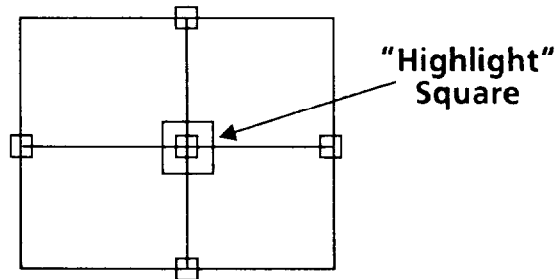

Hold the pen steady in this position – the appearance of the larger square means that the light pen is now properly aimed.

**Selecting Grid Calibration
Functions and Parameters**
(continued)**Using Pick & Place Function (continued)****Your Action**

*Press the light pen against
the squares.*

Comments

Press the pen firmly against the squares on the screen, then release it. A small "X" will appear in the center of the window, and the handles will disappear, as follows:

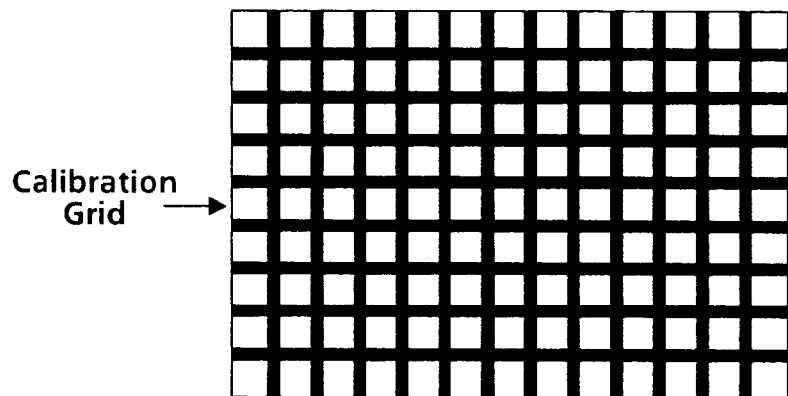
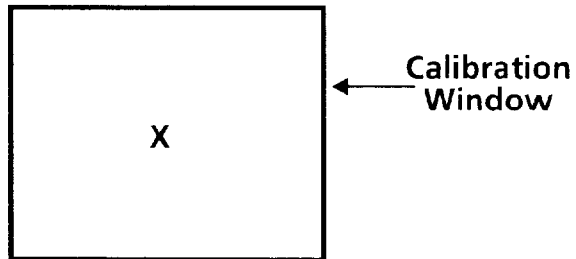

This indicates that you can now move, or "drag," the window toward the calibration grid on the monitor screen.

Selecting Grid Calibration Functions and Parameters
(continued)

Using Pick & Place Function (continued)

Your Action

Drag the calibration window over the calibration grid.

Comments

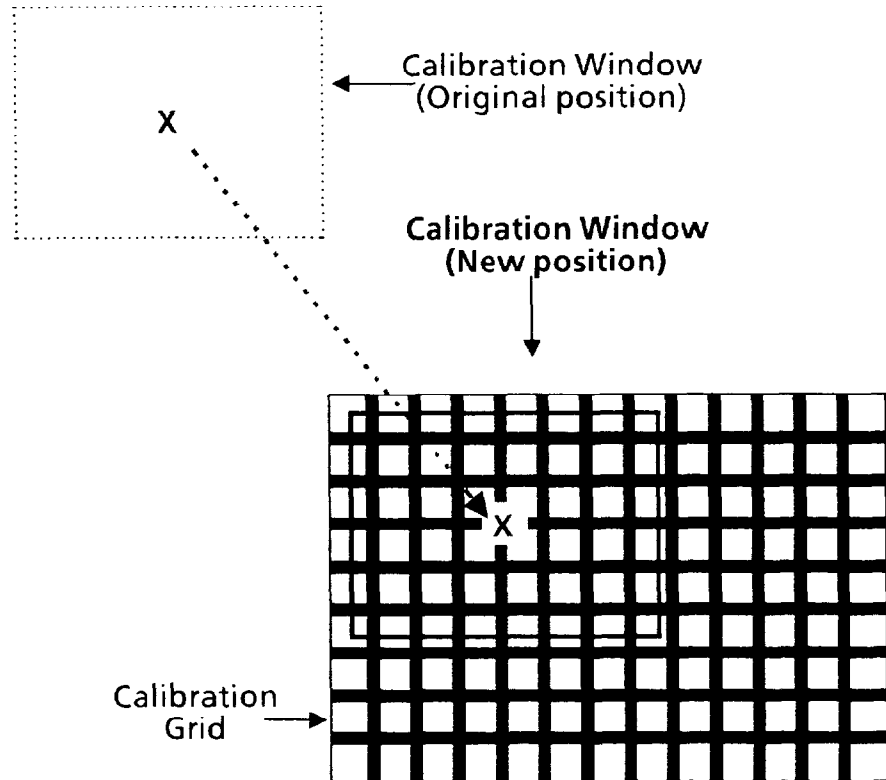

When you have dragged the window into position, press the light pen tip against the screen to "lock" the window at that position.

Aim the light pen at the rightmost handle.

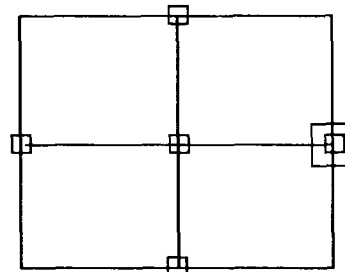

Selecting Grid Calibration Functions and Parameters
(continued)

Using Pick & Place Function (continued)

Your Action

Comments

Pick the handle.

Drag the right side until it is just inside the grid.

Note that the *left* side remains anchored.

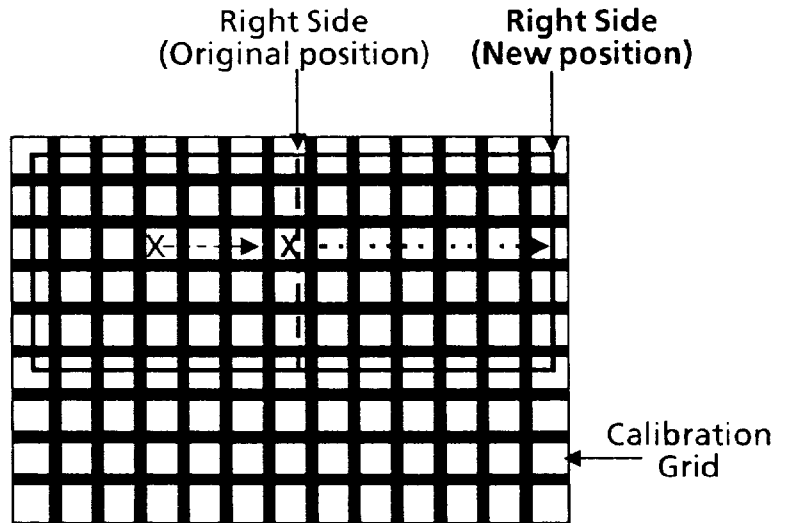

“Lock” the window’s right side in position.

Aim the light pen at the bottom handle.

Continue when the highlight square appears.

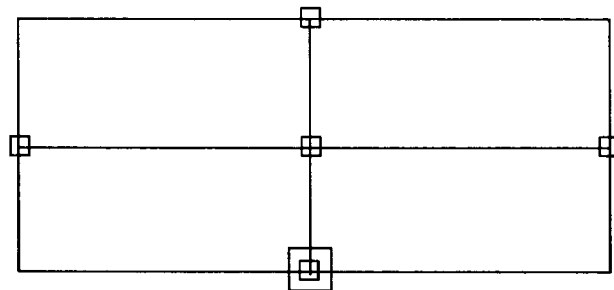

Pick the handle.

Selecting Grid Calibration Functions and Parameters (continued)

Using Pick & Place Function (continued)

Your Action

Drag the bottom side until it is just inside the grid.

Comments

Note that the *top* side remains anchored.

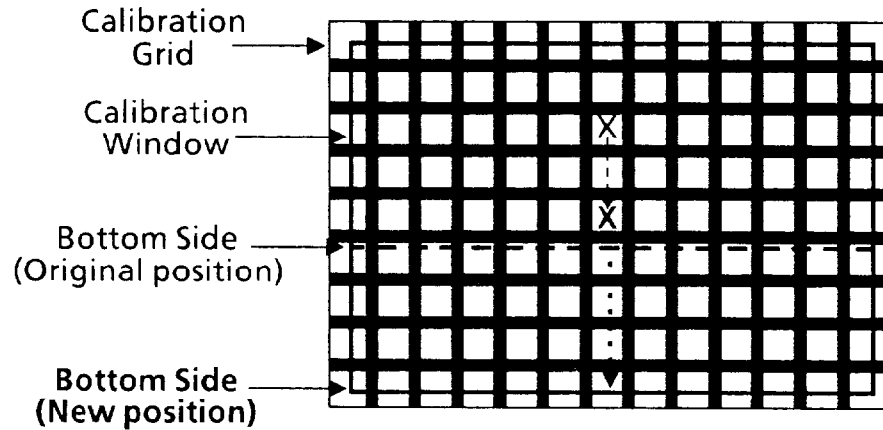

Lock the window's bottom side in position.

At this point, you have adjusted the window's position and size so that it is just inside the calibration grid.

The X and Y axes should look like this:

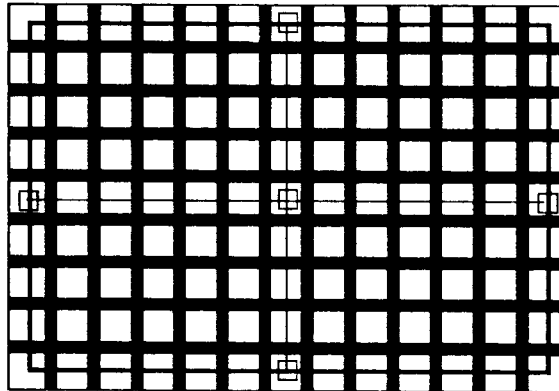

Note that all of the edges along the X and Y axes will be *inside* the calibration grid.

Selecting Grid Calibration Functions and Parameters (continued)

Using Pick & Place Function (continued)

Your Action

If necessary, use the vernier arrows to "fine-tune" the position or size of the window.

Press and hold the light pen tip against the window handle, window, or side.

Comments

You can position the calibration window and its sides more *precisely* by using the *vernier* arrows. These arrows enable you to move the window or window sides in small increments.

You can access the vernier arrows while either *picking* a window handle or *placing* the window or one of its sides.

Hold the light pen tip in for about *one second*. The vernier arrows will then appear in the lower-right corner of the monitor screen:

VERNIER ARROWS

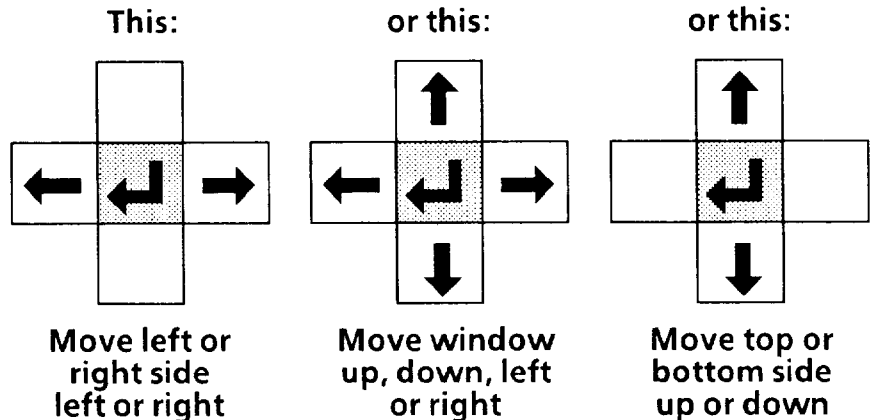

Pick an arrow once to move the window or window side one pixel in the arrow's direction.

Pick and hold an arrow to change the window size or position continuously.

Pick the "return" symbol to release the vernier arrows.

The up, down, right, or left arrow will move the entire window or window side *one pixel* in the direction indicated by the arrow.

When you pick and *hold* an arrow, the window's size or position will change slowly for the first five or six increments. It will then change at a more rapid rate.

When the window's size and/or position are correct, pick the "return" symbol (←┘) to *release* the vernier arrows and return to the pick-and-place mode.

Selecting Grid Calibration Functions and Parameters
(continued)

Defining Edges

Select the Define Edges menu box, then adjust the threshold/scale adjustment cursors until an X appears on each side of each black line and on each outer edge of the calibration grid along the X and Y axes.

Your Action

Comments

Pick the Define Edges menu box in the Calibration popup menu.

When you pick the Define Edges menu box, numerous X's may appear along the axes, and a slide bar will appear at the right side of the screen, as follows:

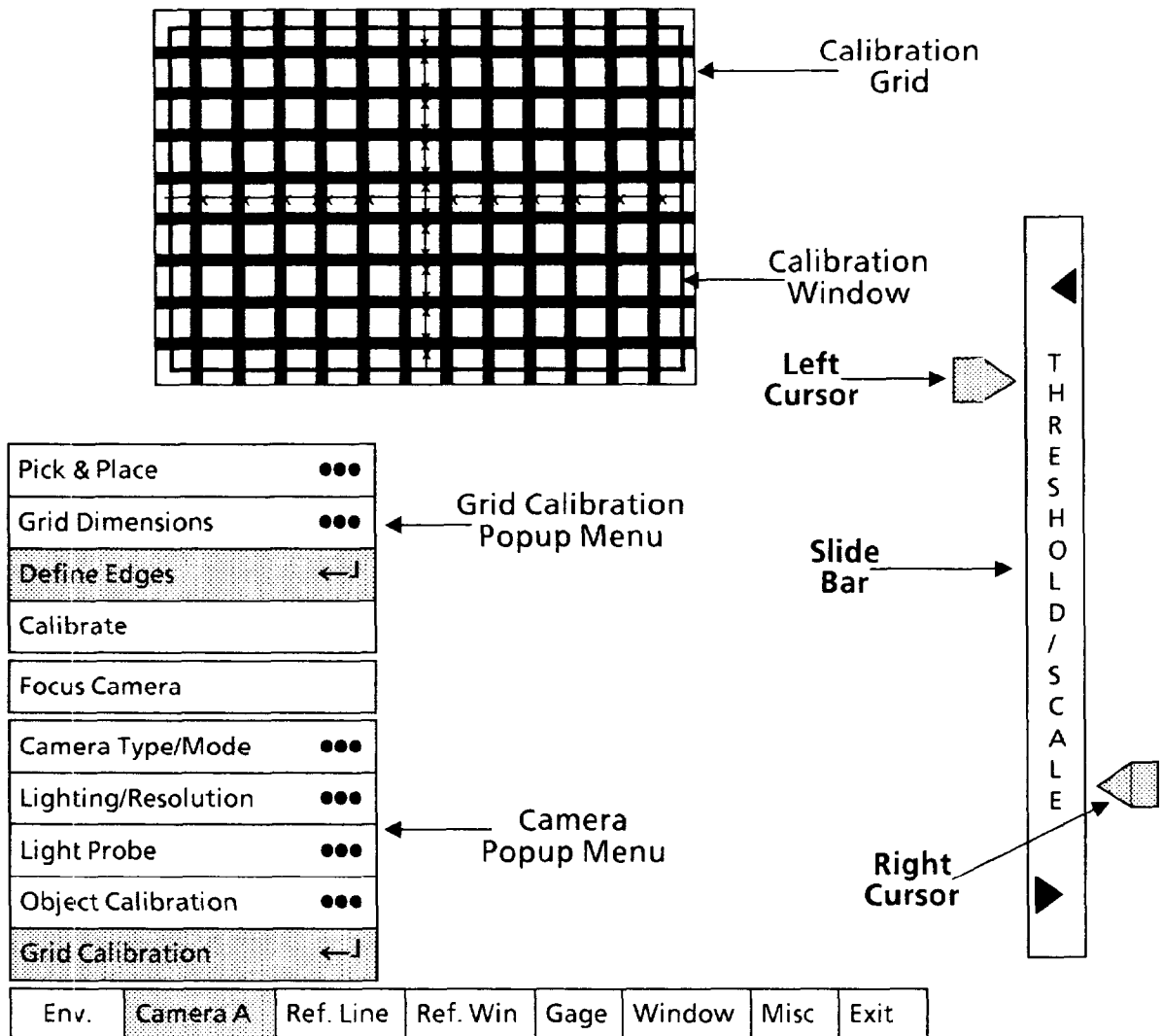

Selecting Grid Calibration Functions and Parameters
(continued)

Defining Edges (continued)

Your Action

Pick and move each cursor until the X's are as shown.

Comments

Pick and move the cursors alternately until you see an X on both sides of each square along the X and Y axes, as shown in the preceding figure and in the following magnified view of the center section of the calibration grid:

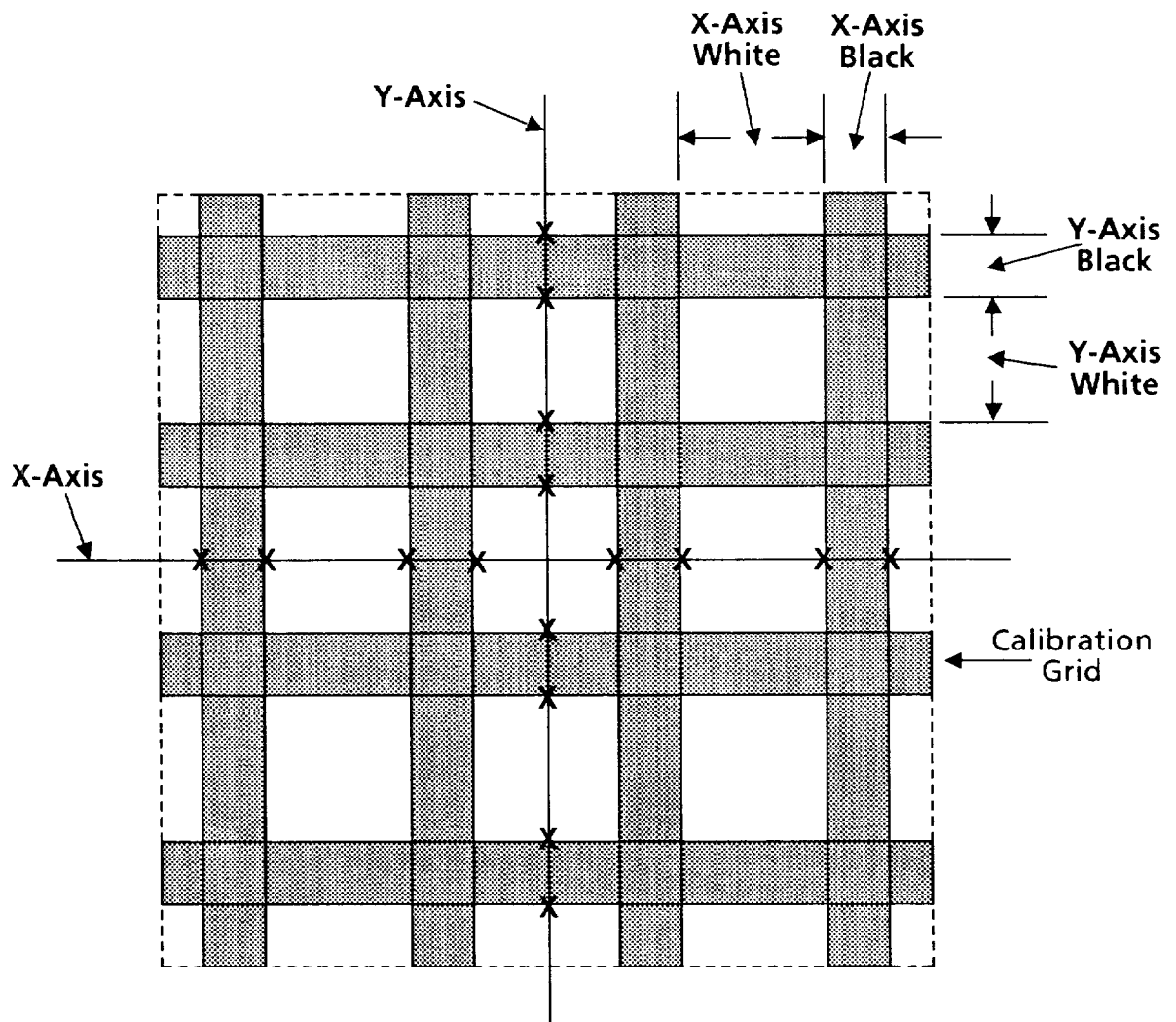

Using trial and observation, try to find the most *stable* cursor positions; that is, positions that do not alter the X's when you move one cursor or the other up or down a small amount.

Selecting Grid Calibration Functions and Parameters (continued)

Entering Calibration Grid Dimensions

Select the Grid Dimensions popup menu, then enter the actual edge-to-edge dimensions of the white and black areas that the X and Y axes cross.

NOTE: Grid dimensions are supplied with the grid.

Your Action

Pick the Grid Dimensions menu box in the Grid Calibration popup menu.

Comments

When you pick the Grid Dimensions menu box, the Grid Dimensions popup menu will appear alongside the Grid Calibration popup menu, as follows:

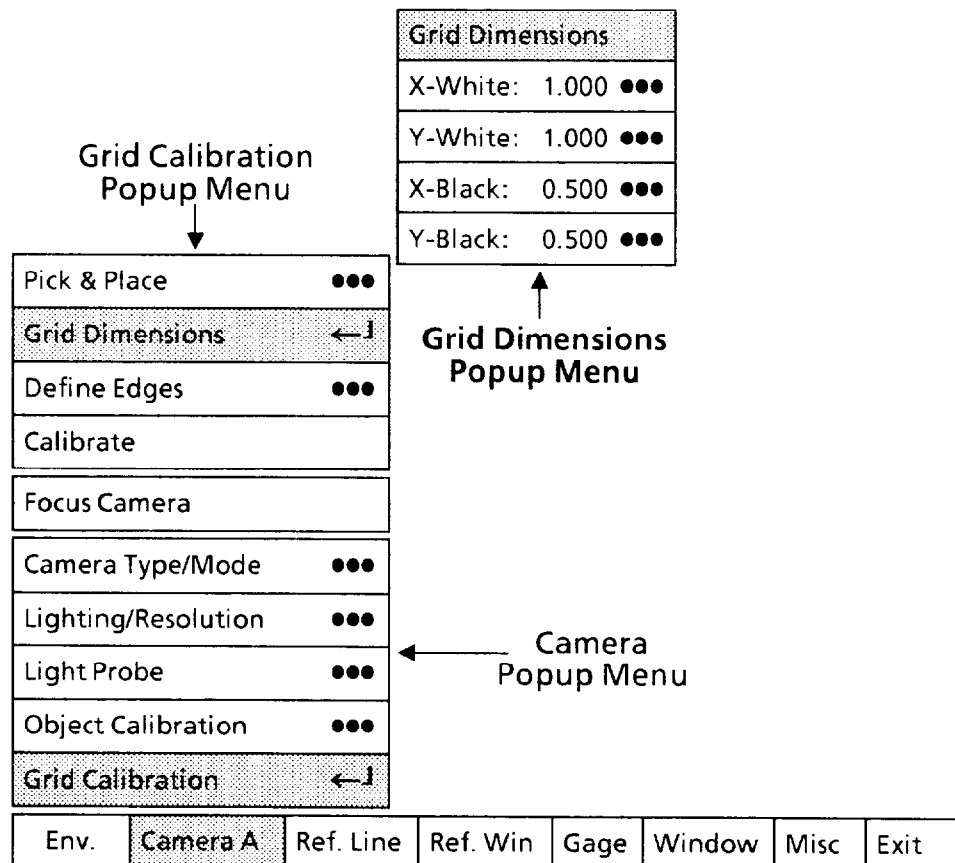

You will use the Grid Dimensions popup menu to enter the edge-to-edge dimensions of the white and black areas along each axis. The numbers appearing in the menu at this time are either the default values or are those that were entered previously.

The Grid Dimensions popup menu has four boxes, which have the following meanings:

- X-White – This box shows the current value, in “world” units, of the dimension across each *white* area of the calibration grid along the X axis.
- Y-White – This box shows the current value, in “world” units, of the dimension across each *white* area of the calibration grid along the Y axis.

Selecting Grid Calibration Functions and Parameters
(continued)

Entering Calibration Grid Dimensions (continued)

Your Action

Comments

Pick the X-White box in the Grid Dimensions menu.

● X-Black – This box shows the current value, in “world” units, of the dimension across each *black* area of the calibration grid along the X axis.

● Y-Black – This box shows the current value, in “world” units, of the dimension across each *black* area of the calibration grid along the Y axis.

When you pick the X-White box, the calculator pad appears alongside the Grid Dimensions popup menu, as follows:

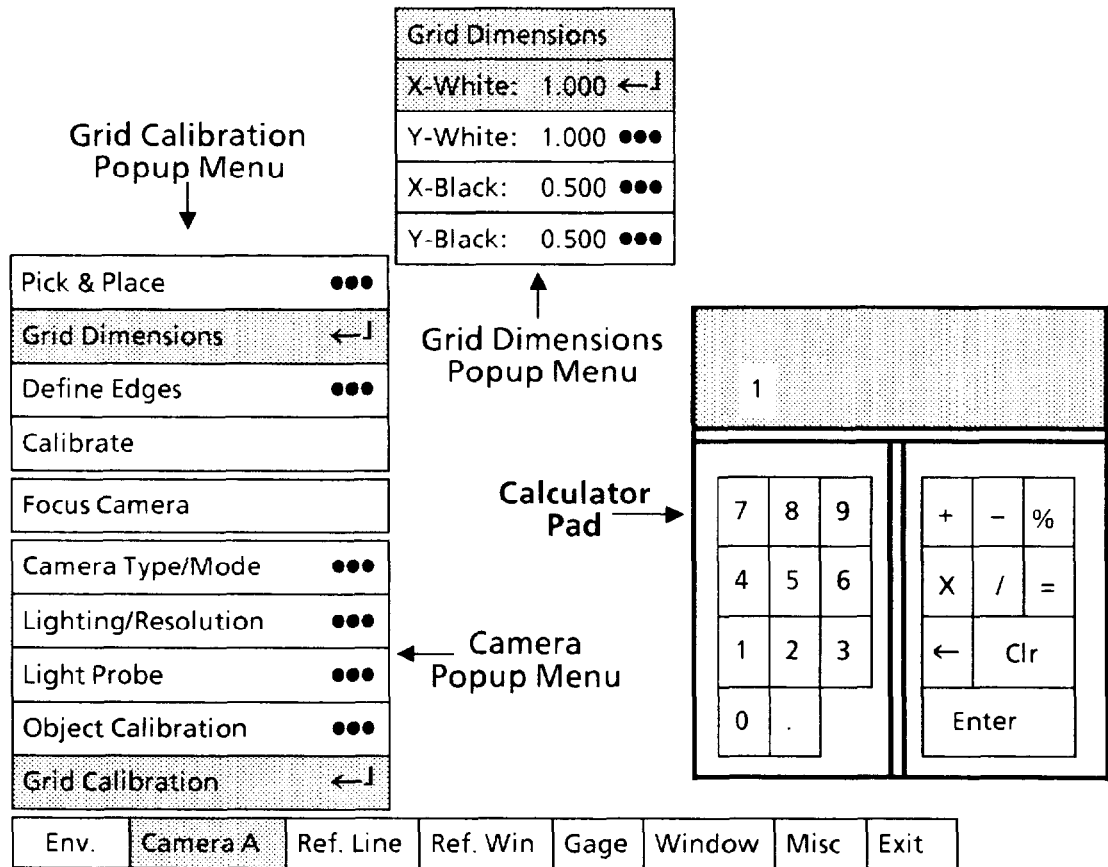

Pick each digit of the X-White dimension of the calibration grid.

Enter the actual dimension of the *white* area in the calibration grid along the X axis, as shown in the preceding magnified view of the grid. As you pick each digit, it will appear in the calculator display.

Pick the Enter key.

When you pick the Enter key, the X-White dimension in the display will appear in the X-White dimension box.

Repeat the last two steps for the Y-White, X-Black, and Y-Black grid dimensions.

Enter each of the other three grid dimensions.

Selecting Grid Calibration Functions and Parameters (continued)

Performing Calibrate Function

Perform the Calibrate function to calibrate the image to the edges on the calibration grid.

NOTE: Before performing this function, be certain that the image resolution parameter is correct for your application. You should have selected that parameter earlier in this chapter in the *Selecting Resolution Popup Menu* section.

Your Action

Pick the Calibrate menu box in the Calibration popup menu.

Comments

When you pick the Calibrate menu box, a series of small squares will appear in the upper-left corner of each grid square, as follows:

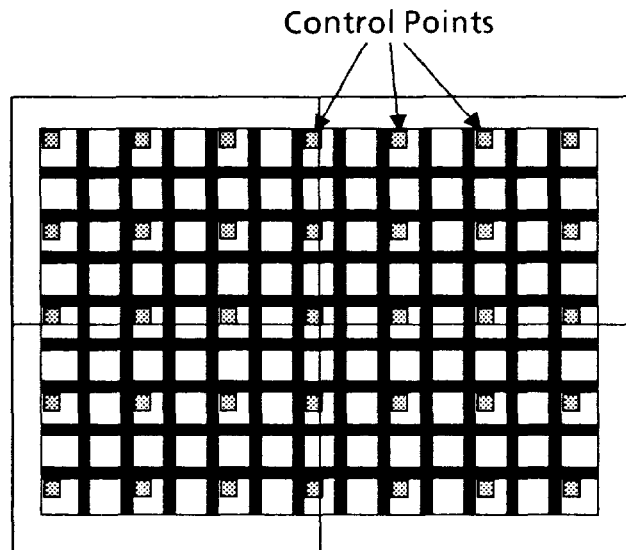

These are called “control points,” and they indicate whether the CVIM system “found” grid square corners everywhere that it expected to find them.

NOTE: Along each axis, the system will display control points according to the following conditions:

- A control point in every square if the axis crosses fewer than eight grid squares.
- A control point in every *other* square if the axis crosses more than eight grid squares.
- A control point in every *third* square if the axis crosses more than sixteen grid squares.

**Selecting Grid Calibration
Functions and Parameters**
(continued)

Performing Calibrate Function (continued)

Your Action

Comments

If the system fails to find a grid square corner, it will stop displaying the control points, and the following message will appear in the message box:

**ERROR: A grid square was not found
where one was expected.**

If this occurs, check the grid carefully for defective squares.

If the system finds *all* control points, the following message will appear in the message box:

**VERIFY CONTROL POINTS: Select 'Verify
Calibration' if the control points are correct.
Make any other selection to abort.**

Note that the Calibrate menu box has changed to Verify Calibration. If X's are correctly positioned where the X and Y axes intersect the calibration object's edges, continue.

*Pick the Verify Calibration
menu box in the Grid
Calibration menu.*

When you pick the Verify Calibration menu box, the CVIM system performs the calibration calculation.

At this point, the CVIM system is configured to perform measurements in "world" units.

Chapter 6 Reference Tools: Lines and Windows

Chapter Objectives

The objectives of this chapter are first to show you how reference tools can be used, and then show you the procedure for configuring them. The chapter begins with a series of questions and answers about reference tools.

A Few Questions and Answers About Reference Tools

This section introduces you to reference tools by asking a few questions that might occur to you, and then answering those questions.

What is a reference tool?

A reference tool is a pre-inspection tool that examines the *position* of each workpiece and determines whether it is shifted relative to the position of the “original” workpiece. If so, the CVIM system can calculate the amount of shift and apply shift compensation to other tools.

What kinds of reference tools are there?

The CVIM system provides two types of reference tools: *lines* and *windows*.

How do these tools work?

- A reference *line* searches along its length for specific *edges* on a workpiece. It can search horizontally (X-axis), vertically (Y-axis), or both.
- A reference *window* searches within its boundary for a specific *feature* on a workpiece.

How many reference lines and windows are there?

- The CVIM system provides three sets of reference lines for each of its two tool sets. Each set contains one, two, or three lines, according to the specific function.
- The CVIM system provides three sets of reference *windows* for each of its two tool sets. Each set contains three feature/search window pairs.

What functions does a reference tool perform?

A reference tool’s main functions are to:

- Locate an edge or feature on each new workpiece entering the camera’s field of view during an inspection cycle.
- Check for shift and/or rotation in the position of each new workpiece relative to the position of the *original* workpiece.
- Measure and record the shift direction and amount.
- Use the recorded shift and/or rotation information to shift the position of all associated analysis tools so that they retain correct alignment with the shifted workpiece.

A Few Questions and Answers About Reference Tools
(continued)

When might a reference tool be necessary?

A reference tool might be needed if, during a normal series of inspections, successive workpieces are not likely to be in *exactly* the same position from inspection to inspection, but are expected to *vary* in position (but always *within* the camera's field of view)

What kinds of shift compensation information can reference tools detect?

- Each set of reference lines can detect workpiece shift along the X and/or Y axes and rotation up to ± 60 degrees.
- Each set of reference windows can detect workpiece shift along the X and Y axes and rotation up to ± 15 degrees.

What is the relationship of a reference tool to an inspection tool?

A reference tool exists mainly to supply shift and/or rotation compensation to one or more inspection tools. You can configure any inspection tool to receive shift and/or rotation information from any reference tool.

How does the CVIM system make use of shift and/or rotation information from a reference tool?

The CVIM system uses shift and/or rotation information from a particular reference tool to adjust the positions of all inspection tools associated with that reference tool.

Reference Lines

This section provides you with the details of using and configuring reference lines.

Under the *Using Reference Lines* heading, you will see a simple example application in which a reference line provides shift compensation for a linear gage configured to measure the level of liquid in a bottle.

Under the *Configuring Reference Lines* heading, you will use the CVIM "user interface" – the light pen, popup menus, and graphic symbols on the video monitor screen – to configure a reference line.

Using Reference Lines

The following pages describe how you can use reference lines to detect and measure workpiece shift and offset the inspection tools by the amount of the shift. This process is called "shift compensation," and its advantage is that workpieces need *not* be rigidly fixtured for inspection.

Reference lines can compensate for workpiece shift along the horizontal axis only, or the vertical axis only, or along both axes at the same time.

Using Reference Lines
(continued)

In the following example of using a reference line, these are the assumptions:

- The workpiece is a clear glass bottle filled with an opaque liquid, such as hand lotion.
- The bottle is backlighted.
- The CVIM system will use a linear gage to measure the level of the liquid.
- The position of each bottle being inspected will vary *horizontally* from the “original,” but not *vertically*.
- The CVIM system will use a *horizontal* reference line to provide shift compensation to the linear gage.

The overall objective in this example is for the CVIM system to inspect every bottle for proper fill level and to reject all bottles that are not properly filled.

The functions of the reference line in this example are these:

- Find the bottle within a preset range along the X-axis. (NOTE: The “preset range” is determined by the *position* and *length* of the reference line.)
- Check each inspected bottle to determine whether it is *shifted* from the position of the “original” bottle.
- If an inspected bottle is shifted, shift the linear gage by the same amount, and in the same direction, as the bottle.

Figure 6.1 shows how an image of a properly filled bottle might look on your monitor screen. Since both the liquid and the bottle cap are opaque, they should appear black when lighted from behind. Under the same backlighting conditions, the semi-transparent neck (above the liquid) should appear as a light shade of gray.

Figure 6.1 also shows a horizontal reference line positioned on the bottle. (During configuration, you would have moved the line to this position.) If you consider this bottle to be in the “original” position, the X marks the “original” location of the bottle’s edge on the reference line.

As the CVIM system inspects a series of bottles, the reference line will find the edge on any bottle as long as that edge lies somewhere along the reference line. (During configuration, you would have set the reference line’s length equal to the maximum allowable shift in the bottle’s position.)

If a particular bottle is shifted, but its edge lies *somewhere* on the reference line, the reference line will find the edge. If, however, the bottle has shifted so much that its edge lies *beyond* either end of the reference line, an inspection failure will occur since the reference line will *not* find the bottle’s edge.

Using Reference Lines (continued)

Figure 6.1 Reference Line Positioned Across Bottle

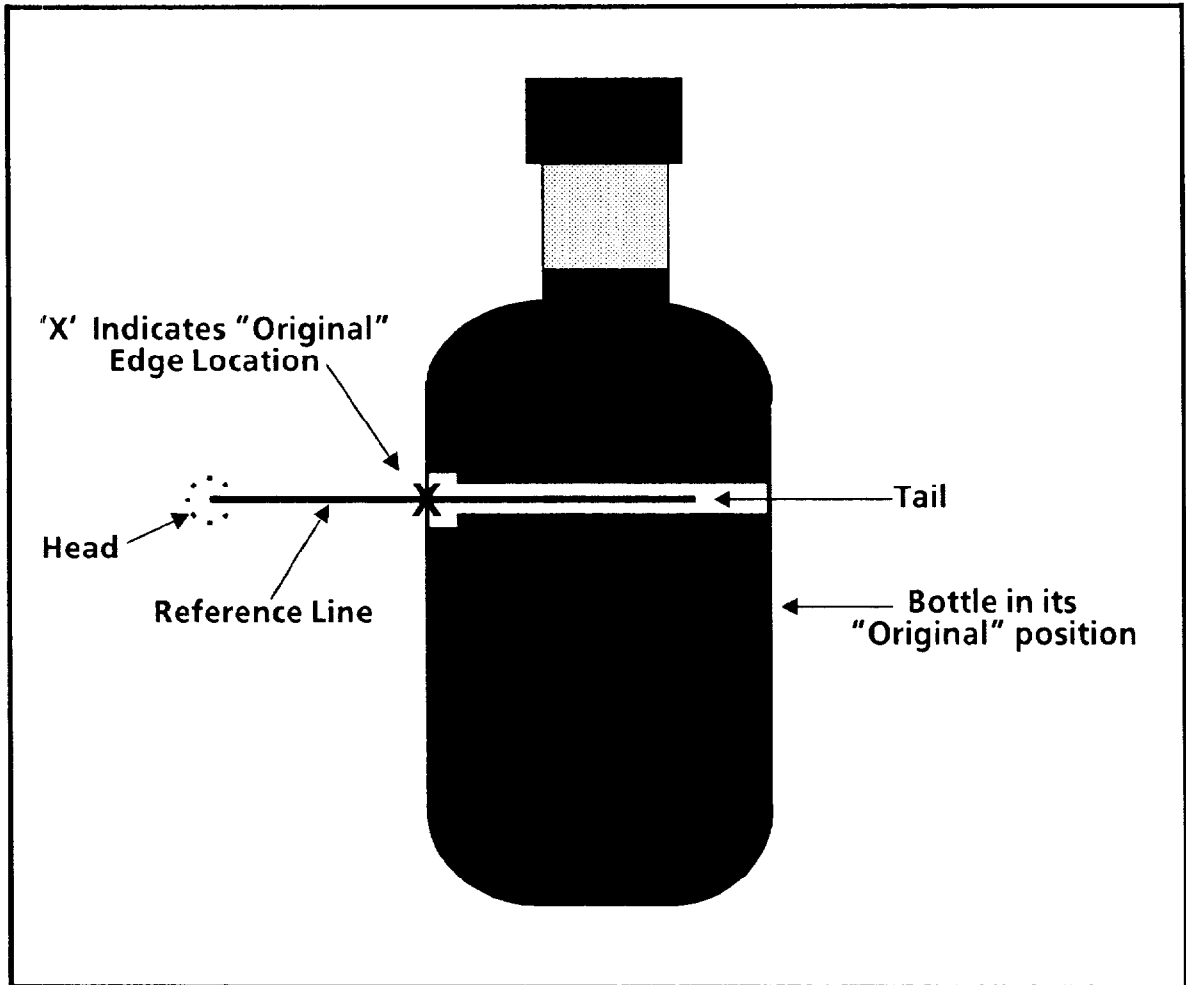

If the CVIM system did not have some way to compensate for the bottle's horizontal shift, an inspection could fail because the gage may not coincide with the bottle's neck.

To summarize the factors in the bottle inspection example:

- A horizontal reference line will be configured to *find* the bottle.
- A linear gage will be configured to *measure* the liquid level in the bottle.
- The bottles in any series of inspections will be shifting *horizontally*.
- These horizontal shifts will always occur *within* the length of the reference line.
- All bottles will be in the *same* position *vertically*.

Using Reference Lines
(continued)

Figure 6.2 shows how a linear gage might appear when positioned vertically over the bottle's neck. The gage length need only be sufficient to extend below the *lowest* acceptable liquid level. At that length, the gage would also be able to detect the *highest* acceptable level.

One way to measure the liquid level is to have the gage measure the distance from the top of the cap to the liquid surface. You could set an upper and lower limit for the level, and have CVIM reject any bottle whose level is above or below those limits.

Figure 6.2 Linear Gage Positioned Vertically Over Bottle

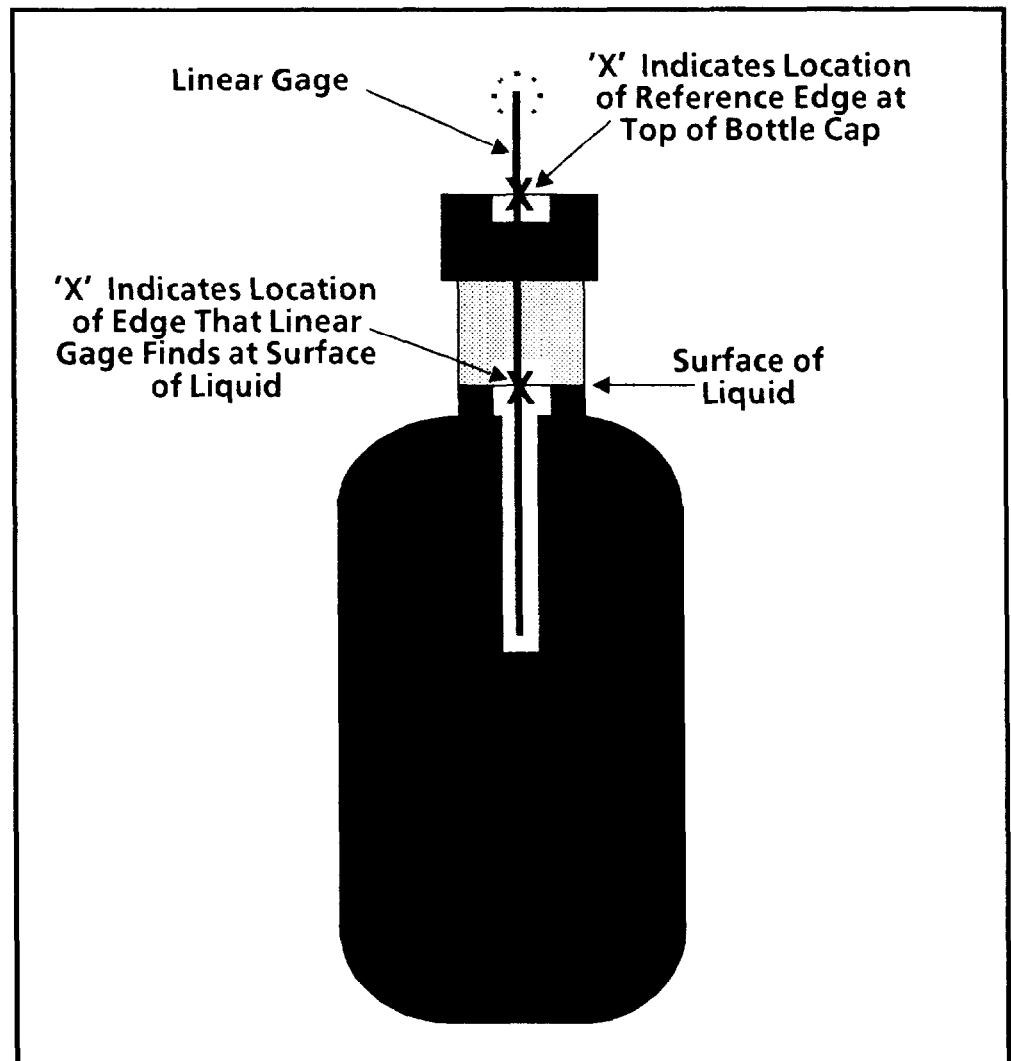
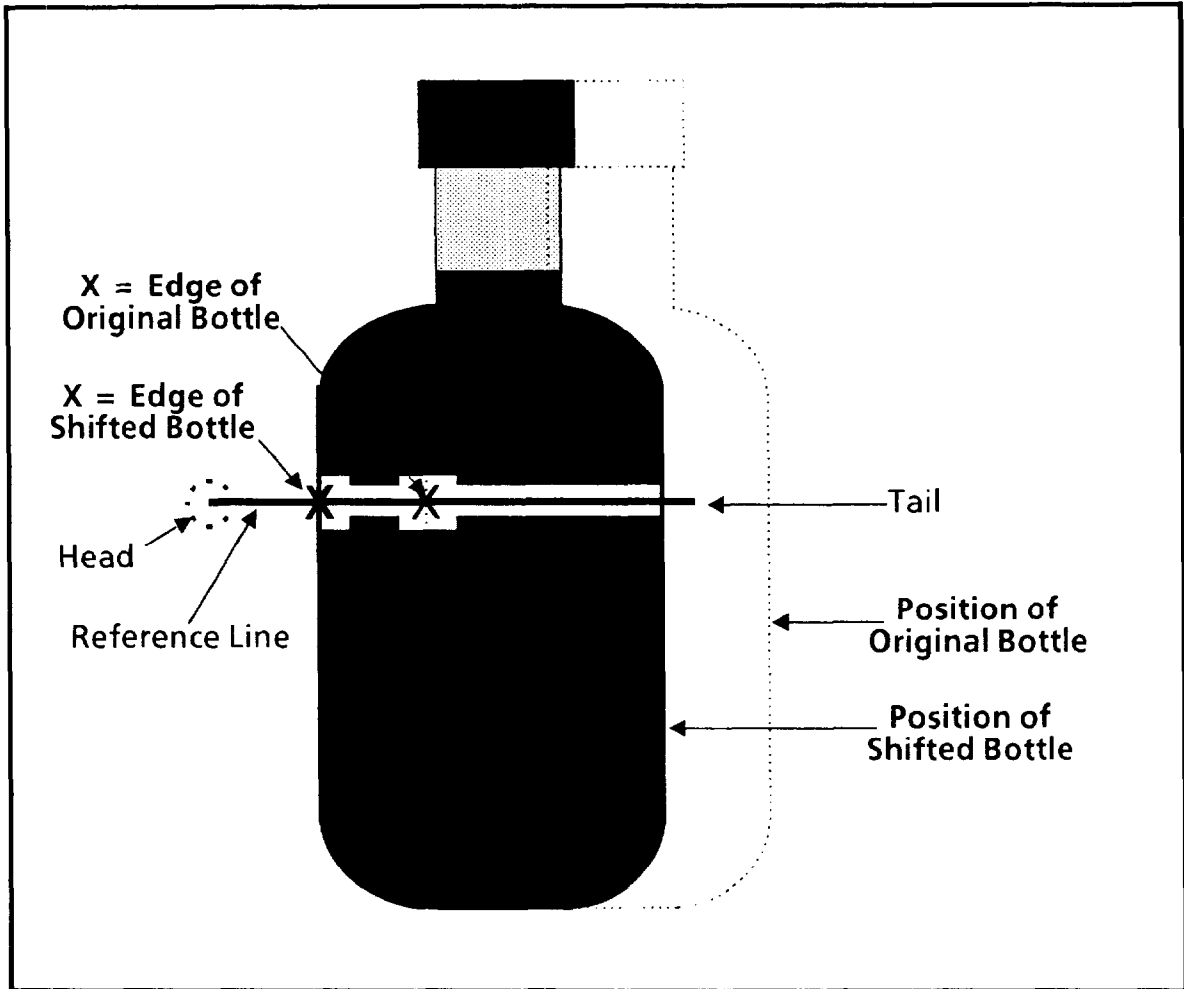

Figure 6.3 compares the position of the "original" bottle (the one you used to configure the reference line) to the position of a *shifted* bottle (one that appears during an inspection). The X's show the respective edge positions along the reference line.

Using Reference Lines (continued)

Figure 6.3 Edge Locations on Shifted Bottle and Original Bottle



At the start of each inspection, the reference line searches along its length for the bottle's edge. It starts the search at its head (the circle) and proceeds rightward toward its tail until it detects the edge of the bottle. It expects to find that edge *somewhere along its length*.

When the reference line finds the shifted bottle's edge, the position of *that* edge is compared with the position of the *same* edge on the "original" bottle. The difference between the two edge positions is the amount of horizontal shift compensation applied to the linear gage.

Using Reference Lines
(continued)

For instance, assume that the reference edge of the *original* bottle was at X-axis pixel location 120 along the reference line, and the linear gage was at X-axis location 150. Assume also that the reference line found the edge of the *shifted* bottle at pixel location 105, which is 15 pixels to the *left* of the original edge (pixel numbers increase, left-to-right).

The CVIM system compensates for the shifted bottle by shifting the linear gage 15 pixels to the *left*, thus repositioning the gage over the bottle's neck. Figure 6.4 shows this. The system then proceeds with the linear gage measurement on the liquid level of the *shifted* bottle.

Look again at Figure 6.4. Notice that *without* shift compensation, the linear gage would be to the *right* of the bottle's neck. In this particular case, the gage would probably indicate (falsely) a too-low liquid level.

Figure 6.4 Linear Gage After Shift Compensation

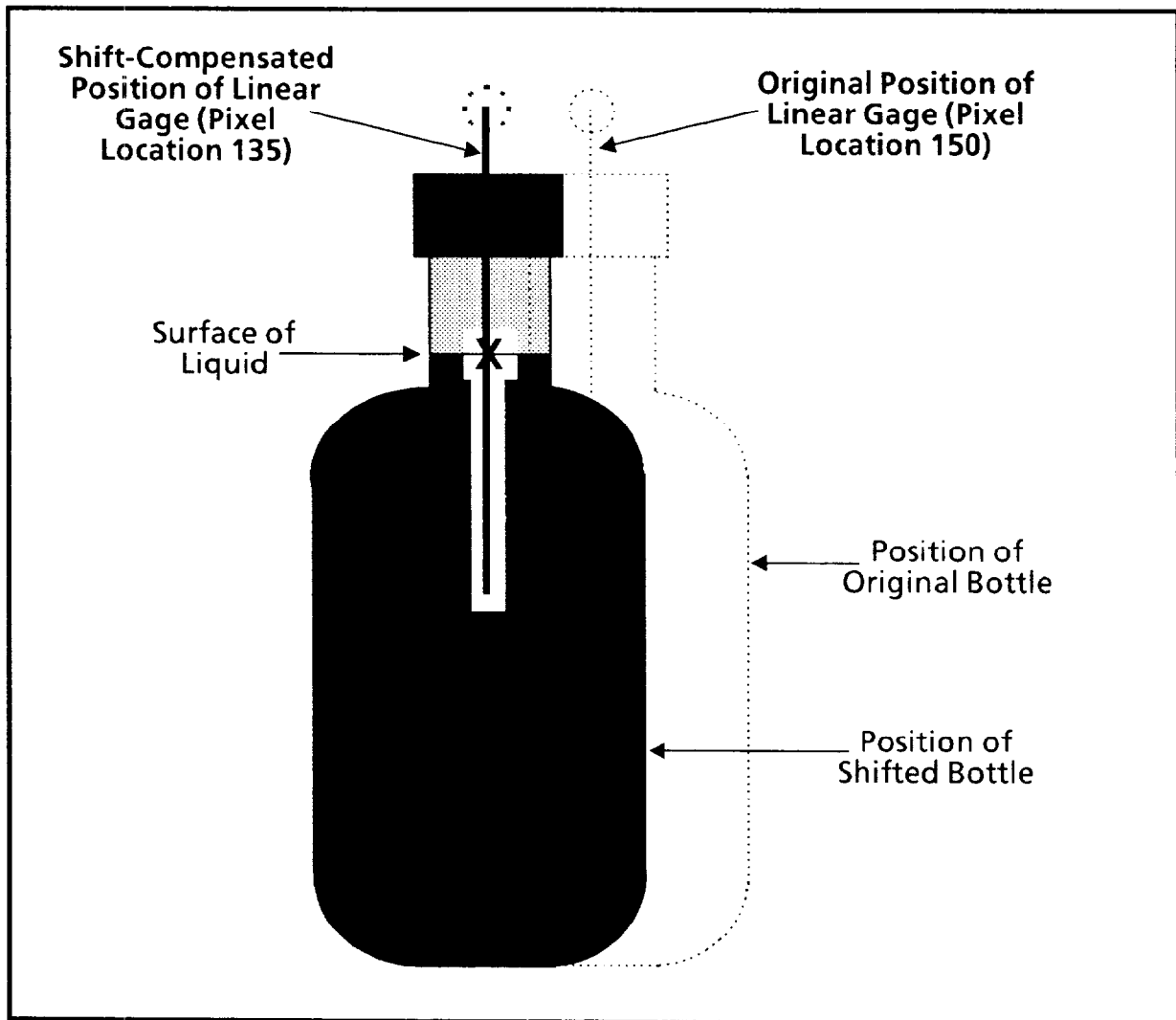

Using Reference Lines (continued)

The purpose of the bottle inspection example was to give you simple demonstration of using a reference line.

In actual applications, three sets of reference lines are available. Within each set, you can use the horizontal and vertical lines either in pairs or singly. Each set can provide shift compensation for inspection gages and/or windows.

In addition, the reference lines can provide shift and/or rotation compensation for other reference tools, with the following restrictions:

- A reference line cannot provide shift and/or rotation compensation to a *lower* numbered reference line. Thus, reference line #2 cannot be a reference tool for reference line #1.
- A reference *window* cannot provide shift or rotation compensation to a reference *line*.

Configuring Reference Lines

To configure the reference lines, you will pick the Ref. Line menu box in the Main Configuration menu then select the parameters and perform the functions in the Ref. Line popup menu.

These are the main function and configuration categories in the Ref. Line popup menu:

- **Reference line definition:** Sets the reference line position and length. Selects the line type, the line to be configured, and binary or gray scale mode. Defines the edges.
- **Reference line features:** Selects the *specific* edge to be used for the X and/or Y line.
- **Select output lines and reference tool:** Selects the output line for reporting inspection "results," and selects reference tool from which to receive shift compensation.
- **Learn edge references:** This function "learns" the pixel location of the edge on the X and/or Y reference line.
- **Select reference line set:** This function selects the reference line set (1, 2, or 3) to be configured.
- **Enable/disable reference line set:** This function enables or disables the currently selected reference line set.

Configuring a set of reference lines involve these basic steps:

- Selecting the reference line set (1 to 3) to be configured.
- Enabling the selected reference line set.
- Positioning and sizing the reference line(s) over the workpiece.
- Selecting either a binary or gray scale image in which to search for the edge.
- Defining and selecting the particular edge(s).

Selecting Ref.Line Popup Menu

Your first step is to select the Ref. Line popup menu.

Your Action**Comments**

Pick Ref.Line in the Main Configuration menu.

When you pick the Ref.Line menu box, the Ref. Line popup menu appears above the Main Configuration menu, as follows:

Define Ref.Line		●●●
Define Features		●●●
Output/Reference		●●●
Learn: X.Ref = 0 Y.Ref = n/a		← Ref. Line Popup Menu
Ref.Line 1: Enabled		
Previous	Next	

Env.	Camera A	Ref. Line	Ref. Win	Gage	Window	Misc	Exit
------	----------	-----------	----------	------	--------	------	------

The Ref. Line popup menu shows the six configuration categories described earlier.

In addition to the Ref.Line popup menu, if the currently selected reference line is *enabled*, as shown above, that line will also appear somewhere on the monitor screen.

Selecting and Enabling Reference Line

Select a reference line number and enable the reference line.

Your Action**Comments**

Look at the Ref.Line menu box in the Ref.Line popup menu.

The Ref.Line menu box indicates the currently selected reference line number (1, 2, or 3), and indicates the reference line status: Enabled or Disabled.

Select the reference line number.

To change the reference line number, pick the Next (or Previous) menu box repeatedly until the correct number appears.

The Next and Previous functions work like this: When you pick the Next box, the next *higher* reference line number appears: 1, 2, 3, . . . 1, 2, 3, and so on. When you pick the Previous box, the next *lower* reference line number appears: 3, 2, 1, . . . 3, 2, 1, and so on.

Look at the Ref.Line menu box again.

If the status is Disabled, perform the next step.

Pick the Ref.Line menu box.

To *enable* the reference line, pick the Ref.Line menu box. The status should now indicate Enabled.

**Selecting Define Ref.Line
Popup Menus and
Parameters**

Select the Define Ref.Line popup menus, then select the parameters in those menus.

Your Action

Comments

Pick the Define Ref.Line menu box in the Ref.Line popup menu.

When you pick the Define Ref.Line menu box, the two Define Ref. Line popup menus appear above the Ref.Line popup menu, as follows:

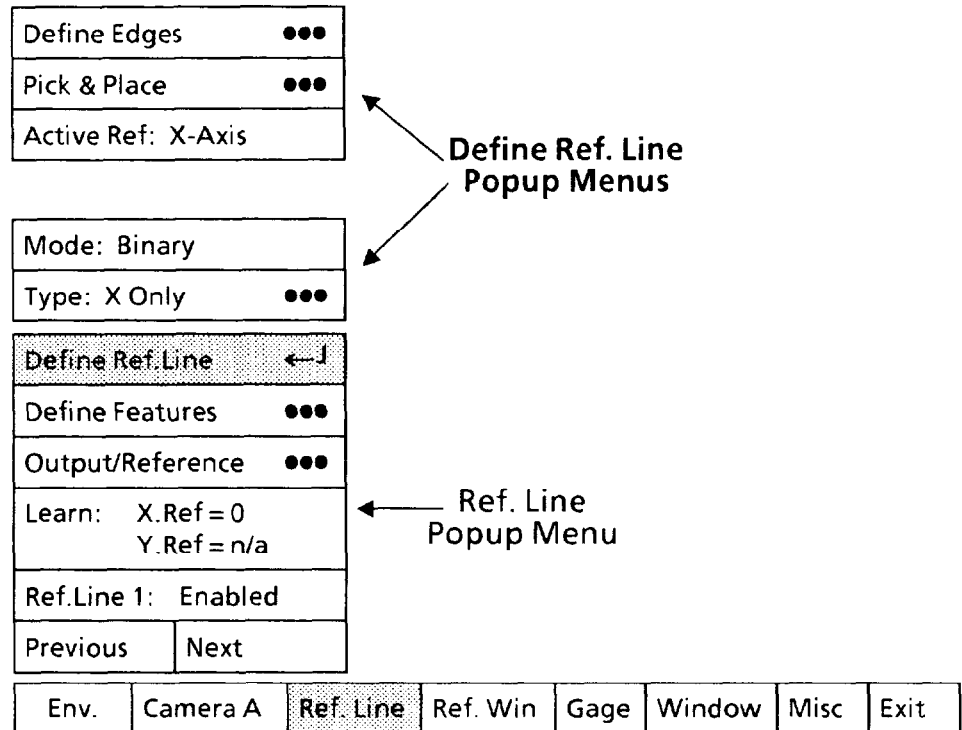

Selecting Ref.Line Type Popup Menu

Select the Ref.Line Type menu box, then select one of the six reference line types, as follows:

1. X-axis line only.
2. Y-axis line only.
3. X- and Y-axis lines with the X-axis line evaluated *first*.
4. X- and Y-axis lines with the Y-axis line evaluated *first*.
5. Two X-axis lines and one Y-axis line with the X-axis lines evaluated *first*.
6. Two Y-axis lines and one X-axis line with the Y-axis lines evaluated *first*.

The "X" and "Y" refer to the physical orientation of the reference line(s) on the monitor screen: horizontal (X-axis), vertical (Y-axis), or both.

Your choice of "type" depends on the expected workpiece *shift and/or rotation* in your CVIM application.

Selecting Define Ref.Line Popup Menus and Parameters (continued)

Selecting Ref.Line Type *Popup Menu* (continued)

The questions you need to answer about workpiece position during an inspection is this: Do you expect the workpieces to be *shift* from the "original" position? If so, will they shift up or down (Y axis), left or right (X axis), or in both directions? Will they rotate?

A general guide for choosing the appropriate reference line type is as follows:

- X Only provides a horizontal reference line. Select the X Only reference line type if a workpiece is likely to shift horizontally, but not vertically.
- Y Only provides a vertical reference line. Select the Y Only reference line type if a workpiece is likely to shift vertically, but not horizontally.
- X Then Y provides both a horizontal and a vertical reference line. The CVIM system checks the X-axis line first and *applies shift compensation to the Y-axis line*:

Reference Line Type: X Then Y:

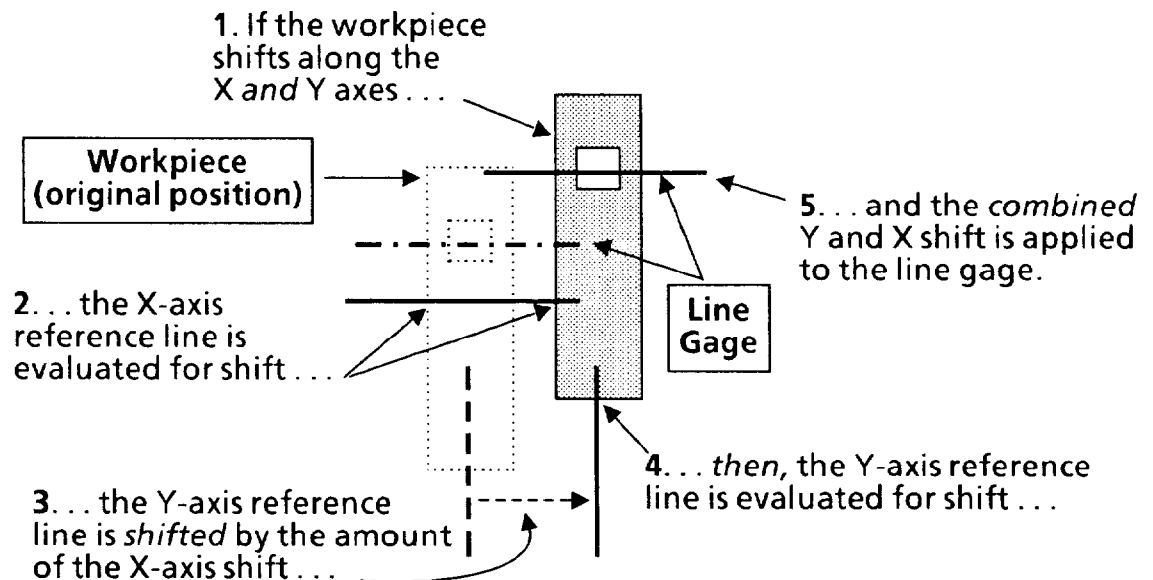

Select the X Then Y reference line type if the workpiece is likely to shift both horizontally and vertically, but is expected to shift *more* along the X axis.

**Selecting Define Ref.Line
Popup Menus and
Parameters (continued)**

Selecting Ref.Line Type *Popup Menu* (continued)

● Y Then X provides both a horizontal and a vertical reference line. The CVIM system checks the Y-axis line first and applies shift compensation to the X-axis line:

Reference Line Type: Y Then X:

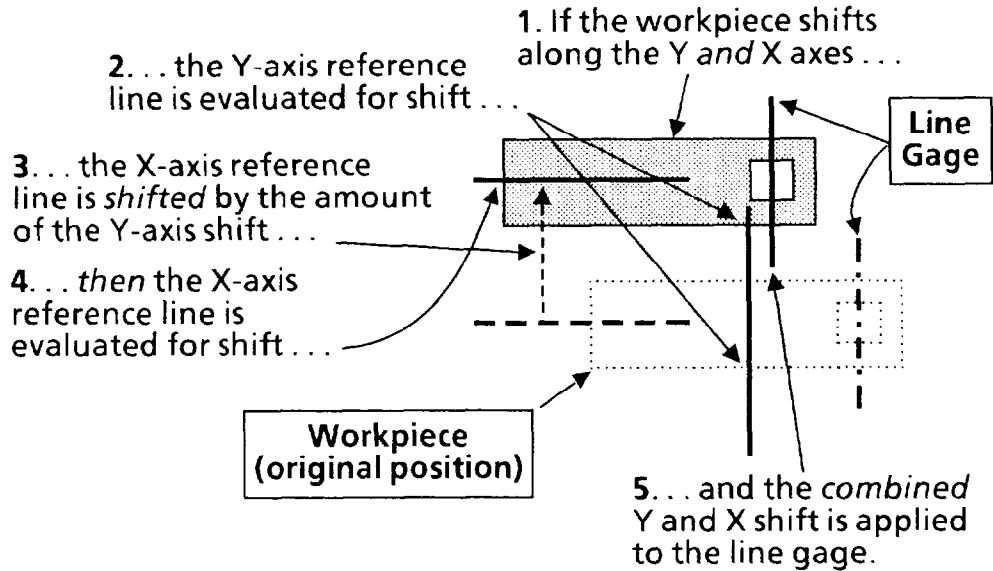

Select the Y Then X reference line type if the workpiece is likely to shift both horizontally and vertically, but is expected to shift *more* along the Y axis.

● X-X Then Y provides two horizontal lines and one vertical line. In this case, the CVIM system checks the two X-axis lines first and applies shift compensation to the Y-axis line.

Reference Line Type: X-X Then Y:

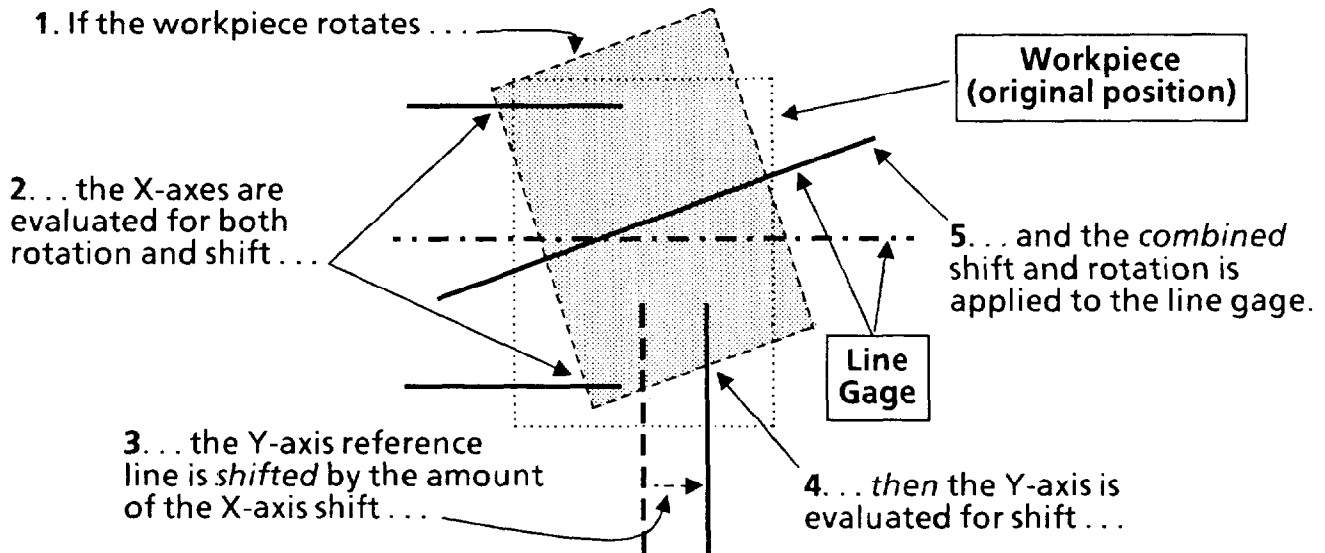

Selecting Define Ref.Line Popup Menus and Parameters (continued)

Selecting Ref.Line Type *Popup Menu* (continued)

The X-X Then Y reference line type also uses the difference in the *amount* of shift along the two X axes to calculate the number of degrees that an inspected workpiece has rotated from the position of the "original" workpiece.

- Y-Y Then X provides one horizontal line and two vertical lines. The CVIM system checks the two Y-axis lines first and applies shift compensation to the X-axis line.

Reference Line Type: Y-Y Then X:

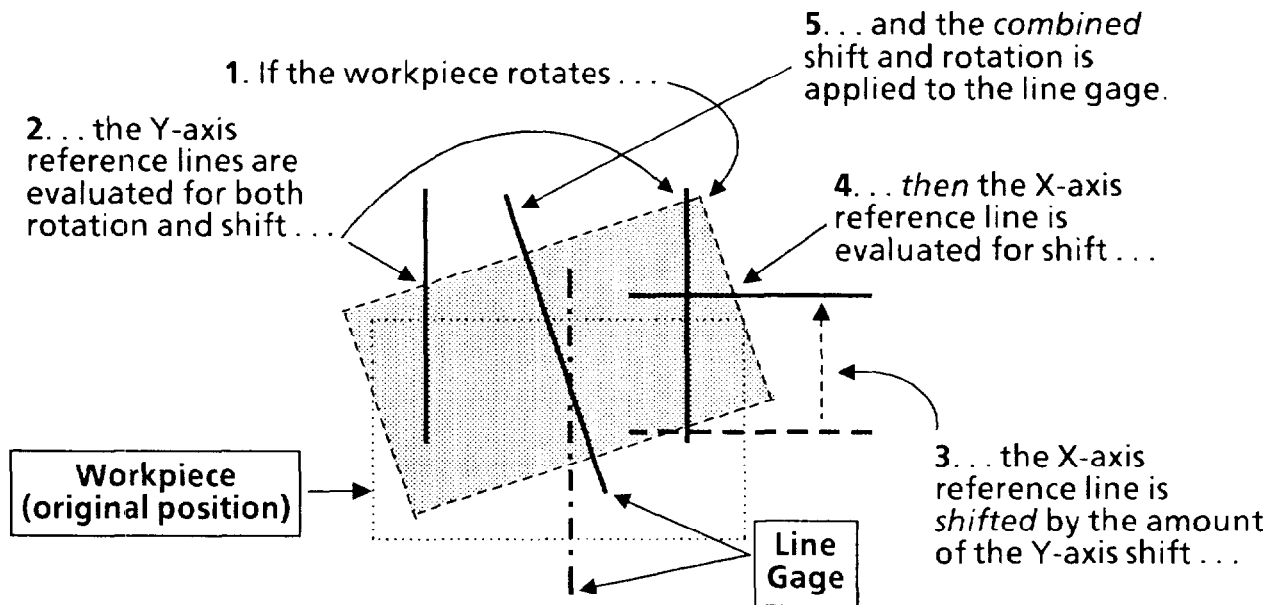

The Y-Y Then X reference line type also uses the difference in the *amount* of shift along the two Y axes to calculate the number of degrees that an inspected workpiece has rotated from the position of the "original" workpiece.

Your Action

Look at the Type menu box in the Define Ref.Line popup menu.

Comments

The Type menu box indicates the currently selected reference line type. If it is *not* the type you want, continue with the next steps.

**Selecting Define Ref.Line
Popup Menus and
Parameters (continued)**

Selecting Ref.Line Type Popup Menu (continued)

Your Action

Pick the Type menu box.

Comments

When you pick the Type menu box, the Ref.Line Type popup menu should appear, as follows:

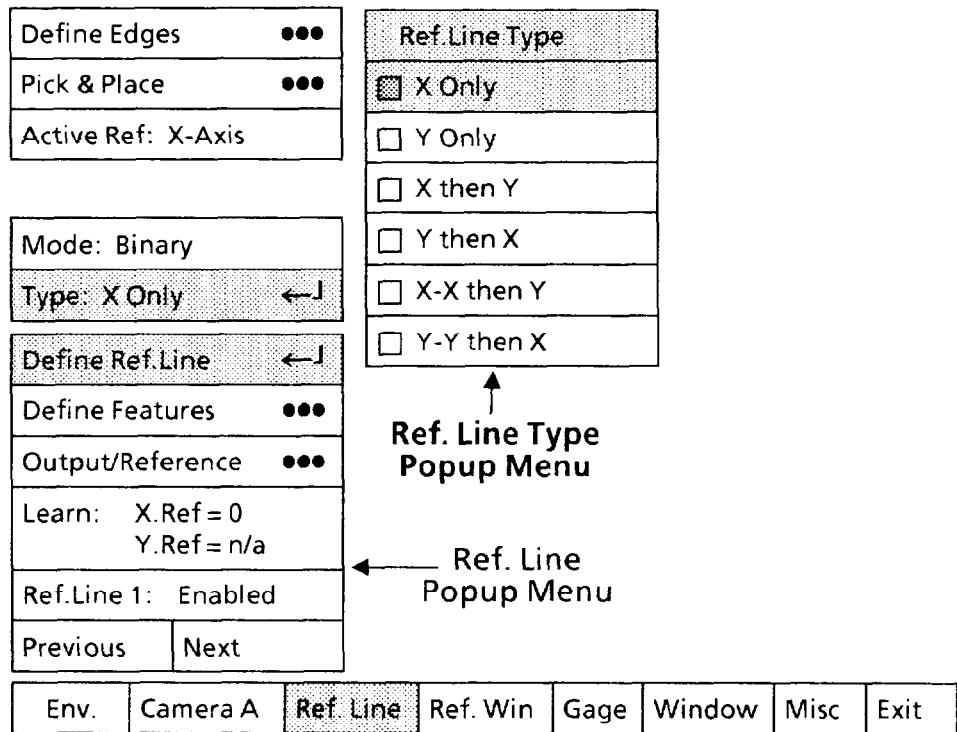

Note that the X Only box in the Ref.Line Type popup menu has a shaded square (☐). This indicates that X Only is the currently selected reference line type.

Pick the appropriate "type" box in the Ref.Line Type popup menu.

When you pick the box, the new selection will be highlighted in the Ref.Line Type popup menu and will appear in the Type menu box. In addition, the new reference line symbol will appear on the screen.

Selecting Active Reference Line

If you selected X Only or Y Only as the reference line type, skip this function. If, however, you selected one of the other types, continue with the next steps, and select the axis that you want to configure at this time.

Your Action

Look at the Active Ref menu box in the Define Features popup menu.

Comments

The Active Ref menu box indicates which axis is currently "active" for configuration purposes.

**Selecting Define Ref.Line
Popup Menus and
Parameters (continued)**

Your Action

*Pick the Active Ref menu
box, if appropriate.*

Selecting Active Reference Line (continued)

Comments

When you pick the Active Ref box, it will either toggle between X-Axis and Y-Axis or change from X-Axis to Y-Axis to X/Y-Axis, according to the *type* that you selected.

Select the axis that you want to configure at this time.

Selecting Binary or Gray Scale Mode

Select the appropriate mode for each reference line.

NOTE: The mode that you select will apply to X-axis *and* Y-axis reference lines.

The Binary mode changes pixels in the screen image to two states, white and black. The only pixels changed are those that directly surround the reference line in a box called the "area of interest." The CVIM system examines only these pixels when processing a reference line

The binary mode is most appropriate when the workpiece has a sharp black-and-white contrast with its background, such as when it is backlighted.

The Gray Scale mode does not affect the pixels surrounding the reference line – they remain in their original state, in which they can have any one of 64 shades of gray.

The gray scale mode is most appropriate when the workpiece has less contrast with its background, such as when it is frontlighted. In this case, features on the workpiece may appear in the screen image as varying shades of gray, and the binary mode may not enable you to identify a *stable* edge location on these features.

Use the following steps to select the Binary or Gray Scale mode.

Your Action

*Look at the Mode menu box
in the Define Ref.Line
popup menu.*

*Pick the Mode menu box,
if appropriate.*

Comments

The Mode menu box indicates the currently selected mode: Binary, or Gray Scale.

When you pick the Mode menu box, the mode will toggle to the *other* mode. Thus, Binary will change to Gray Scale, or vice versa.

**Selecting Define Ref.Line
Popup Menus and
Parameters (continued)**

Using Pick & Place Function

Pick the Pick & Place menu box, then position the reference line over the workpiece and set the line's length.

The following procedure shows you how to use the light pen to adjust the position and length of a reference line. The procedure refers *specifically* to an X-axis line, as shown below, but you can also apply it to a Y-axis line.



Your Action

Pick the Pick & Place menu box in the Define Ref.Line popup menu.

Comments

When you pick the Pick & Place menu box, a small square (□) will appear in the center, and at each end, of the currently selected reference line, as follows:

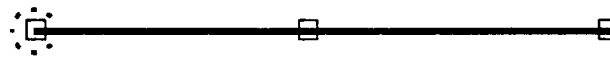

Aim the light pen at the center handle.

These squares are the "handles" that the light pen uses to manipulate the reference line on the screen.

Aim the light pen at the center handle until the light pen "sees" the handle. You may have to move the light pen around slightly.

When the light pen sees the handle, a larger "highlight" square will surround the handle, as follows:



Hold the pen steady in this position – the appearance of the "highlight" square means that the light pen is now properly aimed.

Pick the handle.

You can now "drag" the reference line around on the screen. When you move the pen, the line follows.

**Selecting Define Ref.Line
Popup Menus and
Parameters (continued)**

Using Pick & Place Function (continued)

Your Action

Comments

Drag the reference line to the position shown.

Note that the *right* end of the reference line is at the *rightmost shift limit*. This is the point *beyond* which one or more inspection tools used in your application cannot accurately inspect a workpiece – for example, the tool may be shifted out of the screen image.

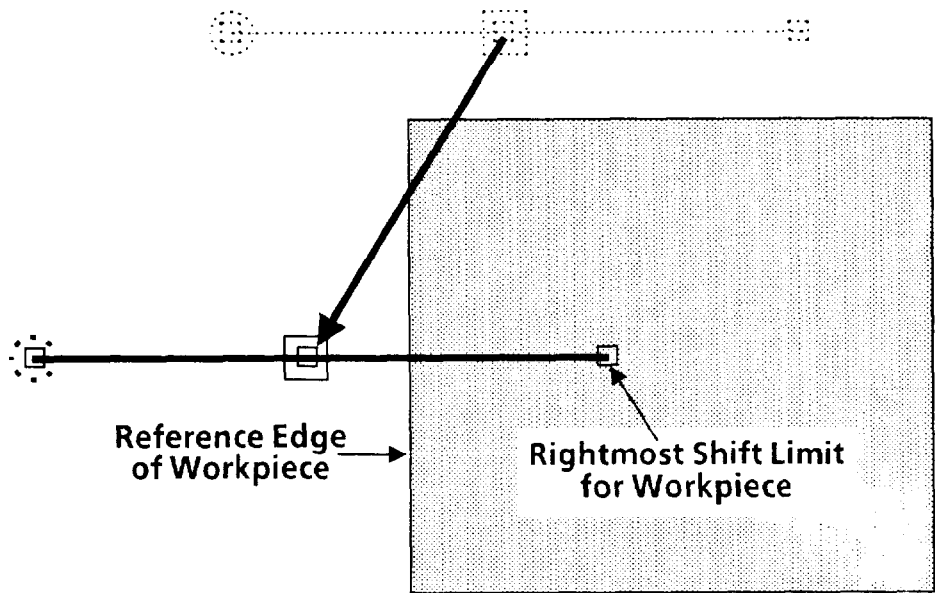

Note: Keep the tip of the pen within about one-half inch of the screen.

When you have the reference line in position over the workpiece, press the pen against the screen to “lock” the line at that position.

Aim the light pen at the leftmost handle.

Continue when the highlight square appears.

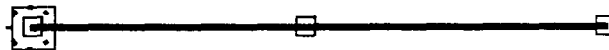

**Selecting Define Ref.Line
Popup Menus and
Parameters (continued)**

Using Pick & Place Function (continued)

Your Action

Pick the handle.

*Drag the left end of the
reference line so that it is
at the leftmost shift limit.*

Comments

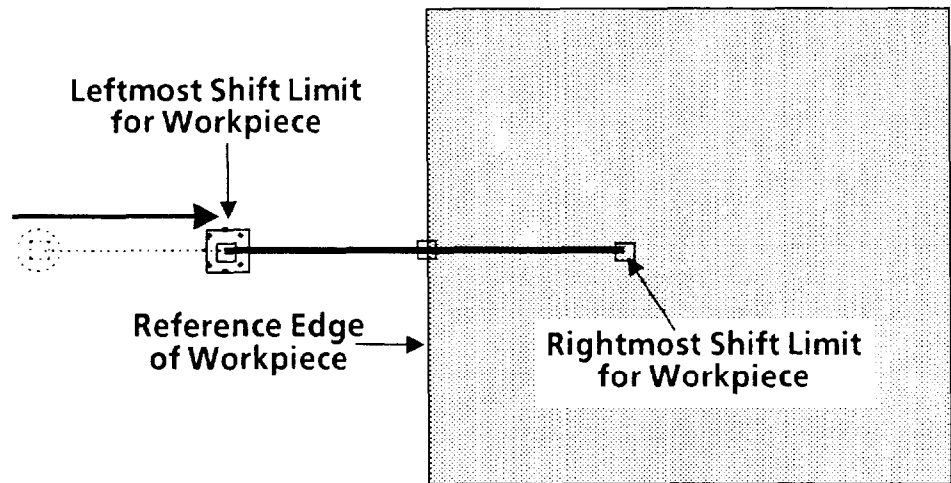

*Lock the left end in the
position shown.*

*If necessary, use the vernier
arrows to "fine-tune" the
position of the line or
line end.*

You can position the line or line end more *precisely* by using the *vernier* arrows. These arrows enable you to move the line or line end in increments of one pixel.

You can access the vernier arrows while either *picking* a line handle or *placing* a line or line end.

Selecting Define Ref.Line Popup Menus and Parameters (continued)

Using Pick & Place Function (continued)

Your Action

Press and hold the light pen tip against the line handle, line, or line end.

Comments

Hold the light pen tip in for about *one second*. The vernier arrows will then appear in the lower-right corner of the screen:

VERNIER ARROWS

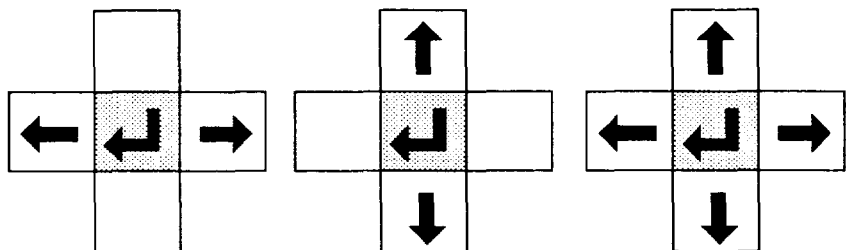

Move line end
left or right
(X-axis line)

Move line end
up or down
(Y-axis line)

Move line up,
down, left, or
right

Pick an arrow once to move the line or line end one pixel in the arrow's direction.

Pick and hold an arrow to move the line or line end continuously.

Pick the "return" symbol to release the vernier arrows.

Pick the up, down, right, or left arrow, as appropriate, to move the line or line end one pixel in the direction indicated by the arrow.

When you pick and hold an arrow, the line or line end will move slowly for the first five or six pixels. It will then accelerate to a more rapid rate of movement.

When the line or line end is properly positioned, pick the "return" symbol (←↵) to release the vernier arrows and return to the pick-and-place mode.

The reference line should now be positioned over the workpiece so that during inspection operations it can detect the reference edge of a shifted workpiece lying within its length.

In this case, the CVIM system will supply shift compensation to any associated inspection tools.

If any workpiece shifts *outside* the leftmost or rightmost limits of the reference line, the CVIM system will indicate a reference tool *fault* and will *not* supply shift compensation to any associated inspection tools. Those tools will *not* perform their inspections. They will indicate a *fault* condition.

**Selecting Define Ref.Line
Popup Menus and
Parameters (continued)**

Using Define Edges Function: Binary Mode

Pick the Define Edges menu box, then perform the threshold adjustments in order to determine the reference edge that the reference line will be using to locate the workpiece.

If you have selected the Gray Scale mode, skip the next steps and go directly to the section called *Using Define Edges Function: Gray Scale Mode.*

Use the following steps for setting the threshold if you selected the Binary mode.

Your Action

Comments

Pick the Define Edges menu box in the Define Ref.Line popup menu.

If you have selected the Binary gaging mode, when you pick the Define Edges menu box, the Filter popup menu and slide bar appear on the monitor screen, as follows:

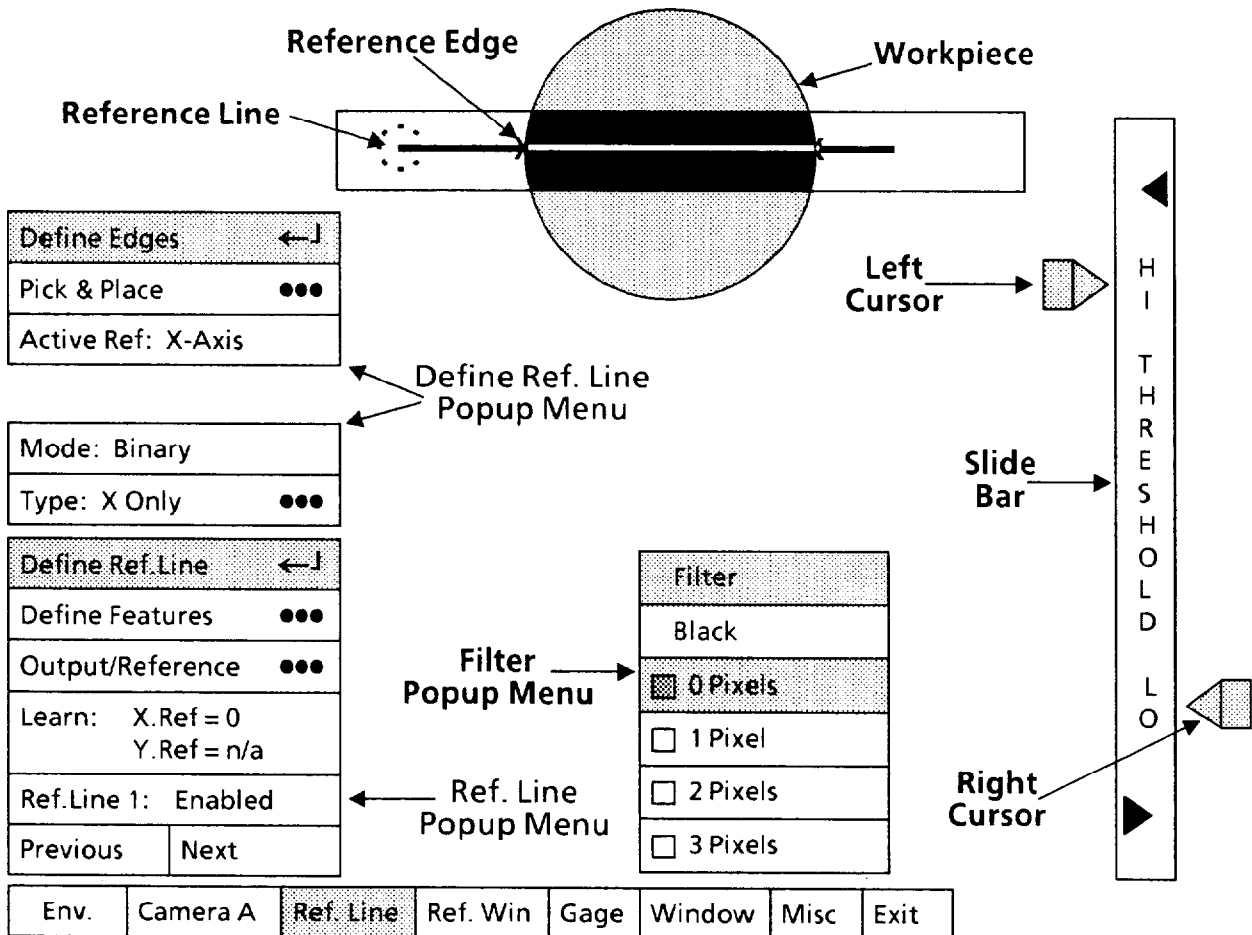

Also on the monitor screen, a small "X" may appear along the reference line wherever it "sees" an edge. As shown above, the reference line sees *two* edges on the circular workpiece.

If no X's appear, or if too many X's appear, you will need to adjust the threshold cursors and possibly set some value of white or black pixel filtering.

Selecting Define Ref.Line
Popup Menus and
Parameters (continued)

Using Define Edges Function: Binary Mode (continued)

Your Action

Comments

Look at the threshold cursors
on each side of the slide bar.

The cursors on each side of the slide bar are the principal means by which you will define "edges" (that is, transitions) that occur along the reference line. The reference line lies entirely within a box called the "area of interest." This box contains the binarized image. All parts of the image *outside* the box remain in gray scale form.

The cursors' positions along the slide bar represent *image brightness values* from 1 to 63, with 63 at the top and 1 at the bottom.

Think of the *left* cursor this way: Any part of the binary image area having a *higher* brightness value (that is, *lighter*) than the value indicated by the cursor's current setting will appear *black* in the binary image. For example, if the cursor is set to a brightness value of 45, then all parts of the binary image having brightness values *higher than 45* will appear *black*.

Think of the *right* cursor this way: Any part of the binary image area having a *lower* brightness value (that is, *darker*) than the value indicated by the cursor's current setting will appear *black* in the binary image. For example, if the cursor is set to a brightness value of 27, then all parts of the binary image having brightness values *lower than 27* will appear *black*.

Thus, all parts of the binary image having a brightness value *between* the current settings of the two cursors will appear *white*. In the examples above, all parts of the binary image having brightness values from 27 to 45 will appear *white*; all other parts will appear *black*.

Pick left cursor.

Aim the light pen at the cursor. When you see a red box around the cursor, pick the cursor. This causes the cursor to turn yellow, indicating that you can now "drag" the cursor up or down.

Drag the left cursor to its
topmost position.

This initializes the left cursor to the "63" brightness value.

Pick and drag the right cursor
to its bottommost position.

This initializes the right cursor to the "1" brightness value.

Pick the left cursor again
and drag it downward.

Drag the cursor *downward* until those parts of the binary image that you want to be *white* start to turn black. Then, drag the cursor up slightly until those same areas just change to *white* again.

As you drag the cursor up and down, an X will appear along the reference line wherever an edge (binary transition) is detected.

Selecting Define Ref.Line Popup Menus and Parameters (continued)	Using Define Edges Function: Binary Mode (continued)
Your Action	Comments
<i>Pick the right cursor <u>again</u> and drag it <u>upward</u>.</i>	<p>Drag the cursor <i>upward</i> until those parts of the binary image that you want to be <i>black</i> just turn <i>black</i>.</p> <p>As you drag the cursor up and down, an X will appear along the reference line wherever an edge (binary transition) is detected.</p>
<i>Alternately pick and drag each cursor until a stable X appears at the reference edge.</i>	<p>Your objective is to produce a stable X at the <i>reference</i> edge, which is the edge that the reference line must “see” in your application. Other X’s may <i>also</i> appear along the reference line; however, you can configure the system to recognize only the X at the reference edge.</p> <p>Try various positions of the two cursors to produce the most <i>stable</i> X at the desired edge reference.</p> <p>Trial and observation is the correct procedure for setting the binary threshold.</p>
<i>Look at the Filter menu.</i>	<p>If white or black “noise” in the image <i>prevents</i> you from getting a single, stable X at the desired reference edge, try using white or black filtering.</p> <p>In the Filter menu, the filled-in square (◻) shows the currently selected filter level. This determines the number of consecutive black or white “noise” pixels that will be removed (filtered) before the reference line looks for the reference edge. Black or White determines which <i>color</i> of pixel should be considered “noise.”</p> <p>The filter, in effect, masks out the “noise” pixels so that they don’t create false edges.</p> <p>For example, if the filter menu is set to White and 3 Pixels, and the reference line encounters three (or fewer) consecutive white pixels in a stream of black pixels, these white pixels are removed (filtered out), and no edge is detected.</p> <p>If, on the other hand, the reference line encounters four (or more) consecutive white pixels, an edge <i>is</i> detected (actually, <i>two</i> edges will be detected – a leading edge and a trailing edge – if the reference line crosses <i>through</i> the string of white pixels).</p>
<i>Pick the White or Black menu box in the Filter popup menu.</i>	<p>Your objective is to set the filter to a level that removes enough visual “noise” from the binary image to prevent the reference line from detecting false edges.</p> <p>This menu box “toggles” between White and Black when you pick it repeatedly. Select White to filter out small white noise, or select Black to filter out small black noise.</p>

**Selecting Define Ref.Line
Popup Menus and
Parameters (continued)**

Using Define Edges Function: Binary Mode (continued)

Your Action

Pick the appropriate filter value from the Filter menu.

Comments

If your application does *not* need filtering, pick 0 Pixels. Otherwise, try various values of filtering to get the cleanest binary image *and* a single, stable X at the reference edge.

As is the case in setting the binary threshold, trial and observation is appropriate here. You may want to try several filter settings to see which one is best for your particular application.

Using Define Edges Function: Gray Scale Mode

Use the following steps for setting the threshold/scale if you selected the Gray Scale mode.

Pick the Define Edges menu box in the Define Ref.Line popup menu.

If you have selected the Gray Scale mode, when you pick the Define Edges menu box, the slide bar appears on the monitor screen, as follows:

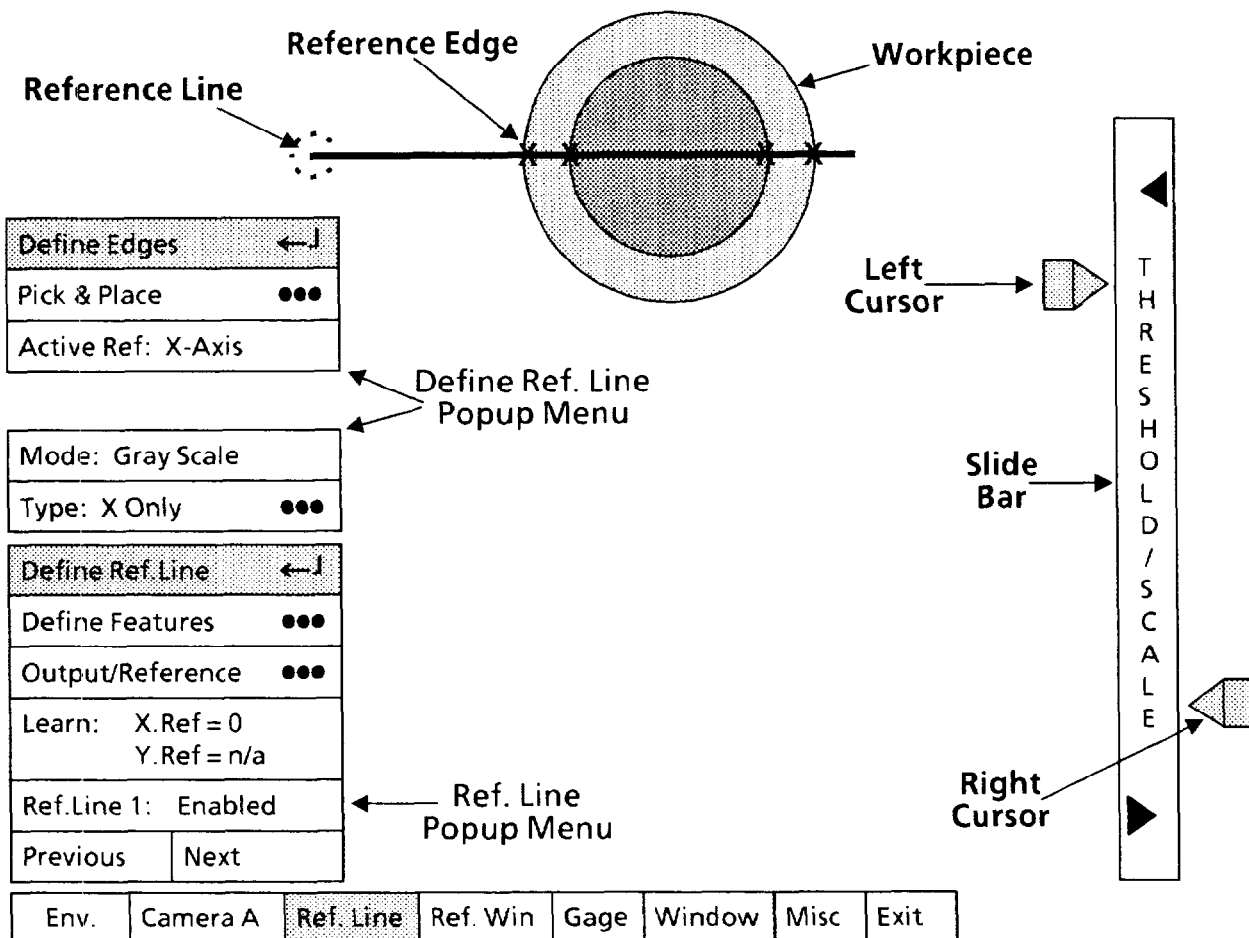

**Selecting Define Ref.Line
Popup Menus and
Parameters (continued)**

Using Define Edges Function: Gray Scale Mode (continued)

Your Action

Comments

<i>Look at the cursors on each side of the slide bar.</i>	<p>Also on the monitor screen, a small "X" will appear along the reference line wherever it "sees" an edge. As shown above, the reference line sees <i>four</i> edges on the circular workpiece.</p> <p>If no X's appear, or if too many X's appear, you will need to adjust the threshold/scale cursors.</p>
<i>Pick the <u>left</u> cursor.</i>	<p>The cursors on each side of the slide bar are the principal means by which you will define the gray scale image in which the "edges" (that is, the transitions) occur along the reference line.</p> <p>The <i>left</i> cursor represents the current setting of the "gradient threshold." This setting determines the <i>minimum</i> change in brightness value that must occur, <i>within the number of pixels indicated by the scale factor</i>, before the CVIM system can "detect" an edge.</p> <p>When the left cursor is at its <i>lowest</i> position, it selects a gradient threshold value of 0.00. This indicates that <i>any</i> change in brightness value will cause the system to detect an edge. When the cursor is at its <i>highest</i> position, it selects a gradient threshold value of 63.00. This indicates that the system will detect an edge <i>only</i> when the change in brightness value is 63.</p> <p>The <i>right</i> cursor represents the current setting of the "scale factor." This setting determines the <i>number of consecutive pixels</i> that the CVIM system examines to determine whether or not an edge (transition) exists. Note that the larger values of scale factor increase processing time.</p>
<i>Drag the left cursor to its bottommost position.</i>	<p>When the right cursor is at its <i>lowest</i> position, it selects the smallest scale factor (2); and when the cursor is at its <i>highest</i> position, it selects the largest scale factor (41).</p>
<i>Pick and drag the <u>right</u> cursor to its bottommost position.</i>	<p>Aim the light pen at the cursor. When you see a red box around the cursor, pick the cursor. This causes the cursor to turn yellow, indicating that you can now "drag" the cursor up and down.</p>
<i>Pick the right cursor <u>again</u> and drag it <u>upward</u>.</i>	<p>This initializes the left cursor to the "0.00" gradient threshold.</p> <p>This initializes the right cursor to the "2" scale factor. At this point, many X's ("edges") may appear along the reference line.</p> <p>Drag the cursor <i>upward</i> until the X's at the desired edges are in good, stable locations. Many edges may still be present along the reference line.</p>

**Selecting Define Ref.Line
Popup Menus and
Parameters (continued)**

Using Define Edges Function: Gray Scale Mode (continued)

Your Action

Comments

*Pick the left cursor again
and drag it upward.*

Drag the cursor *upward* until you remove as many of the unwanted X's as possible *without* losing the X at the reference edge of your workpiece.

*Alternately pick and drag
each cursor until a stable X
appears at the reference edge.*

Your objective is to produce a stable X at the *reference* edge, which is the edge that the reference line must "see" in your application. Other X's *may persist* along the reference line – you may not be able to get rid of all extraneous X's. You can, however, configure the system to recognize only the X at the reference edge.

Try various positions of the two cursors to produce the most *stable* X at the desired edge reference.

Trial and observation is the correct procedure for setting the gray scale threshold.

**Selecting Define Features
Popup Menu and Parameters**

Select the Define Features popup menu, then select the parameters in that menu. Basically, these parameters specify the edge (or midpoint) that the X and/or Y axis of the reference line will search for and the direction of search.

Your Action

Comments

*Pick the Define Features
menu box in the Ref. Line
popup menu.*

When you pick the Define Features menu box, the Define Features popup menu appears above the Ref. Line popup menu, as follows:

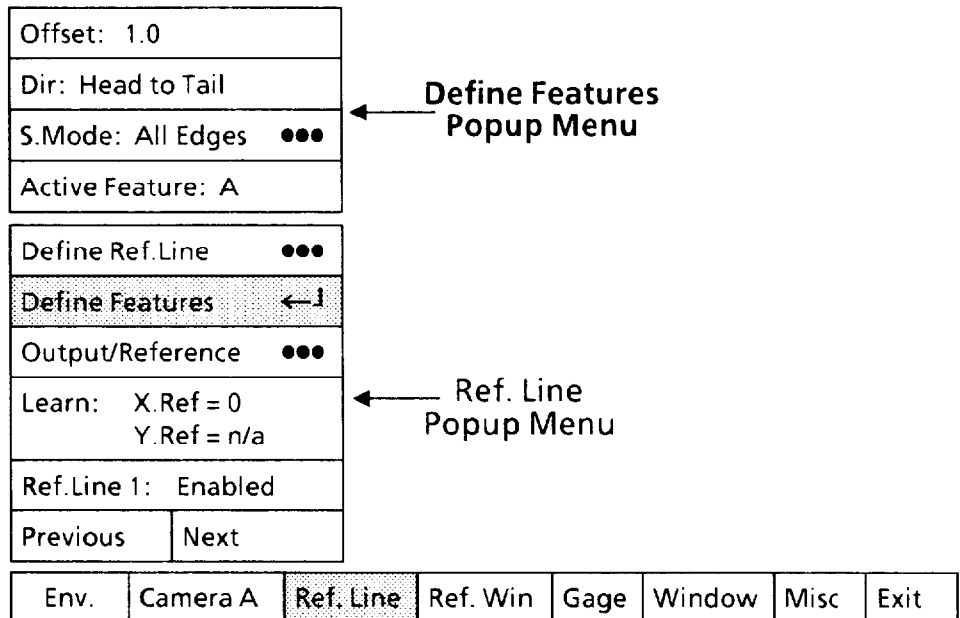

**Selecting Define Features
Popup Menus and
Parameters (continued)**

Notice also the letter **A**, **B**, or **C** on the reference line(s). **A** will appear somewhere on the X-axis line, **B** will appear somewhere on the Y-axis line, and **C** will appear somewhere on the "X-X" or "Y-Y" axis.

NOTE: Reference lines have only *one* feature.

The letters **A**, **B**, and **C** indicate the *current* location of the reference edge on the corresponding axis. The following steps provide the means for selecting the reference edge location(s) on each axis that are appropriate for your application.

Selecting Active Feature

If you selected X Only or Y Only as the reference line *type*, *skip* this function. If, however, you selected X Then Y, Y Then X, X-X Then Y, or Y-Y Then X, continue with the next steps and select the axis that is to be configured at this time.

Your Action

Look at the Active Feature menu box in the Define Features popup menu.

Pick the Active Feature menu box, if appropriate.

Comments

The Active Feature menu box indicates the "feature" (that is, **A**, **B**, or **C**) that is currently "active" for configuration purposes. Thus, **A** means the X-axis line is active, **B** means the Y-axis line is active, and **C** means the X-X or Y-Y axis is active.

When you pick the Active Feature box, the "active feature" will change to the next letter. Thus, **A** will change to **B**, and **B** will change to **C** (or **A**).

Pick **A** to select the reference edge on the X axis, or **B** to select the reference edge on the Y axis, or **C** to select the reference edge on the X-X or Y-Y axis.

Selecting Search Direction

Select the *direction* in which the specified axis will search for the specified reference edge or midpoint.

Your Action

Look at the Dir menu box in the Define Features popup menu.

Comments

The Dir menu box shows the currently selected direction that the reference line will use to search for edges. The direction can be either Head to Tail or Tail to Head.

Selecting Define Features Popup Menus and Parameters (continued)

Your Action

Pick the Dir menu box,
if appropriate.

Selecting Search Direction (continued)

Comments

When you pick the Dir menu box, the search direction toggles to the opposite direction. Thus, Head to Tail will change to Tail to Head, or vice versa.

NOTE: The *best* search direction is the one in which the reference line is the least likely to encounter a *false* reference edge, as follows:

If this is the reference edge . . .

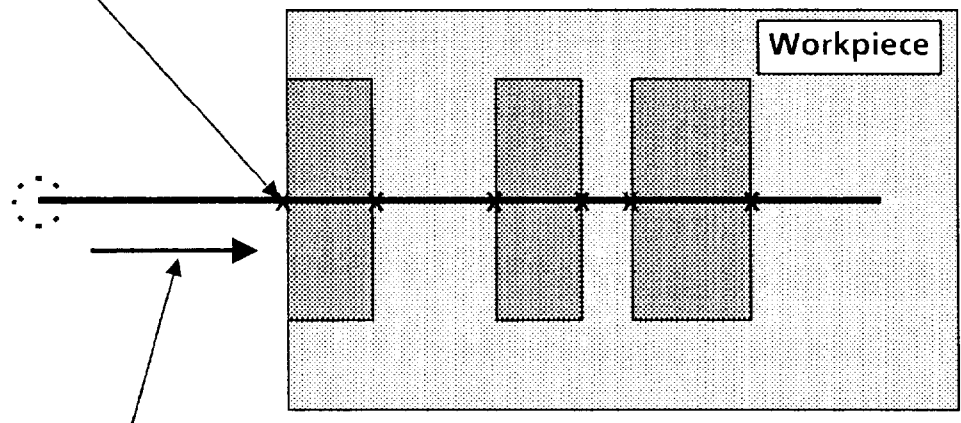

. . . the search direction should be Head-to-Tail

Select the appropriate search direction for the reference line.

Selecting S. Mode Popup Menu

Select the S. Mode popup menu, then select one of four modes by which the reference line will search for an edge:

1. Search for *all* edges along the length of the reference line.
2. Search *only* for the edges of the largest *white* object along the reference line. (This is not available with the gray scale gaging mode.)
3. Search *only* for the edges of the largest *black* object along the reference line. (This is not available with the gray scale gaging mode.)
4. Search *only* for the edges of the largest *object* along the reference line.

Your Action

Look at the S. Mode
menu box in the Define
Features popup menu.

Comments

The S. Mode menu box shows the currently selected mode for searching for edges along the reference line.

Selecting Define Features Popup Menus and Parameters (continued)

Selecting S. Mode Popup Menu (continued)

Your Action

Pick the S. Mode menu box.

Comments

When you pick the S. Mode menu box, the Search Mode popup menu appears on the right side of the screen, as follows:

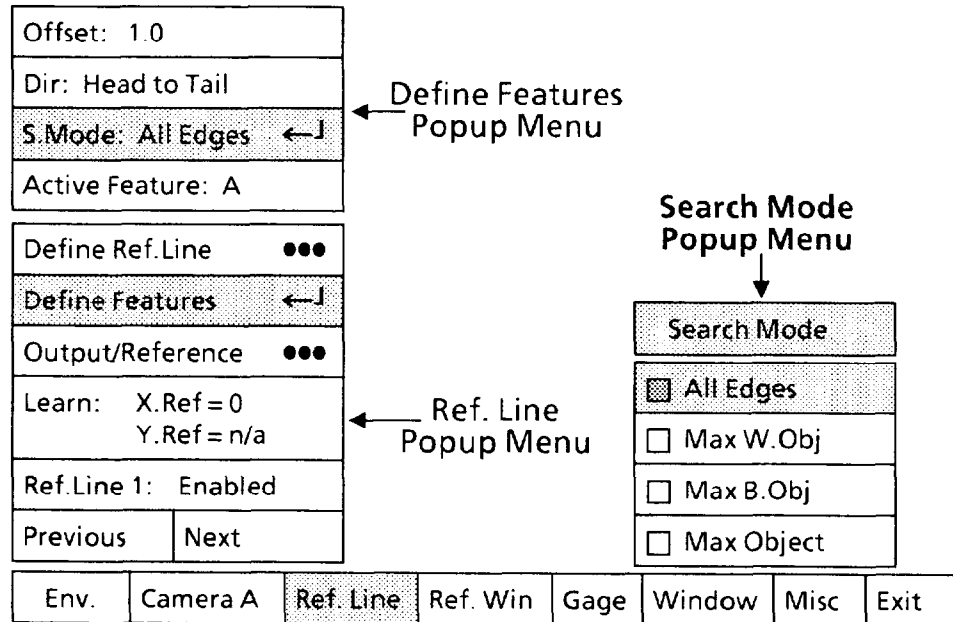

Note that the All Edges box in the Search Mode popup menu has a shaded square (). This indicates that All Edges is the currently selected edge search mode.

These are the four edge-search modes in the Search Mode popup menu:

- 1. All Edges:** This search mode causes the reference line to search for all edges, all midpoints between edges, and the *starting* end of the reference line.
- 2. and 3. Max W. Object: or Max B. Object:** These search modes cause the reference line to search for one edge and the midpoint of the largest white (or black) object along a reference line. These modes are valid only with the *binary* mode.
- 4. Max Object:** This search mode causes the reference line to search for one edge and the midpoint of the largest object between two *consecutive* edges along the reference line.

Selecting Define Features Popup Menus and Parameters (continued)

Selecting S. Mode *Popup Menu* (continued)

The examples in the following figures show the effects of different combinations of search mode, binary or gray scale mode, and search direction.

In Example #1, the active feature searches the *head* ("fixed"), the *point* between the first and last edge ("center"), and all *edges* and *midpoints* between adjacent edges.

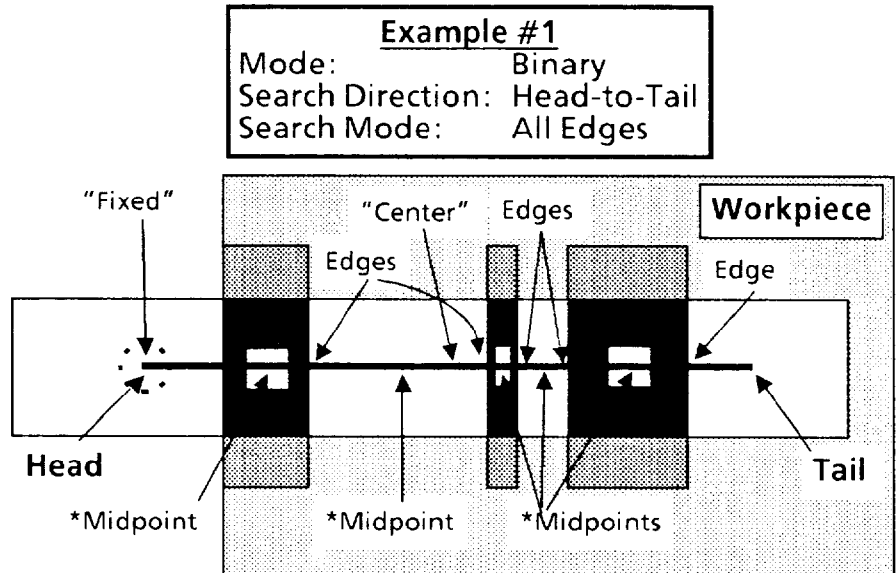

*The small white squares in this figure enable showing the midpoint locations of the black objects. They are not "holes" in the workpiece.

In Example #2, as in example #1, the active feature searches for the *tail* ("fixed"), the *point* between the first and last edge ("center"), and all *edges* and *midpoints* between adjacent edges.

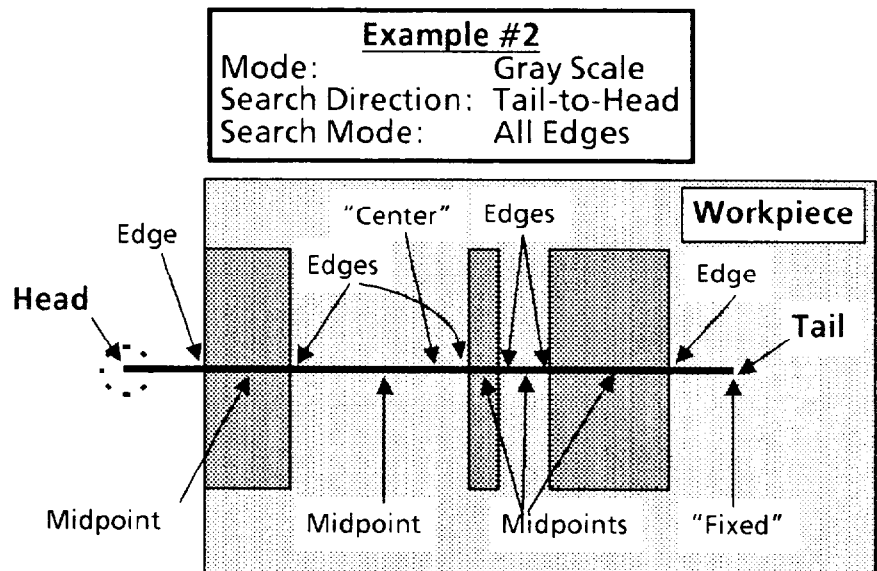

**Selecting Define Features
Popup Menus and
Parameters (continued)**

Selecting S. Mode Popup Menu (continued)

In Example #3, the active feature will search *only* for the edge at the *head* side of the largest black object and the midpoint between the two edges of that object.

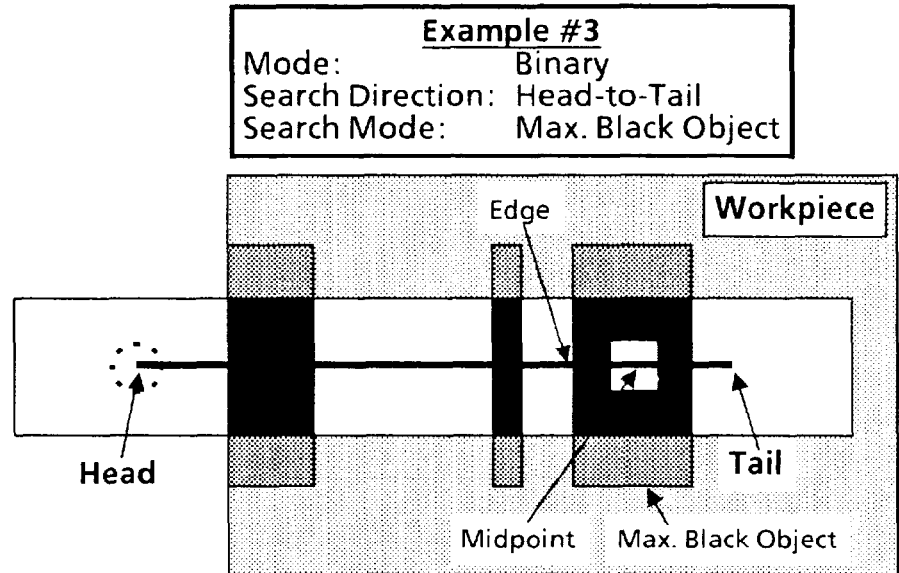

In Example #4, the active feature will search *only* for the edge at the *head* side of the largest white object and the midpoint between the two edges of that object.

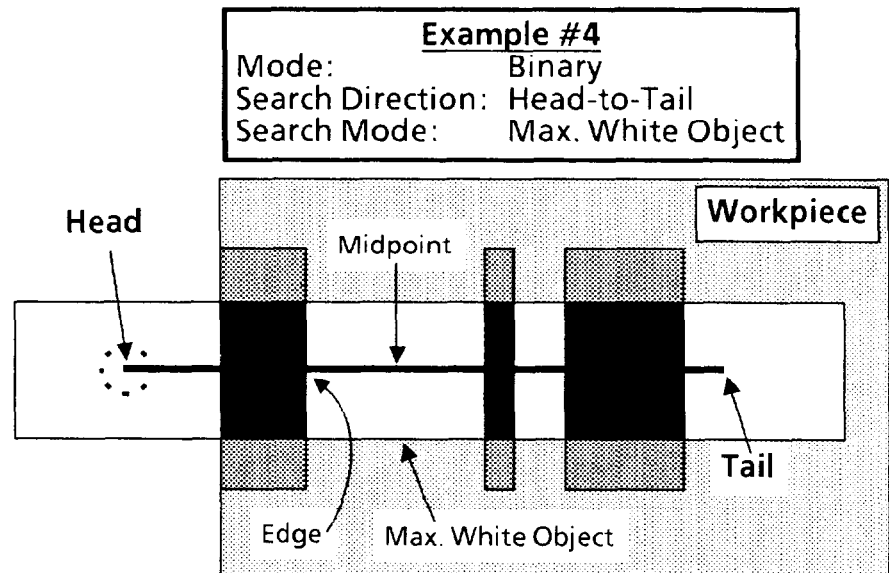

Selecting Define Features Popup Menus and Parameters (continued)

Selecting S. Mode Popup Menu (continued)

In Example #5, the active feature will search *only* for the edge at the *tail* side of the largest *object* (the largest *white* object in example #4) and the midpoint between the two edges of that object.

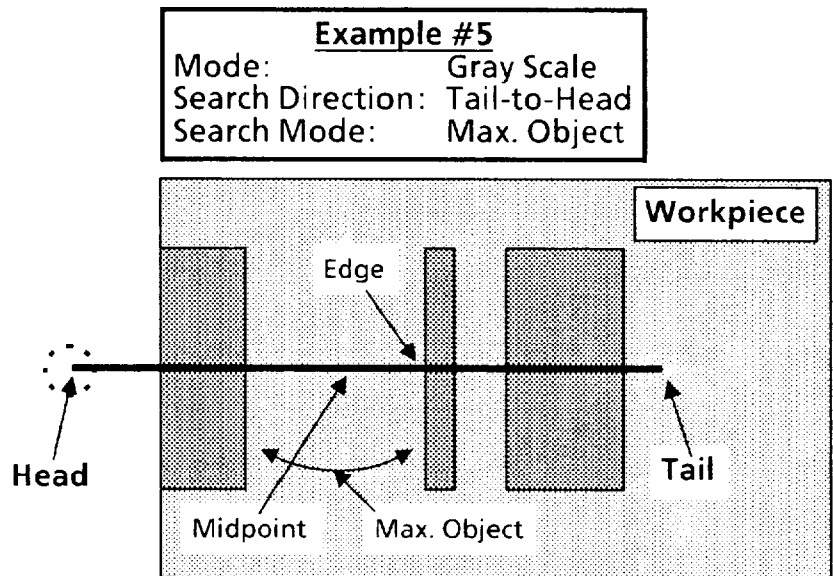

Your Action

Pick the edge-search mode that is appropriate for your application.

Comments

Using Offset Function

Use the Offset function to accurately identify and assign to each reference line a *specific* point ("fixed," "center," edge, or midpoint) as the *single* reference "edge" for that line.

Your Action

Look at the Offset menu box in the Define Features popup menu.

Comments

The Offset menu box shows the current location of the "active feature." The location is stated as either a number (0.0, 1.0, 1.5, and so on) or a name (Fixed or Center).

**Selecting Define Features
Popup Menus and
Parameters (continued)**

Using Offset Function (continued)

Your Action

Comments

An offset *name* refers to a specific point on the reference line ("Fixed") or a specific position between the outside edges of the workpiece ("Center").

"Fixed" refers to either the *head* or the *tail* of a reference line, according to the designated search direction. For the Head-to-Tail search direction, the fixed point is at the head; for Tail-to-Head, it is at the tail.

"Center" refers to the center point between the first edge and the last edge on the reference line.

An offset *number* identifies either a specific *edge* or specific *midpoint* between adjacent edges. The number varies according to the designated search mode. Offset numbers for edges are designated 0.0, 1.0, 2.0, and so on. Offset numbers for midpoints are designated 0.5, 1.5, 2.5, and so on.

For the All Edges search mode, the first offset number is always 1.0, and the last is x.0, where (x) is the total number of edges on the reference line.

For the other search modes, the first number is always 0.0, an edge, and the second number is always 0.5, a midpoint.

The example below shows Active Feature A located at offset 1.0, which is edge #1. Note that the *highest* offset number in the example is 6.0, which is the last edge.

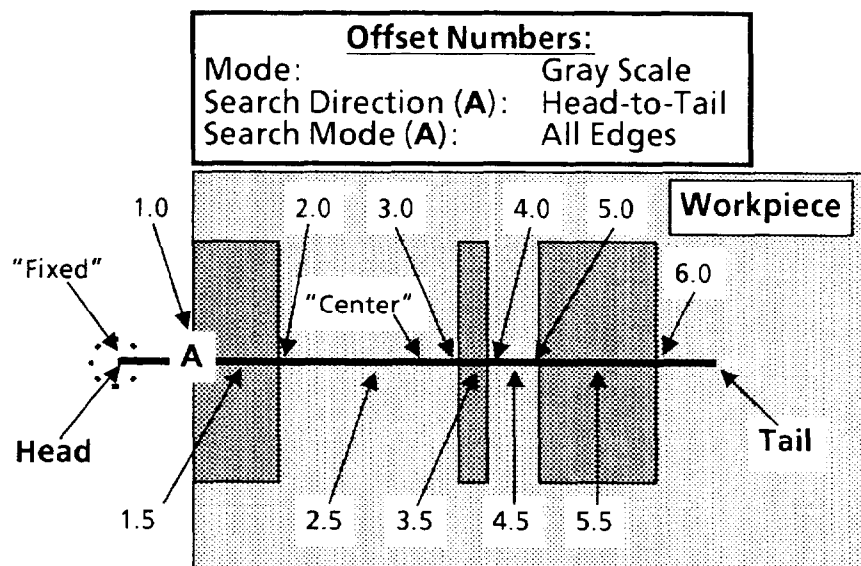

**Selecting Define Features
Popup Menus and
Parameters (continued)****Using Offset Function (continued)****Your Action**

*Pick the Offset menu box
as needed to position the
active feature.*

Comments

When you pick the Offset menu box, the offset position advances according to the designated search direction. In the example above, it starts with Fixed and continues with Center, 1.0, 1.5, 2.0, and so on.

The *positions* of letters **A** or **B** on the reference line correspond to their currently selected offsets. Thus, in the preceding figure, **A** corresponds to offset 1.0, which is edge #1.

When you pick Offset once more after **A** (or **B**) reaches the last edge or midpoint, **A** (or **B**) returns to the *starting* point, which varies according to the designated search mode and search direction.

For the All Edges search mode, the starting point is either the head or the tail of the reference line, according to the designated search direction, and the offset resets to "Fixed."

For the other search modes, the starting point is the edge of the "object," and the offset resets to 0.0.

Using Learn Function

Pick the Learn menu box in the Ref. Line popup menu to command the CVIM system to "learn" the coordinate(s) of the currently selected edge on the X axis and/or Y axis.

Your Action

Pick the Learn menu box.

Comments

When you pick the Learn menu box, the reference line "learns" the coordinates of the reference edge on the X and Y axes and displays them in the box. Note that if you selected X Only or Y Only as the reference line *type*, the inactive line will show n/a, or "not applicable."

The X and Y references are always stated in pixels from the *left* edge of the screen image for X, and from the *top* edge of the screen image for Y.

Thus, a reading of X.Ref = 114 indicates that the reference edge on the X-axis line is 114 pixels from the left edge of the screen image. A reading of Y.Ref = 25 indicates that the edge on the Y-axis line is 25 pixels from the top edge of the screen image. These pixel values reflect the image resolution parameter that you selected in Chapter 5, *Camera and Lighting Parameters*.

Look at the new X and Y coordinate values in the Learn menu box.

The new coordinate values indicate the current location of the reference edge along the X and Y axis.

Selecting Output/Reference Popup Menu and Parameters

Select the Output/Reference popup menu, then select the parameters in that menu.

Your Action

Pick the Output/Reference menu box in the Ref.Line popup menu.

Comments

When you pick the Output/Reference menu box, the Output/Reference popup menu appears above the Ref.Line popup menu, as follows:

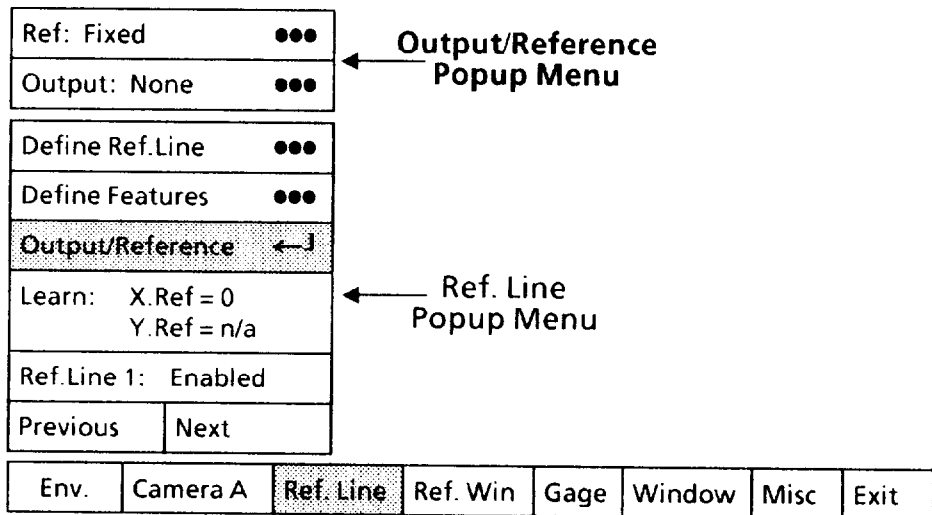

**Selecting Output/Reference
Popup Menu and Parameters**
(continued)

Selecting Output Line Selection Popup Menu

Select the Output Line Selection popup menu, if appropriate, then assign an output line to carry reference line "results" signals to your production equipment.

Your Action

Comments

Look at the Output menu box in the Output/Reference popup menu.

The Output menu box shows the currently selected output line number assigned to *this* reference line.

Pick the Output menu box in the Output/Reference popup menu.

When you pick the Output menu box, the Output Line Selection popup menu appears, as follows:

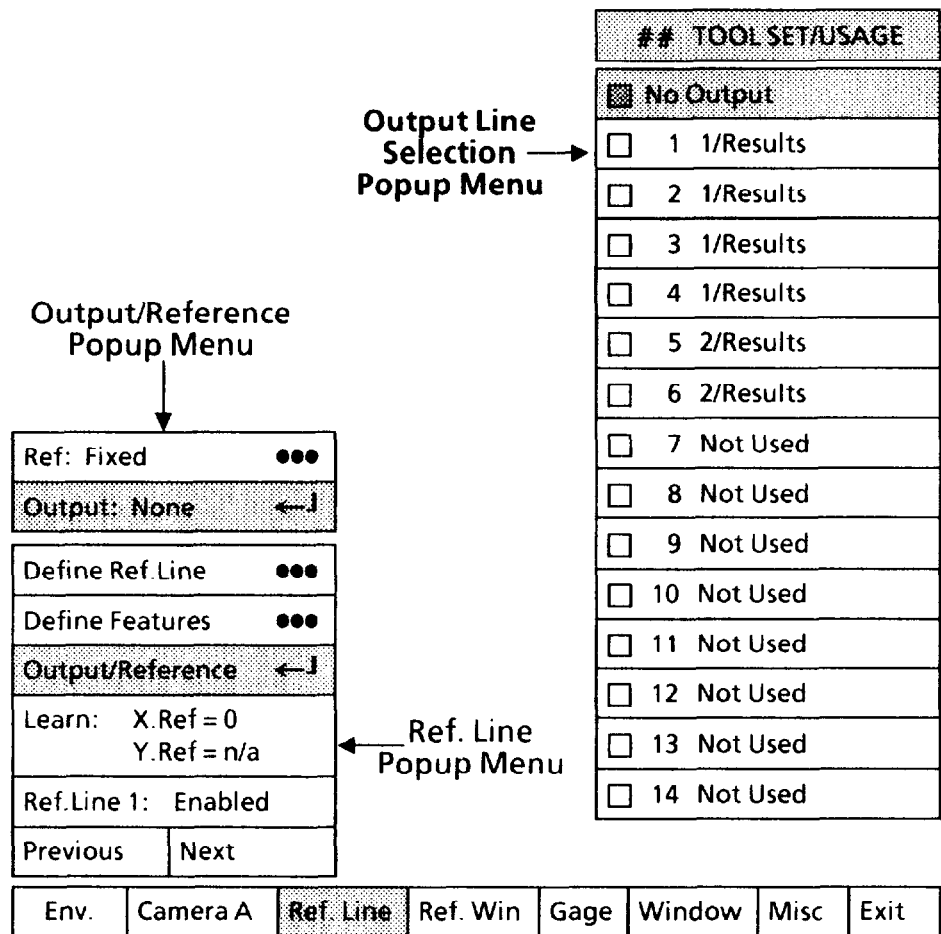

Note that the No Output box in the Output Line Selection menu has a shaded square (◻). This indicates that *no* output line is currently assigned to this reference line. Also note that you can pick *only* those output lines with a "Results" function shown in *light* type. All others are shown in **black** type, which indicates that you cannot pick them.

Pick the appropriate output line from the menu.

If appropriate, pick one of the available output lines from the Output Line Selection menu.

**Selecting Output/Reference
Popup Menu and Parameters**
(continued)

Selecting Reference Popup Menu

Select the Reference popup menu, if appropriate, then assign a reference tool to provide shift compensation to *this* reference line.

You can configure *one* reference line to receive shift compensation from *another* reference line (but *not* a reference window), with the following restrictions:

- Reference line #1 *cannot* receive shift compensation from *any* reference tool.
- Reference line #2 can receive shift compensation *only* from reference line #1.
- Reference line #3 can receive shift compensation from *either* reference line #1 or reference line #2.

Use the following steps to select a *reference* line for the currently selected reference line.

Your Action

Comments

Look at the Ref menu box in the Output/Reference popup menu.

The Ref menu box shows the currently selected reference line number assigned to *this* reference line.

Pick the Ref menu box in the Output/Reference popup menu.

When you pick the Ref menu box, the Reference popup menu appears, as follows:

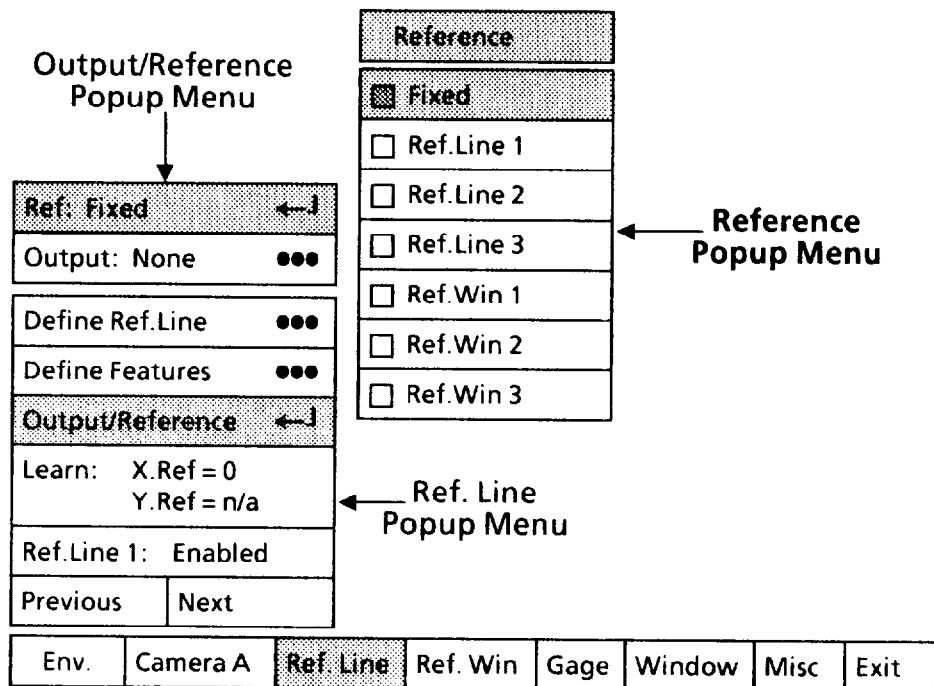

**Selecting Output/Reference
Popup Menu and Parameters
(continued)**

Selecting Reference *Popup Menu* (continued)

Your Action

Comments

Note that the Fixed box in the Reference menu has a shaded square (◻). This indicates that a reference tool is not currently assigned to *this* reference line. Also note that only the *available* reference tools are in *light* type. All others are shown in **black** type, which indicates that you cannot pick them.

*Pick the appropriate reference
line from the menu.*

If appropriate, pick one of the available reference lines from the Reference menu.

Reference Windows

This section provides you with the details of using and configuring reference windows.

Under the *Using Reference Windows* heading, you will see simple example applications in which the CVIM system uses reference windows to provide shift compensation and rotation for a linear gage. The system then uses that gage to measure the diameter of a hole in a metal plate.

Under the *Configuring Reference Windows* heading, you will find out how to use the “user interface” – the light pen and the popup menus on the CVIM video monitor – to configure a reference window.

Using Reference Windows

The following pages describe how the CVIM system can use reference windows to detect and measure workpiece shift and/or rotation, and offset inspection tools by the amount of that shift and/or rotation. As is true of reference lines, the advantage of using reference windows is that workpieces need *not* be rigidly fixtured for the CVIM system to inspect them.

NOTE: Before using reference windows, be sure that you have configured the image resolution, light reference threshold, and trigger source, and have adjusted the camera focus and aperture.

Each of the six numbered reference windows (three per tool set) consists of three “active features.” And each active feature consists of a *search* window and a *feature* window.

A *search* window defines the specific *area* of the image in which you want the CVIM system to search for *feature* that you specify.

A search window can be large enough to include almost all of the image area; however, as a practical matter, you are unlikely to need a search window of that size. As a rule, the search window should be only as large as it needs to be to cover the amount of workpiece shift and/or rotation that is acceptable for your application – since the larger the window size, the longer the processing time.

A *feature* window defines the specific *part* of the image that you want the CVIM system to search for within the search window.

The feature window size can be as small as 16-by-16 pixels, and as large as 64-by-64 pixels.

By using a single active feature, the CVIM system can compensate for workpiece shift along the horizontal and vertical axes. By using two or three active features, the system can compensate for workpiece shift and for rotation of up to $\pm 15^\circ$.

Using Reference Windows
(continued)**Shift-only Example**

The following example uses a *single* “active feature” – that is, one search window and one feature window – to provide shift compensation only. Here are the assumptions for the example:

- The “workpiece” is a flat, stamped-out metal plate with a hole in the middle.
- The plate is frontlighted.
- The “feature” that the feature window will search for is a cross-shaped mark on the plate.
- The reference window will provide shift compensation to a linear gage.
- The linear gage will measure the diameter of the hole in the plate.
- The position of each plate in a series of inspections will vary somewhat horizontally and vertically, but will not rotate.

The practical objective in this example is for the CVIM system to inspect each plate for a hole of the proper diameter, and to reject all plates with either no hole, or one that is too small or too large.

The functions of the reference window in this example are these:

- Find the cross-shaped “feature” within the search window.
- Check whether the plate is *shifted* from the “original” or “taught” position.
- If a plate *is* shifted, shift the linear gage by the same *amount* and in the same *direction*.

Figure 6.5 shows how an image of the metal plate might appear on the video monitor.

Figure 6.5 also shows how the reference window is configured for this example. Both the search window and the feature window are *centered* over the feature. The reason is that the feature could be *anywhere* within the search window during a series of plate inspections.

Also, you would have set the feature window to a size just large enough to include the feature.

As the CVIM system inspects a series of plates, the feature window will find the feature on each plate *as long as* the feature appears *somewhere* within the search window.

If a particular plate is shifted, but the feature lies *within* the search window, the feature window will *find* the feature.

If the feature lies *outside* the search window, an inspection *failure* will occur, since the feature window will *not* be able to find the feature.

Using Reference Windows Shift-only Example (continued)
 (continued)

Figure 6.5 Single "Active Feature" Positioned Over Feature on Plate

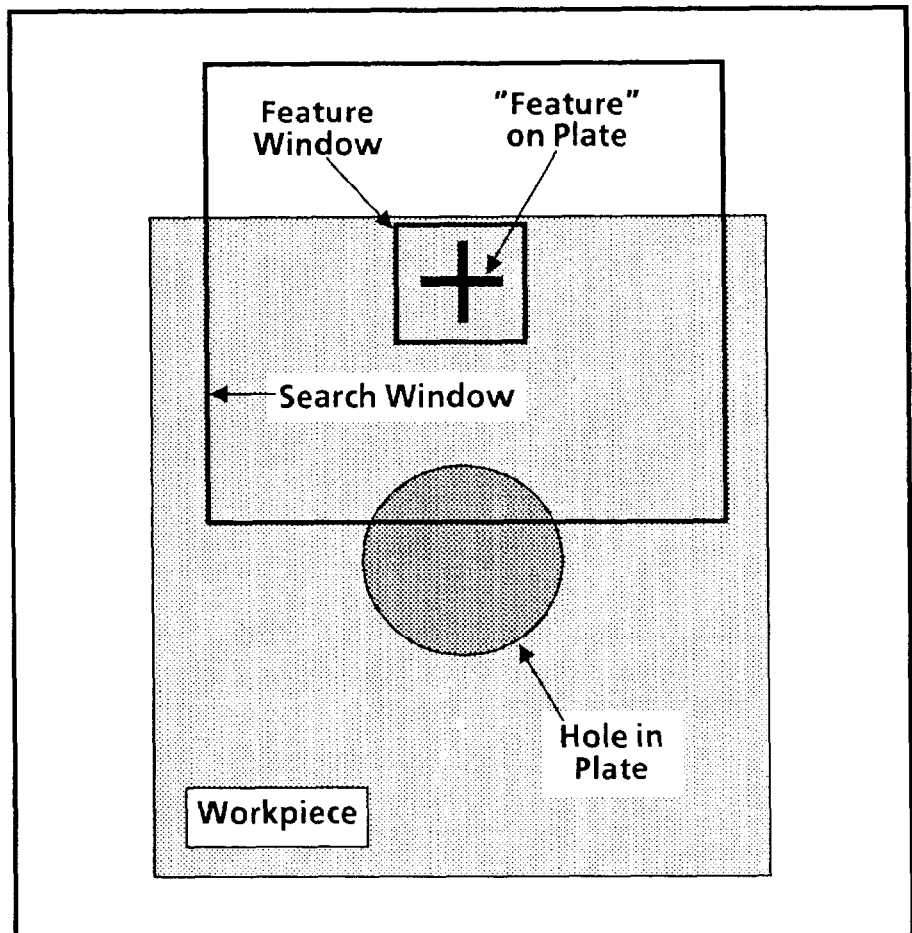

To summarize the main factors in the shift-only inspection example:

- One "active feature" – that is, one search window and one feature window – detects shift along the X and Y axes, and provides shift compensation (but not rotation) to a linear gage.
- The "feature" on the plate will always appear *somewhere* within the search window.
- The plate (and "feature") will not *rotate*.
- One linear gage will be used to measure the diameter of the hole in the plate.

Using Reference Windows
(continued)**Shift-only Example (continued)**

Figure 6.6 shows how the linear gage might appear when positioned horizontally across the hole; however, the gage *could* be positioned vertically, or at some angle, across the hole.

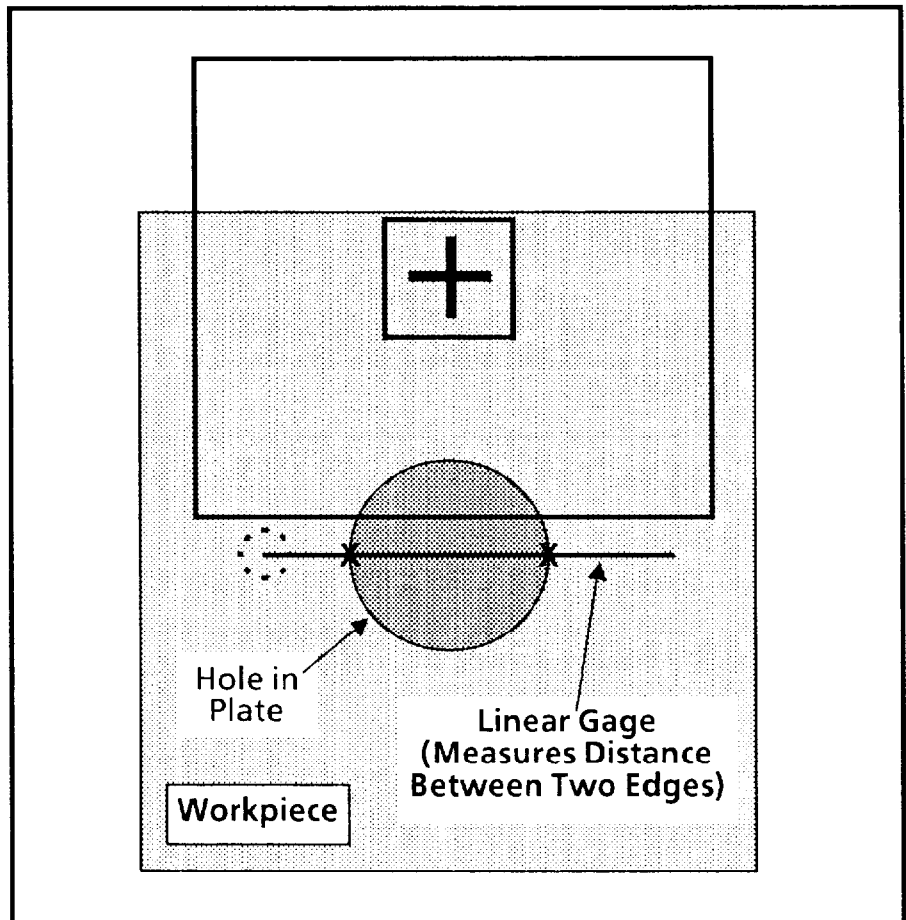
Figure 6.6 Linear Gage Positioned Over Hole in Plate

Whatever the gage's position across the hole, its length need only be sufficient to measure the *maximum* acceptable diameter. At that length, the gage could of course also detect the *minimum* acceptable diameter.

At the start of each inspection cycle, the feature window begins searching for the "feature" on the plate. It begins its search at the upper-left corner of the search window and proceeds left-to-right, top-to-bottom, toward the lower right corner, until it finds the feature.

Using Reference Windows
(continued)

Shift-only Example (continued)

Figure 6.7 compares the position of the "original" plate (the one used during configuration) to the position of a shifted plate (one that could appear during an inspection). Note that the plate, in this case, is shifted up and to the left.

Figure 6.7 Shifted Plate Compared to Original Plate

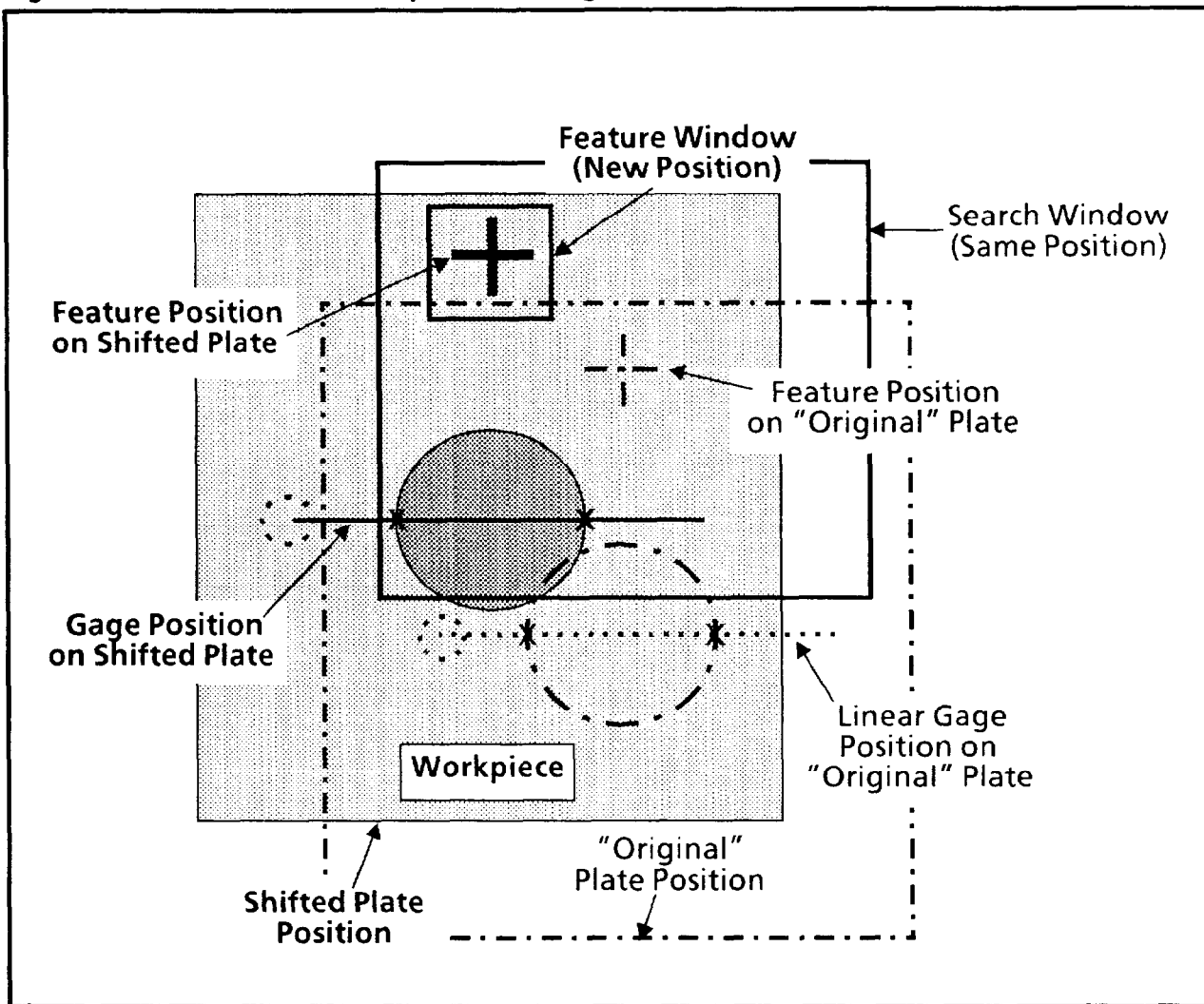

Note also that the "feature" on the shifted plate is still *within* the boundaries of the search window. Thus, the feature window was able to "find" the feature and supply shift compensation to the linear gage, as shown.

When the feature window finds the shifted plate's feature, the CVIM system compares its position with the "original" feature position. The difference between the two feature positions determines the amount of horizontal and vertical shift compensation applied to the linear gage. After the gage is shifted to its new position, it measures the hole diameter.

Using Reference Windows
(continued)**Shift-only Example (continued)**

Look again at Figure 6.7. Notice that *without* shift compensation the linear gage would be *below* the shifted hole, missing it completely. The result, in that case, would be an inspection failure.

Rotation and Shift Example

Figure 6.8 compares the position of the “original” plate (the one used during configuration) to the position of a rotated and shifted plate (one that could appear during a CVIM inspection). Note that the rotated plate, in this case, is rotated counter-clockwise and is shifted up and to the left.

Two “active features” are required to detect plate *rotation*.

One feature on the plate in Figure 6.8 is the cross or “plus” figure (+) in the upper-left corner; the other feature is the lower-right corner of the plate itself. Both features are unique on the plate.

Figure 6.8 Rotated and Shifted Plate Compared to “Original” Unrotated Plate

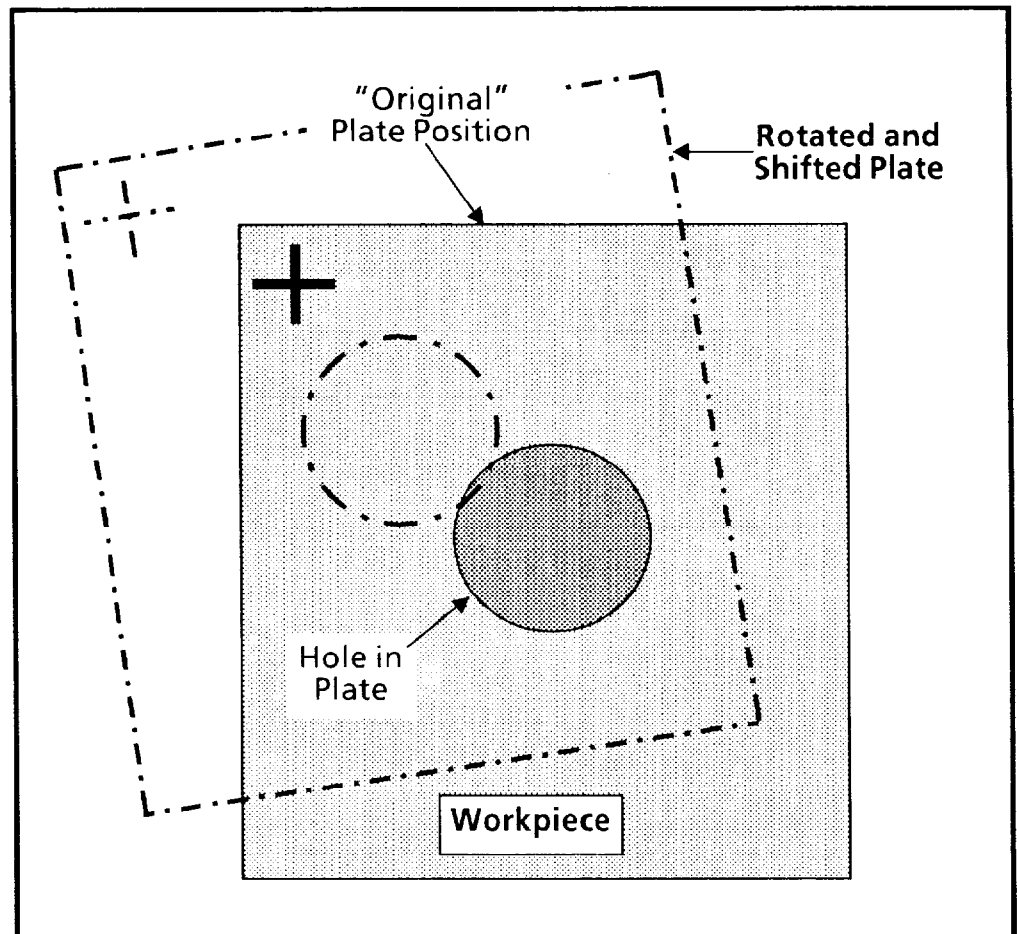

Using Reference Windows
(continued)

Rotation and Shift Example (continued)

Figure 6.9 shows how the two “active features” in this example are configured to detect shift and rotation.

- Each *feature* window is centered over the workpiece feature and is sized to include *only* the workpiece feature.
- Each *search* window is centered over the feature window and is sized to include the *maximum* acceptable plate shift and rotation.

Figure 6.9 Two “Active Features” Positioned Over Features on Plate

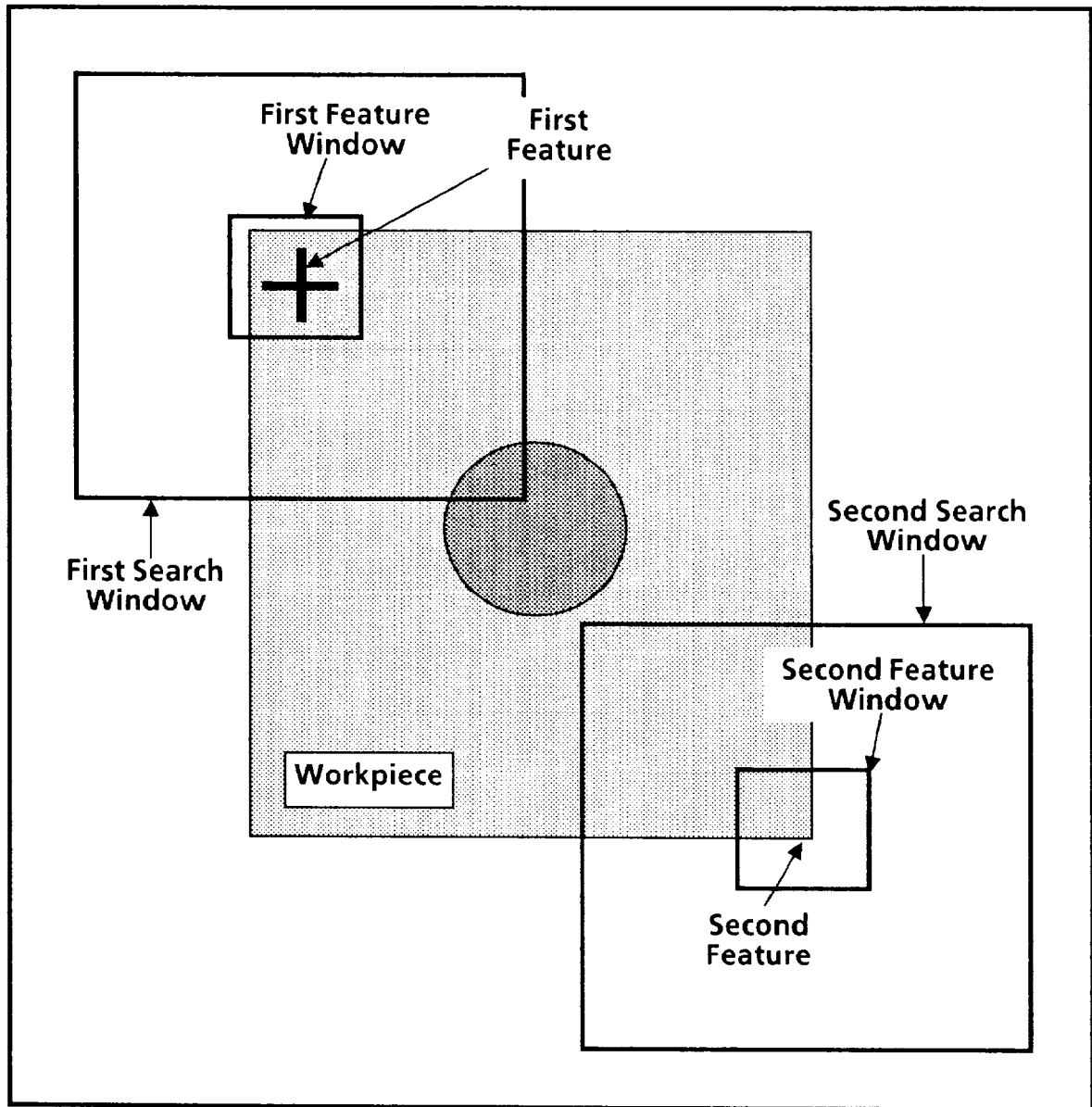

Using Reference Windows
(continued)**Rotation and Shift Example (continued)**

Figure 6.10 shows how the CVIM system uses the two active features to establish a *basic reference angle* for rotation compensation.

As the figure shows, the reference angle is the angle between the X-axis datum line and a datum line joining the centers of the features on the "original" unrotated plate.

NOTE: The two datum lines do not appear on the monitor screen. They are shown in the figure only for illustration.

Figure 6.10 Datum Lines and Reference Angle for Rotation Compensation

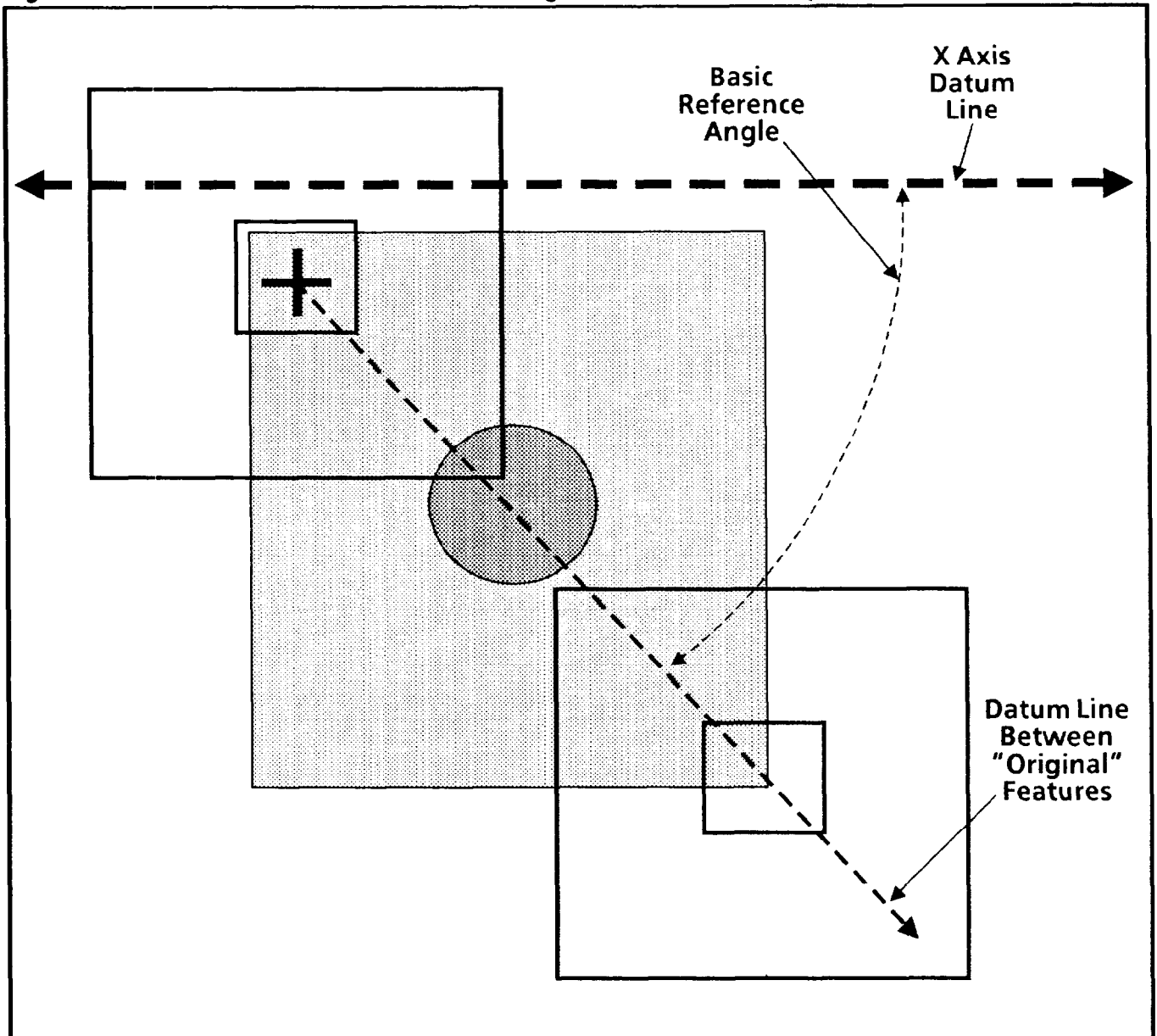

Using Reference Windows (continued)

Rotation and Shift Example (continued)

Figure 6.11 adds a rotated (and shifted) plate to Figure 6.10. This shows the relationship between the various datum lines and reference angles.

During an inspection cycle, the CVIM system compares the *reference angle* with the *rotation reference angle* (the angle between the X axis and the datum line for the rotated plate).

If these two angles differ, the system calculates the *rotation compensation angle*, which is the difference between the two angles in degrees, then rotates the associated inspection tool(s) according to the rotation compensation angle.

Figure 6.11 Basis for Determining Rotation Compensation

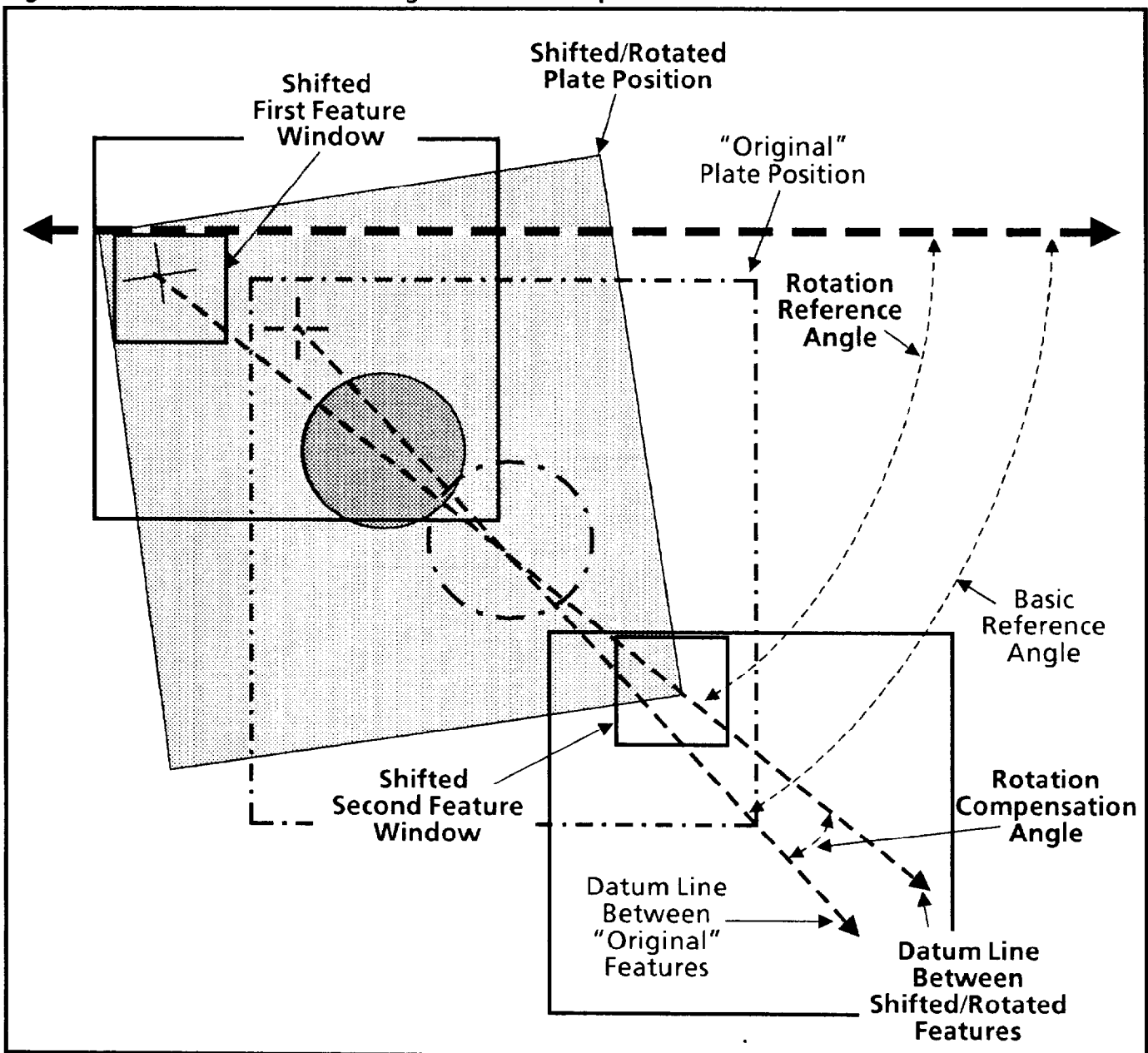

Using Reference Windows
(continued)**Rotation and Shift Example (continued)**

In Figure 6.11 the plate has rotated a few degrees counter-clockwise; thus, any associated inspection tool would also be rotated counter-clockwise the same number of degrees.

Figure 6.12 shows how CVIM uses the two "active features" to establish a *midpoint* for shift compensation.

As the figure shows, the midpoint is the halfway point on a line joining the centers of the two features on the "original" unshifted plate.

Note: The datum line does not appear on the video monitor screen. It is shown in the figure only for illustration.

Figure 6.12 Datum Line and Midpoint for Shift Compensation

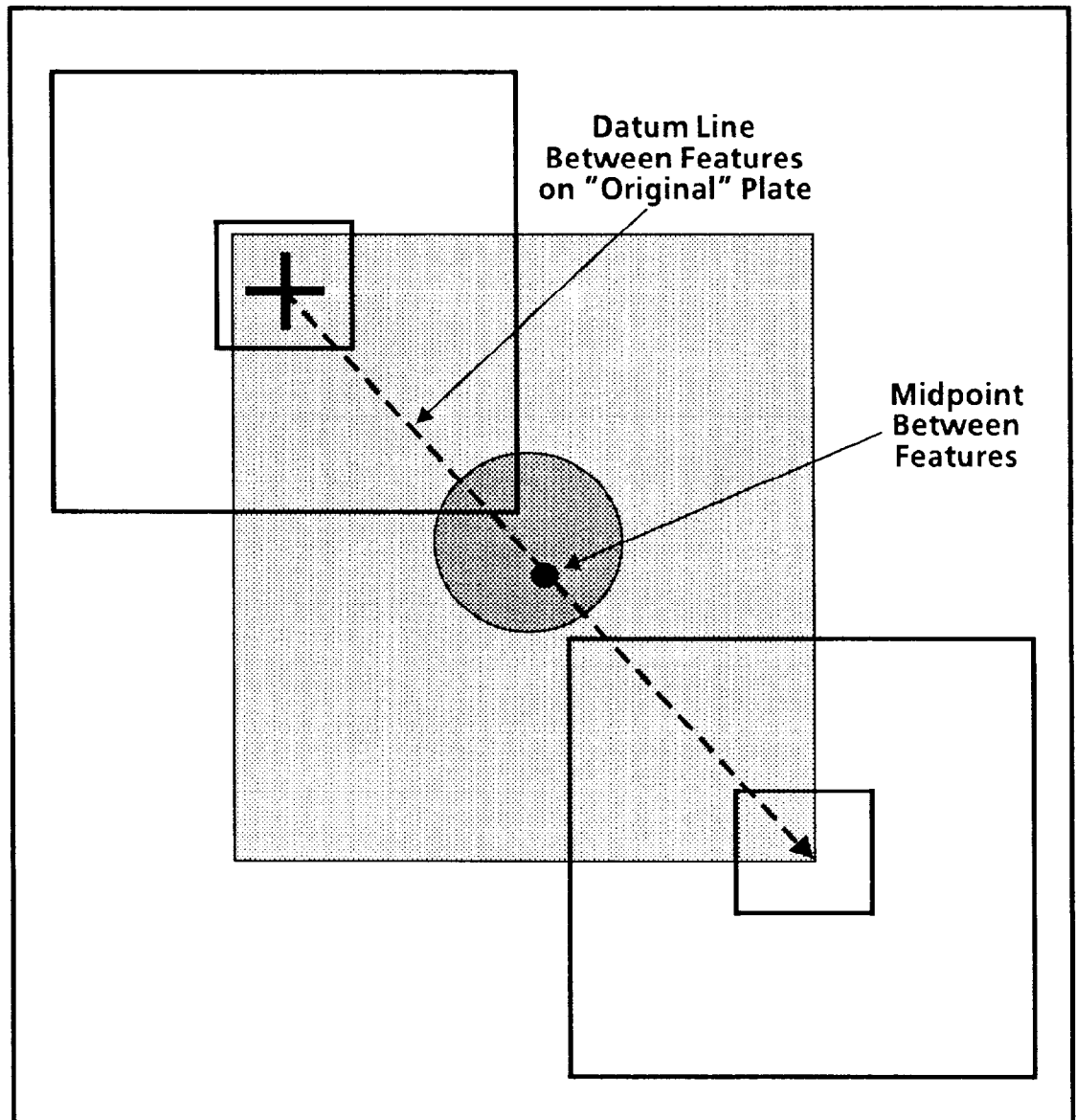

Using Reference Windows
(continued)

Rotation and Shift Example (continued)

Figure 6.13 adds a shifted (and rotated) plate to Figure 6.12. This shows the relationship between the two datum lines and their respective midpoints.

During an inspection, the CVIM system compares the "original" midpoint position with the shifted midpoint position.

If these two positions differ, the system calculates the X- and Y-coordinates of the *shifted* midpoint, then shifts the associated inspection tool(s) accordingly.

Figure 6.13 Basis for Determining Shift Compensation

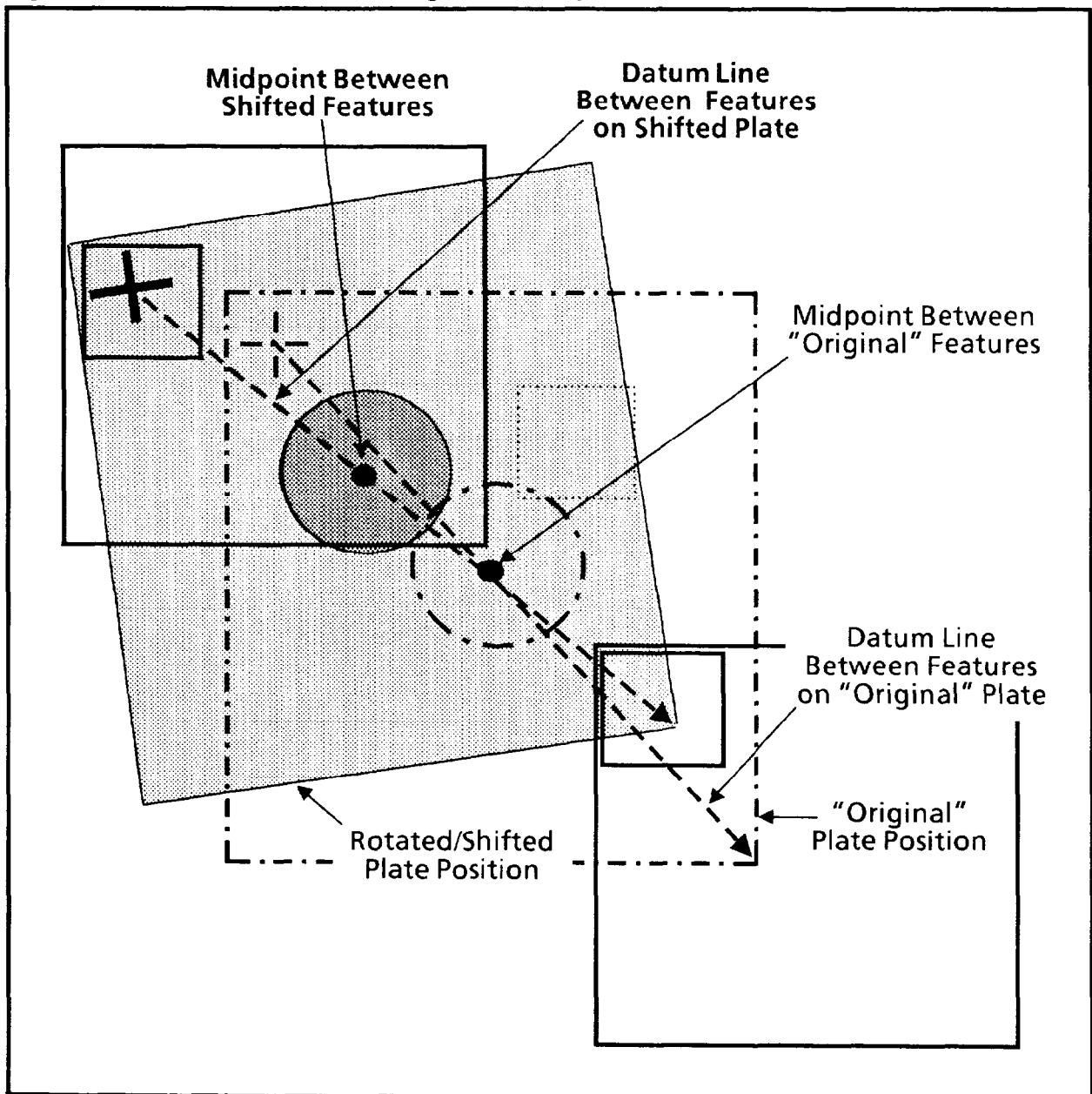

Selecting Workpiece Features

A reference window performs its function in a series of steps, as follows:

- It finds a *specific physical feature* on a workpiece.
- It determines the *location* (X- and Y-axis coordinates) of that feature.
- It calculates the *difference*, if any, between that feature's location and the location of the same feature on the "original" workpiece.
- It supplies any resulting shift and/or rotation compensation to all tools associated with the reference window.

Before you configure a reference window, you must select the specific physical feature(s) on the workpiece that you want the reference window to locate during an inspection cycle.

Here are some points to consider when you make that selection:

- **Minimize feature ambiguity:** The workpiece feature should be as *unique* as possible *within the search window* in order to reduce the probability of the *feature* window finding the *wrong* feature. As shown in the preceding figures, corners on a workpiece are often useable as features.
- **Maximize feature contrast and crispness:** The workpiece feature should have as much color *contrast* as possible between itself and its immediate background. Similarly, the feature should be *crisp*, not fuzzy, relative to its background.
- **Maximize feature solidity:** The workpiece feature should be as *solid* and *connected* as possible, with distinct characteristics. It should *not* be a disconnected collection of small pieces having an overall indistinct characteristic.
- **Minimize feature rotation sensitivity:** The workpiece feature should be as insensitive as possible to *rotation* in order to reduce the probability of the feature window not recognizing the rotated feature.

For example, a perfect circle should be fairly insensitive to rotation, whereas a more complex figure, such as upper-case "W," might be more easily missed if it is rotated.

- **Minimize feature window size:** The CVIM system regards *everything* inside the feature window as the "feature." Thus, you should make the feature window only as large as it must be to include the *workpiece feature* you've selected and as *little else as possible* on or around the workpiece. Minimizing the feature window's size reduces processing time.

The remaining pages of this chapter contain the procedures that you will use to configure a reference window.

Configuring Reference Windows

To configure the reference windows, you will pick the Ref. Win menu box in the Main Configuration menu, then select the parameters and perform the functions in the Ref. Win popup menu.

These are the main function and configuration categories in the Ref. Win popup menu:

- **Reference window features:** Selects and configures the search/feature window pairs (called "features"), sets the position and size of the search and feature windows, and sets the acceptance criteria for recognizing the searched-for feature(s) on the workpiece.
- **Output lines and reference tool:** Selects the output line for reporting inspection "results," and selects the reference tool from which to receive shift compensation.
- **Coordinates and angles:** This function "learns" the X- and Y-axis coordinates of the *center* of a single feature window or the *center point* between the centers of multiple feature windows.

The *center point* serves as a reference for measuring the angle between the positive X axis on the screen image and one of the feature windows.

- **Reference window number:** This function selects the reference window *number* (1, 2, or 3) to be configured.
- **Reference window enable/disable:** This function enables or disables the currently selected reference window.

Configuring a reference window involves these basic steps:

- Selecting the reference window number (1 to 3).
- Enabling the selected reference window.
- Selecting the feature(s) that you want the reference window(s) to find in the camera image.
- Positioning and sizing the reference window(s) over the workpiece image.
- Selecting the specific parameters for finding the feature(s).

Selecting Ref.Win Popup Menu

Your first step is to select the Ref.Win popup menu.

Your Action

Pick Ref.Win in the Main Configuration menu.

Comments

When you pick the Ref.Win, the Ref. Win background color changes from brown to black, and the Ref. Window popup menu appears above the Main Options list:

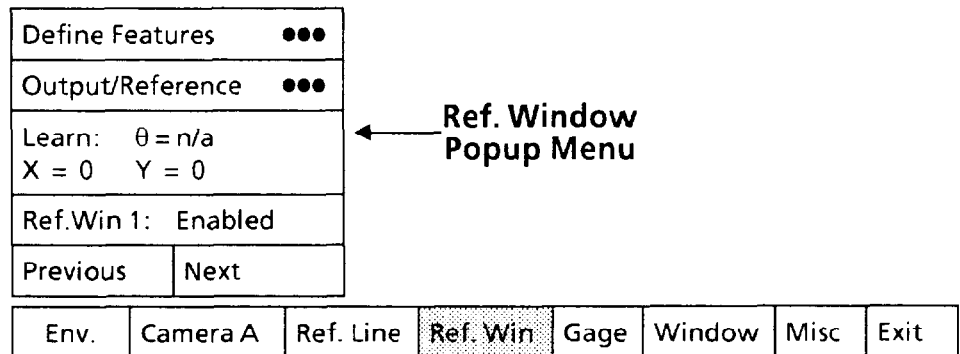

The Ref. Win popup menu shows the five configuration categories described earlier.

In addition to the popup menu, if the currently selected reference window is *enabled*, as shown above, the three feature windows will also appear on the screen.

Selecting and Enabling Reference Window

Select the reference window number and enable the reference window.

Your Action

Look at the Ref.Win menu box in the Ref.Window popup menu.

Comments

The Ref.Win box indicates the currently selected reference window number (1, 2, or 3). It also indicates whether that reference window is Enabled or Disabled.

Select the reference window number.

To change the reference window number, pick the Next (or Previous) menu box repeatedly until the correct number appears.

The Next and Previous functions work like this: When you pick the Next box, the next *higher* reference window number appears: 1, 2, 3, . . . 1, 2, 3, and so on. When you pick the Previous box, the next *lower* reference window number appears: 3, 2, 1, . . . 3, 2, 1, and so on.

Look at the Ref.Win menu box again.

If Disabled appears, perform the next step.

Pick the Ref.Win menu box.

To *enable* the reference window, pick the Ref.Win menu box. The status should now indicate Enabled.

**Selecting Define Features
Popup Menu and Parameters**

Select the Define Features popup menu, then select the parameters and functions in that menu. Basically, these parameters and functions specify the feature to be searched for and the area to be searched, and the degree to which the "found" feature matches the "original" feature.

Your Action

Pick the Define Features menu box in the Ref. Window popup menu.

Comments

When you pick the Define Features menu box, the Define Features popup menu appears above the Ref. Window popup menu. Initially, it appears as follows:

Save Feature							
P&P Feature Win. ●●●							
Feature Disp: Off							
Find Feature: -1							
Set Score: 0 ●●●							
Active Feature: 1							
Define Features ←							
Output/Reference ●●●							
Learn: $\theta = n/a$ X = 0 Y = 0							
Ref.Win 1: Enabled							
Previous				Next			
Env.	Camera A	Ref. Line	Ref. Win	Gage	Window	Misc	Exit

← Define Features Popup Menu

← Ref. Window Popup Menu

Selecting Active Feature

Each reference window has available three "active features," or window pairs, each of which consists of a *feature* window and a *search* window. These active features are numbered 1, 2, and 3.

Generally, only *one* feature is needed to provide shift compensation. If rotation compensation is necessary, two or three features are needed.

Use the next steps to select any one of the three features.

Your Action

Look at the Active Feature menu box in the Define Features popup menu.

Pick the Active Feature menu box, if appropriate.

Comments

The Active Feature menu box indicates the "feature" (that is, 1, 2, or 3) that is currently "active" for configuration purposes.

When you pick the Active Feature menu box, the "active feature" will advance to the next higher number.

Select whichever feature number you want to configure at this time.

**Selecting Define Features
Popup Menu and Parameters**
(continued)

Using P&P Feature Win. Function

Select the P&P Feature Win. menu box, then position the feature window over the *physical* feature on the workpiece and set the window to the appropriate size. (“P&P” means “pick and place.”)

NOTE: The feature window has a *minimum* size of 16 pixels by 16 pixels, and a *maximum* size of 64 by 64 pixels.

The following procedure shows you how to use the light pen to adjust the position and dimensions of a feature window.

Your Action

*Pick the P&P Feature Win.
menu box in the Define
Features popup menu.*

Comments

When you pick the P&P Feature Win. menu box, a small square (□) will appear in the center of the currently selected feature window and in the center of each side of that window, as follows:

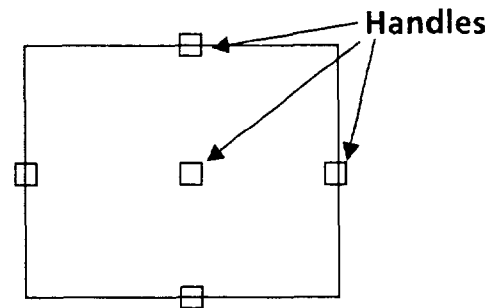

These squares are the “handles” that the light pen uses to manipulate the window on the monitor screen.

*Aim the light pen at the
center handle.*

Aim the light pen at the center handle until the light pen “sees” the handle. You may have to move the light pen around slightly.

When the light pen sees the handle, a larger “highlight” square will surround the handle, as follows:

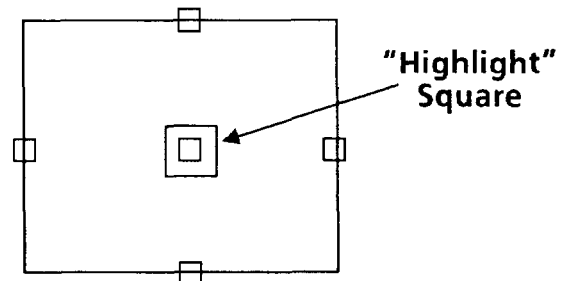

Hold the pen steady in this position – the appearance of the “highlight” square means that the light pen is now properly aimed.

**Selecting Define Features
Functions and Parameters
(continued)**

Using P&P Feature Win. Function (continued)

Your Action

Pick the handle.

Comments

A small "X" will appear in the center of the window, along with a "spotlight," which facilitates "dragging" the window.

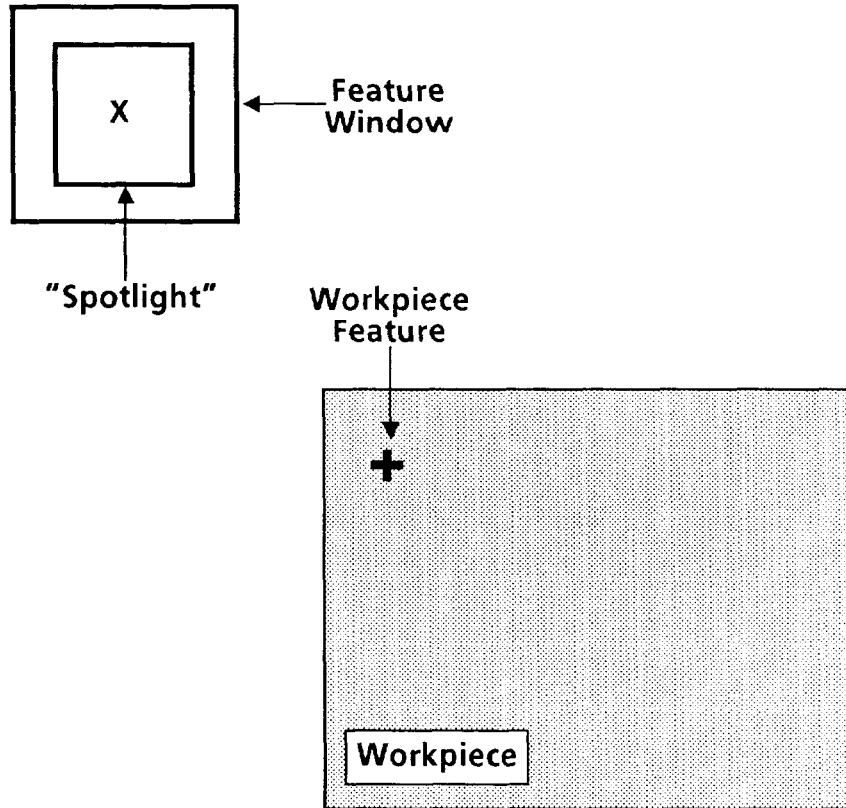

You can now "drag" the window across the monitor screen. When you move the pen, the entire window follows.

Selecting Define Features Functions and Parameters
(continued)

Using P&P Feature Win. Function (continued)

Your Action

Comments

Drag the feature window over the "+" workpiece feature.

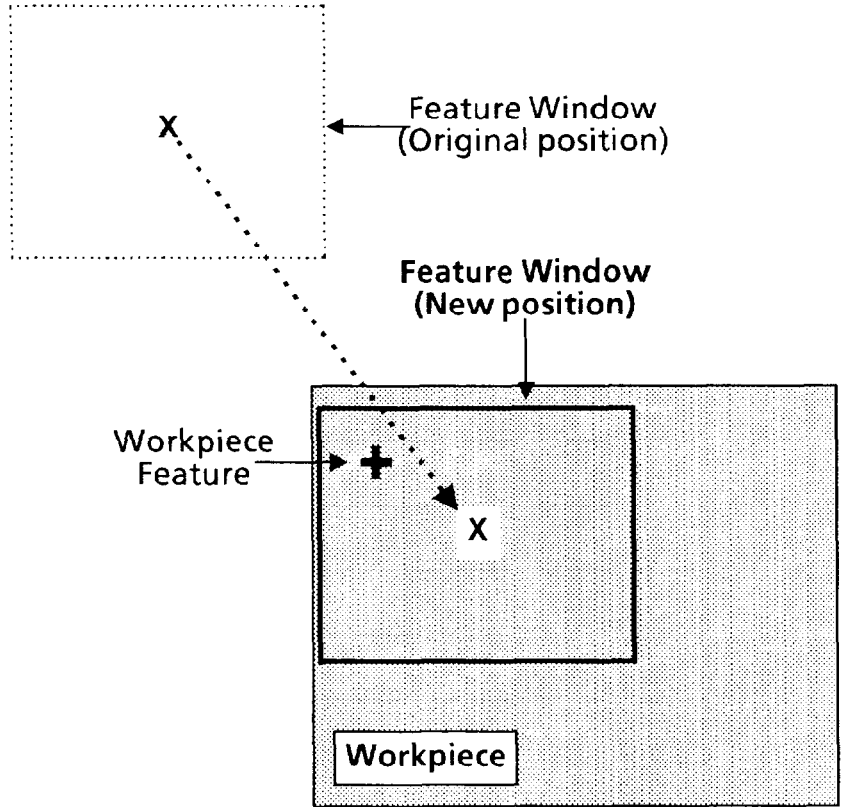

NOTE: Keep the tip of the pen within about one-half inch of the monitor screen.

When you have the window in position over the workpiece feature, press the pen against the monitor screen to "lock" the window at that position.

Aim the light pen at the rightmost handle.

Continue when the highlight square appears.

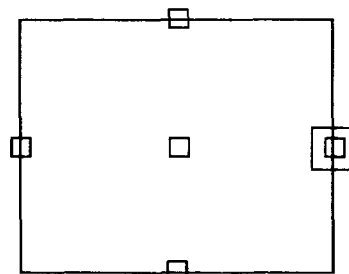

**Selecting Define Features
Functions and Parameters**
(continued)

Using P&P Feature Win. Function (continued)

Your Action

Pick the handle.

*Drag the right side of the
window as shown.*

Comments

Note that the *left* side remains anchored.

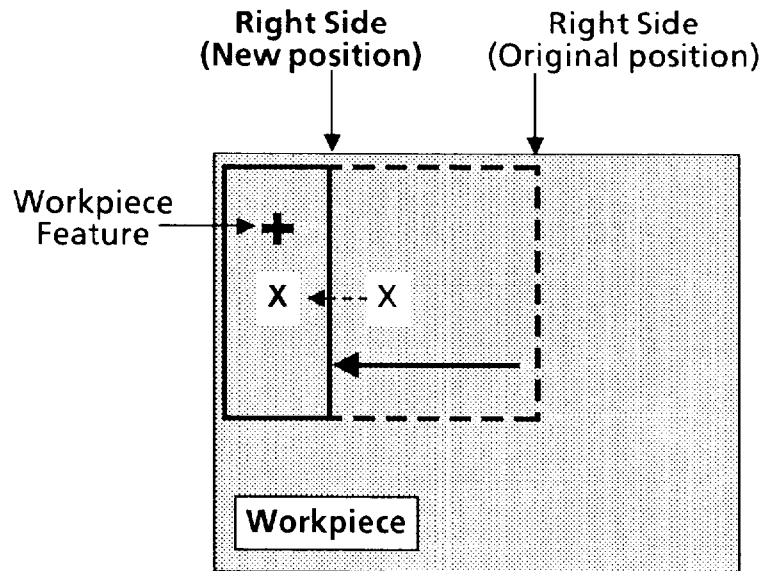

*Lock the window's right side
in position.*

*Aim the light pen at the
bottom handle.*

Continue when the highlight square appears.

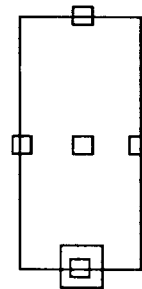

Pick the handle.

Selecting Define Features Functions and Parameters (continued)

Using P&P Feature Win. Function (continued)

Your Action

Drag the bottom side up
as shown.

Comments

Note that the *top* side remains anchored.

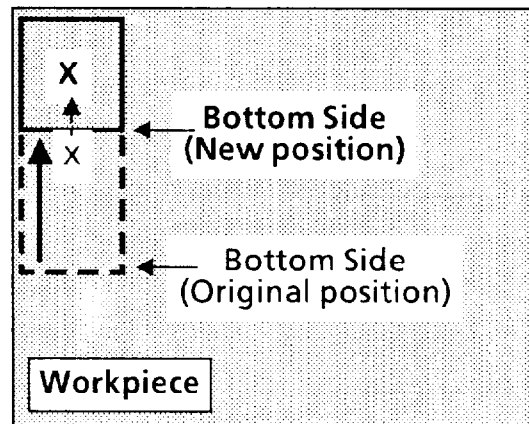

Lock the window's bottom
side in position.

The feature window is now properly positioned over the workpiece feature.

If necessary, use the vernier
arrows to "fine-tune" the
position or size of the window.

You can change the window's size or position more *precisely* by using the *vernier* arrows. The vernier arrows enable you to make these changes in small increments.

You can access the vernier arrows while either *picking* a window handle or *placing* the window or window side.

Press and hold the light pen tip
against the window handle,
window, or window side.

Hold the light pen tip in for about *one second*. The vernier arrows will then appear in the lower-right corner of the monitor screen:

VERNIER ARROWS

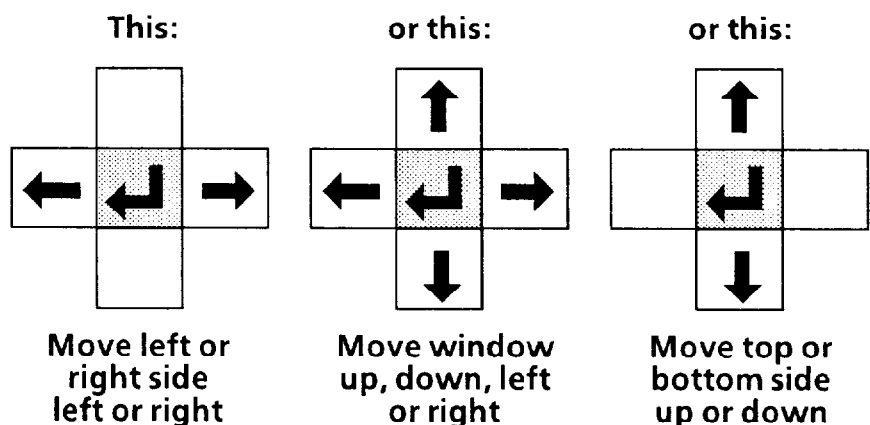

Selecting Define Features Functions and Parameters (continued)

Using P&P Feature Win. Function (continued)

Your Action

Comments

Pick an arrow once to move the window or window side one pixel in the arrow's direction.

The up, down, right, or left arrow, will move the entire window or window side *one pixel* in the direction indicated by the arrow.

Pick and hold an arrow to change the window size or position continuously.

When you pick and *hold* an arrow, the window's size or position will change slowly for the first five or six increments. It will then change at a more rapid rate.

Pick the "return" symbol to release the vernier arrows.

When the window or side is properly positioned, pick the "return" symbol (↵) to *release* the vernier arrows and return to the standard pick-and-place mode.

Pick the Save Feature menu box.

This saves the contents (the workpiece feature) of the feature window.

When you pick the Save Feature menu box, the *search* window will appear centered around the feature window, as follows:

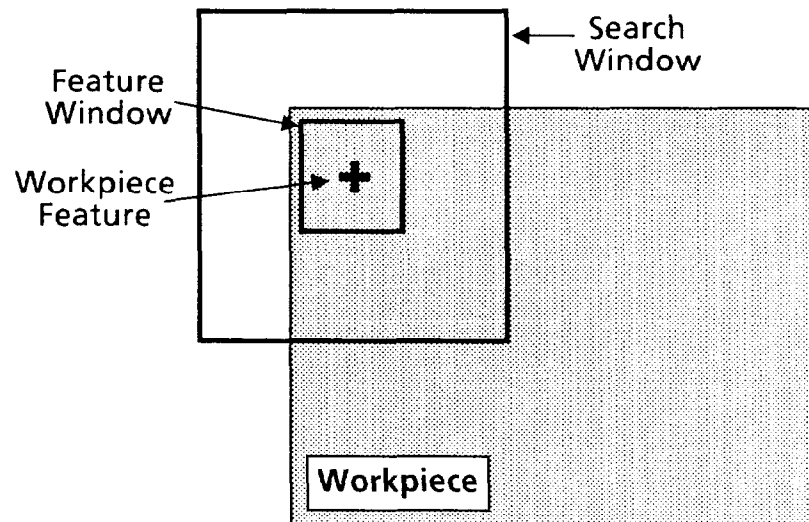

**Selecting Define Features
Functions and Parameters
(continued)**

Using P&P Feature Win. Function (continued)

Your Action

Comments

In addition, the following changes will occur in the Define Features popup menu:

- The term Save Feature will change to Delete Feature.
- The P&P Feature Win. menu box will change to P&P Search Win.
- The three menu boxes, Feature Disp, Find Feature, and Set Score are *enabled*; that is, the type changes from black to light, indicating that you can now pick these boxes.

At this point, the system is enabled for configuring the *search* window and for setting the feature-matching tolerance level (called "score").

Using Feature Disp Function

The Feature Disp function enables you to display the contents of the feature window on the monitor screen.

Your Action

Comments

*Look at the Feature Disp
menu box.*

The Feature Disp menu box indicates the *status* of the Feature Disp function, which will be either on or off.

*Pick the Feature Disp
menu box, if appropriate.*

If the Feature Disp function is *on* and you want it *off*, or vice versa, pick the menu box. If you set the status to *on*, the feature window and its contents will appear at the right edge of the monitor screen.

Using P&P Search Win. Function

Pick the P&P Search Win. menu box, then position the search window around the feature window and set the search window to the appropriate size.

NOTE: The search window can be adjusted to include almost the *entire screen image*; however, it is unlikely that your application will require that size. If so, the processing time would be increased.

The procedure for adjusting the size and position of a search window are the same as for the feature window.

**Selecting Define Features
Functions and Parameters
(continued)**

Using P&P Search Win. Function (continued)

Your Action	Comments
<i>Look at the search window.</i>	As noted earlier, the search window centered itself around the feature window when you saved the feature window. The search window should be just large enough to permit the feature window to find the feature with the maximum allowable shift and/or rotation appropriate for your application.
<i>If necessary, adjust the size and position of the search window.</i>	Use the same “pick and place” procedure that you used to set the feature window’s position and size.

Understanding Set Score Function

During an inspection cycle, the feature window searches within the search window for a workpiece feature that matches the *stored* workpiece feature – the one that you “saved” in the CVIM system memory with the Save Feature function.

The feature window conducts its search starting at the top-left corner of the search window and proceeding left-to-right and top-to-bottom. Along the way, it examines each area for a pattern of pixels that matches *most closely* the pixel pattern (that is, the *workpiece feature*) in the *stored* feature window.

As the feature window examines each new area, it accumulates a numerical *score* that indicates how much the pixel pattern in the *present* area *differs* from the pixel pattern in the *stored* feature window. The higher the accumulated score, the greater the difference or “error.”

If the accumulated score (“error”) *equals or exceeds* the value entered in the Set Score menu box, the feature window will *stop* examining the present area and will move to the *next* area, where it will begin examining the pixel pattern and accumulating a new score.

If the feature window encounters an area in which the total accumulated score is *lower than* the value in the Set Score menu box, it will then examine the *next* area to see if that area will yield an even *lower* score. If so, the feature window will continue further; if not, it will go back to the area with the *best* – that is, the *lowest* – score. In either case, since the feature window has *located* the workpiece feature, it stops the search.

If the feature window fails to find *any* area within the search window in which the accumulated score is lower than the Set Score value, the *entire* reference window will fail.

**Selecting Define Features
Functions and Parameters**
(continued)

Determining Set Score Value

In order to determine the appropriate score value(s) to enter into the Set Score menu box(es), you must perform a series of trial inspections, using several representative workpieces. This will provide you with a base of "score" statistics from which you can derive the appropriate score value(s).

At this point, you should have several representative workpieces on hand for use in the trial inspection series.

Before beginning the trial inspections, be sure to stage your "ideal" workpiece in front of the camera and perform all of the appropriate parameter settings and functions described in Chapters 3, 4, and 5. Then, position the feature and search windows over the appropriate *workpiece feature* for each active feature (in each reference window) as described earlier in this chapter.

NOTE: In choosing *workpiece features*, it is very desirable to use those that are *unique* within a search window and have *consistent appearance* from workpiece to workpiece. This allows using *low* score values. Features whose appearance *varies slightly* from workpiece to workpiece will require using *higher* score values. Although higher score values allow the CVIM system to locate varying features, the cost is a slight increase in processing time and a potential decrease in location accuracy.

Your first step in preparing for the trial inspections will be to enter a score of 0 (zero) in the Set Score menu box. A score value of 0 has a special effect: During each inspection cycle, the feature window will search the *entire* search window for the *best* match.

Next, you will arrange your workpieces so that the CVIM system can inspect them. The inspection setup can be either a manual one, in which you place each new workpiece in position and press a trigger button, or an automatic one, in which you use the actual factory equipment or simulate it.

When the inspection setup is ready, you will set the CVIM system to the *run mode* (described in Chapter 10). This enables the CVIM system to perform the inspections. During each inspection cycle, the feature window searches the entire search window for the *best* match and reports the resulting *score* to the statistics tables.

During the inspection series, you should reposition (if necessary) some of the workpieces in order to create the *maximum* workpiece shift and/or rotation that you expect to occur in your application.

Finally, when the CVIM system has performed a sufficient number of inspections, you can end the run mode. The *score results* now stored in the statistics tables will be your basis for determining the *score value(s)* to enter into the Set Score menu box(es).

**Selecting Define Features
Functions and Parameters
(continued)**

Determining Set Score Value (continued)

You can determine the appropriate score value to enter into a particular Set Score menu box by examining the Maximum score "reading" in the associated Inspection Statistics table (you will see this table when you pick the Set Score menu box). To this "reading" you will add a 10% margin. For example, if the Maximum score reading were 40, you would add 10%, or 4, resulting in 44. This is the score value that you would enter into the Set Score menu box.

The score value has consequences affecting the *repeatability*, *reliability*, and *location accuracy* of a feature window, as follows:

- *Repeatability* – This indicates how *consistently* the feature window finds a feature in the search window. Repeatability is 100% if the feature window *always* finds a feature (however, it may *not* always find the *correct* feature).

Generally, the higher the score value, the higher the probability that the feature window will find a particular workpiece feature *every time*. At the same time, however, the probability also increases that the feature window may find a *spurious* "feature." For example, very high score values, such as 200, will enable the feature window to accept nearly *anything* in the search window as the "correct" workpiece feature.

- *Reliability* – This indicates how well the feature window finds the *correct* workpiece feature. Reliability is 100% if the feature window finds *only* the *correct* feature (however, it may *not* always *find* that feature).

Generally, the lower the score value, the higher the probability that the feature window will find *only* the *correct* workpiece feature. At the same time, however, the probability also increases that the feature window may not find *any* feature. For example, very low score values, such as 5, may restrict the feature window to accepting *only* the *correct* workpiece feature, but it may *not* necessarily find that feature *every time*.

- *Location accuracy* – This indicates how accurately the feature window locates the position of the workpiece feature on the X and Y axes.

Generally, the lower the score value, the higher the location accuracy, and vice versa. Reductions in accuracy are slight, however, and for most tool operations they will have no material effect.

**Selecting Define Features
Functions and Parameters**
(continued)

Determining Set Score Value (continued)

As you can see from the preceding discussion, you will need to consider certain trade-offs before setting the score value. For example, if the workpiece feature you've selected yields a high Maximum reading in the statistics tables, you may still be able to use that workpiece feature so long as the search window will never contain another object that the feature window can mistake for the *correct* feature.

Alternatively, you may be able to *reduce* the Maximum score reading by positioning the feature window differently over the workpiece feature, or by using a workpiece feature with a simpler shape, such as a circle.

In all cases, you should try to find the combination of workpiece feature and feature window size and position that yields the lowest score possible within the constraints of your application.

The following table summarizes the effects that the various score values have on the repeatability, reliability, and location accuracy factors.

Score Value	Repeatability	Reliability	Location Accuracy	Comments
0	Maximum	Maximum	Maximum	This score value causes feature window to search entire search window and report lowest score (that is, best match).
1-30	Fair	High	Excellent	Appearance of workpiece feature uniform on all workpieces, even when rotated. Feature window is least likely to find a spurious feature. Good when search window has objects similar to workpiece feature.
30-50	Good	Very Good	Very good	Appearance of workpiece feature varies slightly. Feature window is more likely to find a spurious feature if search window contains objects similar to workpiece feature. OK if search window has no other objects that feature window can mistake for correct workpiece feature.
50-100	Very Good	Good	Good	Appearance of workpiece feature varies significantly. Feature window is likely to find a spurious feature if search window contains other objects. OK if search window has no other objects.
100 +	High	Fair	Fair	Appearance of workpiece feature varies greatly. Feature window is very likely to find a spurious feature if search window has other objects. May be OK if search window contains no other objects.

Selecting Define Features Functions and Parameters (continued)

Determining Set Score Value (continued)

Use the following procedure to determine the appropriate score value for an active feature.

Your Action

Look at the Set Score menu box in the Define Features menu.

Pick the Set Score menu box in the Define Features popup menu.

Comments

If the score value is *not* already 0 (zero), perform the next three steps to set the score value to 0. This is necessary before you begin the series of trial inspections.

When you pick the Set Score menu box, the calculator pad and the Inspection Statistics table appear, as follows:

The screenshot displays the software interface with several components highlighted:

- Define Features Menu:** A vertical list of options including "Delete Feature", "P&P Search Win.", "Feature Disp: Off", "Find Feature: -1", "Set Score: 55" (highlighted with a left arrow), "Active Feature: 1", "Define Features" (highlighted with a left arrow), "Output/Reference", "Learn: $\theta = n/a$, $X = 0$, $Y = 0$ ", "Ref. Win 1: Enabled", and "Previous/Next" buttons.
- Inspection Statistics Table:** A table with the following data:

Nominal	-1
Samples	324
Maximum	49
Minimum	12
Mean	28.267
Std. Dev	5.498
- Calculator Pad:** A numeric keypad with digits 0-9, a decimal point, and function keys: "+", "-", "%", "X", "/", "=", "←", "Clr", and "Enter". The display shows the number "55".
- Ref. Window Popup Menu:** A horizontal menu at the bottom with options: "Env.", "Camera A", "Ref. Line", "Ref. Win" (highlighted with a left arrow), "Gage", "Window", "Misc", and "Exit".

Note that the *current* "score" setting (55) in the Set Score menu box appears in the calculator display. Note also that the current statistics in the Inspection Statistics table is from a *previous* operation that used "active feature" #1.

Pick the 0 (zero) digit.

When you pick the 0 digit, it will appear in the calculator display.

Pick the Enter key.

When you pick the Enter key, the 0 will appear in the Set Score menu box. *The score value is now set to 0.*

Repeat the preceding steps for each active feature used in your application.

Selecting Define Features Functions and Parameters (continued)

Determining Set Score Value (continued)

Your Action	Comments
Prepare to run a series of "trial" inspections.	Refer to Chapter 10, <i>Runtime Operations</i> for more details about the following steps.
Pick the Exit menu box in the Main Configuration menu.	When you pick the Exit menu box, the Exit popup menu will appear.
Pick the Runtime Init. menu box in the Exit menu.	When you pick the Runtime Init. menu box, the Runtime Init. popup menu will appear.
Look at the Mode menu box in the Runtime Init. menu.	If "Standard" appears, pick the menu box <i>once</i> to toggle it to "Learn." This activates the "learn" mode during the trial inspection series and ensures the accumulation of "score" data in the statistics tables.
Pick the Runtime Display menu box in the Exit menu.	When you pick the Runtime Display menu box, the Runtime Display popup menu will appear.
Pick the Stat. Page 2 menu box in the Runtime Display menu.	The Stat. Page 2 menu box causes page two of the statistics tables to appear on the monitor screen when you activate the run mode. Page two displays "score" statistics for all <i>enabled</i> reference windows.
Pick the Runtime menu box in the Exit menu.	When you pick the Runtime menu box, the Runtime popup menu will appear.
Pick the Goto Runmode menu box in the Runtime menu.	When you pick the Goto Runmode menu box, the CVIM system will begin running inspections <i>if you selected Auto/Internal as the trigger source</i> . If not, the system will await trigger inputs from whatever trigger source you selected.
Look at the statistics table.	As the inspections continue, the Stat. Page 2 table will display accumulated "score" data <i>only</i> for each "active feature" within each <i>enabled</i> reference window. <i>No</i> data will appear for any "feature" or window that is <i>not</i> enabled.
Reposition your workpiece to cover all <u>possible</u> positions in your application.	The purpose of doing this is to accumulate "score" data from the worst-case positions that can occur in your application.
When you have <u>enough</u> inspections, look at the Max Reading scores in the Stat. Page 2 table.	The Max Reading scores in the Stat. Page 2 table are the worst-case scores for each of the "active features" in each <i>enabled</i> reference window.
Pick the Setup menu box to <u>stop</u> the runmode.	These scores are the basis for the <i>initial</i> values that you will use in the Set Score menu box for each "active feature." The CVIM system will return to the configuration mode.
	At this time, the <i>final</i> data appearing in the Stat. Page 2 table are recorded in the Inspection Statistics table for each "active feature." You saw an example of this table when you picked the Set Score menu box earlier.

Selecting Define Features Functions and Parameters
(continued)

Using Set Score Function

Pick the Set Score menu box, then enter the *adjusted* Maximum score “reading” as the score value.

Recall from an earlier discussion that the *adjusted* score value is the Maximum score “reading” in the Inspection Statistics table, plus a 10% margin.

Your Action

Comments

Return to the Define Features popup menu.

Pick the Ref.Win menu box to get the Ref.Window popup menu, then pick the Define Features menu box to get the Define Features popup menu. This will restore the configuration situation existing before you performed the series of inspections.

Look at the Active Feature selection number.

Verify that the current “active feature” is one that you want to configure at this time (#1, #2, or #3).

Pick the Set Score menu box in the Define Features popup menu.

When you pick the Set Score menu box, the calculator pad and Inspection Statistics table appear, as follows:

The screenshot shows the software interface with several components:

- Define Features Popup Menu:** A vertical list of options including 'Delete Feature', 'P&P Search Win.', 'Feature Disp: Off', 'Find Feature: -1', 'Set Score: 0', 'Active Feature: 1', 'Define Features', 'Output/Reference', 'Learn: $\theta = n/a$, $X = 0$, $Y = 0$ ', 'Ref.Win 1: Enabled', and 'Previous/Next' buttons.
- Inspection Statistics Table:** A table with the following data:

Nominal	-1
Samples	411
Maximum	17
Minimum	1
Mean	16.316
Std.Dev	2.690
- Calculator Pad:** A numeric keypad with digits 0-9, a decimal point, and function keys: '+', '-', '%', 'X', '/', '=', '←', 'Clr', and 'Enter'.
- Ref. Window Popup Menu:** A horizontal menu at the bottom with options: 'Env.', 'Camera A', 'Ref. Line', 'Ref. Win', 'Gage', 'Window', 'Misc', and 'Exit'.

Note that the calculator “display” still shows the zero “score” setting that you set previously. Note also that the Inspection Statistics table displays a Maximum “reading” of 17. In this case, you would add 10% (rounded) to 17, which would yield an adjusted score value of 19.

Enter each digit of your adjusted score value.

**Selecting Define Features
Functions and Parameters
(continued)**

Using Set Score Function (continued)

Your Action

Comments

Pick the Enter key.

When you pick the Enter key, the new score value will appear in the Set Score menu box.

NOTE: You should think of the score value that you just entered as its *initial* value. It is thus subject to change, as may be indicated when you run additional series of trial inspections.

Ultimately, the *best* score value is the *lowest* one that ensures the most efficient and reliable feature-search operation. The trade-off for using higher scores is a slight increase in processing time and a potential decrease in reliability and/or accuracy.

Repeat the Set Score function for each "active feature" to be used in your application.

Using Find Feature Function

The Find Feature function causes the feature window of the *current "active feature"* (1, 2, or 3) to conduct *one* search operation, using the *stored* image, and to report the result in the Find Feature menu box.

This function can be useful in troubleshooting your application, especially during the development stage.

For example, you could configure the CVIM system to halt on a reject. When a reject condition occurs, you could then analyze the image associated with the reject, determine the score that caused the reject, and possibly determine the cause of the excessive score.

Your Action

Comments

Set the Set Score value to 0 (zero).

Setting the score to 0 enables the feature window to search the *entire* search window for the *best* match; that is, the *lowest* score value.

Look at the Find Feature menu box.

Initially, the score is -1. This is a "flag" indicating that the Find Feature function has not been used since the current "active feature" (1, 2, or 3) was selected.

Pick the Find Feature menu box.

When you pick the Find Feature menu box, the feature window searches the entire search window for the workpiece feature. As noted above, the camera does *not* acquire a new image – the last stored image is used.

**Selecting Define Features
Functions and Parameters
(continued)**

Using Find Feature Function (continued)

Your Action

Comments

If the feature window *finds* the workpiece feature *before* accumulating a score exceeding 200, it returns the accumulated score value in the Find Feature menu box.

If the feature window cannot find *any* feature in the search window having an accumulated score below 200, a message appears on the monitor screen, as follows:

The feature cannot be located as currently configured.

Using Learn Function

Select the Learn menu box to command the CVIM system to “learn” the X-Y coordinates of the “shift reference point” and the angle of the “rotation reference line.”

The *shift reference point* is always stated in pixels from the *left* side of the screen image for X, and from the *top* of the screen image for Y. Thus, X = 120 indicates that the shift reference point on the X-axis is 120 pixels from the left, and Y = 75 indicates that the shift reference point is 75 pixels from the top.

The *rotation reference line* indicates the angle (θ) in degrees between itself and the positive X axis on the screen image. It appears only when two or three feature windows are used. The rotation reference line extends from the center point between the feature window centers (the *shift reference point*) and the center of one of the feature windows.

The following three figures show these shift reference points and rotation reference lines where one, two, or three feature windows are used.

When *one* active feature is used, the shift reference point is at the center of the feature window.

ONE ACTIVE FEATURE:

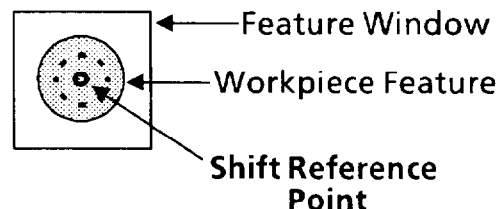

Using Learn Function
(continued)

When *two* active features are used, the shift reference point is halfway between the feature window centers. The rotation reference line extends from the shift reference point to the center of the *lowest* numbered feature window.

TWO ACTIVE FEATURES:

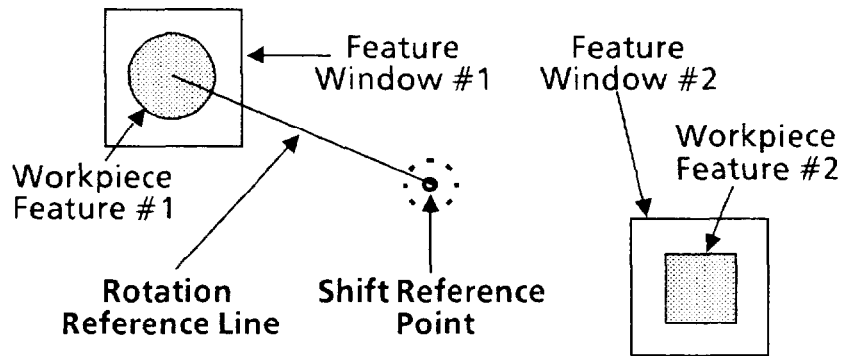

When *three* active features are used, the shift reference point is at the center of the triangle formed by the centers of the three feature windows. The rotation reference line extends from the shift reference point to the center of the *farthest* feature window.

In the figure below, feature window #1 is farthest from the shift reference point.

THREE ACTIVE FEATURES:

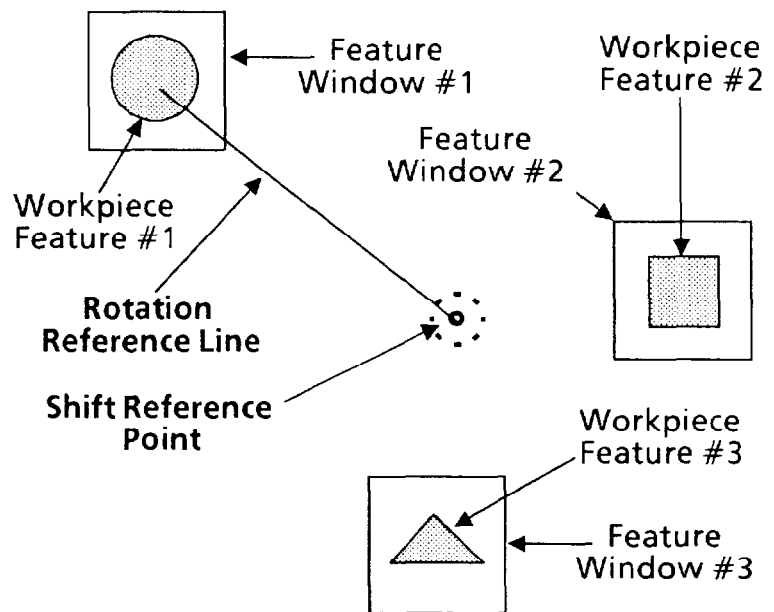

Using Learn Function
(continued)

The *angle* is always measured from the positive X axis, as follows:

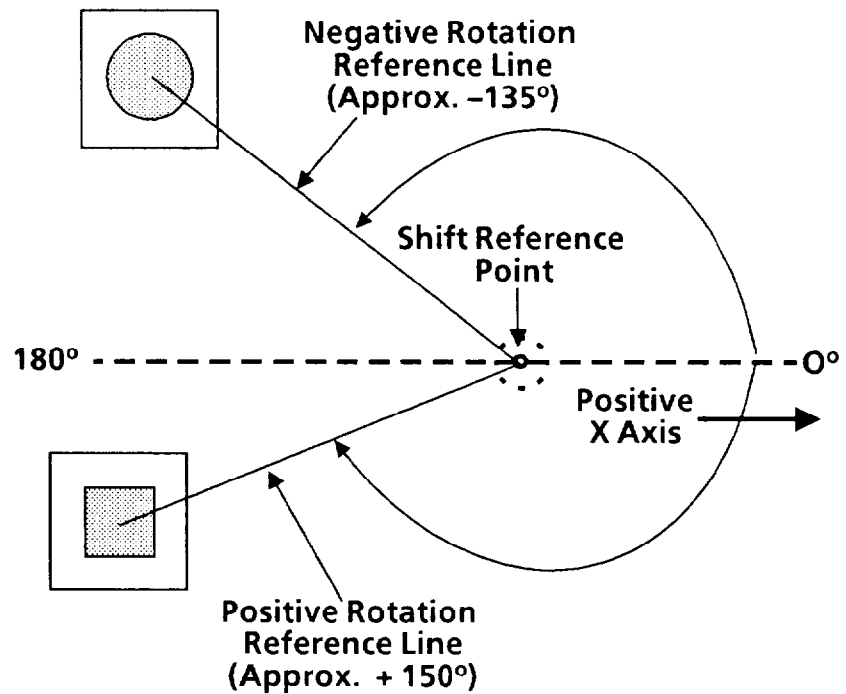

Notice that the three o'clock position is 0° , and the nine o'clock position is 180° . The maximum *positive* angle is 180.00° , and the maximum *negative* angle is -179.99° .

Your Action

Pick the Learn menu box.

Look at the new data in the Learn menu box.

Comments

When you pick the Learn menu box, the reference window "learns" the θ angle and the coordinates of the shift reference point, and it displays these figures in the menu box. Note that if you selected only *one* active feature, the angle line in the menu box will display $\theta = n/a$, or "not applicable."

The new data indicate the current angle (θ) between the screen image X axis and the rotation reference line, and the X and Y coordinates of the shift reference point.

Selecting Output/Reference Popup Menu and Parameters

Select the Output/Reference popup menu, then select the parameters in that menu.

Your Action

Comments

Pick the Output/Reference menu box in the Ref.Win popup menu.

When you pick the Output/Reference menu box, the Output/Reference popup menu appears above the Ref.Win popup menu, as follows:

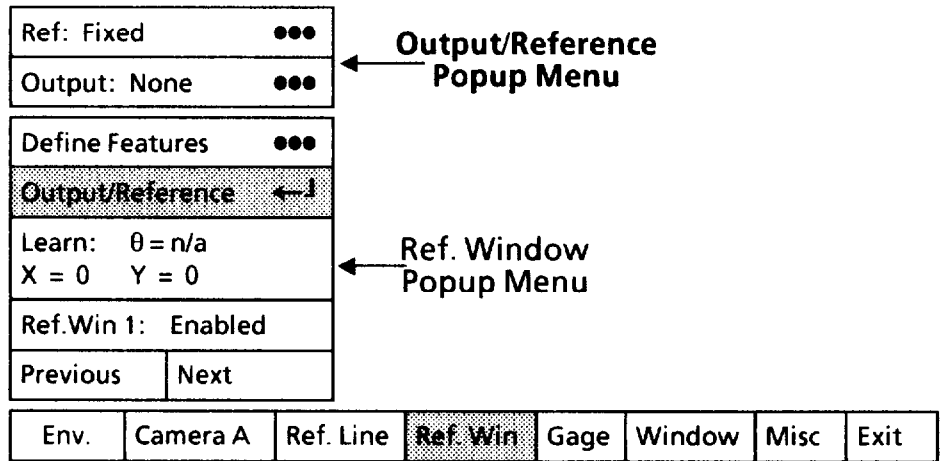

Selecting Output Line Selection Popup Menu

Select the Output Line Selection popup menu, if appropriate, then assign an output line to carry reference line "results" signals to your production equipment.

Your Action

Comments

Look at the Output menu box in the Output/Reference popup menu.

The Output menu box shows the currently selected output line assigned to *this* reference window.

**Selecting Output/Reference
Popup Menu and
Parameters (continued)**

Selecting Output Line Selection Popup Menu (continued)

Your Action

Comments

*Pick the Output menu box
in the Output/Reference
popup menu.*

When you pick the Output menu box, the Output Line Selection popup menu appears, as follows:

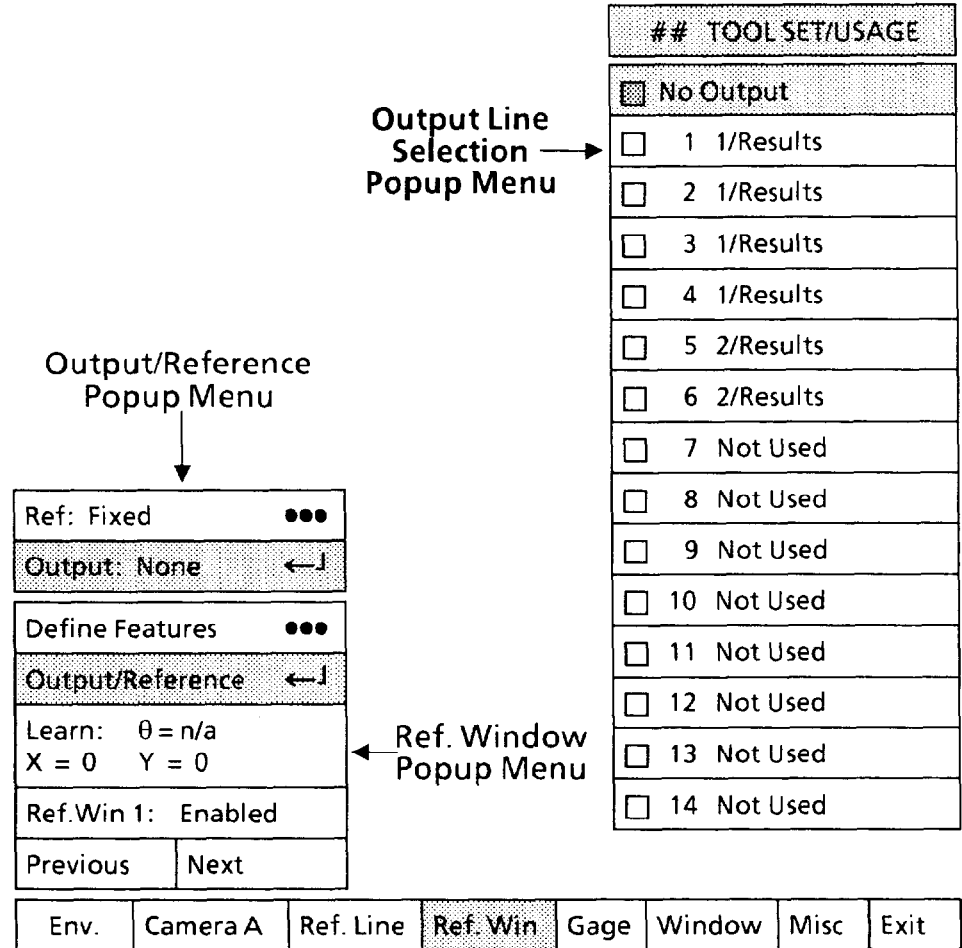

Note that the No Output box in the Output Line Selection menu has a shaded square (☐). This indicates that *no* output line is currently assigned to this reference window. Also note that you can pick *only* those output lines with a “Results” function shown in *light* type. All others are shown in **black** type, which indicates that you cannot pick them.

*Pick the appropriate output
line from the menu.*

If appropriate, pick one of the available output lines from the Output Line Selection menu.

**Selecting Output/Reference
Popup Menu and
Parameters (continued)**

Selecting Reference Popup Menu

Select the Reference popup menu, if appropriate, then assign a reference tool to provide shift compensation to *this* reference window.

You can configure *one* reference window to receive shift compensation from *another* reference line or window, with the following restrictions:

- Reference window #1 can receive shift compensation only from a reference line.
- Reference window #2 can receive shift compensation from a reference line, or shift *and* rotation compensation from reference window #1 *only*.
- Reference window #3 can receive shift compensation from a reference line, or shift *and* rotation compensation from reference window #1 or #2.

Use the following steps to select a *reference* line for the currently selected reference line.

Your Action

Comments

Look at the Ref menu box in the Output/Reference popup menu.

The Ref menu box shows the currently selected reference tool assigned to *this* reference line.

Pick the Ref menu box in the Output/Reference menu.

When you pick the Ref menu box, the Reference popup menu appears, as follows:

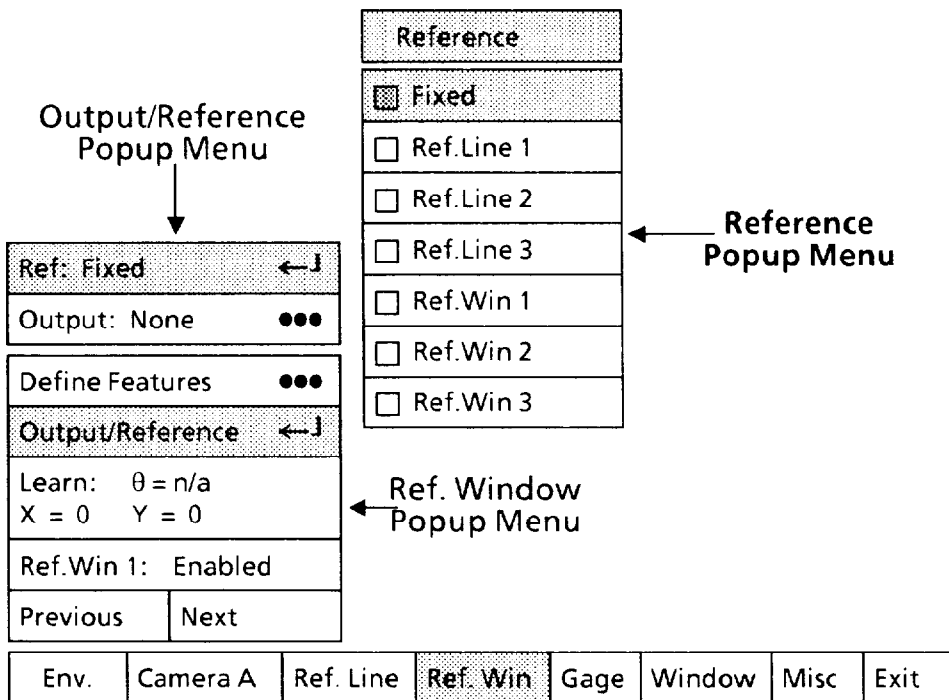

**Selecting Output/Reference
Popup Menu and
Parameters (continued)****Selecting Reference Popup Menu (continued)****Your Action****Comments**

*Pick the appropriate reference
tool from the menu.*

Note that the Fixed box in the Reference menu has a shaded square (☐). This indicates that a reference tool is not currently assigned to *this* reference window. Also note that only the *available* reference tools are in *light* type. All others are shown in **black** type, which indicates that you cannot pick them.

If appropriate, pick one of the available reference tools from the Reference menu.

Chapter 7 Inspection Tools: Gages

Chapter Objectives

The objectives of this chapter are to explain gages and show you how they can be used, and then show you the procedures for configuring them. The chapter begins with a series of questions and answers about gages.

A Few Questions and Answers About Gages

This section introduces you to gages by asking a few questions about them that might occur to you, and answering those questions.

What is a gage?

A gage is a one-dimensional image-analysis tool that inspects only the specific part of the workpiece image that it crosses.

What do these gages actually look for?

Gages look for edges. An edge is a point on a gage where a specified change occurs in the color of the pixels that make up the image of the workpiece.

How does a gage look for edges?

A gage searches along its length for specific edges on a workpiece. It begins at either end of the gage and proceeds to the other end, evaluating each pixel along the way.

How does a gage detect an edge?

It detects an edge when it sees a specified change in the color of the pixels: from black to white, from white to black, or from one specified shade of gray to another.

What kind of information can a gage get from edges?

By finding just *one* edge, a gage can calculate position information – it can tell where an edge is on a workpiece.

By finding two or more edges, it can measure distances between the edges. Or, it can simply count pixels between the edges, or just count the edges themselves.

What shapes can a gage have?

A gage has one of two shapes: straight (a *linear* gage), or circular (a *circular* gage).

What are the size, position, and angle limits of these two gage shapes?

A linear gage can be any length and can be positioned at any angular orientation anywhere within the *usable* portion of the monitor screen.

A circular gage can be either a complete circle or a portion of a circle (an arc), of any radius, and can be positioned anywhere within the *usable* portion of the monitor screen.

(Note that the usable portion of the monitor screen will be *reduced* when the light probe status is set to “same field.”)

A Few Questions and Answers About Gages (continued)

How many gages are there?

The CVIM system provides 32 gages for each of the two tool sets, for a total of 64. Each gage can be either linear or circular.

What functions can a gage perform?

A gage's function during each CVIM inspection cycle is *one* of these:

- Counting pixels, objects or edges.
- Measuring distances using a linear gage.
- Measuring distances and angles using a circular gage.

Gages

This section provides you with the details of using and configuring both linear and circular gages.

Under the *Using Linear Gages* heading, you will see simple example applications in which the CVIM system uses a linear gage to find the level of a liquid in a bottle.

Under the *Using Circular Gages* heading, you will see example applications in which the CVIM system uses circular gages to count and measure the teeth on a gear.

Under the *Configuring Gages* heading, you will find out how to use the "user interface" – the light pen and the popup menus on the video monitor screen– to configure a gage.

Using Linear Gages

The following pages describe how you can use linear gages to detect and measure parts of a workpiece.

Linear gages can be set to any length within the camera's field of view, and can be rotated to any angle.

In the following examples of using a linear gage to find the level of a liquid in a glass bottle, here are the assumptions:

- The "workpiece" is a clear glass bottle filled with an opaque liquid, such as hand lotion.
- The bottle is backlit.
- A vertically-positioned linear gage will be used to measure the liquid level.
- Shift compensation will *not* be used. (For information on shift compensation, see Chapter 6, *Reference Tools: Lines and Windows*.)

The overall objective in these examples is for the CVIM system to inspect every bottle for a correct fill level, and to reject all bottles that are not correctly filled.

Using Linear Gages
(continued)

Example 1: Figure 7.1 shows how an image of a correctly filled bottle might look on the screen of your video monitor.

Figure 7.1 Linear Gage Configured to Measure Head-to-Edge

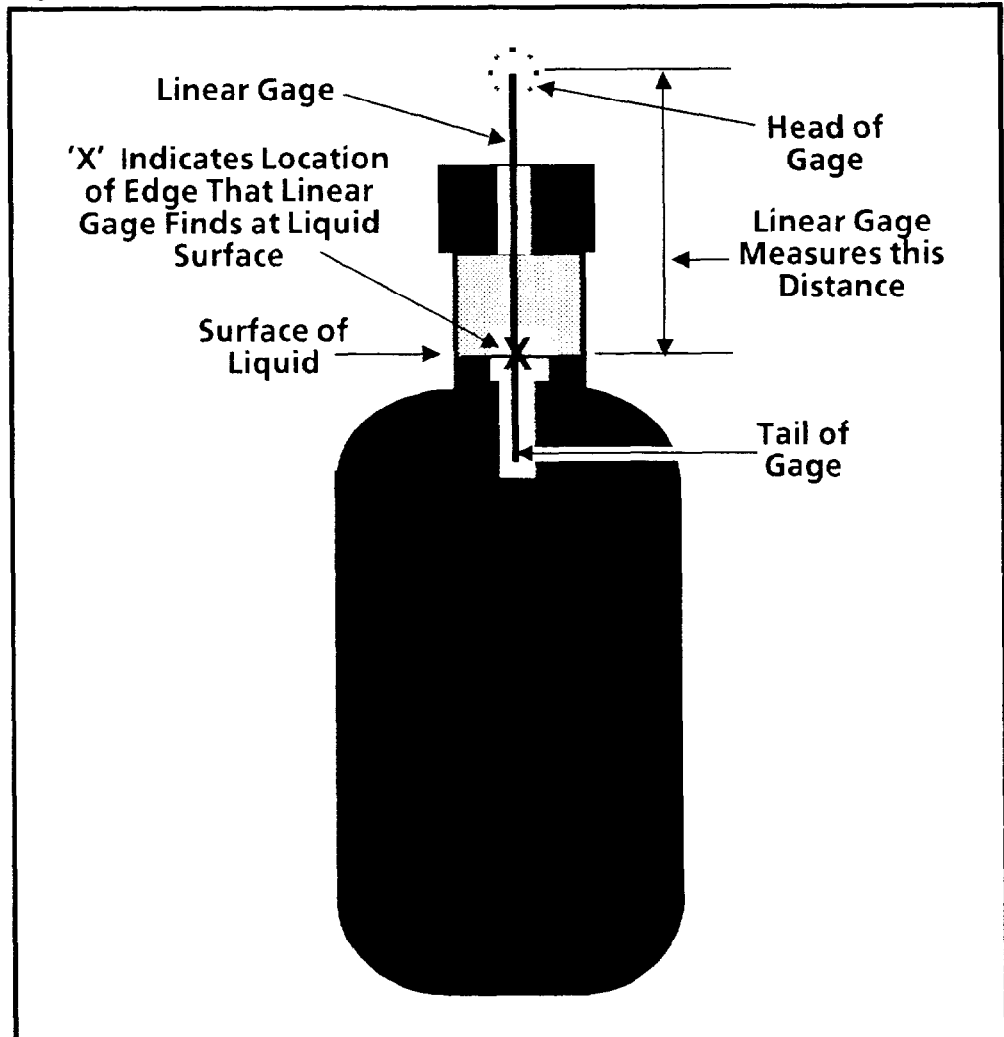

Since both the liquid and the bottle cap are opaque, they appear black when lighted from behind. Under the same backlighting conditions, the neck (above the liquid level) is likely to appear as a light shade of gray.

Figure 7.1 shows also how a linear gage might appear when it is positioned vertically over the bottle's neck. In this example, the gage needs to be just long enough to detect the liquid surface within previously set range limits.

The function of the linear gage in this example is to find the single edge that represents the surface of the liquid in the bottle, then calculate the distance from its "head" to that edge.

When the gage finds that edge, it determines whether or not the *distance* to that edge (that is, the liquid level) is within the previously set range limits. If so, the inspection "passes"; if not, the inspection "fails."

Using Linear Gages
(continued)

NOTE: Using the linear gage this way requires that each bottle be in a *fixed* position along the vertical axis, since the gage cannot differentiate between vertical variations in the bottle's position and variations in the liquid level.

Example 2: Another way to measure the liquid level is to configure the linear gage to find the distance between *two* edges: the top of the cap (fixed), and the liquid surface (variable). This is shown in Figure 7.2.

Figure 7.2 Linear Gage Configured to Measure Edge-to-Edge Distance

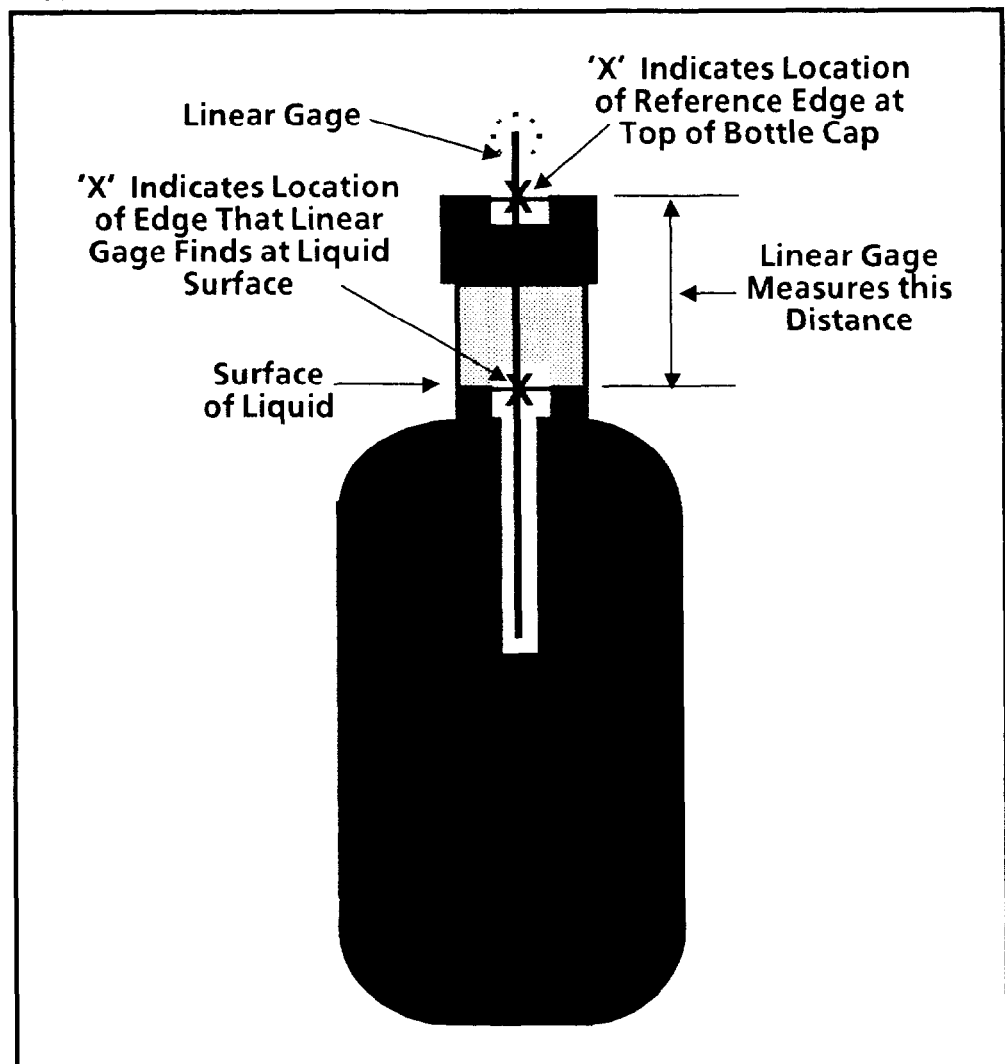

In this example, the gage should be long enough to measure the liquid level from the cap *and* to accommodate a certain amount of up-and-down bottle shift. Unlike Example 1, the range limits in this example apply only to the *distance* between the two edges; that is, their *relative* positions along the gage, *not* their *absolute* positions.

When the gage finds the two edges, it determines whether or not the distance between them (that is, the liquid level) is within the previously set range limits. If so, the inspection "passes; if not, the inspection "fails."

Using Linear Gages
(continued)

If a particular bottle shifts *down*, as shown in Figure 7.3, but the cap and liquid surface (the two edges) still lie somewhere along the gage, the gage will find the two edges, and the distance between the edges will then be calculated. (The same would be true if the bottle shifted *up*, so long as the cap and liquid surface still lie *somewhere* along the gage.)

If, however, one of the two edges lies *beyond* either end of the gage, an *inspection failure will occur*, since the distance calculation cannot be made.

Figure 7.3 Linear Gage Measuring Liquid Level on Shifted Bottle

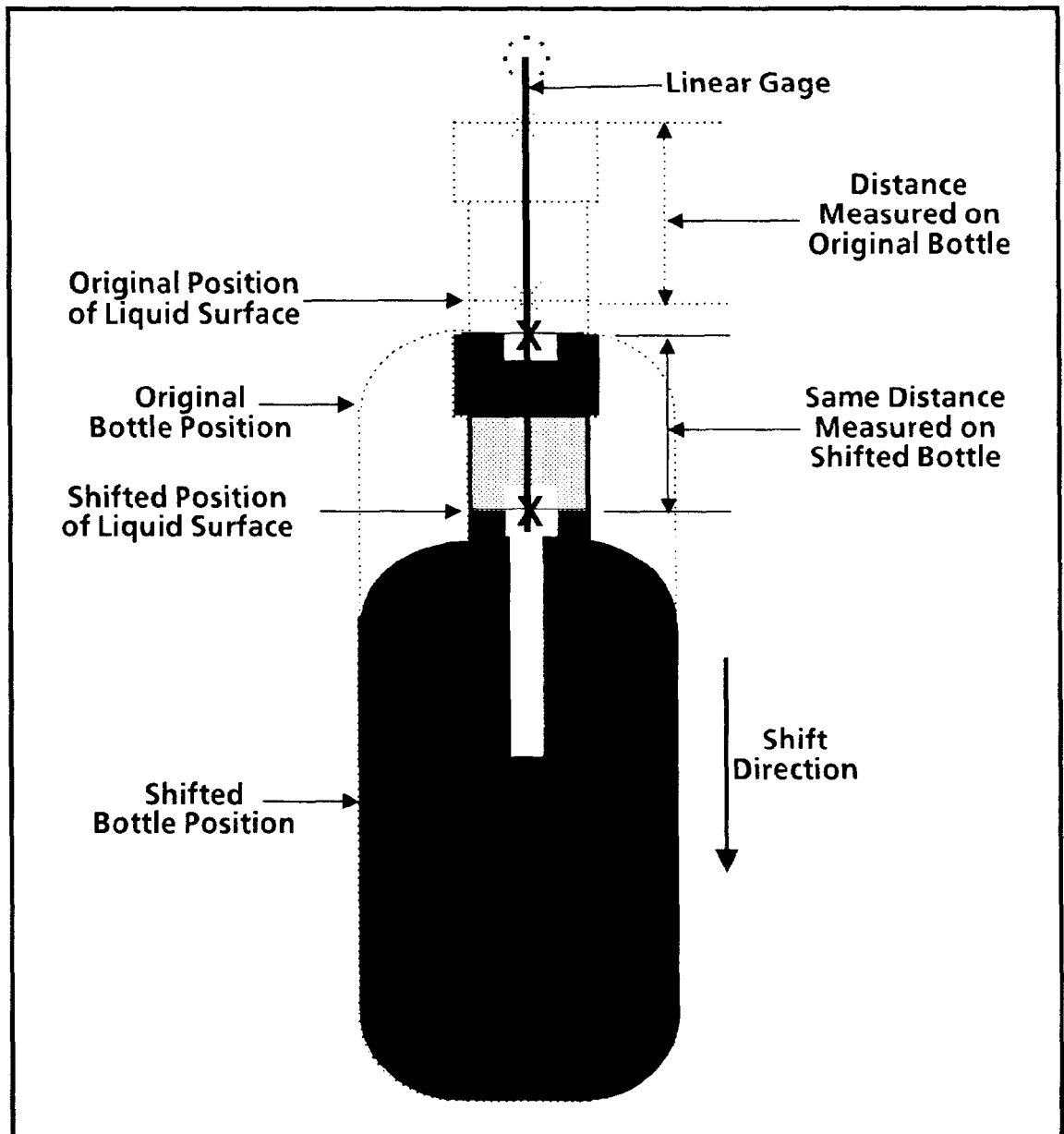

Using Circular Gages

The following pages describe how you can use circular gages to detect and measure parts of a workpiece that are arranged in an arc or circle.

Circular gages can be set to any radius or to any number of degrees of arc up to 360°, so long as they remain within the screen image.

In the following examples of using a circular gage to find the number of teeth on a gear, here are the assumptions:

- The “workpiece” is a metal gear.
- The gear is backlighted.
- A circular gage, arranged in a full circle, will be used to count the teeth.
- Shift compensation will *not* be used. (For information about shift compensation, see Chapter 6, *Reference Tools: Lines and Windows*.)

The overall objective in these examples is for the CVIM system to inspect every gear for the correct number of teeth, and to reject all gears that have broken or missing teeth.

Example 1: Figure 7.4 shows how an image of a gear might look on your video monitor. Since the gear is opaque, it will appear black when lighted from behind.

Figure 7.4 shows also how a circular gage might appear when it is centered over the gear. In this example, the gage needs to be just large enough to cross all 16 teeth at a point where it can easily detect the two edges on each tooth.

The function of the circular gage in this example is simply to find the 32 edges that represent the 16 teeth. Note that the gear in Figure 7.4 would *fail* the inspection, since one of the teeth is missing, and material between two other teeth was not removed.

When the gage finds the edges, the CVIM system determines whether or not the *number* of edges (the number of teeth times two) is correct. If the number is 32, the inspection “passes”; if not, the inspection “fails.”

NOTE: The circular gage in this example requires that each gear be in the same position during inspection. If the workpiece shifts more than the slightest amount, the result could be a failed inspection. (In a real application, if you expect workpiece shift, you will probably need the shift compensation provided by one of the reference tools. See Chapter 6, *Reference Tools: Lines and Windows*.)

Using Circular Gages
(continued)

Figure 7.4 Circular Gage Configured to Count Edges or Pixels

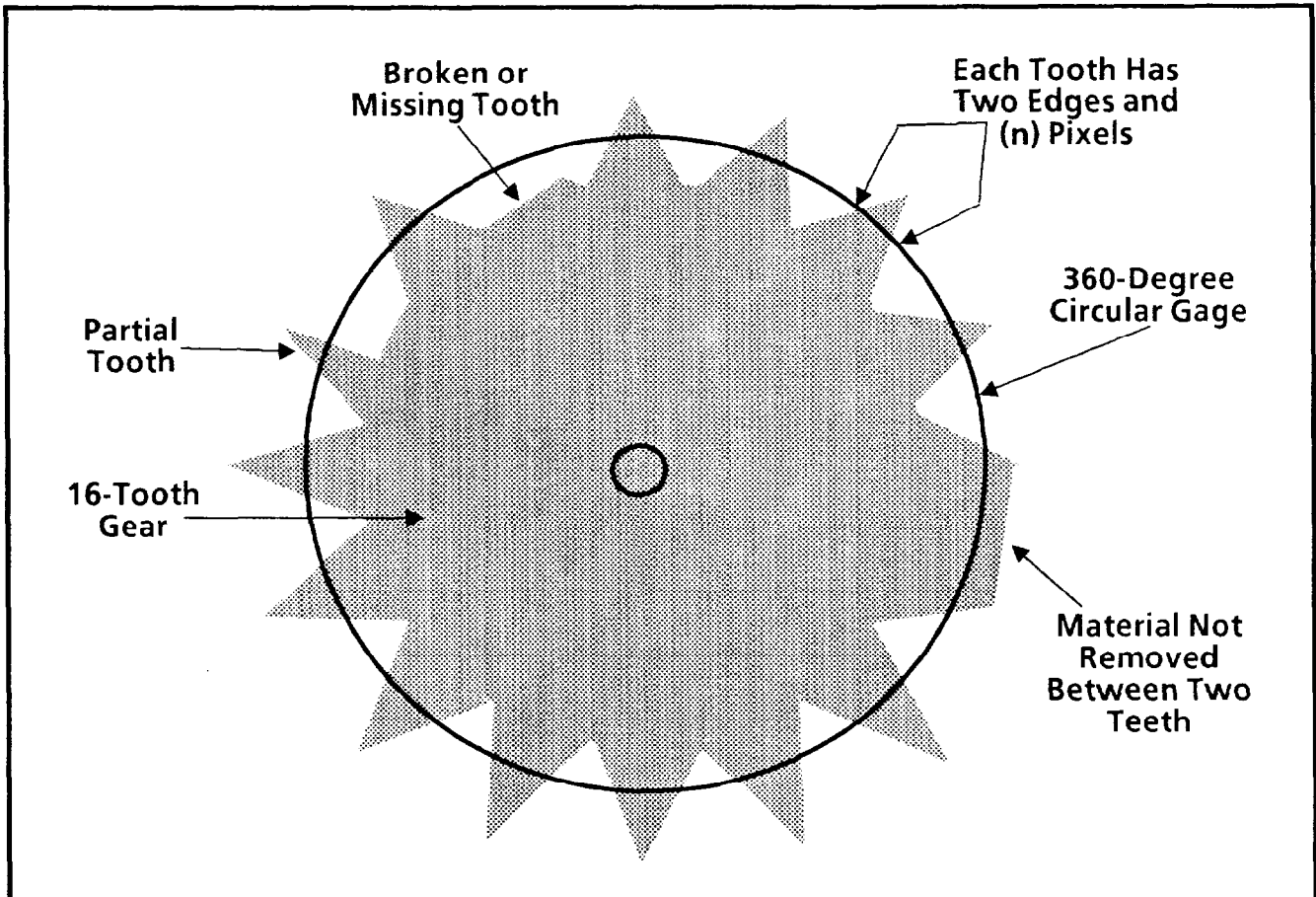

Example 2: Another way to check for all 16 teeth is to have a circular gage count the black pixels (which come from the teeth) along its circumference. The idea here is that if all 16 teeth are present, the circular gage will detect a specific number of black pixels, plus or minus some small tolerance.

In this example, if a tooth is missing, the black pixel count would be *below* the previously set lower range limit. If material were present between two teeth, the black pixel count would be *above* the upper range limit. In either case, the inspection would *fail*.

Note that if a tooth is missing *and* material is present between two teeth, as shown in Figure 7.4, the inspection *may pass*, especially if the range limits are too "loose." Thus, using a circular gage this way should probably be limited to a situation in which only one or the other condition is likely to occur.

Using Circular Gages (continued)

Example 3: In this inspection example, a series of circular gages will measure the *width* of *each tooth*. This inspection will detect any gears with flaws that may pass the inspection in Example 1 or 2.

In this example, you would configure 16 circular gages, one for each tooth. Figure 7.5 shows five of these gages.

Note that circular gage #1 would find *no* edges. Gages #2 and #3 would each find only *one* edge. Gage #4 would find two edges, but the width would be *below* the lower range limit. The teeth would *fail* the inspections of all of these gages.

Only the gage #5, the one over the normal tooth, would find two edges *and* a normal width. To pass inspection of this gage, the tooth width would have to be *between* the upper and lower range limits.

Figure 7.5 Circular Gages Configured to Measure Width of a Tooth

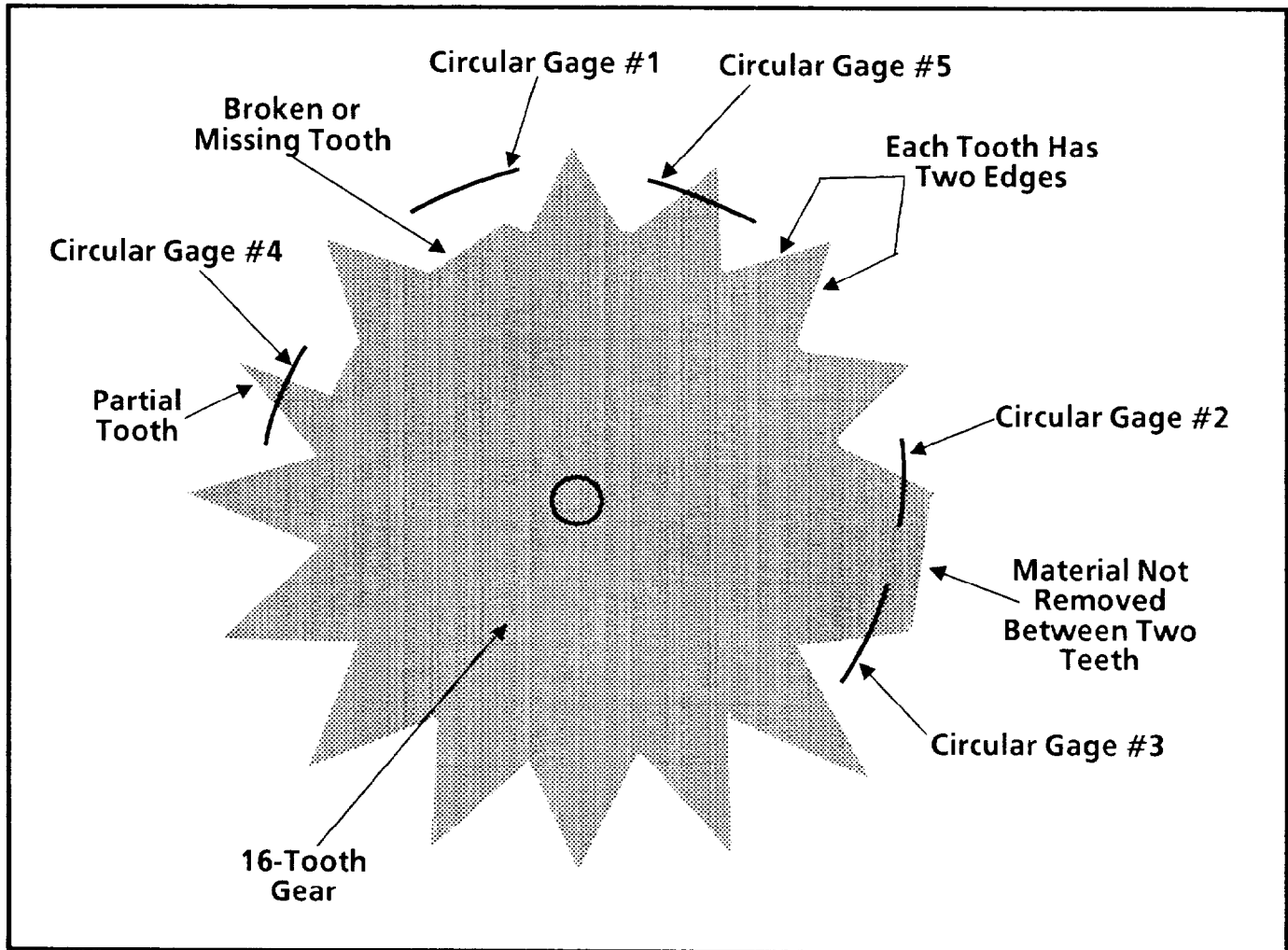

Configuring Gages

In configuring gages you will pick the configuration categories in the **Gage** popup menu, which appears when you pick **Gage** from the **Main Configuration** menu.

These are the main function and configuration categories in the **Gage** popup menu:

- **Gage definition:** Sets the gage position and length; selects the gage shape, operation, and gaging mode (binary or gray scale); and defines all edges.
- **Gage features:** Selects the *specific* edges ("features") to be used for each gage.
- **Select range limits, output lines, reference tool:** Selects the operating range limits that determine a "pass" or "fail" result; selects the output line for reporting inspection results; selects a reference tool from which to receive shift compensation.
- **Learn gage measurements:** This function "learns" the distance between edges, the number of edges, the number of pixels, or the number of objects, whichever gage *operation* you have selected.
- **Select gage number:** This function selects the gage number (1 to 32).
- **Enable/disable gage:** This function enables or disables the currently selected gage.

Configuring a gage involves these basic steps:

- Selecting the gage number (1 to 32).
- Enabling the selected gage.
- Selecting the gage shape: linear, or circular.
- Selecting either a binary or gray scale image in which to search for edges.
- Selecting the gage operation: count black pixels, count edges, make linear measurement, and so on.
- Positioning and sizing the gage(s) over the workpiece image, and identifying the edges.

The following pages show you how to perform all of the steps that configure gages. To save time, you should perform these steps in the order given.

Selecting Gage Popup Menu

Your first step is to select the Gage popup menu.

Your Action**Comments**

Pick Gage in the Main Configuration menu.

When you pick the Gage menu box, the Gage popup menu appears above the Main Configuration menu, as follows:

Define Gage		●●●
Define Features		●●●
Range/Reference		●●●
Learn: Nominal =		← Gage Popup Menu
0.000 Pixels		
Gage 1: Enabled		
Previous	Next	

Env.	Camera A	Ref. Line	Ref. Win	Gage	Window	Misc	Exit
------	----------	-----------	----------	------	--------	------	------

The Gage popup menu shows the six configuration categories described earlier.

In addition to the Gage popup menu, if the currently selected gage is *enabled*, as shown above, it will appear somewhere on the monitor screen.

Selecting and Enabling Gage

Select the gage number and enable the gage.

Your Action**Comments**

Look at the Gage menu box in the Gage popup menu.

The Gage menu box indicates the currently selected gage number (1 to 32). It also indicates whether that gage is enabled or disabled.

Select the gage number.

To change the gage number, pick the Next (or Previous) menu box repeatedly until the correct number appears.

The Next and Previous functions work like this: When you pick the Next box, the next *higher* gage number appears: 1, 2, 3, . . . 32, 1, 2, 3, and so on. When you pick the Previous box, the next *lower* gage number appears: 3, 2, 1, 32 . . . 3, 2, 1, and so on.

Look at the Gage menu box again.

If the gage status is Disabled, perform the next step.

Pick the Gage menu box.

When you pick the Gage menu box, the status will change to Enabled. (To *disable* the gage again, pick the box again.)

**Selecting Define Gage
Popup Menu and
Parameters**

Select the Define Gage popup menu, then select the parameters in that menu.

Your Action

Pick the Define Gage menu box in the Gage popup menu.

Comments

When you pick the Define Gage menu box, the Define Gage popup menu appears above the Gage popup menu, as follows:

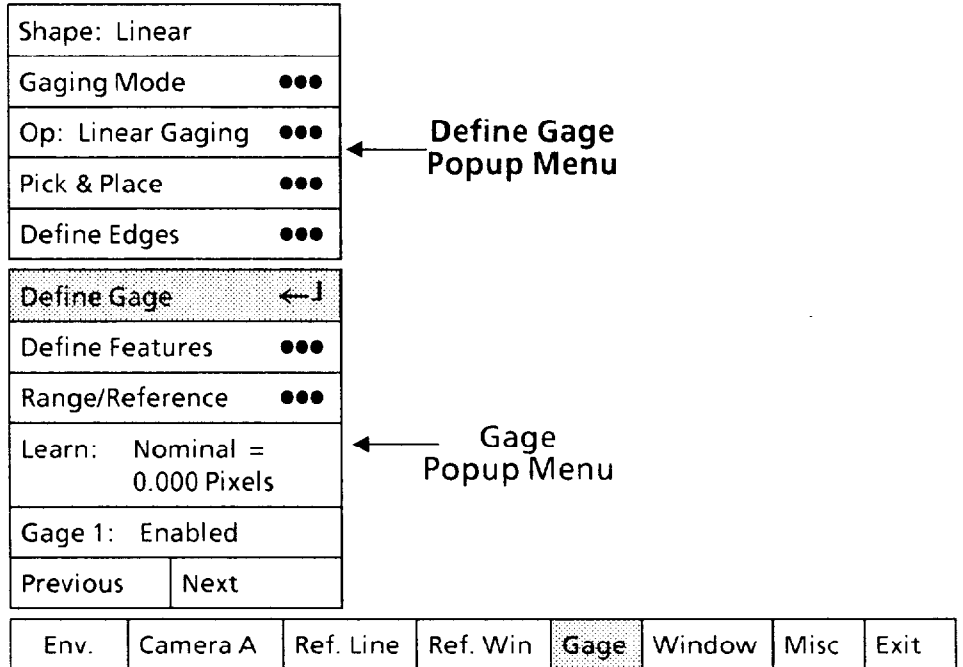

Selecting Gage Shape

Pick the Shape menu box to select either a *linear* or a *circular* gage, whichever is appropriate for your application. Your choice of gage shape depends on the *shape* of the workpiece at the point where you want the gage to inspect it.

Your Action

Look at the Shape menu box in the Define Gage popup menu.

Pick the Shape menu box, if appropriate, to select Linear or Circular.

Comments

The Shape menu box shows whether the currently selected gage is Linear or Circular. If the shape indicated is the one you want, skip the next step.

If necessary, pick the Shape menu box to toggle to the *other* gage shape. A gage of the selected shape will appear somewhere on the monitor screen. (To change back to the previous shape, pick the box again.)

Selecting Define Gage Popup Menu and Parameters (continued)

Selecting Operation *Popup Menu*

Select the Op menu box, then select one of eight operations for a *linear* gage, or ten operations for a *circular* gage, as follows:

1. Count the number of *white pixels* along the length of the gage.
2. Count the number of *black pixels* along the length of the gage.
3. Count the number of *white objects* along the length of the gage.
4. Count the number of *black objects* along the length of the gage.
5. Count the number of *edges* along the length of the gage.
6. Measure the *linear* distance between two specific edges ("features") on a linear or circular gage. Measurements are stated in inches, centimeters, or pixels, according to how you configured the Units menu in Chapter 4, *Operating Environment* (under Env. in the Main Configuration menu).
7. Report the *X coordinate location* of the active feature. The location is stated in pixels, inches, or centimeters, according to how you configured the Units menu in Chapter 4, *Operating Environment* (under Env. in the Main Configuration menu).
8. Report the *Y coordinate location* of the active feature. The location is stated in pixels, inches, or centimeters, according to how you configured the Units menu in Chapter 4, *Operating Environment* (under Env. in the Main Configuration menu).
9. Measure the *angle* between the implied center of a circular gage and two specific edges on the gage.
10. Measure the *angle* between a line drawn through two specific edges on a circular gage and the X axis of the screen image.

Your choice of gage operation depends on whichever gage operation is appropriate for your application.

NOTE: The first four operations are not available when the gaging mode is set to Gray Scale. The last two operations are not available when the gage shape is set to Linear.

Your Action

Look at the Op menu box in the Define Gage popup menu.

Comments

The Op menu box indicates the currently selected gage operation. If this is the gage operation you want, skip gage operation selection and continue instead with gaging mode selection.

**Selecting Define Gage
Popup Menu and
Parameters (continued)**

Selecting Operation Popup Menu (continued)

Your Action	Comments
<i>Pick the Op menu box.</i>	When you pick the Op menu box, the Operation popup menu will appear, as follows:

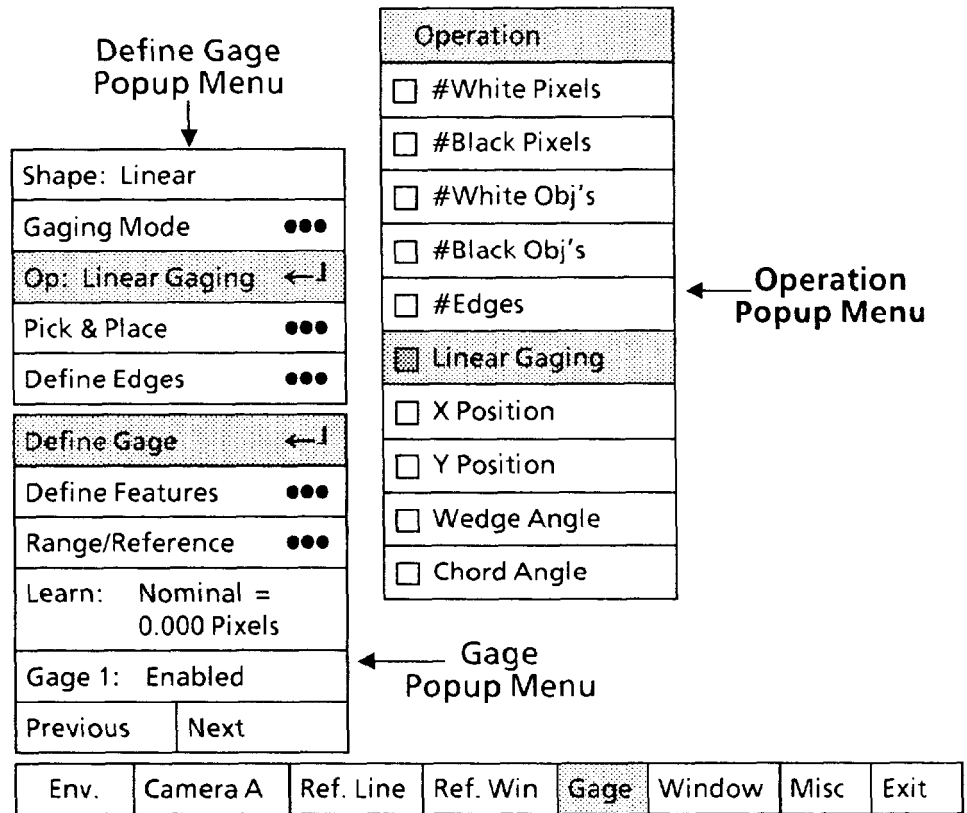

Note that the Linear Gaging box in the Operation popup menu has a shaded square (☑). This indicates that Linear Gaging is the currently selected gage operation.

Pick the appropriate gage operation from the Operation popup menu.

If you pick a *different* gage operation menu box, a message will appear above the Operation menu, as follows:

WARNING: Selecting a new tool operation will result in the nominal, range, and statistical values being set to zero. Reselect to confirm.

This message asks you to verify that you really want to change the tool operation. If so, pick the same gage operation menu box *again*.

Pick the same gage operation menu box again.

When you pick the same menu box again, the new selection will be highlighted in the Operation popup menu and will appear in the Op menu box.

Selecting Define Gage Popup Menu and Parameters (continued)

Selecting Gaging Mode *Popup Menus*

Select the Gaging Mode menu box, then select the gaging mode (Binary or Gray Scale).

NOTE: Selecting Gray Scale *enables* selecting the sub pixel functions; selecting Binary *disables* selecting the sub pixel functions.

The Binary gaging mode changes pixels in the screen image to two states, white and black. The only pixels changed are those that directly surround the gage in a box called the "area of interest." The CVIM system examines only these pixels when processing a gage

The binary gaging mode is most appropriate when the workpiece has a sharp black-and-white contrast with its background, such as when it is backlighted. This mode is also appropriate when maximum precision is not needed for linear measurements.

The Gray Scale gaging mode does not affect the pixels surrounding the gage – they remain in their original state, in which they can have any one of 64 shades of gray.

The gray scale gaging mode is most appropriate when the workpiece has less contrast with its background, such as when it is frontlighted. This gaging mode is appropriate because features on the workpiece may appear in the screen image as varying shades of gray, and the binary gaging mode may not enable you to identify a *stable* edge location on these features.

The gray scale gaging mode is also appropriate when you need greater precision in linear measurements, especially when used with the Sub Pixel function.

As noted earlier, the Sub Pixel function is available *only* with the gray scale gaging mode. It enables a gage to detect an edge when that edge does *not* lie on a pixel boundary. The sub pixel function *interpolates* gray scale values along the edge to find a more *accurate* location for that edge *within* a pixel.

Two advantages of using the sub pixel function are:

1. The gage measurement is more *accurate*, since the accuracy is no longer limited by the size of a pixel.
2. The gage measurement is more *repeatable*, since the edge is not likely to "dither" back and forth between two pixels.

The disadvantage is a small increase in computation time.

**Selecting Define Gage
Popup Menu and
Parameters (continued)**

Selecting Gaging Mode *Popup Menus* (continued)

The Sub Pixel function enables you to *widen* a gage from one pixel to three or five pixels. The extra width enables a gage to analyze a small “neighborhood” of pixels on each side and thereby reduce the effects of an uneven or “noisy” edge.

The function *averages* gray scale values along each side of a gage. When the gage encounters an edge, it can then find a more *accurate* location for that edge. The function is particularly useful when a gage crosses an edge at right angles and the edge is uneven or serrated.

The disadvantage is an increase in computation time.

Use the following steps to select the gaging mode and associated functions.

Your Action

Pick the Gaging Mode menu box in the Define Gage popup menu.

Comments

When you pick the Gaging Mode menu box, two menus appear alongside the first two popup menus, as follows:

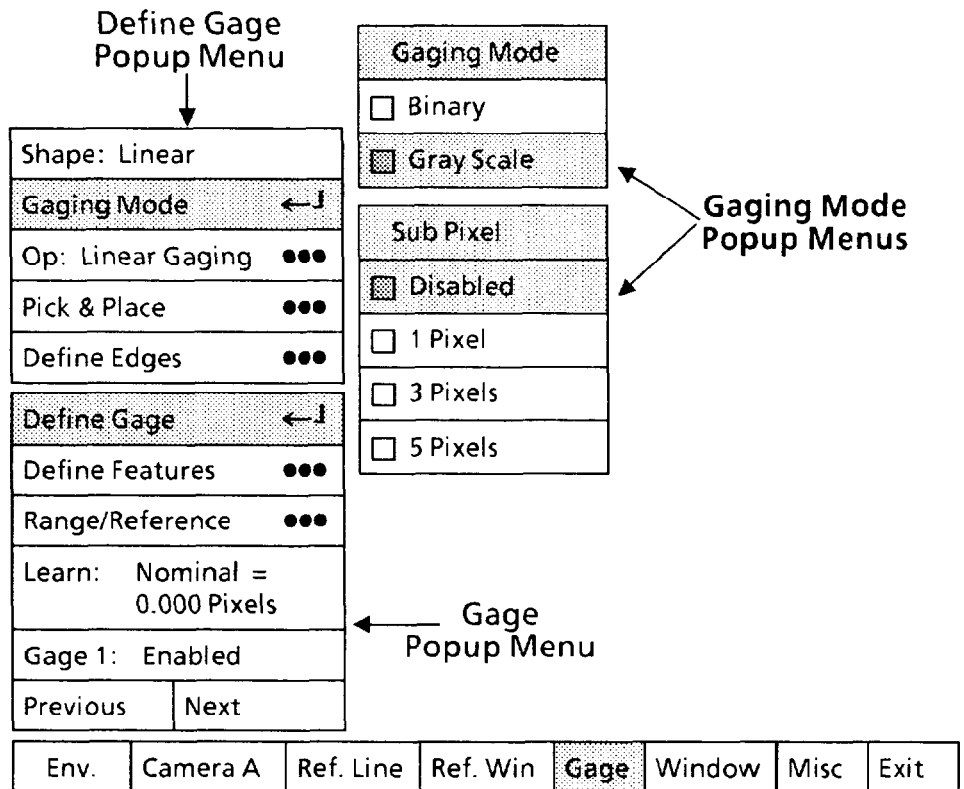

**Selecting Define Gage
Popup Menu and
Parameters (continued)**

Selecting Gaging Mode *Popup Menus* (continued)

Your Action

Comments

*Pick Binary or Gray Scale
from the Gaging Mode menu.*

Note that the Gray Scale and Disabled boxes in the gaging mode popup menus each have a shaded square (◻). This indicates the current gaging mode configuration for the currently selected gage.

Your choice of a Binary or Gray Scale gaging mode depends, in part, upon the type and direction of lighting you are using to illuminate your workpiece.

*If you picked Gray Scale,
pick 1 Pixel or Disabled
from the Sub Pixel menu.*

Your choice of 1 Pixel or Disabled depends upon whether your gage application is performing measurements and requires maximum accuracy. If so, pick 1 Pixel to enable the Sub Pixel function using a one-pixel-wide gage.

*Pick the 3 Pixels or 5 Pixels
if that is appropriate for
your application.*

If your gage application is performing measurements, and one or both edges that the gage uses is rough or serrated, pick 3 Pixels or 5 Pixels. Try 3 Pixels first. If that doesn't work well enough, pick 5 Pixels.

Using Pick & Place Function

Select the Pick & Place menu box, then position the gage over the workpiece and set the gage's size and orientation.

The following procedure has examples that show you how to use the light pen to manipulate a *linear* gage. A subsequent example shows how to manipulate a *circular* gage.

Each example includes these basic steps:

- Positioning a gage over the part of the workpiece that you want the gage to inspect.
- Setting the gage to the appropriate length, size, and orientation.

The example in the next several steps configures a *linear* gage *vertically* over a rectangular workpiece, starting with the *horizontal* linear gage below. (The same steps apply regardless of the gage's initial position.)



**Selecting Define Gage
Popup Menu and
Parameters (continued)**

Using Pick & Place Function (continued)

Use the following steps to position the linear gage and set its length.

Your Action

Comments

Pick the Pick & Place menu box in the Define Gage popup menu.

When you pick the Pick & Place line, a small square (□) will appear in the center and at each end of the gage:

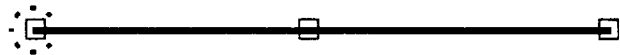

Aim the light pen at the center handle.

These squares are the “handles” that the light pen uses to manipulate the gage.

Aim the light pen at the center handle until the light pen “sees” the handle. You may have to move the light pen around slightly.

When the light pen sees the handle, a larger “highlight” square will surround the handle, as follows:



Hold the pen steady in this position – the appearance of the highlight square means that the light pen is now properly aimed at the handle.

Pick the handle.

You can now “drag” the gage across the screen. When you move the pen, the entire gage will follow.

Drag the gage to the center of the workpiece.

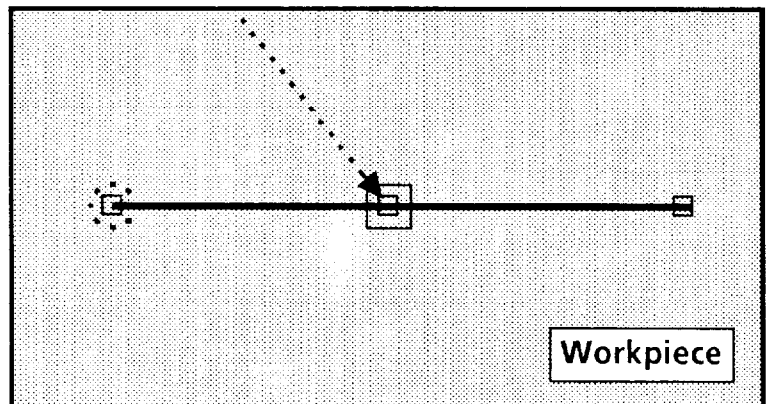

**Selecting Define Gage
Popup Menu and
Parameters (continued)**

Using Pick & Place Function (continued)

Your Action

*Aim the light pen at the
rightmost handle.*

Pick the handle.

*Drag the right end of the
gage above the workpiece.*

Comments

NOTE: Keep the tip of the pen within about one-half inch of the screen.

When you have the gage centered over the workpiece, press the pen against the screen to "lock" the gage at that position.

Continue when the highlight square appears.

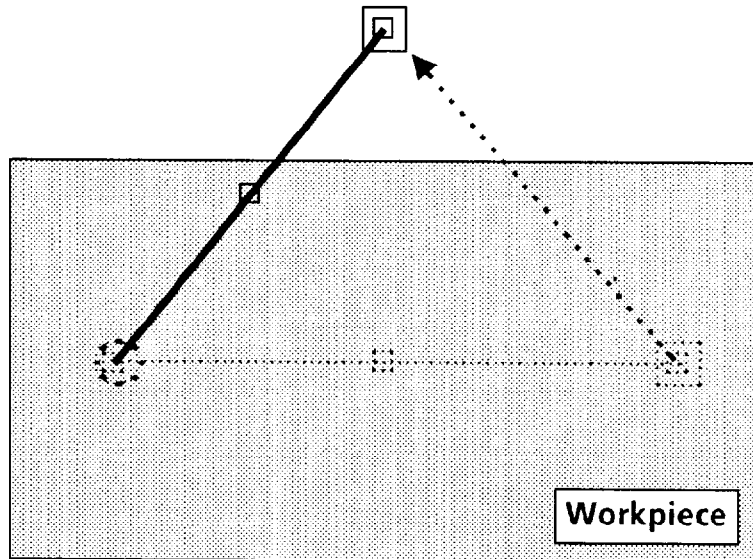

*Lock the gage end in position
above the workpiece.*

**Selecting Define Gage
Popup Menu and
Parameters (continued)****Using Pick & Place Function (continued)****Your Action**

*Aim the light pen at the
leftmost handle.*

Comments

Continue when the highlight square appears.

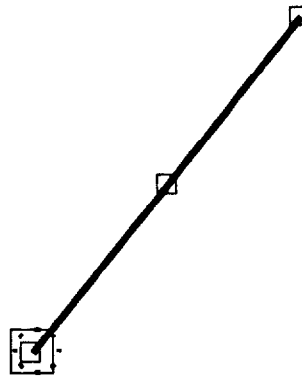

Pick the handle.

*Drag the left end of the
gage below the workpiece.*

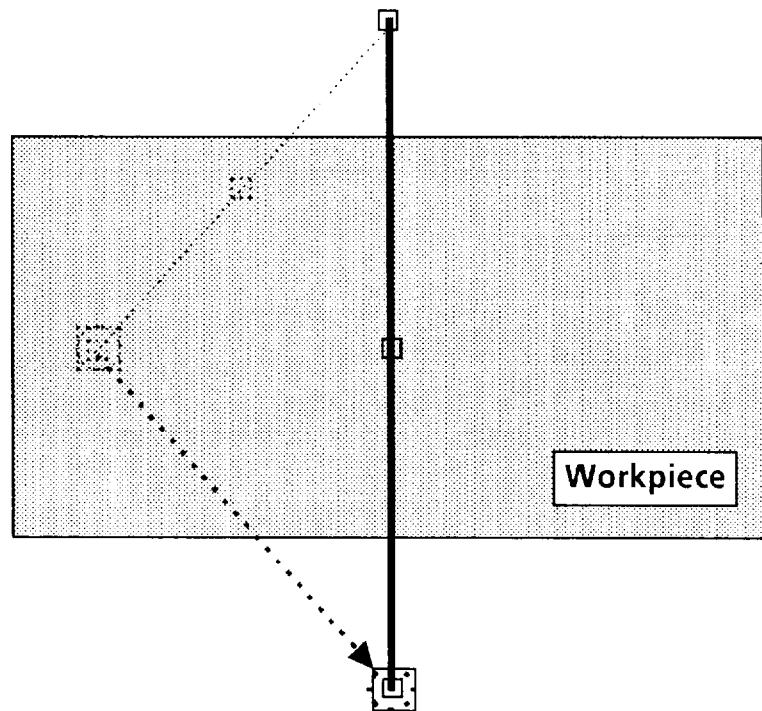

*Lock the gage end in position
below the workpiece.*

Selecting Define Gage Popup Menu and Parameters (continued)

Using Pick & Place Function (continued)

Your Action

If necessary, use the vernier arrows to "fine-tune" the position of the gage or gage end.

Press and hold the light pen tip against the gage handle, gage, or gage end.

Comments

You can position the gage or gage end more *precisely* by using the *vernier* arrows. These arrows enable you to move the gage or gage end in increments of one pixel.

You can access the vernier arrows while either *picking* a gage handle or *placing* a gage or gage end.

Hold the light pen tip in for about *one second*. The vernier arrows will then appear in the lower-right corner of the screen:

VERNIER ARROWS

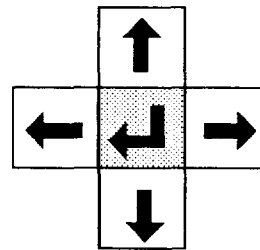

Move gage, or
gage end, up,
down, left, or
right

Pick an arrow once to move the gage or gage end one pixel in the arrow's direction.

Pick and hold an arrow to move the gage or gage end continuously.

Pick the "return" symbol to release the vernier arrows.

Pick the up, down, right, or left arrow, as appropriate, to move the gage or gage end *one pixel* in the direction indicated by the arrow.

When you pick and *hold* an arrow, the gage or gage end will move slowly for the first five or six pixels. It will then accelerate to a more rapid rate of movement.

When the gage or gage end is properly positioned, pick the "return" symbol (←┘) to *release* the vernier arrows and return to the pick-and-place mode.

At this point, you will have completed adjusting the gage's position and length so that it intersects the upper and lower edges on the workpiece.

**Selecting Define Gage
Popup Menu and
Parameters (continued)**

Using Pick & Place Function (continued)

If you selected the *circular* gage shape, you will need to know how the Pick & Place symbols are used to manipulate a circular gage. Starting with the following circular gage . . .

x



. . . note that the letter X always appears at the implied *center* of the circle, regardless of the number of degrees in the circular gage:

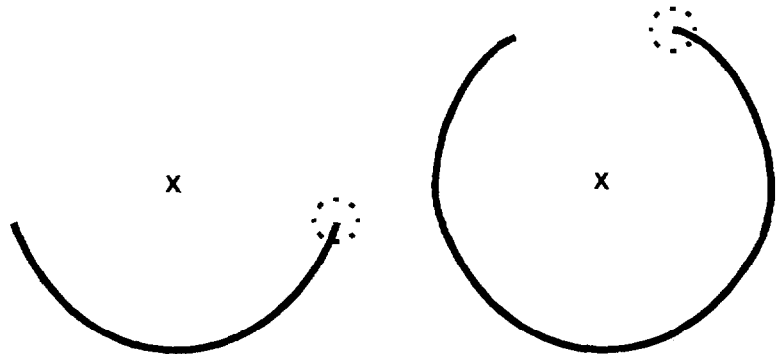

When you pick the Pick & Place menu box, "handles" (□) will appear as follows:

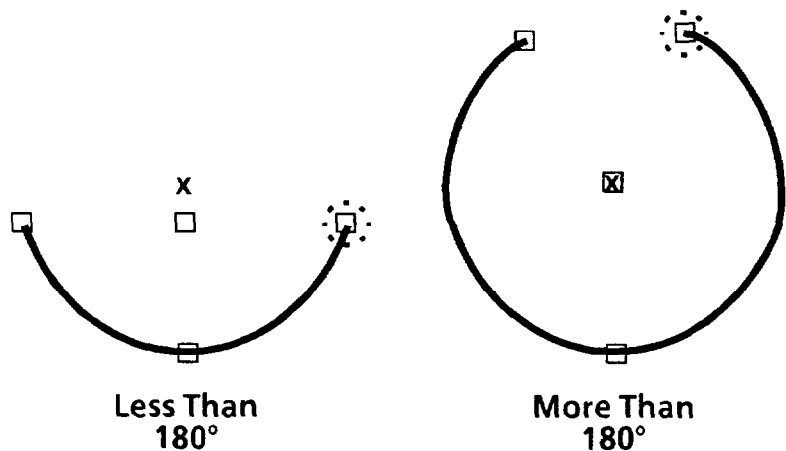

Selecting Define Gage Popup Menu and Parameters (continued)

Using Pick & Place Function (continued)

Note that there are *four* handles, as follows:

- One handle is at the *head* of the gage.
- One handle is at the *tail* of the gage.
- One handle is at the *midpoint* of the gage.
- For gages of *less than 180°*, a “center” handle is at the midpoint of a *chord* joining the head and tail.
- For gages of *more than 180°*, a “center” handle is over the X at the implied center of the gage.

When you selected Pick & Place (after selecting the circular gage shape), the Mode popup menu appeared on the screen as follows:

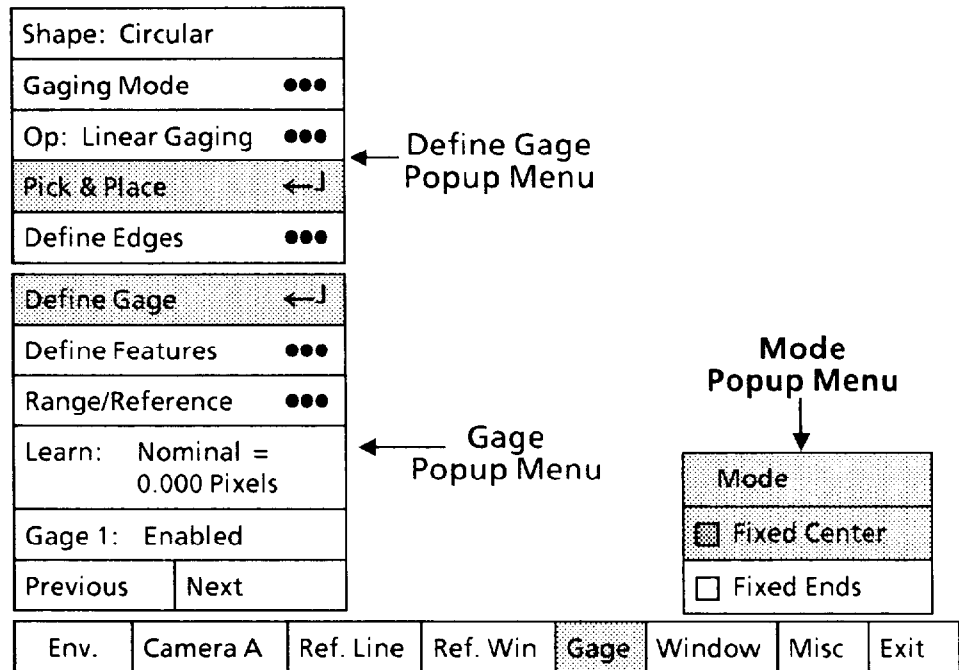

Note that the Fixed Center box in the Mode popup menu has a shaded square (). This indicates that Fixed Center is the currently selected pick-and-place mode for the *midpoint* handle.

The Mode menu determines the operation of the midpoint handle on the circular gage.

Fixed Center causes the center “X” to remain fixed when you move the midpoint handle. As you move the handle *toward* the center X, the radius of the gage *decreases*. As you move the handle *away* from the X, the radius *increases*. The number of degrees in the circular gage remains constant in both cases.

**Selecting Define Gage
Popup Menu and
Parameters (continued)**

Using Pick & Place *Function* (continued)

Fixed Ends causes the two ends of the circular gage to remain fixed when you move the midpoint handle. As you move the handle *toward* the center X, the number of degrees in the circular gage *decreases*. As you move the handle *away* from the X, the number of degrees in the circular gage *increases*.

The general procedure for moving and sizing circular gages is the same as for linear gages. The main difference is that with a circular gage, you set both the degrees of arc (up to 360 degrees) and the length of the radius.

In the following pick-and-place procedure, the "workpiece" is a speedometer. The procedure shows how you could configure a circular gage to measure the position of a speedometer pointer, starting with the following circular gage:

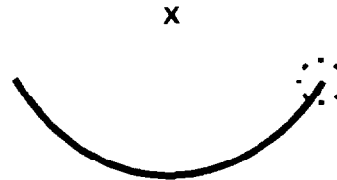

The idea is to determine whether the pointer is acceptably close to "60" while the speedometer is operating on a test fixture.

Your Action

*Pick the Fixed Center mode
for the midpoint handle.*

*Aim the light pen at the
"center" handle.*

Comments

Aim the light pen at the "center" handle until the light pen "sees" the handle. You may have to move the light pen around slightly.

When the light pen sees the handle, a larger "highlight" square will surround the handle, as follows:

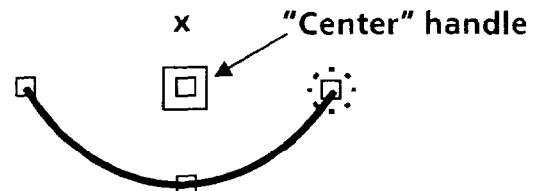

Hold the pen steady in this position – the appearance of the "highlight" square means that the light pen is now properly aimed.

**Selecting Define Gage
Popup Menu and
Parameters (continued)**

Using Pick & Place Function (continued)

Your Action

Comments

Pick the "center" handle.

You can now "drag" the entire gage around on the screen. When you move the pen, the gage follows.

Drag the gage so that the center "X" lies over the pointer pivot, as shown.

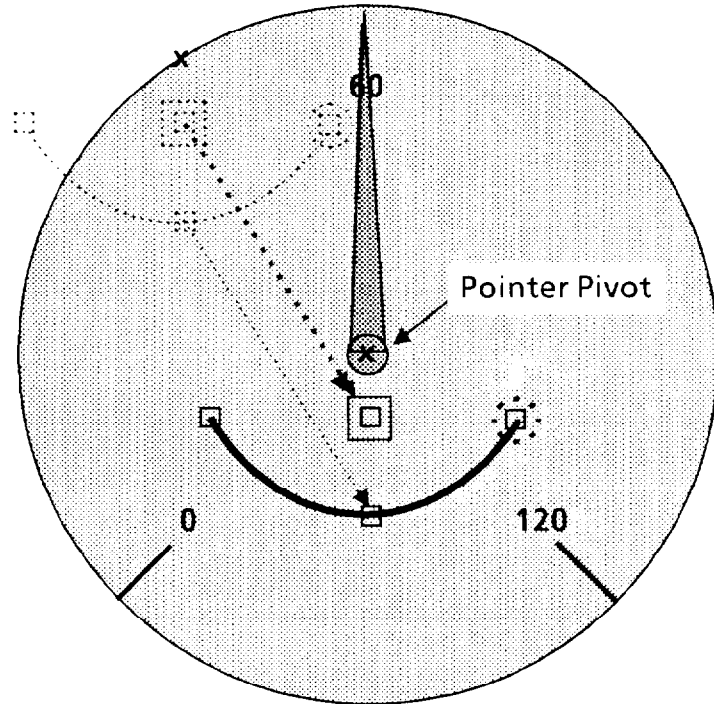

NOTE: Keep the tip of the light pen within about one-half inch of the screen.

When you have the gage in position over the workpiece, press the pen against the screen to "lock" the gage at that position.

Aim the light pen at the midpoint handle.

Continue when the highlight square appears.

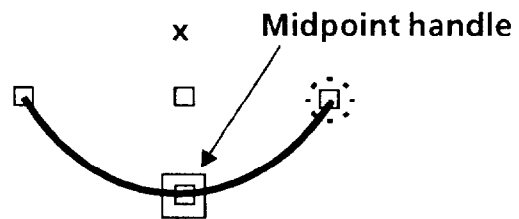

**Selecting Define Gage
Popup Menu and
Parameters (continued)**

Using Pick & Place Function (continued)

Your Action

Comments

*Drag the gage to the position
shown in the figure.*

Initially, the gage should intersect the "0" and "120" index
marks as shown in the figure.

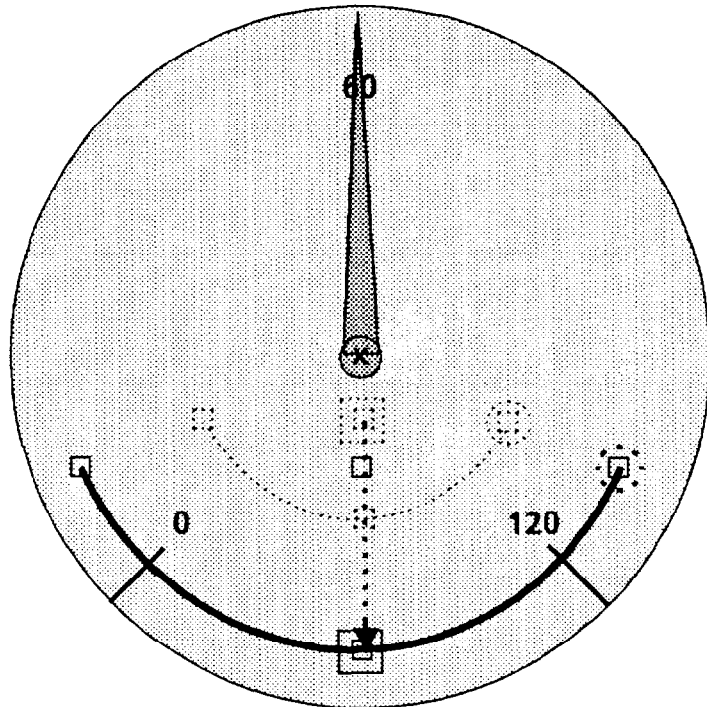

*Lock the gage in position
as shown in the figure.*

*Aim the light pen at the
leftmost handle.*

Continue when the highlight square appears.

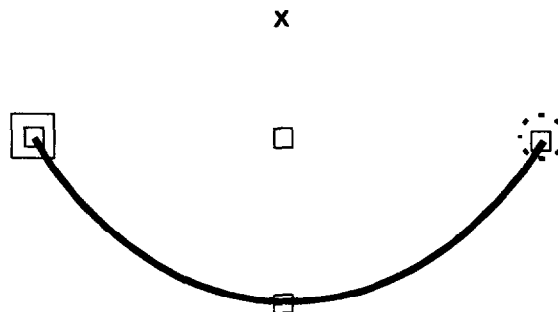

**Selecting Define Gage
Popup Menu and
Parameters (continued)**

Using Pick & Place Function (continued)

Your Action

Pick the handle.

*Drag the leftmost end of the
gage until it crosses the
pointer as shown.*

Comments

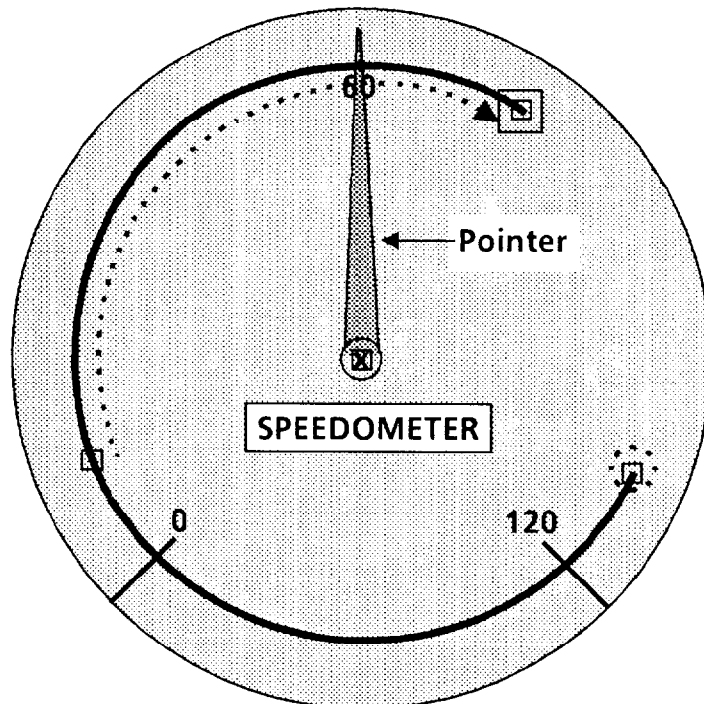

*Lock the gage end in position
as shown in the figure.*

*Aim the light pen at the
rightmost handle.*

Continue when the highlight square appears.

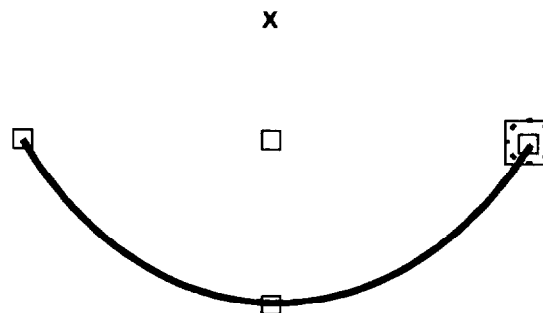

**Selecting Define Gage
Popup Menu and
Parameters (continued)**

Using Pick & Place Function (continued)

Your Action

Pick the handle.

*Drag the rightmost end of the
gage to the position shown.*

Comments

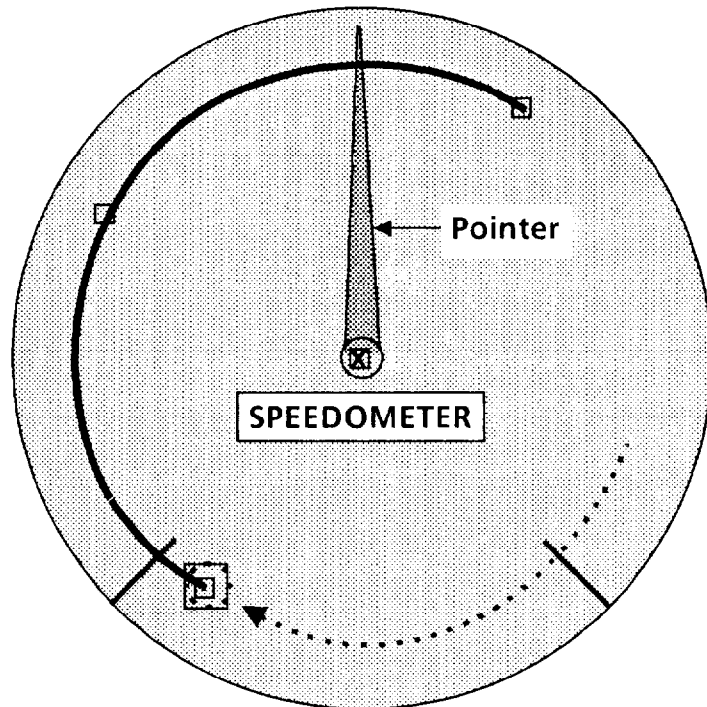

*Lock the gage end in position
as shown in the figure.*

The circular gage is now positioned to detect edges at the "0" index mark and the speedometer pointer.

The preceding steps made use of the Fixed Center mode to manipulate the midpoint handle. In this case, you expanded the radius while maintaining the center position.

Use the following steps to familiarize yourself with the midpoint handle using the Fixed Ends mode.

*Pick the Fixed Ends menu box
in the Mode menu.*

Pick the "help" icon.

The "help" icon looks like this:

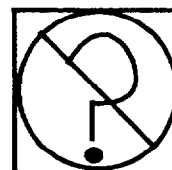

**Selecting Define Gage
Popup Menu and
Parameters (continued)**

Using Pick & Place Function (continued)

Your Action

Comments

When you pick the "help" icon, the message box will appear in the upper-left corner of the monitor screen:

Head Location:	x = 369,	y = 126
Tail Location:	x = 376,	y = 75
Origin:	x = 399,	y = 102 Radius: 49

The numbers indicate the circular gage's current position and size: the X- and Y-axis coordinates of the gage's head, tail, and center ("origin"), and the gage's *radius* in pixels (as measured along the X axis).

These numbers may be useful to you in setting the gage's radius when you use the midpoint handle.

*Aim the light pen at the
midpoint handle.*

Continue when the highlight square appears.

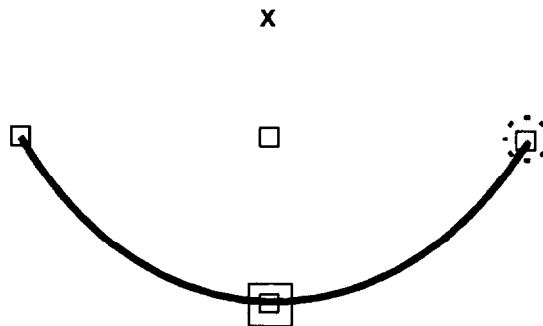

Pick the midpoint handle.

**Selecting Define Gage
Popup Menu and
Parameters (continued)**

Using Pick & Place Function (continued)

Your Action
Drag the gage's midpoint
downward, as shown.

Comments

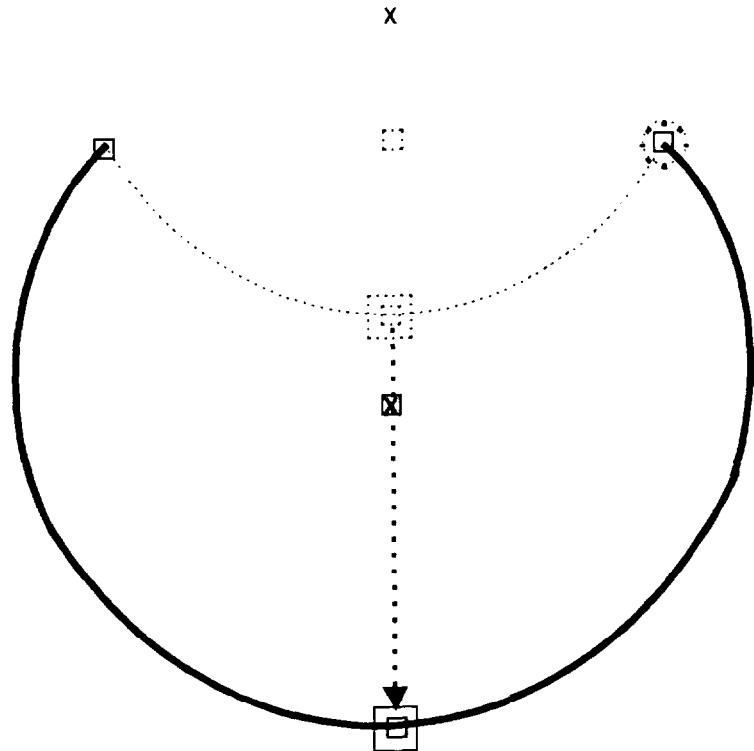

Note how the gage's position and size have changed.

Note also that the midpoint handle can move *only* in a direction that is *perpendicular* to a line drawn through the two gage ends, as shown below. This is true regardless of the orientation of the ends.

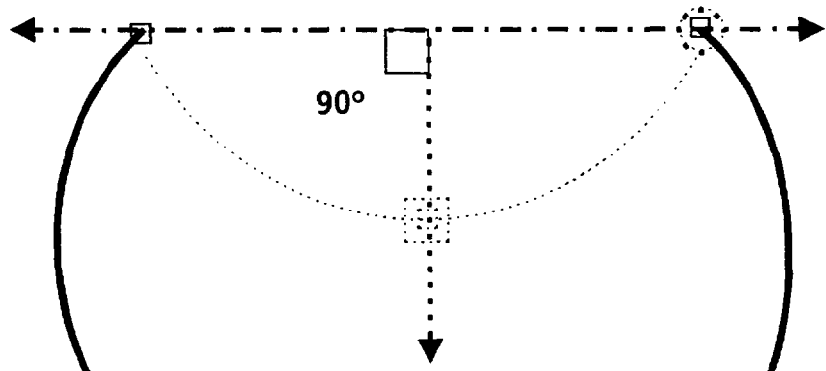

**Selecting Define Gage
Popup Menu and
Parameters (continued)**

Using Pick & Place Function (continued)

Your Action

*Drag the gage's midpoint
upward as shown.*

Comments

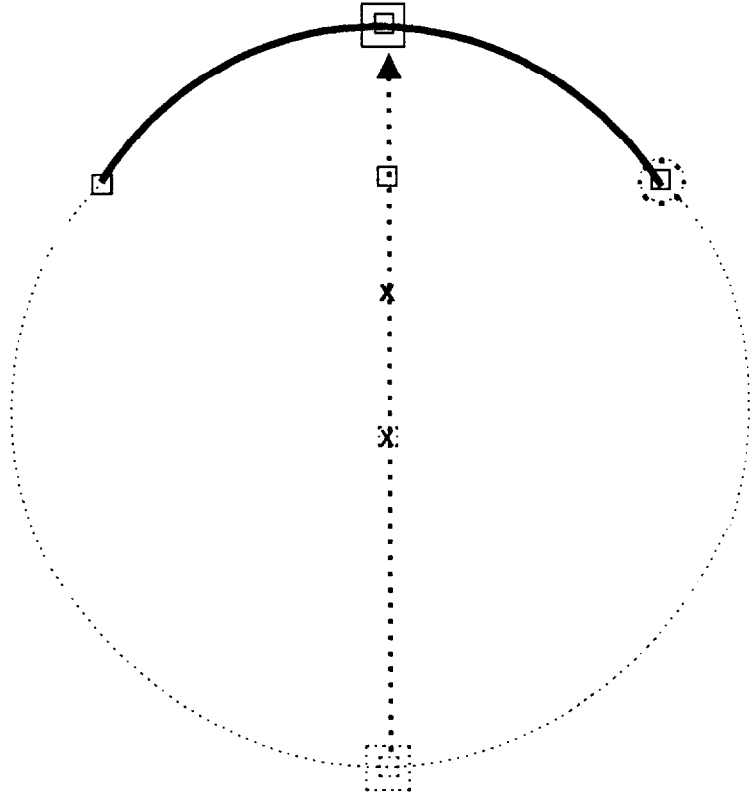

*When you are finished,
lock the gage in place.*

Selecting Define Gage Popup Menu and Parameters (continued)

Using Pick & Place Function (continued)

Your Action

If necessary, use the vernier arrows to "fine-tune" the position or size of the gage.

Press and hold the light pen tip against the gage handle, gage, or gage end.

Comments

You can change the gage's size or position more *precisely* by using the *vernier* arrows. The vernier arrows enable you to make these changes in small increments.

You can access the vernier arrows while either *picking* a gage handle or *placing* the gage or gage end.

Hold the light pen tip in for about *one second*. The vernier arrows will then appear in the lower-right corner of the screen:

VERNIER ARROWS

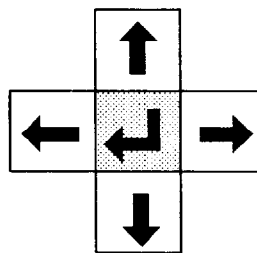

Move entire gage
up, down, left, or
right

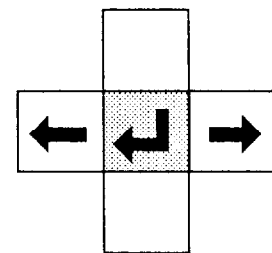

Move gage end
CW or CCW.
Increase or decrease
gage arc and radius.

Pick an arrow once to move the entire gage one pixel in the arrow's direction.

If you picked the "center" handle,

The up, down, right, or left arrow, will move the entire gage *one pixel* in the direction indicated by the arrow.

Pick an arrow once to move the gage end CW or CCW.

or, if you picked a gage-end handle,

The right arrow will move the gage end clockwise (CW); the left arrow will move the gage end counterclockwise (CCW).

Pick an arrow once to change the gage radius and arc.

or, if you picked the "midpoint" handle,

The right arrow will increase the number of degrees in the arc; the left arrow will decrease the arc. At the same time, the radius length will change.

Pick and hold an arrow to change the gage size or position continuously.

When you pick and *hold* an arrow, the gage's size or position will change slowly for the first five or six increments. It will then change at a more rapid rate.

Pick the "return" symbol to release the vernier arrows.

When the gage or gage end is properly positioned, pick the "return" symbol (←|) to *release* the vernier arrows and return to the pick-and-place mode.

**Selecting Define Gage
Popup Menu and
Parameters (continued)**

Using Define Edges Function: Binary Gaging Mode

Pick the Define Edges menu box, then perform the threshold adjustments in order to determine the edge(s) that the gage will be using to measure the workpiece.

If you selected the Gray Scale gaging mode, go to the section called *Using Define Edges Function: Gray Scale Gaging Mode*.

Use the following steps for setting the threshold if you selected the Binary gaging mode.

Your Action

Pick the Define Edges menu box in the Define Gage popup menu.

Comments

If you have selected the Binary gaging mode, when you pick the Define Edges menu box, the Filter popup menu and slide bar appear on the monitor screen, as follows:

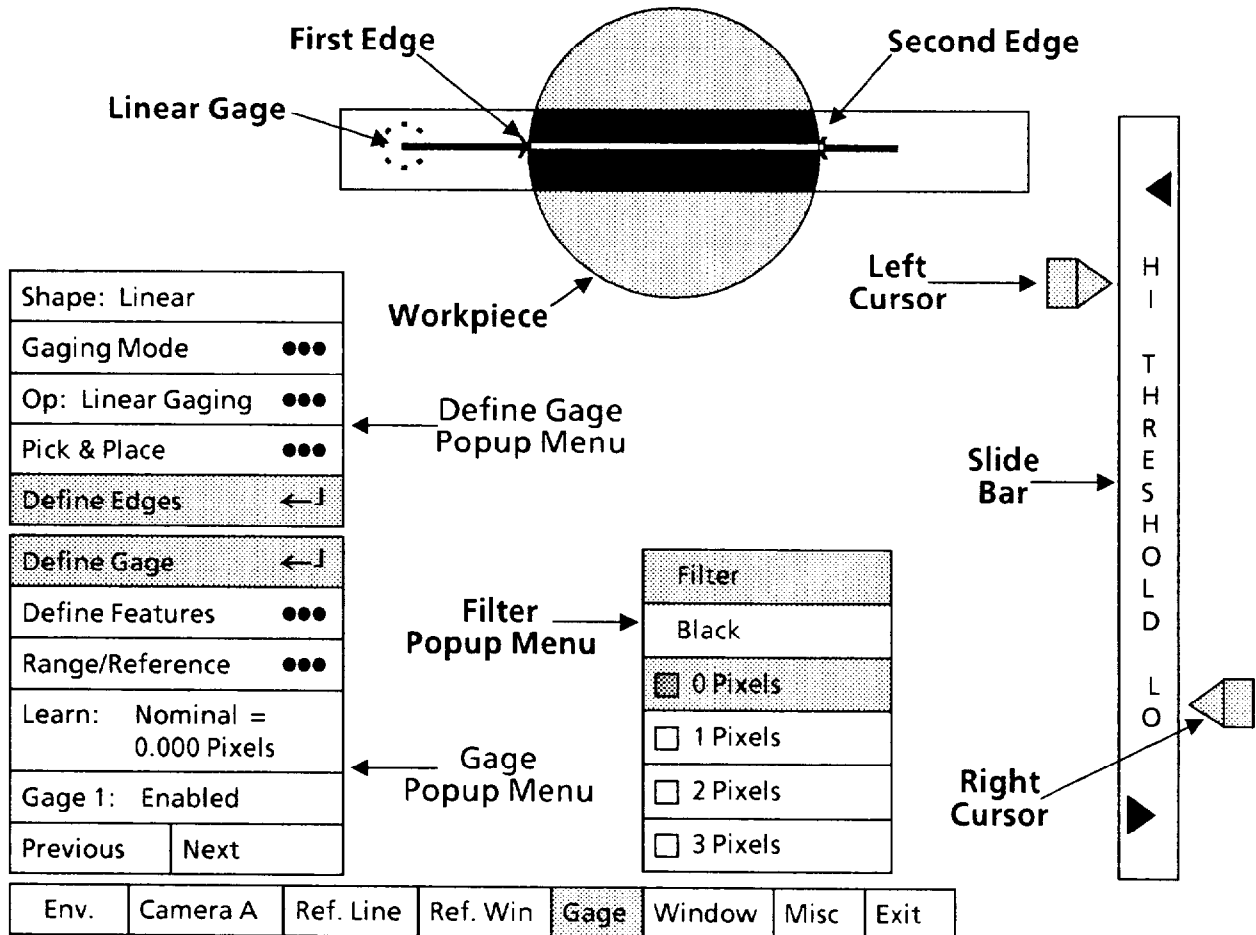

Also on the monitor screen, a small "X" will appear along the gage wherever it "sees" an edge. As shown above, the gage sees *two* edges on the circular workpiece.

If no X's appear, or if too many X's appear, you will need to adjust the threshold cursors and possibly set some value of white or black pixel filtering.

**Selecting Define Gage
Popup Menu and
Parameters (continued)**

**Using Define Edges Function: Binary Gaging Mode
(continued)**

Your Action

Comments

Look at the threshold cursors on each side of the slide bar.

The cursors on each side of the slide bar are the principal means by which you will define "edges" (that is, transitions) that occur along the gage. The gage lies entirely within a box called the "area of interest." This box contains the binarized image. All parts of the image *outside* the box remain in gray scale form.

The cursors' positions along the slide bar represent *image brightness values* from 1 to 63, with 63 at the top and 1 at the bottom.

Think of the *left* cursor this way: Any part of the binary image area having a *higher* brightness value (that is, *lighter*) than the value indicated by the cursor's current setting will appear *black* in the binary image. For example, if the cursor is set to a brightness value of 45, then all parts of the binary image having brightness values *higher than 45* will appear *black*.

Think of the *right* cursor this way: Any part of the binary image area having a *lower* brightness value (that is, *darker*) than the value indicated by the cursor's current setting will appear *black* in the binary image. For example, if the cursor is set to a brightness value of 27, then all parts of the binary image having brightness values *lower than 27* will appear *black*.

Thus, all parts of the binary image having a brightness value *between* the current settings of the two cursors will appear *white*. In the examples above, all parts of the binary image having brightness values from 27 to 45 will appear *white*; all other parts will appear *black*.

Pick left cursor.

Aim the light pen at the cursor. When you see a red box around the cursor, pick the cursor. This causes the cursor to turn yellow, indicating that you can now "drag" the cursor up or down.

Drag the left cursor to its topmost position.

This initializes the left cursor to the "63" brightness value.

Pick and drag the right cursor to its bottommost position.

This initializes the right cursor to the "1" brightness value.

Pick the left cursor again and drag it downward.

Drag the left cursor *downward* until those parts of the binary image that you want to be *white* start to turn black. Then, drag the cursor up slightly until those same areas just change to *white* again.

As you drag the cursor up and down, an X will appear along the gage wherever an edge (binary transition) is detected.

**Selecting Define Gage
Popup Menu and
Parameters (continued)**

**Using Define Edges Function: Binary Gaging Mode
(continued)**

Your Action

Comments

*Pick the right cursor again
and drag it upward.*

Drag the right cursor *upward* until those parts of the binary image that you want to be *black* just turn *black*.

As you drag the cursor up and down, an X will appear along the gage wherever an edge (binary transition) is detected.

*Alternately pick and drag
each cursor until a stable X
appears at each required edge.*

Your objective is to produce a stable X at each edge that the gage must "see" in your application. Other X's may *also* appear along the gage; however, you can configure the system to recognize only the X's at the *required* edges.

Try various positions of the two cursors to produce the most *stable* X's.

Trial and observation is the correct procedure for setting the binary threshold.

Look at the Filter menu.

If white or black "noise" in the image *prevents* you from getting stable X's at the desired edges, try using white or black filtering.

In the Filter menu, the filled-in square () shows the currently selected filter level. This determines the number of consecutive black or white "noise" pixels that will be removed (filtered) before the gage looks for the edges. Black or White determines which *color* of pixel should be considered "noise."

The filter, in effect, masks out the "noise" pixels so that they don't create false edges.

For example, if the filter menu is set to White and 3 Pixels, and the gage encounters three (or fewer) consecutive white pixels in a stream of black pixels, these white pixels are removed (filtered out), and no edge is detected.

If, on the other hand, the gage encounters four (or more) consecutive white pixels, an edge *is* detected (actually, *two* edges will be detected – a leading edge and a trailing edge – if the gage crosses *through* the string of white pixels).

Your objective is to set the filter to a level that removes enough visual "noise" from the binary image to prevent the gage from detecting false edges.

*Pick the White or Black
menu box in the
Filter popup menu.*

This menu box "toggles" between White and Black when you pick it repeatedly. Select White to filter out small white noise, or select Black to filter out small black noise.

**Selecting Define Gage
Popup Menu and
Parameters (continued)**

**Using Define Edges Function: Binary Gaging Mode
(continued)**

Your Action

Comments

Pick the appropriate filter value from the Filter menu.

If your application does *not* need filtering, pick 0 Pixels. Otherwise, try various values of filtering to get the cleanest binary image *and* stable X's at the required edges.

As is the case in setting the binary threshold, trial and observation is appropriate here. You may want to try several filter settings to see which one is best for your particular application.

Using Define Edges Function: Gray Scale Gaging Mode

Use the following steps for setting the threshold/scale if you selected the gray scale gaging mode.

Pick the Define Edges menu box in the Define Gage popup menu.

If you have selected the Gray Scale gaging mode, when you pick the Define Edges menu box, the slide bar appears on the monitor screen, as follows:

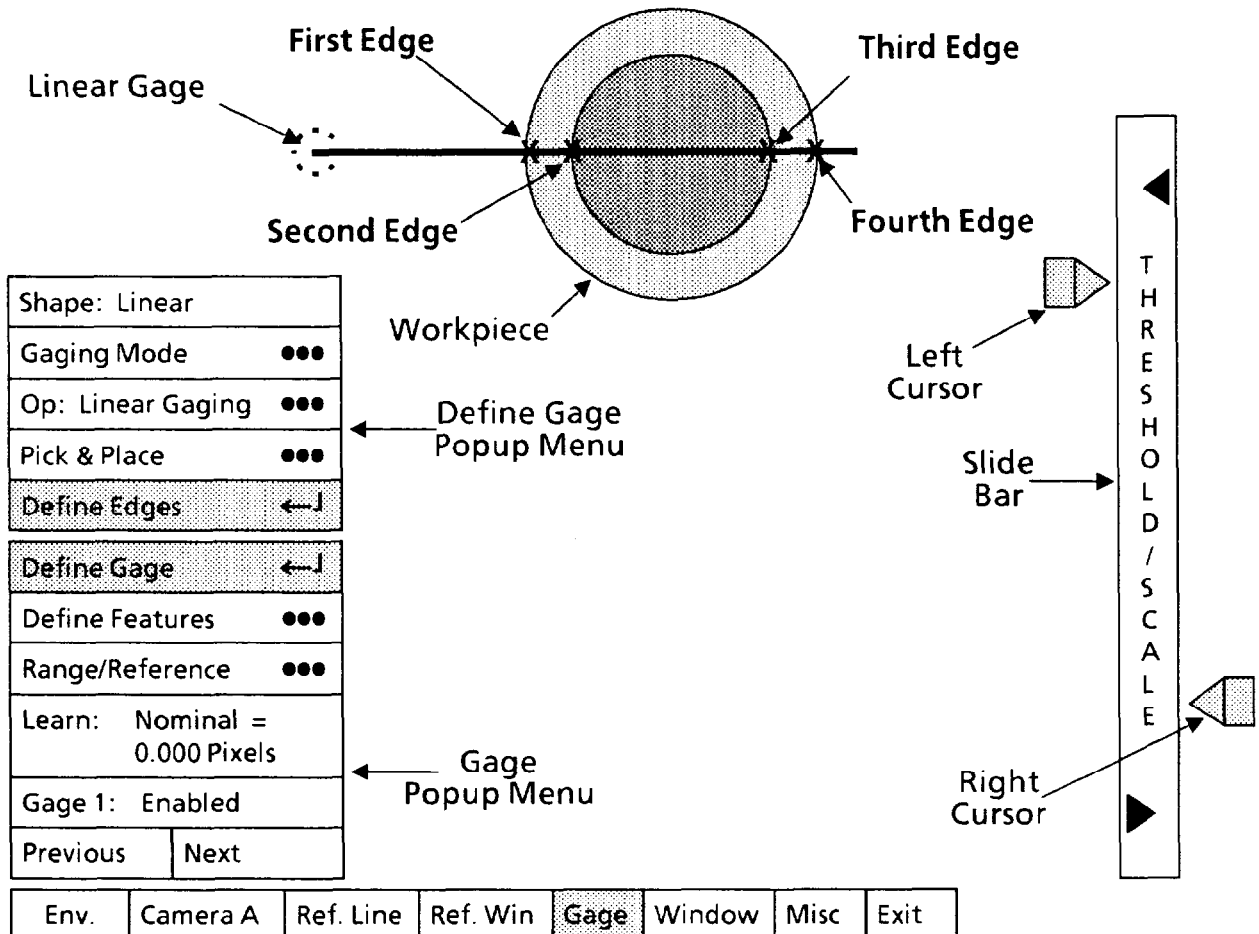

**Selecting Define Gage
Popup Menu and
Parameters (continued)**

**Using Define Edges Function: Gray Scale Gaging Mode
(continued)**

Your Action

Comments

<i>Look at the cursors on each side of the slide bar.</i>	<p>Also on the monitor screen, an "X" will appear along the gage wherever it "sees" an edge. As shown above, the gage sees <i>four</i> edges on the circular workpiece.</p> <p>If no X's appear, or if too many X's appear, you will need to adjust the threshold/scale cursors.</p> <p>The cursors on each side of the slide bar are the principal means by which you will define the gray scale image in which the "edges" (that is, the transitions) occur along the gage.</p> <p>The <i>left</i> cursor represents the current setting of the "gradient threshold." This setting determines the <i>minimum</i> change in brightness value that must occur, <i>within the number of pixels indicated by the scale factor</i>, before the CVIM system can "detect" an edge.</p> <p>When the left cursor is at its <i>lowest</i> position, it selects a gradient threshold value of 0.00. This indicates that <i>any</i> change in brightness value will cause the system to detect an edge. When the cursor is at its <i>highest</i> position, it selects a gradient threshold value of 63.00. This indicates that the system will detect an edge <i>only</i> when the change in brightness value is 63.</p> <p>The <i>right</i> cursor represents the current setting of the "scale factor." This setting determines the <i>number of consecutive pixels</i> that the CVIM system examines to determine whether or not an edge (transition) exists. Note that the larger values of scale factor increase processing time.</p> <p>When the right cursor is at its <i>lowest</i> position, it selects the smallest scale factor (2); and when the cursor is at its <i>highest</i> position, it selects the largest scale factor (41).</p>
<i>Pick the <u>left</u> cursor.</i>	<p>Aim the light pen at the cursor. When you see a red box around the cursor, pick the cursor. This causes the cursor to turn yellow, indicating that you can now "drag" the cursor up and down.</p>
<i>Drag the left cursor to its bottommost position.</i>	<p>This initializes the left cursor to the "0.00" gradient threshold.</p>
<i>Pick and drag the <u>right</u> cursor to its bottommost position.</i>	<p>This initializes the right cursor to the "2" scale factor. At this point, many X's ("edges") may appear along the gage.</p>
<i>Pick the right cursor <u>again</u> and drag it <u>upward</u>.</i>	<p>Drag the cursor <i>upward</i> until the X's at the desired edges are in good, stable locations. Many edges may still be present along the gage.</p>

**Selecting Define Gage
Popup Menu and
Parameters (continued)**

**Using Define Edges Function: Gray Scale Gaging Mode
(continued)**

Your Action

Comments

*Pick the left cursor again
and drag it upward.*

Drag the cursor *upward* until you remove as many of the unwanted X's as possible *without* losing the X's at the required edges of your workpiece.

*Alternately pick and drag
each cursor until stable X's
appears at the required edges.*

Your objective is to produce stable X's at the *required* edges, which are the edges that the gage must "see" in your application. Other X's *may persist* along the gage – you may not be able to eliminate of all extraneous X's. If you are using the linear gaging, wedge angle, or chord angle gaging operations, you can configure the system to recognize only the X's at the two *required* edges.

Using trial and observation, try various positions of the two cursors to produce the most *stable* X's at the required edges.

**Selecting Define Features
Popup Menu and Parameters**

Select the Define Features popup menu, then select the parameters in that menu. Basically, these parameters enable you to specify which edges (or midpoints) are to be used for the gage measurements and the direction of the search for these edges.

NOTE: This popup menu is active *only* for the linear gaging, wedge angle, and chord angle operations.

Your Action

Comments

*Pick the Define Features
menu box in the Gage
popup menu.*

When you pick the Define Features menu box, the Define Features popup menu appears above the Gage popup menu, as follows:

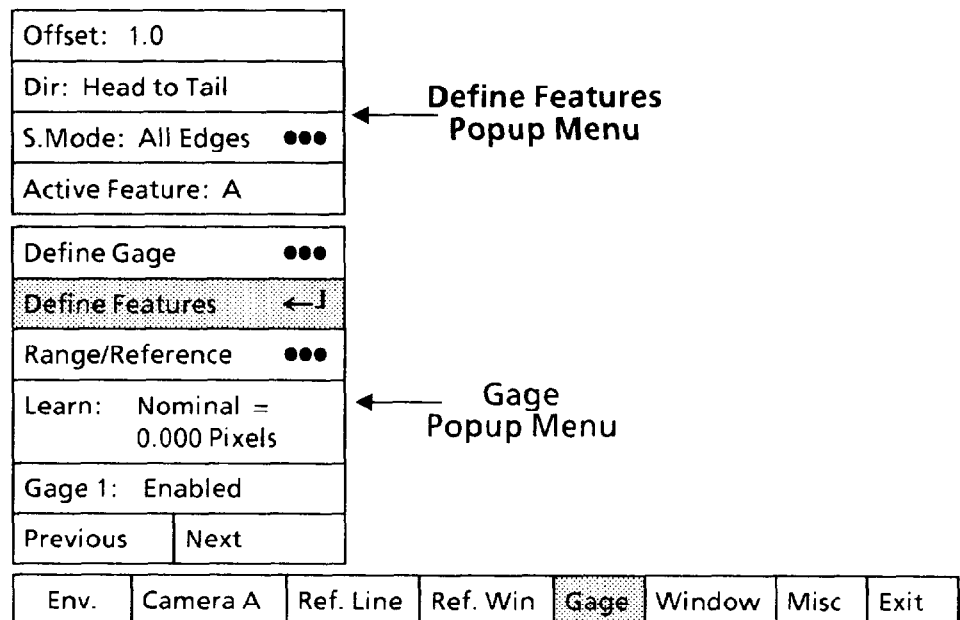

**Selecting Define Features
Popup Menu and Parameters**
(continued)

Notice also the letters **A** and **B** somewhere on the gage. Initially, **A** will appear at the edge nearest the *head* of the gage, and **B** will appear at the edge nearest the *tail* of the gage. Or, if the gage sees *no* edges, **A** will be at the head and **B** will be at the tail of the gage.

In all cases, **A** identifies the edge (or midpoint) location for “active feature” **A**, and **B** identifies the edge (or midpoint) location for “active feature” **B**. *The gage performs its measurement operation from A to B.*

The next several pages contain the procedures for configuring an active feature, namely:

- Selecting either **A** or **B** as the active feature to be configured at this time. You must configure **A** and **B** separately.
- Selecting a search *direction* for the each active feature. You can select the same or different directions for **A** and **B**.
- Selecting a search *mode* for each active feature. The search mode determines which edges **A** and **B** will examine during the edge search operation. You can select the same or different modes for **A** and **B**.
- Selecting the appropriate “offset” for each active feature – the edge (or midpoint) *location* for **A** and **B**.

Selecting Active Feature

This function selects either **A** or **B** as the current active feature. *Each must be configured separately.*

Your Action

Look at the Active Feature menu box in the Define Features popup menu.

Pick the Active Feature menu box, if appropriate.

Comments

The Active Feature menu box indicates the active feature (**A** or **B**) that is currently selected for configuration.

When you pick the Active Feature box, the “active feature” will toggle to the other letter. Thus, **A** will change to **B**, or vice versa.

Selecting Search Direction

Select the direction in which active feature **A** (or **B**) will search for the specified edges.

Your Action

Look at the Dir menu box in the Define Features popup menu.

Pick the Dir menu box, if appropriate.

Comments

The Dir menu box shows the currently selected direction that active feature **A** (or **B**) will use to search for edges. The direction can be either Head to Tail or Tail to Head.

When you pick the Dir menu box, the search direction toggles to the opposite direction. Thus, Head to Tail will change to Tail to Head, or vice versa.

**Selecting Define Features
Popup Menu and Parameters
(continued)**

Selecting Search Direction (continued)

Your Action

Comments

NOTE: The *best* search direction is the one in which the active feature is the least likely to encounter a *false* edge, as follows:

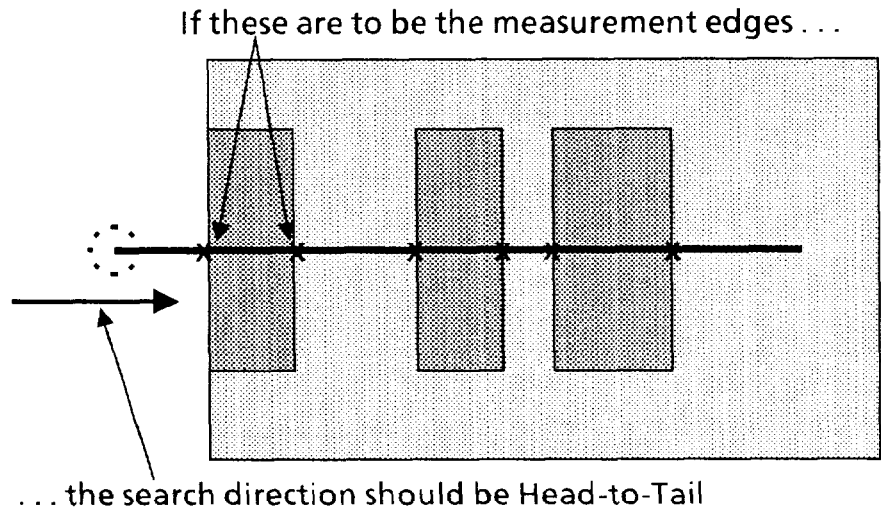

Select the appropriate search direction for the current active feature.

Selecting S. Mode Popup Menu

Select the S. Mode popup menu, then select one of four modes by which active feature **A** (or **B**) will search for edges:

1. Search for *all* edges along the length of the gage.
2. Search *only* for the edges of the largest *white* object along the gage. (This is not available with the gray scale gaging mode.)
3. Search *only* for the edges of the largest *black* object along the gage. (This is not available with the gray scale gaging mode.)
4. Search *only* for the edges of the largest *object* along the gage.

Your Action

Look at the S. Mode menu box in the Define Features popup menu.

Comments

The S. Mode menu box shows the currently selected mode for searching for edges along the gage.

**Selecting Define Features
Popup Menu and Parameters
(continued)**

Selecting S. Mode Popup Menu (continued)

Your Action	Comments
<i>Pick the S. Mode menu box.</i>	When you pick the S. Mode menu box, the Search Mode popup menu will appear on the right side of the screen, as follows:

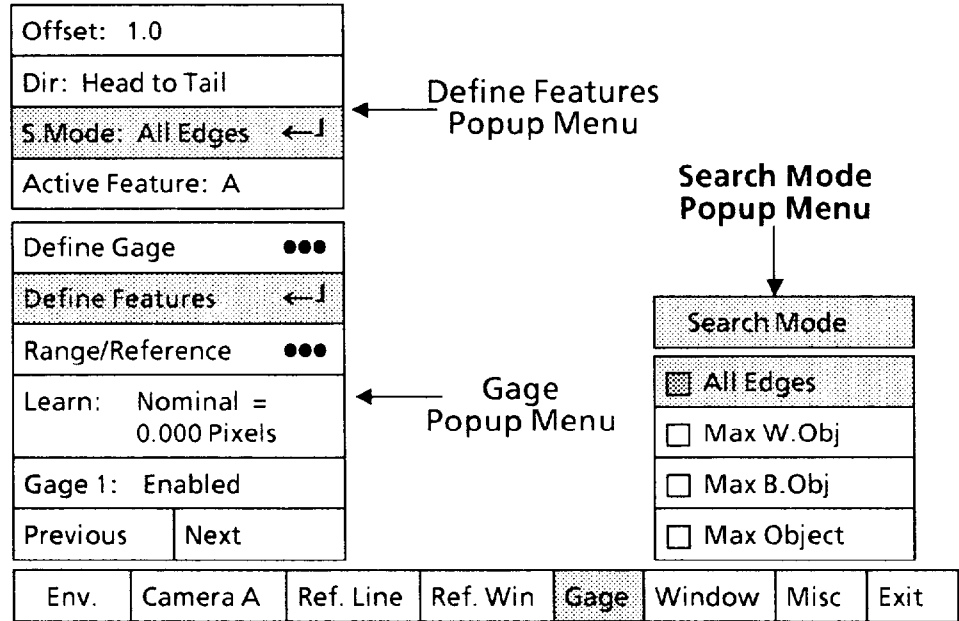

Note that the All Edges box in the Search Mode popup menu has a shaded square (☑). This indicates that All Edges is the currently selected edge search mode.

These are the four edge-search modes in the Search Mode popup menu:

1. **All Edges:** This search mode causes the active feature to search for all edges, all midpoints between edges, and the starting end of the gage.
2. and 3. **Max W. Object:** or **Max B. Object:** These search modes cause the active feature to search for one edge and the midpoint between edges of the largest white (or black) object along a gage. These modes are valid only with the *binary* gaging mode.
4. **Max Object:** This search mode causes the active feature to search for one edge and the midpoint of the largest object between two *consecutive* edges along the gage.

**Selecting Define Features
Popup Menu and Parameters
(continued)**

Selecting S. Mode Popup Menu (continued)

The examples in the following figures show the effects of different combinations of search mode, binary or gray scale mode, and search direction.

In Example #1, the active feature searches the *head* ("fixed"), the *point* between the first and last edge ("center"), and all *edges* and *midpoints* between adjacent edges.

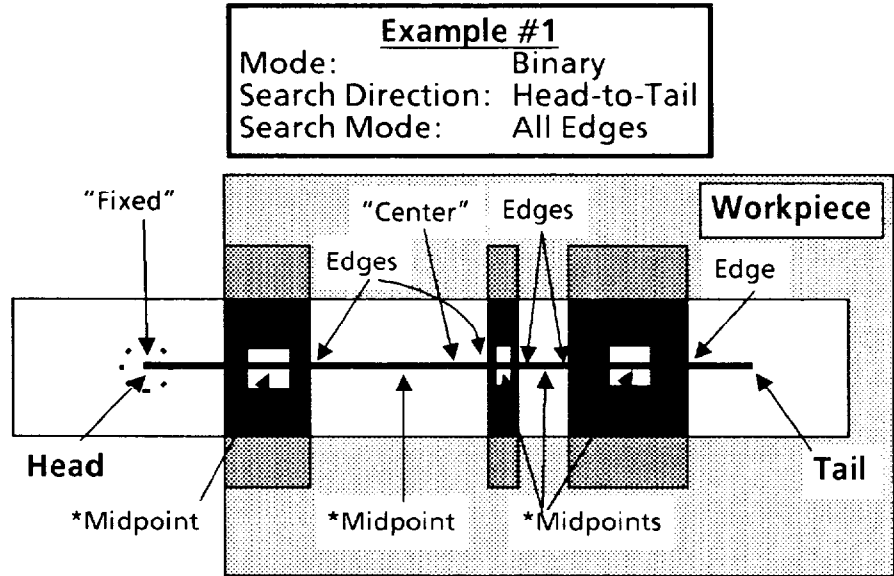

*The small white squares in this figure enable showing the midpoint locations of the black objects. They are not "holes" in the workpiece.

In Example #2, as in example #1, the active feature searches for the *tail* ("fixed"), the *point* between the first and last edge ("center"), and all *edges* and *midpoints* between adjacent edges.

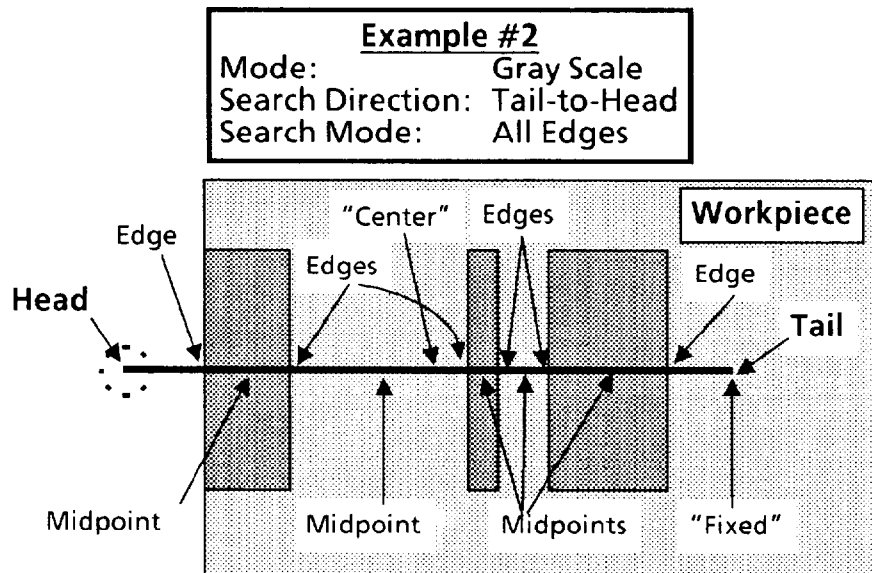

**Selecting Define Features
Popup Menu and Parameters
(continued)**

Selecting S. Mode *Popup Menu* (continued)

In Example #3, the active feature will search *only* for the edge at the *head* side of the largest black object and the midpoint between the two edges of that object.

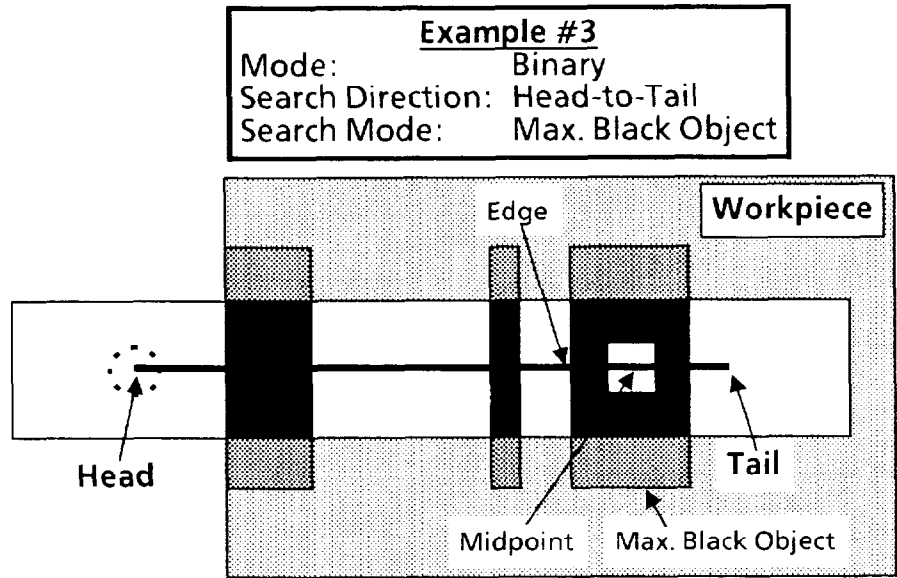

In Example #4, the active feature will search *only* for the edge at the *head* side of the largest *white* object and the midpoint between the two edges of that object.

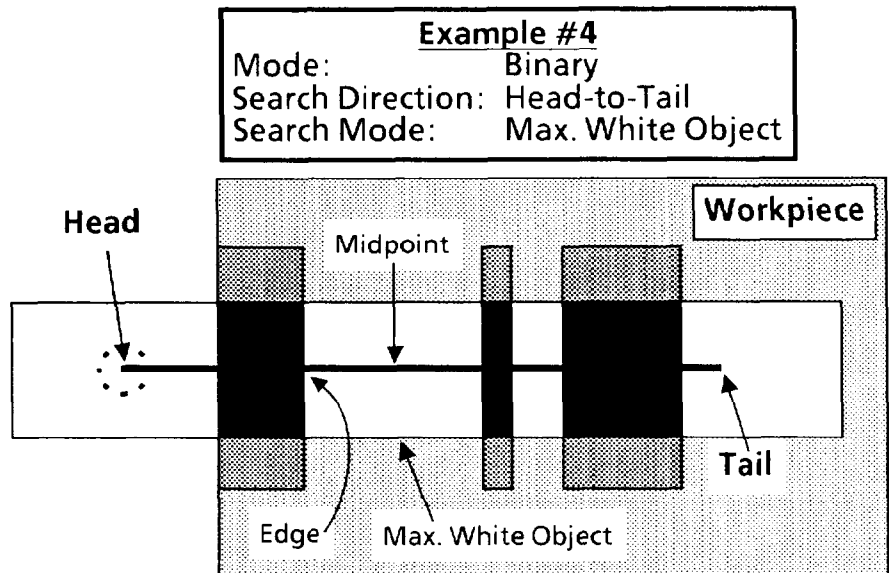

Selecting Define Features Popup Menu and Parameters (continued)

Selecting S. Mode Popup Menu (continued)

In Example #5, the active feature will search *only* for the edge at the *tail* side of the largest *object* (the largest *white* object in example #4) and the midpoint between the two edges of that object.

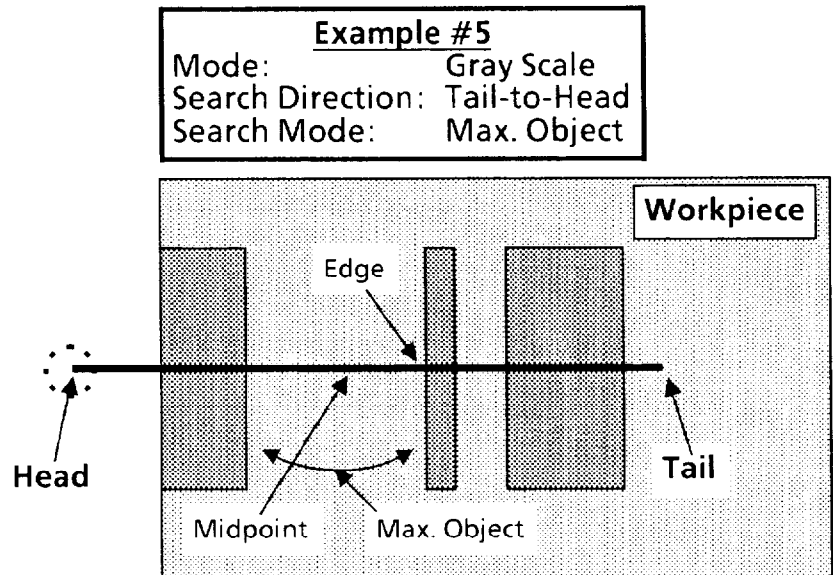

Pick the edge-search mode that is appropriate for your application.

Using Offset Function

Use the Offset function to accurately identify and assign two *specific* edges (or midpoints) as the references for performing the linear or angular measurement.

Your Action

Look at the Offset menu box in the Define Features popup menu.

Comments

The Offset menu box shows the current location of the "active feature" as a number whose value indicates how far the active feature is "offset" from its *starting point* at the head (or tail) of the gage.

An *offset name* refers to a specific point on the gage ("Fixed") or a specific position between the outside edges of the workpiece ("Center").

"Fixed" refers to either the *head* or the *tail* of a gage, according to the designated search direction. For the Head-to-Tail search direction, the fixed point is at the head; for Tail-to-Head, it is at the tail.

"Center" refers to the center point between the first edge and the last edge on the gage.

An *offset number* identifies either a specific *edge* or specific *midpoint* between adjacent edges. The number varies

Selecting Define Features
Popup Menu and Parameters
(continued)

Using Offset Function (continued)

Your Action

Comments

according to the designated search mode. Offset numbers for edges are designated 0.0, 1.0, 2.0, and so on. Offset numbers for midpoints are designated 0.5, 1.5, 2.5, and so on.

For the All Edges search mode, the first offset number is always 1.0, and the last is x.0, where (x) is the total number of edges on the gage.

For the other search modes, the first number is always 0.0, an edge, and the second number is always 0.5, a midpoint.

The example below shows Active Feature A located at offset 1.0, which is edge #1. Note that the *highest* offset number in the example is 6.0, which is the last edge.

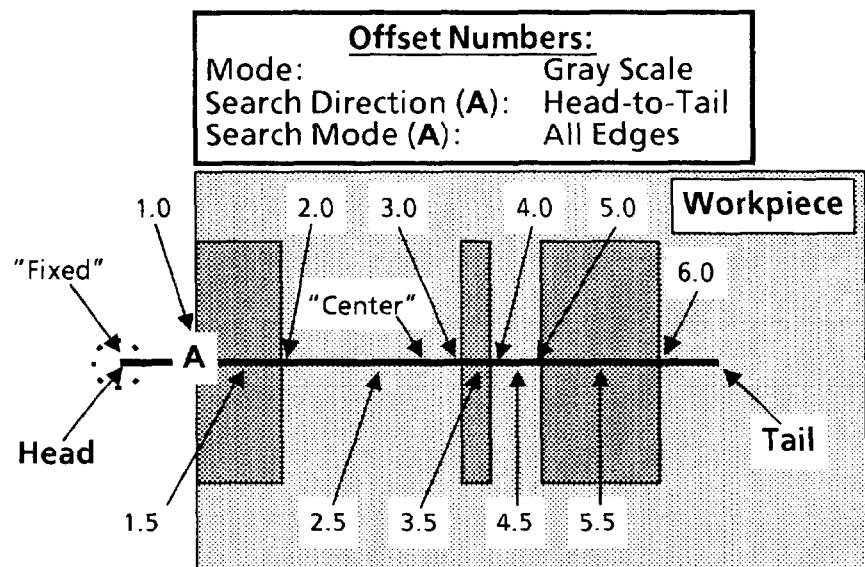

Pick the Offset menu box as needed to position the active feature.

When you pick the Offset menu box, the offset position advances according to the designated search direction. In the example above, it starts with Fixed and continues with Center, 1.0, 1.5, 2.0, and so on.

The *positions* of letters A or B on the gage correspond to their currently selected offsets. Thus, in the preceding figure, A corresponds to offset 1.0, which is edge #1.

When you pick Offset once more after A (or B) reaches the last edge or midpoint, A (or B) returns to the *starting* point, which varies according to the designated search mode and search direction.

For the All Edges search mode, the starting point is either the head or the tail of the reference line, according to the designated search direction, and the offset resets to "Fixed."

For the other search modes, the starting point is the edge of the "object," and the offset resets to 0.0.

Using Learn Function

Pick the Learn menu box in the Gage popup menu to command the CVIM system to “learn” the current count or measurement for the currently selected gage.

Your Action

Comments

Pick the Learn menu box.

When you pick the Learn menu box, the gage “learns” the current count or measurement. The result appears in the Learn menu box.

For counting pixels, objects, or edges, the result is a number such as 100, 58, 7, and so on. For linear and angular measurements, the result is a number such as 0.123, 4.665, or 15.321.

Look at the new value in the Learn menu box.

The new result indicates the current count or measurement for this gage.

Selecting Range/Reference Popup Menu and Parameters

Select the Range/Reference popup menu, then select the parameters in that menu.

Your Action

Comments

Pick the Range/Reference menu box in the Gage popup menu.

When you pick the Range/Reference menu box, the Range/Reference popup menu appears above the Gage popup menu, as follows:

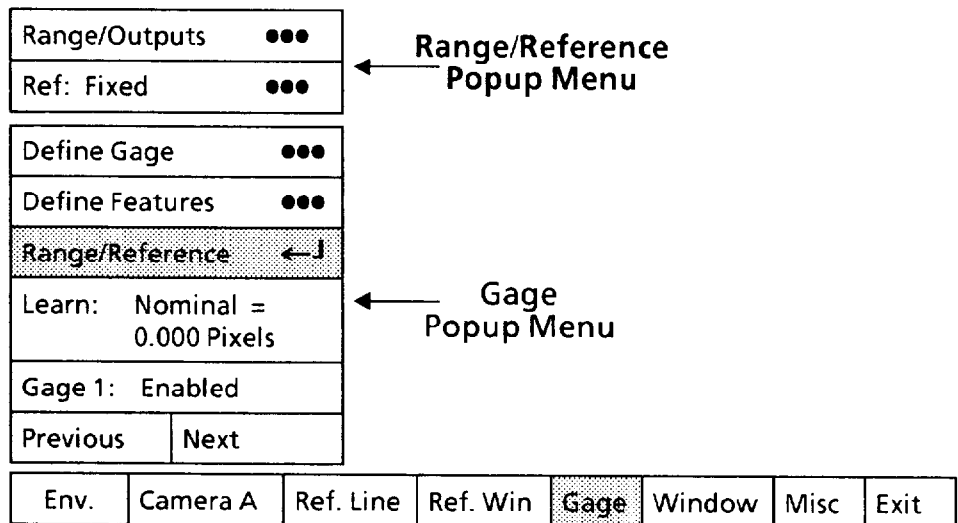

**Selecting Range/Reference
Popup Menu and Parameters**
(continued)

Assigning Range Limits and Output Lines

Range Limits – The term *range limit*, as it applies to a gage, refers to the upper and lower tolerance limits for a gage measurement or counting operation.

In general, range limits specify the upper and lower boundaries of acceptable inspection “results” values. Thus, the “result” value could be a pixel count, object count, or other value from the gage inspection operation.

The CVIM system provides *two* sets of range limits: *Warning range* limits, and *fault range* limits. Warning range limits always lie at or *within* fault range limits.

The two sets of range limits have this relationship:

$$LF < = LW < = REFERENCE < = UW < = UF$$

The **REFERENCE** value could be the “nominal” value from a Learn operation, or a “mean” value from a trial inspection series. For example, if the **REFERENCE** value were 1.50 inches,

- The **LW** value (lower warning limit) could be set to 1.48 inches.
- The **UW** value (upper warning limit) could be set to 1.52 inches.
- The **LF** value (lower fault limit) could be set to 1.46 inches.
- The **UF** value (upper fault limit) could be set to 1.54 inches.

If an inspection result value goes outside either warning limit, the CVIM system will generate a warning signal. If the value goes outside *both* a warning limit *and* a fault limit, the CVIM system will generate both a warning signal *and* a fault signal.

In a practical application, the warning range limits can be used to indicate a deteriorating condition, such as a cutting tool starting to wear out, and the fault limits can be used to indicate a “hard” failure, such as a broken cutting tool.

Output Lines – The term *output lines* refers to the 14 discrete output lines assigned to carry various signals to your production equipment. Of these signals, the “results” signals indicate whether or not any of the warning and/or fault range limits have been exceeded.

Here are a couple of examples of using the warning and fault range limits and their corresponding output lines:

Example 1: If the dimensions of stamped-out parts change as the die wears, and one of the dimensions drifts outside the specified warning limit, the CVIM system will issue a signal to the “results” output line that you specified for the gage’s warning signal. The inspection processing would then continue.

Selecting Range/Reference Popup Menu and Parameters (continued)

Assigning Range Limits and Output Lines (continued)

The warning signal could be used to inform operations personnel that the die needs to be replaced soon, but not necessarily right away. They could then plan to replace the die at a convenient time, such as a shift change, rather than being forced to shut down during a shift.

Example 2: If a stamping die breaks, the dimensions of the stamped-out parts could change abruptly outside both the warning limit and the fault limit. In this case, the CVIM system will issue both a warning signal and a fault signal to the specified "results" output lines, and the inspection processing would then stop.

The fault signal could be used to inform operations personnel that the tool needs to be replaced right away.

NOTE: Two procedures are available for determining the appropriate range limits for your application: The *shorter* procedure is to use the Learn function described earlier. The *longer* procedure is to run a series of inspections on a representative sample of workpieces in order to accumulate a *statistical* basis for setting the range limits.

The following steps describe the *shorter* procedure using the Learn function:

Your Action	Comments
Position a "perfect" workpiece in the screen image.	The "perfect" workpiece should be one on which the dimension or other characteristic that the gage is to measure or count is in the <i>middle</i> of the tolerance range; that is, ± 0 .
Perform a Learn function, as described earlier.	Before you perform the "learn" function, be sure the gage is properly positioned over the workpiece in the screen image and the edges are properly defined. Pick the Learn menu box to perform the Learn function.
Look at the result in the Learn menu box.	The new result is the current count or measurement for this "perfect" workpiece. Record the result value.
Position a <u>minimum</u> -tolerance workpiece in the screen image.	The "minimum-tolerance" workpiece should be one on which the workpiece dimension or other characteristic is at the <i>low end</i> of the tolerance range. This the dimension or characteristic <i>below</i> which the workpiece is <i>unacceptable</i> .
Perform a second Learn function.	Pick the Learn menu box to perform the Learn function again, and record the result value.

**Selecting Range/Reference
Popup Menu and Parameters
(continued)**

Assigning Range Limits and Output Lines (continued)

Your Action

Comments

*Position a maximum-tolerance
workpiece in the screen image.*

The "maximum-tolerance" workpiece should be one on which the workpiece dimension or other characteristic is at the *high end* of the tolerance range. This the dimension or characteristic *above* which the workpiece is *unacceptable*.

*Perform a third Learn
function.*

Pick the Learn menu box to perform the Learn function again, and record the result value.

The three result values are the ones you will use to determine the fault range limits. Continue now with the procedure for configuring the range limits.

The following steps describe the *longer* procedure using a series of inspections:

Your Action

Comments

*Prepare to run a series of
"trial" inspections.*

Refer to Chapter 10, *Runtime Operations* for more details about the following steps.

For these trial inspection series, you should have on hand a sufficiently large quantity of representative workpieces. You can either place them in front of the camera manually and use a manual trigger, or use some type of automatic positioning and triggering mechanism that simulates the actual factory-floor situation.

*Pick the Exit menu box in the
Main Configuration menu.*

When you pick the Exit menu box, the Exit popup menu will appear.

*Pick the Runtime Init. menu
box in the Exit menu.*

When you pick the Runtime Init. menu box, the Runtime Init. popup menu will appear.

*Look at the Mode menu box
in the Runtime Init. menu.*

If the word "Standard" appears, pick the box *once* to toggle to "Learn." This activates the "learn" mode during the trial inspection series and ensures the accumulation of gage "results" data in the statistics tables.

*Pick the Runtime Display menu
box in the Exit menu.*

When you pick the Runtime Display menu box, the Runtime Display popup menu will appear.

*Pick the Stat. Page 1 menu
box in the Runtime
Display menu.*

The Stat. Page 1 menu box causes page one of the statistics tables to appear on the monitor screen when you activate the run mode. Page one displays "results" statistics for all *enabled* gages.

**Selecting Range/Reference
Popup Menu and Parameters
(continued)**

Assigning Range Limits and Output Lines (continued)

Your Action

Comments

*Pick the Runtime menu
box in the Exit menu.*

When you pick the Runtime menu box, the Runtime popup menu will appear.

*Pick the Goto Runmode menu
box in the Runtime menu.*

When you pick the Goto Runmode menu box, the CVIM system will begin running inspections *if you selected Auto/Internal as the trigger source*. If not, the system will await trigger inputs from whatever trigger source you selected.

Look the statistics table.

As the inspections continue, the Stat. Page 1 table will display accumulated "results" data *only* for each *enabled* gage. *No* data will appear for a gage that is *not* enabled.

*When you have enough
inspections, look at the
four statistics columns
in the Stat. Page 1 table.*

These columns show the *mean, standard deviation, minimum reading, and maximum reading* statistics for the inspection series.

These statistics are your basis for configuring the range limit values for the currently selected gage.

*Pick the Setup menu box
to stop the runmode.*

Picking the Setup menu box *stops* the run mode and returns the CVIM system to the configuration mode.

At this time, the *final* data appearing in the Stat. Page 1 table are recorded in the Inspection Statistics table for the currently selected gage. You will see this when you pick the Range/Outputs menu box in the Range/Reference popup menu.

Pick the Gage menu box.

This restores the Gage popup menu.

Select the gage number.

This restores the gage number whose range limits you want to set.

*Pick the Range/Reference
menu box.*

This restores the Range/Reference popup menu.

**Selecting Range/Reference
Popup Menu and Parameters
(continued)**

Assigning Range Limits and Output Lines (continued)

Use the following steps to set range limits and assign output lines.

Your Action

Comments

Pick the Range/Outputs menu box in the Range/Outputs popup menu.

When you pick the Range/Outputs menu box, two tables will appear on the screen, as follows:

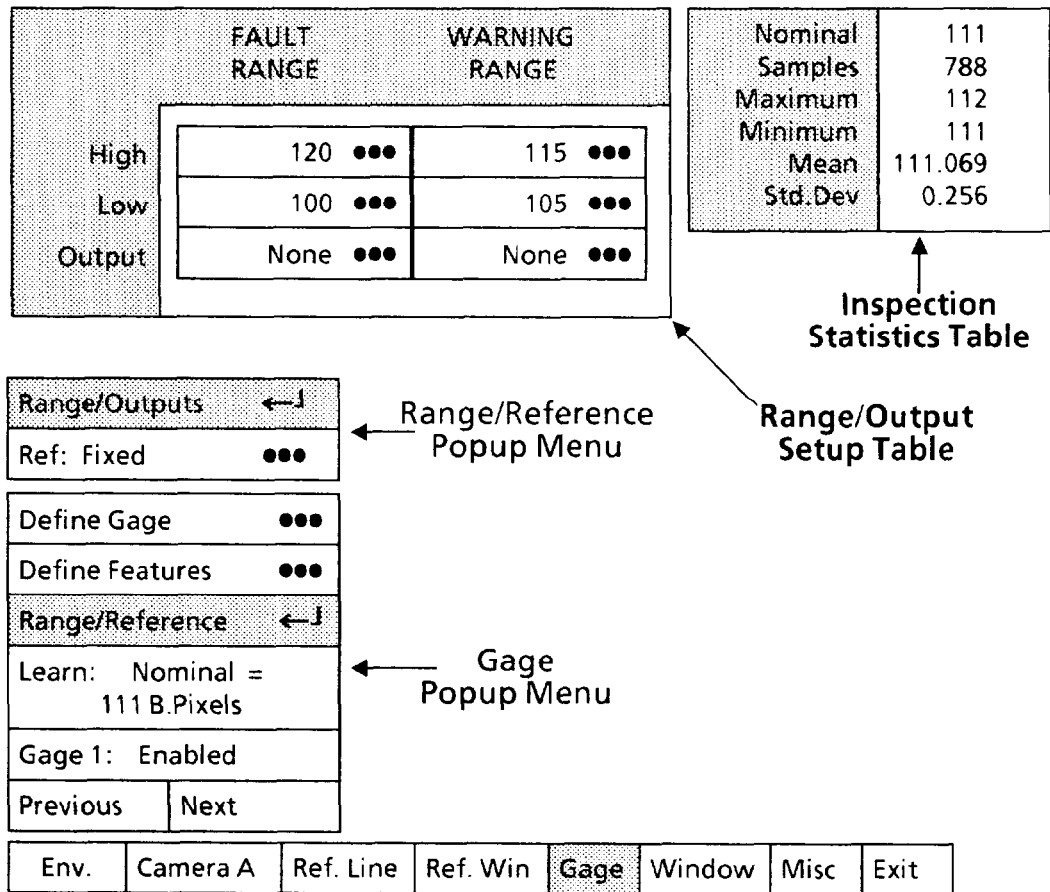

The Range/Outputs setup table is the one you will use to set the range limits and assign the output lines. The numbers appearing in it now are the limits and lines set previously. Note that each box in the table has the three dots (●●●), which indicates that you will need to pick each box, one at a time, in order to set its value.

The Inspection Statistics table shows the statistical accumulation of inspection "results" data if you performed a series of inspections with the CVIM system running in the "learn" mode. These numbers can help you choose the best values for the range limits.

**Selecting Range/Reference
Popup Menu and Parameters
(continued)**

Assigning Range Limits and Output Lines (continued)

The next several steps show you how to enter values for the range limits.

NOTE: The order in which these steps are presented may not be the appropriate order in *all* cases. If not, a blinking message will appear in the calculator display that says: VALUE OUT OF RANGE. For example, this message will appear if you attempt to change the *upper* warning range limit to a value below the *lower* warning range limit.

Your Action

Comments

Pick the upper box under WARNING RANGE.

This is the warning range upper (“High”) limit. When you pick this box, the calculator pad appears on the screen, as follows:

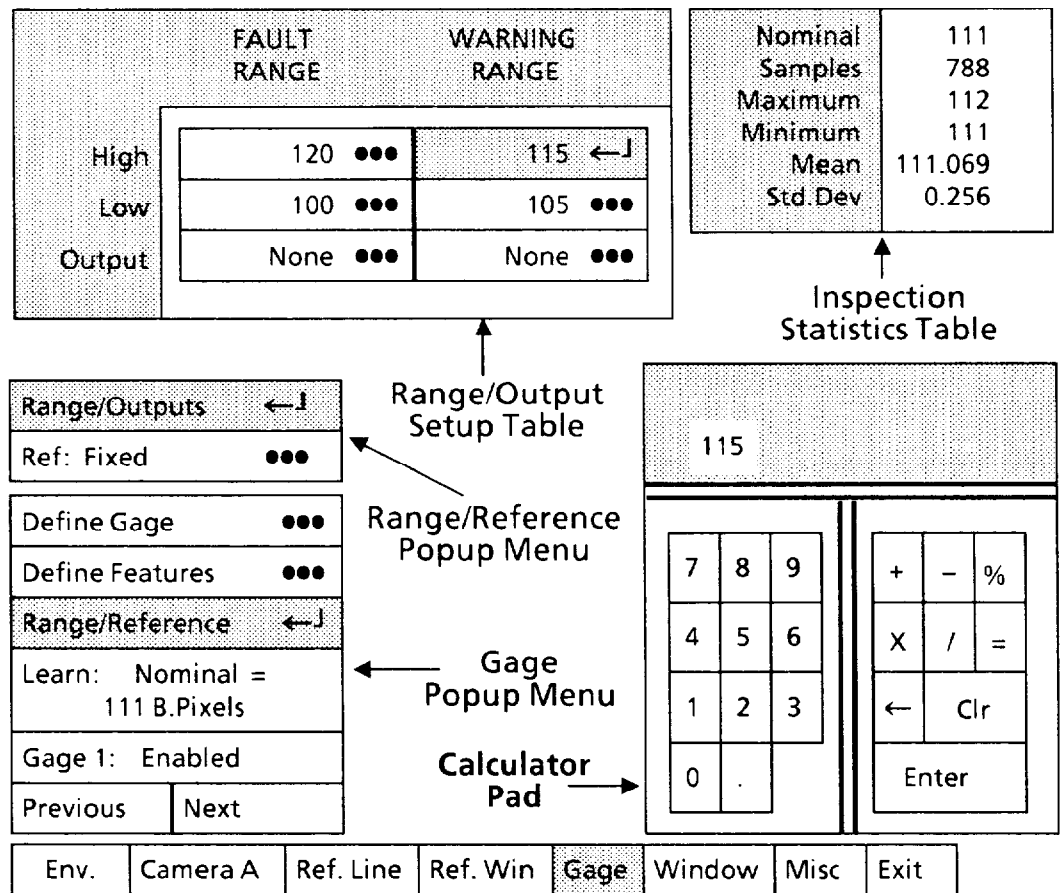

Pick each digit of the upper warning limit value.

As you pick each digit, it will appear in the calculator “display.” Thus, for a value of 50, pick “5,” then pick “0.”

Pick the Enter key.

When you pick the Enter key, the new value will appear in the upper box under WARNING RANGE.

Pick the middle box under WARNING RANGE.

This is the warning range lower (“Low”) limit.

Pick each digit of the lower warning limit value.

As you pick each digit, it will appear in the calculator “display.”

**Selecting Range/Reference
Popup Menu and Parameters
(continued)**

Assigning Range Limits and Output Lines (continued)

Your Action

Comments

Pick the Enter key.

When you pick the Enter key, the new value will appear in the middle box under WARNING RANGE.

*Pick the upper box under
FAULT RANGE.*

This is the fault range upper ("High") limit.

*Pick each digit of the upper
fault limit value.*

As you pick each digit, it will appear in the calculator "display."

Pick the Enter key.

When you pick the Enter key, the new value will appear in the upper box under FAULT RANGE.

*Pick the middle box under
FAULT RANGE.*

This is the fault range lower ("Low") limit.

*Pick each digit of the lower
fault limit value.*

As you pick each digit, it will appear in the calculator "display."

Pick the Enter key.

When you pick the Enter key, the new value will appear in the middle box under FAULT RANGE.

*Pick the lower box under
WARNING RANGE.*

When you pick this box, a variation of the Output Assignment popup menu appears on the screen, as follows:

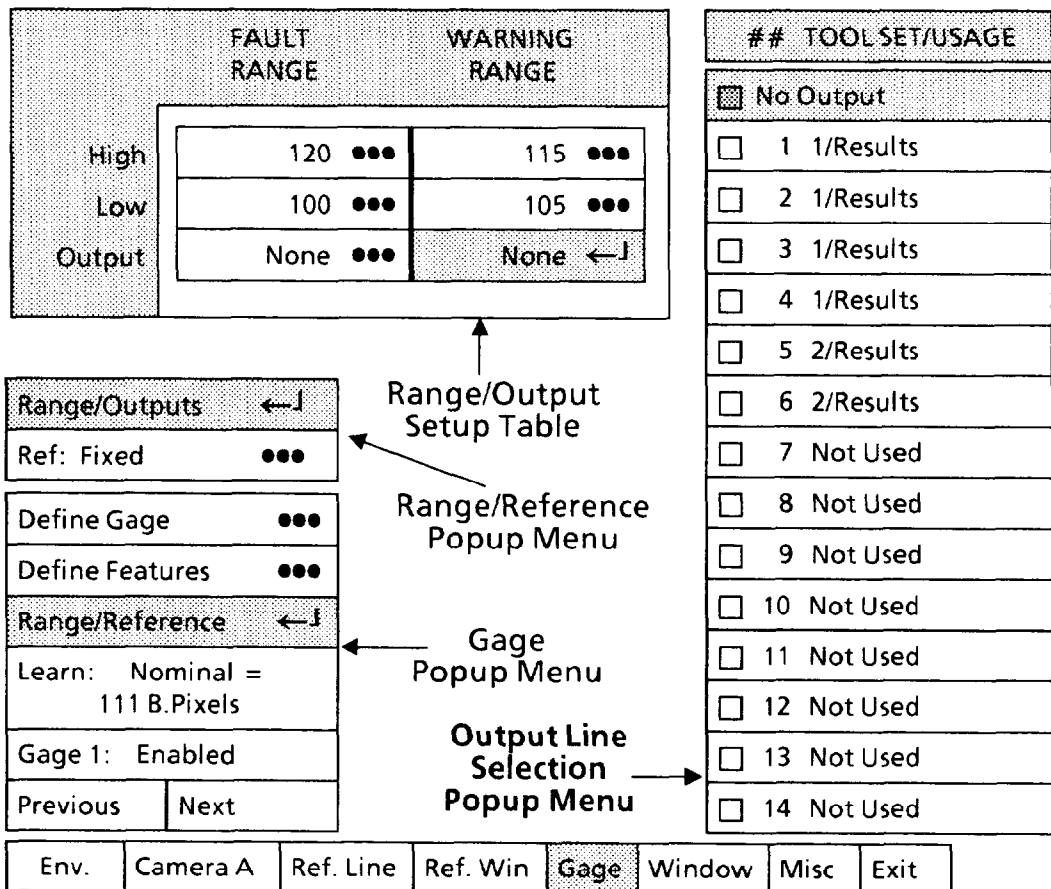

**Selecting Range/Reference
Popup Menu and Parameters
(continued)**

Assigning Range Limits and Output Lines (continued)

Your Action

Comments

This is the Output Line Selection popup menu. It shows the output line functions that you assigned to the Output Assignment popup menu in Chapter 4, *Operating Environment*.

NOTE: This menu shows that only the output lines that you designated in Chapter 4 as "1/Results" are available to this gage if it is in tool set #1 ("2/Results" if the gage is in tool set #2). These appear in light type, and all others appear in **black type** (meaning that you cannot pick them).

Note also that the No Output box in the Output Line Selection popup menu has a shaded square (◻). This indicates that *no* output line is currently assigned to carry WARNING RANGE signals for this gage.

If you prepared an Output Line Planning Sheet in Appendix A, refer to it for the output line assignments for this gage.

*Pick the output line number
for the WARNING RANGE.*

From the Output Line Selection popup menu, pick one of the available output lines boxes labeled "1/Results". When you pick the appropriate box, the shaded square will shift to it.

In addition, the output line number appears in the lower box under WARNING RANGE.

*Pick the lower box under
FAULT RANGE.*

*Pick the output line number
for the FAULT RANGE.*

From the Output Line Selection popup menu, pick one of the available output lines boxes labeled "1/Results". When you pick the appropriate box, the shaded square will shift to it.

In addition, the output line number appears in the lower box under FAULT RANGE.

**Selecting Range/Reference
Popup Menu and Parameters**
(continued)

Selecting Reference Popup Menu

Select the Reference popup menu, if appropriate, then assign a reference tool to provide shift and/or rotation compensation to the currently selected gage.

You can configure CVIM so that one of the six reference tools provides shift compensation to a gage. During an inspection, if the reference tool detects shift and/or rotation in the workpiece, it shifts and/or rotates the gage a corresponding amount and direction.

Use the following steps to select a reference tool for the currently selected gage.

Your Action

Comments

Look at the Ref menu box in the Range/Reference popup menu.

The Ref menu box shows the currently selected reference tool assigned to *this* gage.

Pick the Ref menu box.

When you pick the Ref menu box, the Reference popup menu appears, as follows:

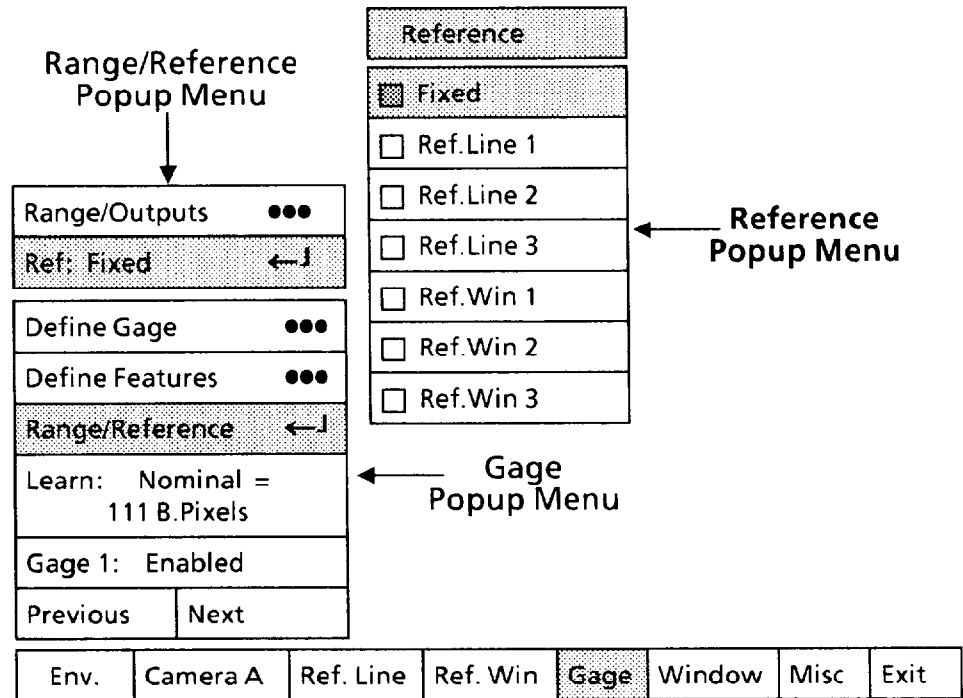

Note that the Fixed box in the Reference menu has a shaded square (◻). This indicates that a reference tool is not currently assigned to *this* gage. Also note that only the *available* reference tools are in *light* type. All others are shown in **black** type, which indicates that you cannot pick them.

Pick the appropriate reference tool from the menu.

If appropriate, pick one of the available reference tools from the Reference menu.

Chapter 8 Inspection Tools: Windows

Chapter Objectives

The objectives of this chapter are to explain windows and show you how they can be used, and then show you the procedures for configuring them. The chapter begins with a series of questions and answers about windows.

A Few Questions and Answers About Windows

This part of the chapter introduces you to windows by asking a few questions about them that might occur to you, and then answering those questions.

What is a window?

A window is a two-dimensional image analysis tool whose size and shape can be adjusted to inspect a specific part of the workpiece image.

What does a window actually look for?

A window looks at all of the *pixels* – points of variable light intensity – within its boundaries. It can look for specific numbers of black or white pixels, specific numbers of objects *formed* of black or white pixels, and so on.

How does a window look for pixels?

A window scans the area within its boundaries, left-to-right, top-to-bottom, evaluating every pixel along the way.

What kind of information can these pixels provide?

If a cluster of black or white pixels represents a particular feature (such as a hole) on a workpiece, counting those pixels can indicate the relative *area* of that feature.

Similarly, counting separate clusters of black or white pixels can indicate the *number* of features or objects within the window's boundaries.

By measuring the gray-scale light level of all pixels within its boundaries, the window can determine their *average* luminance.

By recording the gray-scale image of a particular feature on a workpiece, a window can later search for this *same* feature on other workpieces.

What shapes can a window have?

A window has one of three shapes: rectangular, elliptical, or polygonal.

What are the position, size, and other limits of these windows?

A window can be any length or width, and can be positioned anywhere, so long as it remains within the useable portion of the video monitor screen.

A Few Questions and Answers About Windows (continued)

How many windows are available?

The CVIM system provides 24 windows for each of the two tool sets, for a total of 48. Each window can be rectangular, elliptical, or polygonal.

What functions can a window perform?

A window's function during each inspection cycle is one of these:

- Count the number of black or white *pixels* within the window.
- Count the number of black or white *objects* within the window.
- Compare a specific workpiece feature with a "template" of that feature taken from an ideal workpiece and stored in the CVIM system's memory.
- Calculate the average luminence, or light intensity, of a part of a workpiece.

Windows

This part of the chapter provides you with the details of using and configuring windows of all shapes.

Under the *Using Rectangular Windows*, *Using Elliptical Windows*, *Using Masks with Windows*, and *Using Polygonal Windows* headings, you will see simple application examples of the three window shapes.

Under the *Configuring Windows* heading, you will find out how to use the "user interface" – the light pen and the popup menus on the video monitor screen – to configure windows for inspection tasks.

Using Rectangular Windows

This section describes how you can use *rectangular* windows to inspect a workpiece or parts of a workpiece. (Note that the term "rectangular" includes *square* windows.)

The following examples use rectangular windows to determine whether holes have been punched in a metal plate. The assumptions are as follows:

- The metal plate is backlit.
- Rectangular windows will be used for these operations:
 - Count black pixels, which represent the opaque metal in the plate.
 - Count the white pixels that represent just the holes in the plate.
 - Count the white objects that represent just the holes in the plate.

Using Rectangular Windows
(continued)

- Shift and rotation compensation will *not* be used. (For information on shift compensation, see Chapter 6, *Reference Tools: Lines and Windows*.)

The objective of these inspection examples is for the CVIM system to inspect every plate for the correct area or number of holes and reject all plates with incorrect area or number of holes.

Example 1: Figure 8.1 shows how the image of the metal plate might look on your video monitor screen.

Figure 8.1 Screen Image of Metal Plate

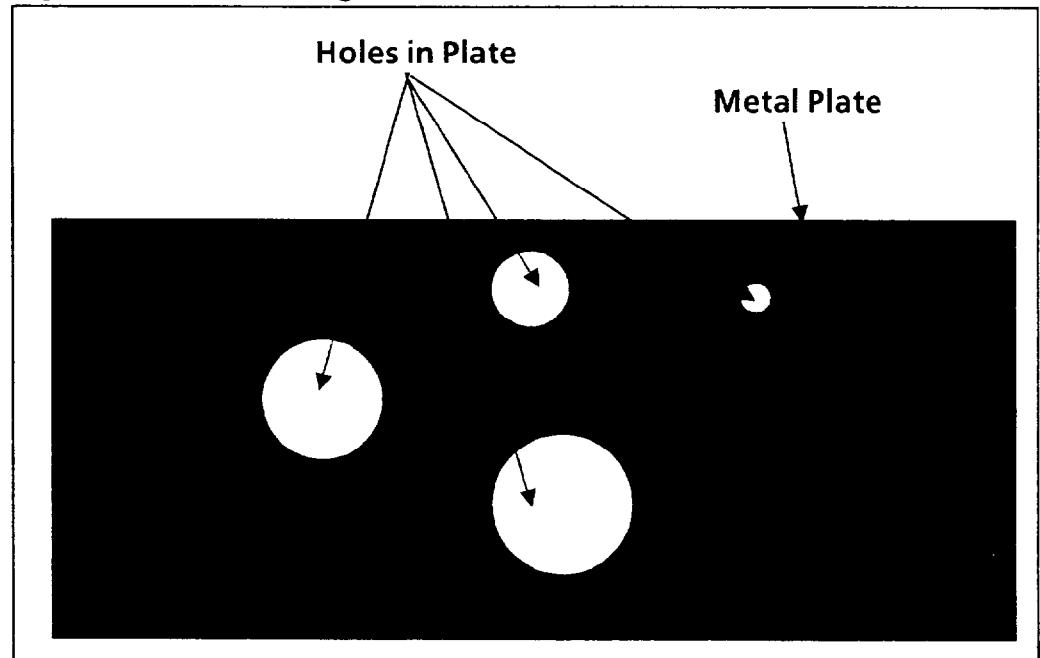

Since the metal plate is opaque, it appears black when lighted from behind. The holes in the plate appear white, and so does the area around the plate.

The window's function in this example is simply to *count the black pixels* within its boundaries.

By counting black pixels, the window is, in effect, measuring the *area* of the metal plate. Thus, if any hole is either missing or incompletely punched, the area of the plate – the number of black pixels – will be *greater* than expected. If there are too many holes, or if any hole is much too large, the area will be *smaller* than expected.

In each case, the CVIM system will issue a "pass/fail" signal that you can use to control your production equipment. For example, you could have the production equipment send the defective part to a reject bin.

Using Rectangular Windows
(continued)

Figure 8.2 shows how a rectangular window might appear when it is positioned *around* the metal plate. Note that the window needs to be just large enough to enclose the plate. This allows for a small amount of plate shift along the X and Y axes of the image on the monitor screen.

Figure 8.2 Rectangular Window Around Metal Plate

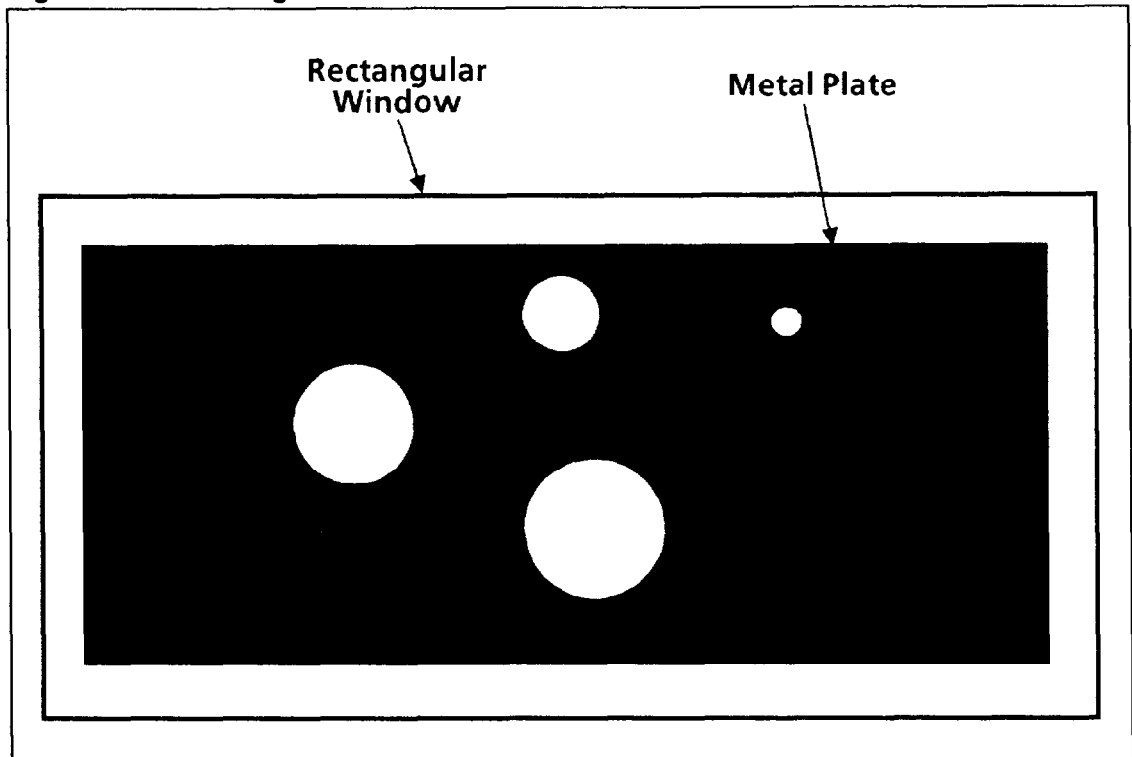

Note that in this example shift and rotation compensation are not used. Thus, each plate must be in a nearly fixed position within the window. The plate cannot be allowed to shift or rotate so that part of it lies *outside* the window.

During an inspection operation, the window counts the black pixels. If the black pixel count is within range limits (that you specify), the plate "passes" inspection; if not, the plate "fails" inspection.

Example 2: Another way of using a rectangular window is to position it *inside* the plate so that the CVIM system can count the white pixels in the four holes, as shown in Figure 8.3. In effect, the window in this case would measure the *sum* of the areas of the four holes.

During an inspection operation, the window counts the white pixels. If the white pixel count is within range limits (that you specify), the plate "passes" inspection; if not, the plate "fails" inspection.

Using Rectangular Windows
(continued)

Thus, if any hole is either missing or incompletely punched, the sum of the hole areas – the total number of white pixels – will be *smaller* than expected. If there are too many holes, or if any hole is too large, the sum will be *greater* than expected.

In each case, the CVIM system will issue a “pass/fail” signal that you can use to control your production equipment.

Figure 8.3 Rectangular Window Positioned Around Holes in Metal Plate

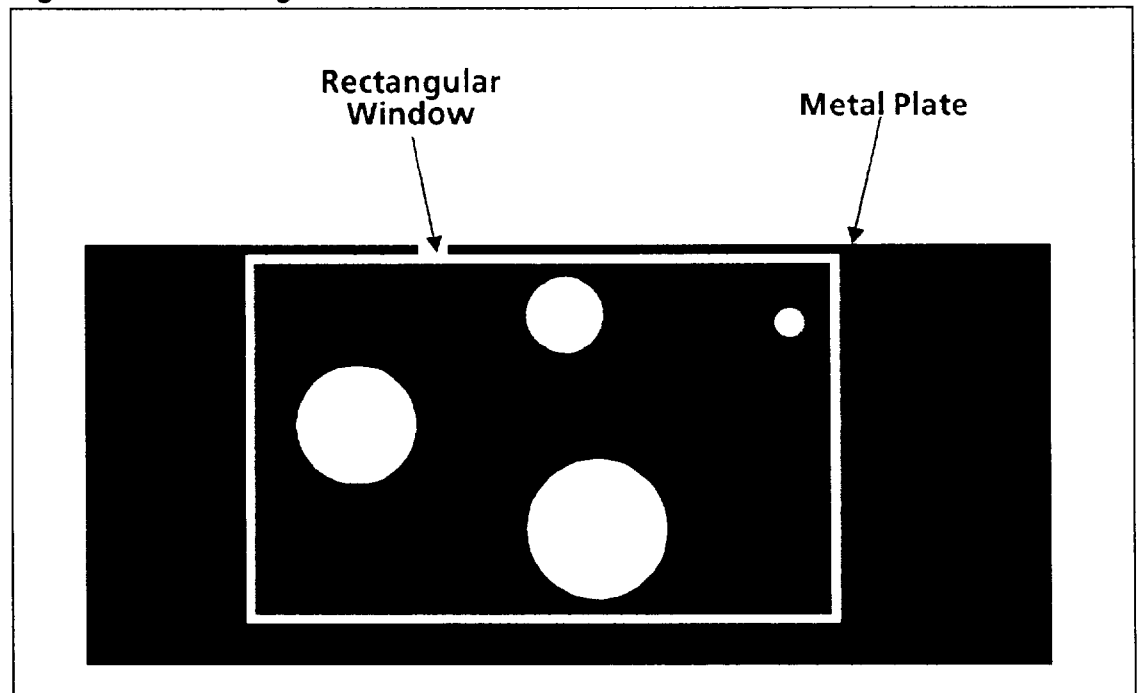

Example 3: Another way of using the rectangular window in Figure 8.3 is to have the CVIM system count the number of white *objects* – the four holes.

Thus, if any hole is missing, or if there are too many holes, the CVIM system will issue a “pass/fail” signal.

Using Elliptical Windows

This section describes how you can use *elliptical* windows to inspect a workpiece or parts of a workpiece. (Note that the term “elliptical” includes *circular* windows.)

Example 1: This example uses circular windows to determine whether the two holes in a metal plate are the correct size. The assumptions are these:

- The metal plate is backlit; thus, the plate will appear black and the holes white on the monitor screen.

Using Elliptical Windows
(continued)

- The CVIM system will use *two* circular windows to count the white pixels from the holes.
- Shift and rotation compensation will *not* be used. (For information on shift compensation, see Chapter 6, *Reference Tools: Lines and Windows*.)

The objective for the CVIM system in this example are to inspect each hole for the correct area.

The CVIM system will reject all plates with missing holes or holes having an incorrect area.

Figure 8.4 shows the image of a plate with two punched holes, each of which has a circular window around it (the circular window is shown as a thin white circle).

Figure 8.4 Circular Windows Around Holes in Metal Plate

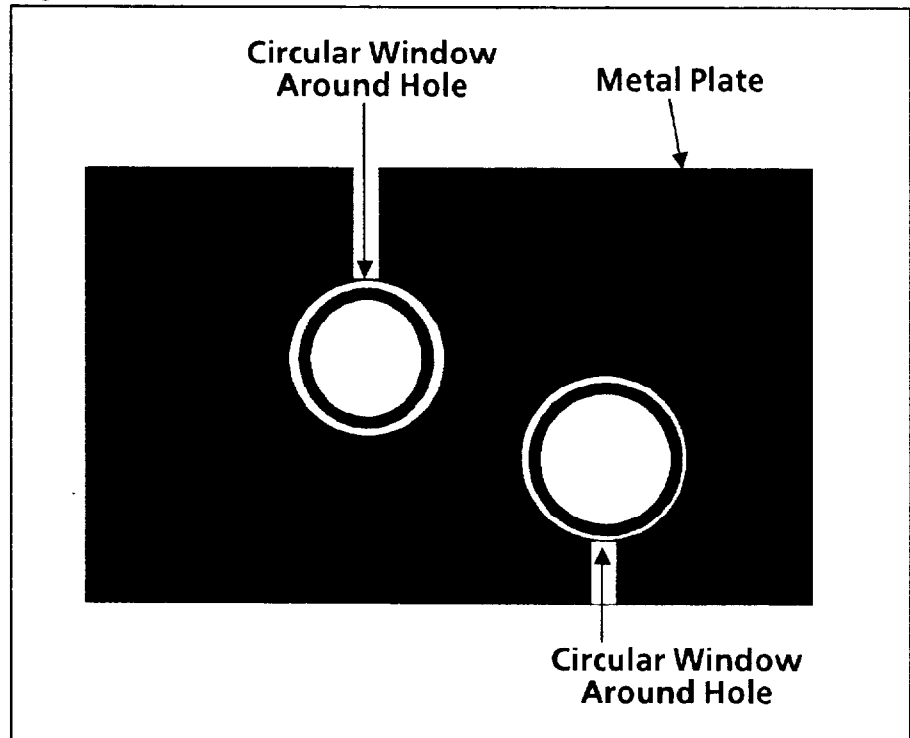

The windows' function in this example is simply to *count the white pixels* within their boundaries.

By counting white pixels, the windows are, in effect, measuring the *area* of the holes. Thus, if a hole is missing, incompletely punched, or undersize, the area of the hole— the number of white pixels — will be *smaller* than expected. If the hole is too large, the area will be *greater* than expected.

In each case, the CVIM system will issue a "pass/fail" signal.

Using Elliptical Windows (continued)

Example 2: This example uses circular windows to determine whether an O-ring is present or missing, or is improperly installed, on the inside wall of a cylinder. The assumptions are these:

- The open end of the cylinder is frontlighted.
- The CVIM system will use *one* circular window to count the black pixels from the O-ring.
- Shift and rotation compensation will *not* be used. (For information on shift compensation, see Chapter 6, *Reference Tools: Lines and Windows.*)

The objective for the CVIM system in this example is to inspect every cylinder for the presence of a properly installed O-ring.

The CVIM system will issue a “pass/fail” signal for all cylinders with missing or improperly installed O-rings.

Figure 8.5 shows how the open end of the cylinder might look on your monitor screen. It would most likely appear gray when lighted from above. The inside of the cylinder might appear as darker shades of gray because of shadows.

Figure 8.5 Looking Into Open End of Cylinder With and Without O-Ring

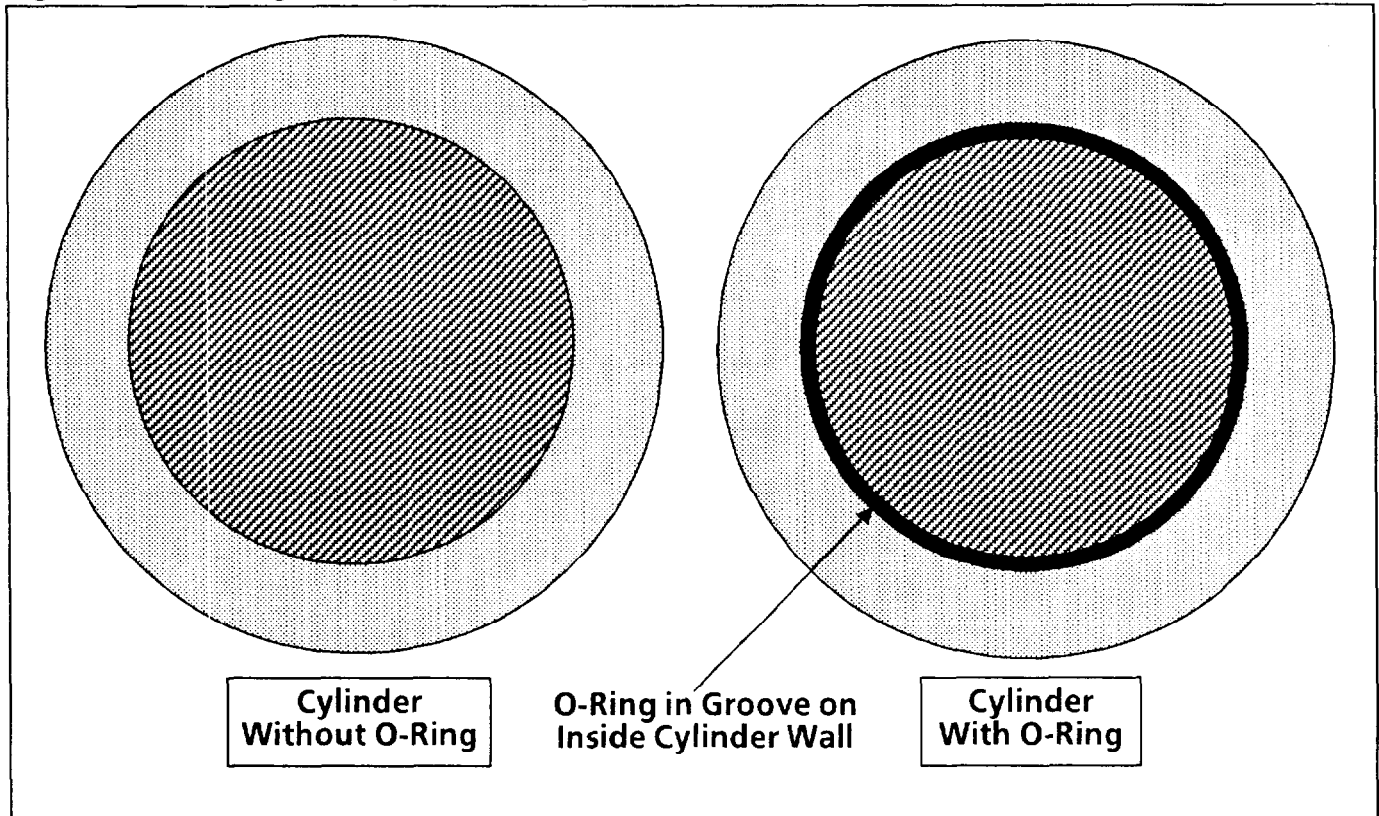

The O-ring is installed in a groove on the inside wall of the cylinder, and it is easily visible when viewed from the open end.

Using Elliptical Windows (continued)

Figure 8.6 shows how a circular window might appear when it is positioned over the end of the cylinder. In this example, the window's diameter needs to be just large enough to enclose the O-ring. This allows for a small amount of cylinder shift along its X and Y axes of the image on the monitor screen.

Figure 8.6 Circular Window Positioned Over End of Cylinder

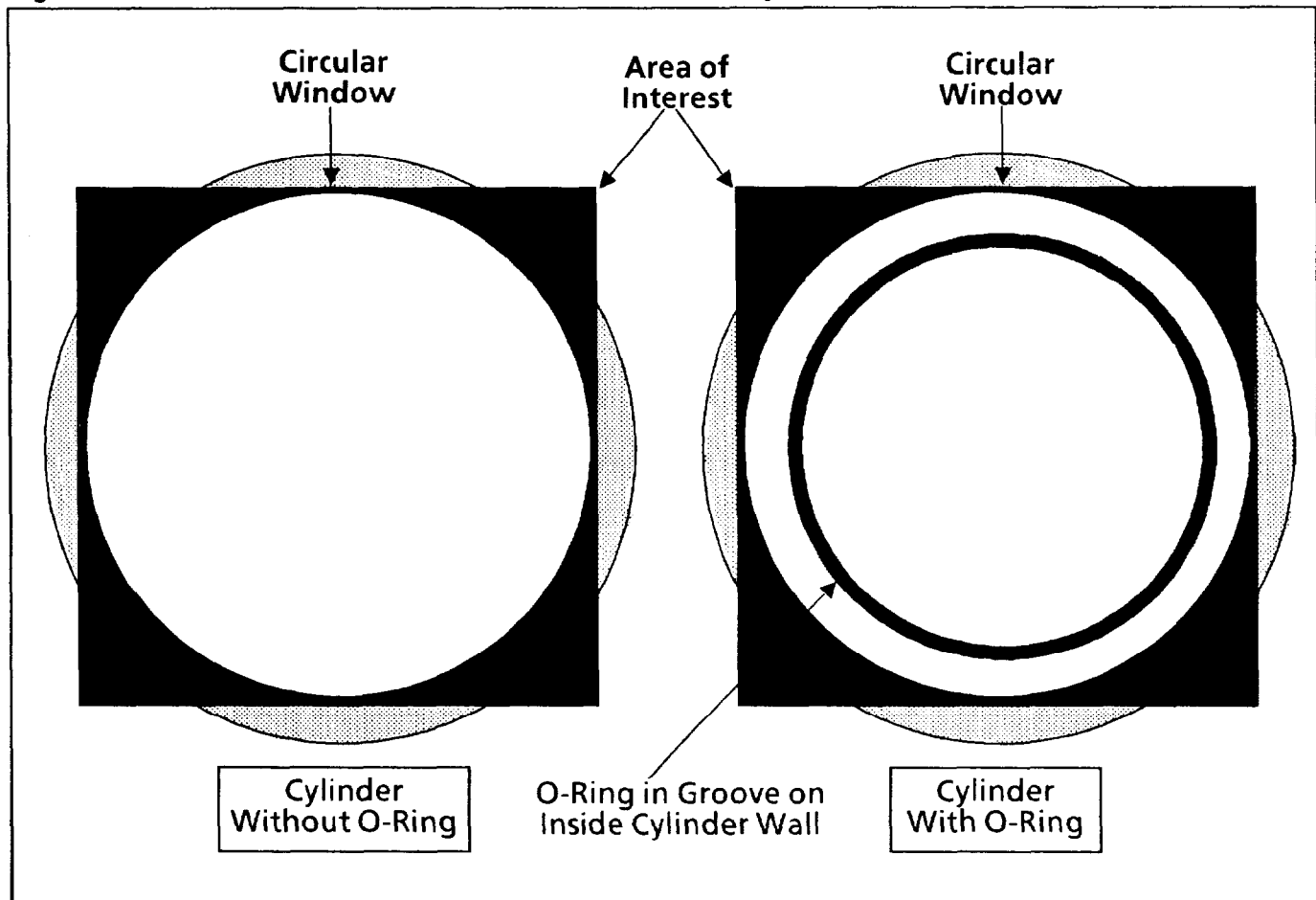

The window is shown as a white circle inside a black square. The black square is called the "area of interest"; however, the circle is the *only* part of the image that the window will evaluate.

The function of the window in this example is simply to count the black pixels in the O-ring. When the O-ring is *present*, the black pixel count might be 1000 to 1500; when the O-ring is *missing*, the pixel count will be 0.

If an O-ring were not properly seated in the groove, the window would probably detect that because it might see *too many* black pixels.

In any case, the CVIM system will issue a "pass/fail" signal whenever the black pixel count is beyond the specified range limits.

Using Masks With Windows

Within each inspection window, a second window is available that you can configure to cover unwanted or unneeded parts of the workpiece image. This second window is called a "mask."

In some window applications, only a small part of the image within the inspection window may be needed. In other applications, some part of the image within the inspection window may need "masking" because visual "noise" in it interferes with the inspection of a particular workpiece feature.

During an inspection operation, the window ignores the image area *within* the mask. It processes *only* the area *outside* the mask, but *inside* the window's boundaries.

Example: Refer to the elliptical window example in Figure 8.7. This example is similar to the one in Figure 8.6 except that it uses both a window *and* a mask.

Figure 8.7 Circular Window with Mask Positioned Over End of Cylinder

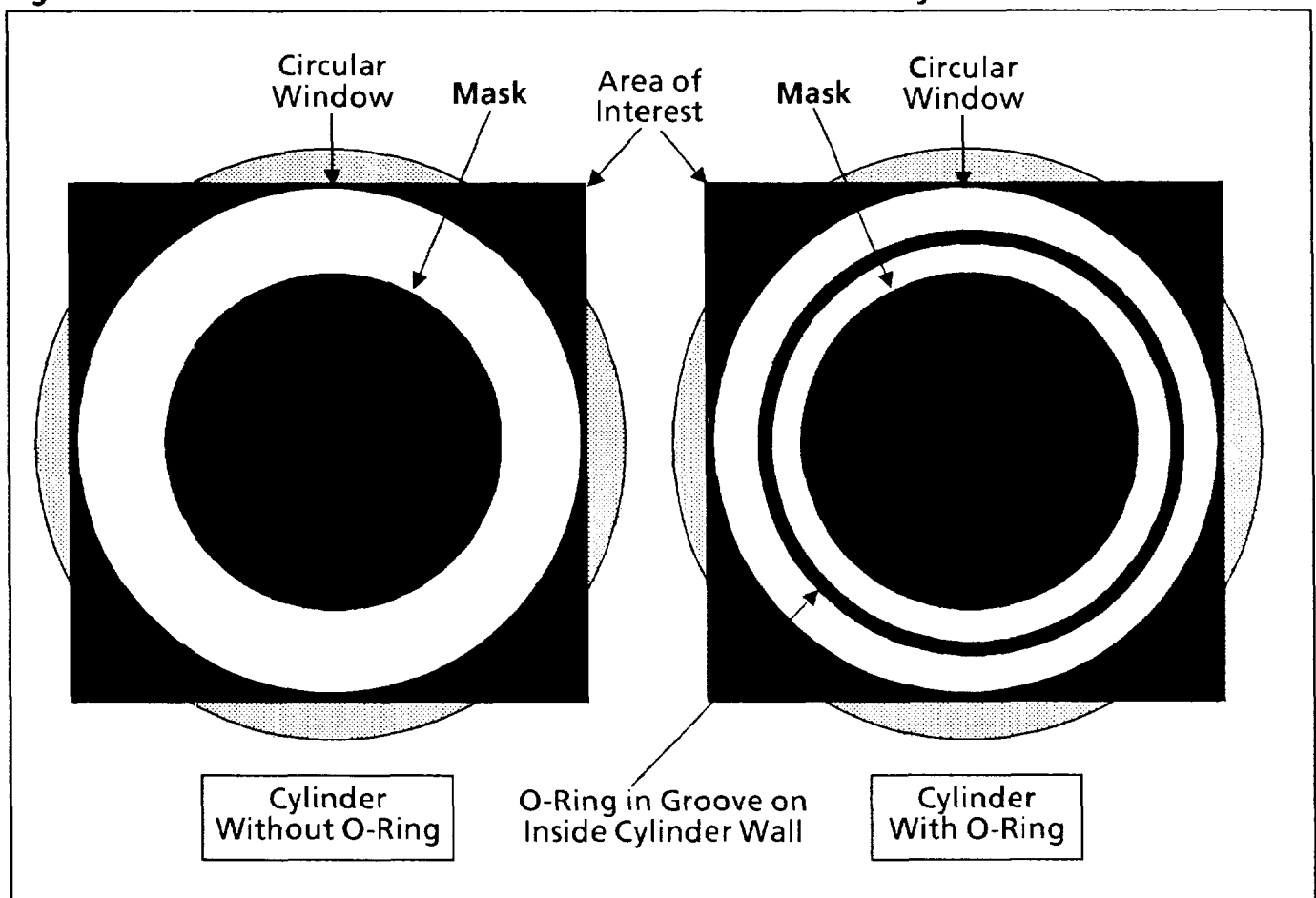

In this example, the mask and the window are both circular and are arranged concentrically over the cylinder and O-ring. The practical value in using this mask is that it can remove visual "noise" or clutter that may interfere with the inspection; however, a mask will increase processing time.

Using Polygonal Windows

This section describes how you can use *polygonal* windows to inspect a workpiece or parts of a workpiece.

The main advantage of using a polygonal window is that you can tailor it to fit an odd-shaped workpiece or part of a workpiece. In either case, the polygonal window can *exclude* areas that may interfere with the inspection process.

Here are the capabilities and limitations of polygonal windows:

- Four polygon windows are available per tool set.
- A polygonal window can have from three to sixteen sides.
- A mask cannot be used with a polygonal window.

Example: This example uses a polygonal window to inspect three screws on a workpiece. The six-sided, L-shaped window will look *only* at the area including the three screws. It thus avoids the “clutter” on the workpiece.

Figure 8.8 Polygonal Window Around Screws in Workpiece

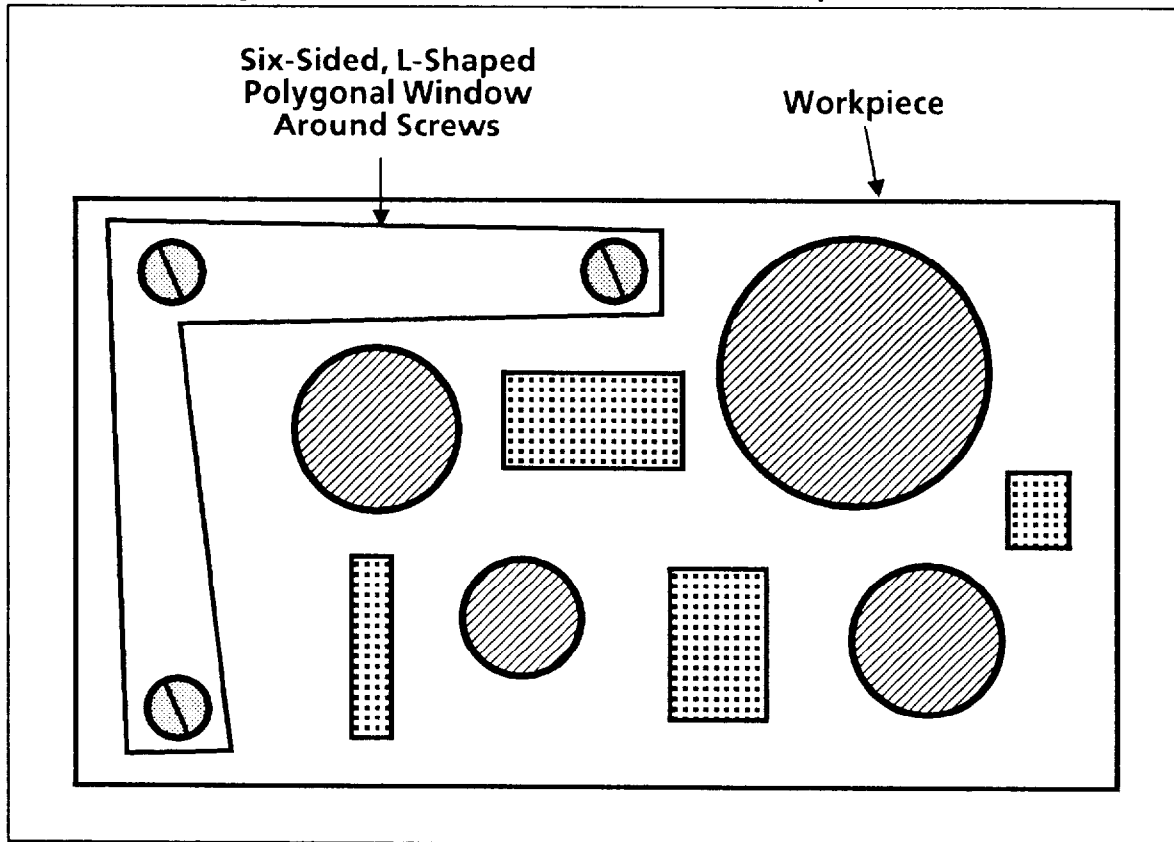

The polygonal window's function could be to count objects (the screws) or count black pixels (the total area of the screws). Regardless of which inspection method is used, if a screw is missing, either the object count will be short or the area will be too small.

In each case, the CVIM system will issue a “pass/fail” signal.

Configuring Windows

In configuring windows you will select the configuration categories in the Window popup menu, which appears when you pick Window from the Main Configuration menu.

These are the main configuration categories in the Window popup menu:

- **Window definition:** Sets the window position and shape, and selects the window's inspection function (the window "operation").
- **Select range limits, output lines, reference tool:** Selects the operating range limits that determine a "pass" or "fail" result; selects the output line for reporting inspection results; selects a reference tool from which the window can receive shift compensation.
- **Learn window measurements:** This function "learns" the current window measurement *value*, which varies according to the type of window operation selected.
- **Select window number:** This function selects the window number (1 to 24).
- **Enable/disable window:** This function enables or disables the currently selected window.

Configuring a window involves these basic steps:

- Selecting the window number (1 to 24).
- Enabling the selected window.
- Selecting the window shape: rectangular, elliptical, or polygonal.
- Selecting the window operation: count pixels, count objects, determine the average luminance, or perform a template match.
- Positioning and sizing the window(s) over the workpiece image.
- Selecting a mask, if needed.

The following pages show you how to perform all of the steps that configure windows. To save time, you should perform these steps in the order given.

**Selecting Window
Popup Menu**

Your first step is to select the Window popup menu.

Your Action

*Pick Window in the Main
Configuration menu.*

Comments

When you pick the Window menu box, the Window popup menu appears above the Main Configuration menu, as follows:

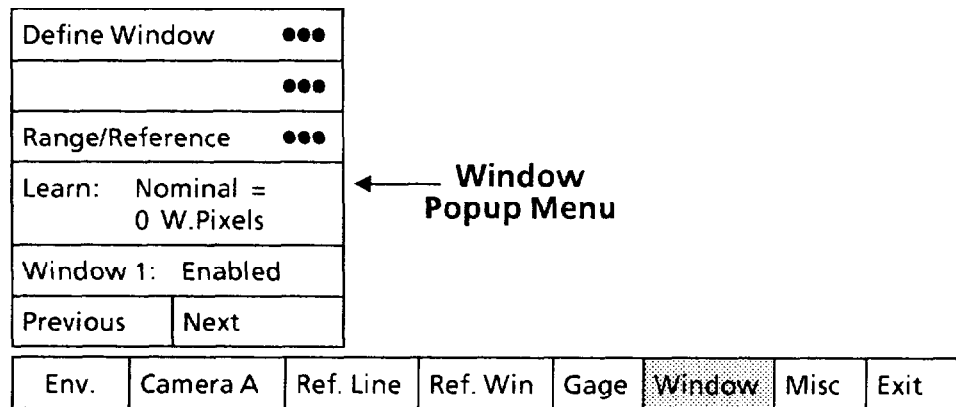

The Window popup menu shows the five configuration categories described earlier.

In addition to the Window popup menu, if the currently selected window is *enabled*, as shown above, it will appear somewhere on the monitor screen.

**Selecting and Enabling
Window**

Select the window number and enable the window.

Your Action

*Look at the Window menu
box in the Window
popup menu.*

Comments

The Window menu box indicates the currently selected window number (1 to 24). The menu box indicates whether that window is Enabled or Disabled.

Select the window number.

To change the window number, pick the Next (or Previous) menu box repeatedly until the correct number appears.

The Next and Previous functions work like this: When you pick the Next box, the next *higher* window number appears: 1, 2, 3, . . . 24, 1, 2, 3, and so on. When you pick the Previous box, the next *lower* window number appears: 3, 2, 1, 24, . . . 3, 2, 1, and so on.

*Look at the Window
menu box again.*

If Disabled, appears, perform the next step.

*Pick the Window
menu box.*

To *enable* the window, pick the Window menu box. The box should now indicate Enabled.

**Selecting Define Window
Popup Menu and
Parameters**

Select the Define Window popup menu, then select the parameters in that menu.

Your Action

Comments

Pick the Define Window menu box in the Window popup menu.

When you pick the Define Window menu box, the Define Window popup menu appears above the Window popup menu, as follows:

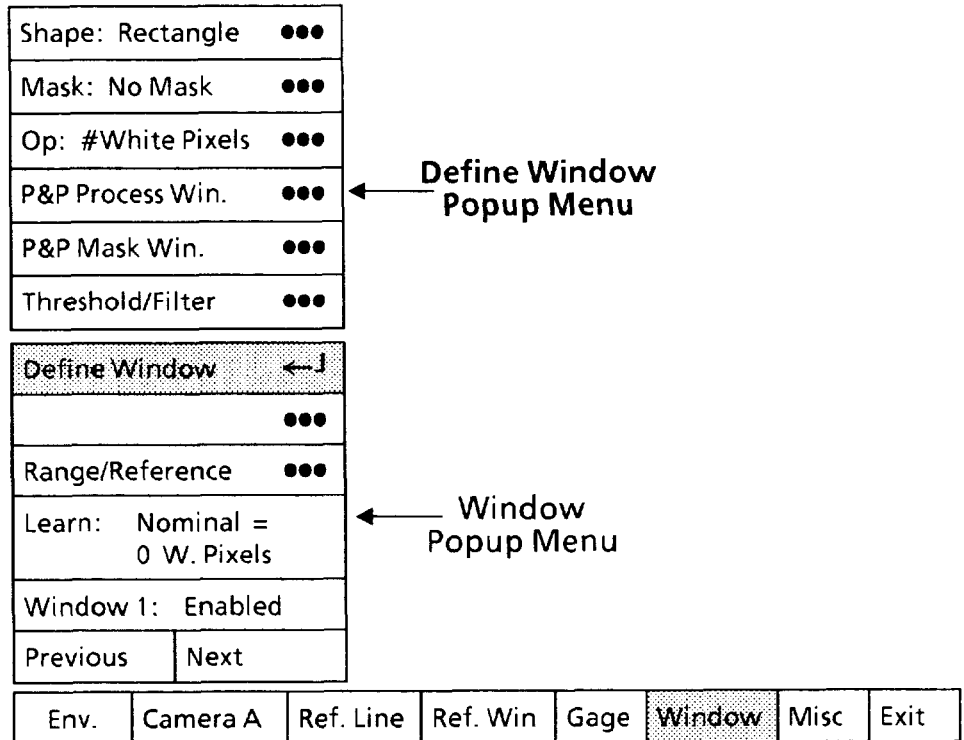

Selecting Window Shape

Pick the Shape menu box to select a *rectangular*, *elliptical*, or *polygonal* window, whichever is appropriate for your application.

Your choice of window shape depends on the *shape* of the workpiece or workpiece part that you want the window to inspect. Note that the rectangular window is the most *efficient*.

Your Action

Comments

Look at the Shape menu box in the Define Gage popup menu.

The Shape menu box shows whether the currently selected window is Rectangular, Elliptical, or Polygonal.

**Selecting Define Window
Popup Menu and
Parameters (continued)**

Selecting Window Shape (continued)

Your Action

*Pick the Shape menu box,
if appropriate, to select
the Window Shape
popup menu.*

Comments

When you pick the menu box, the Window Shape popup menu will appear alongside the Define Window menu.

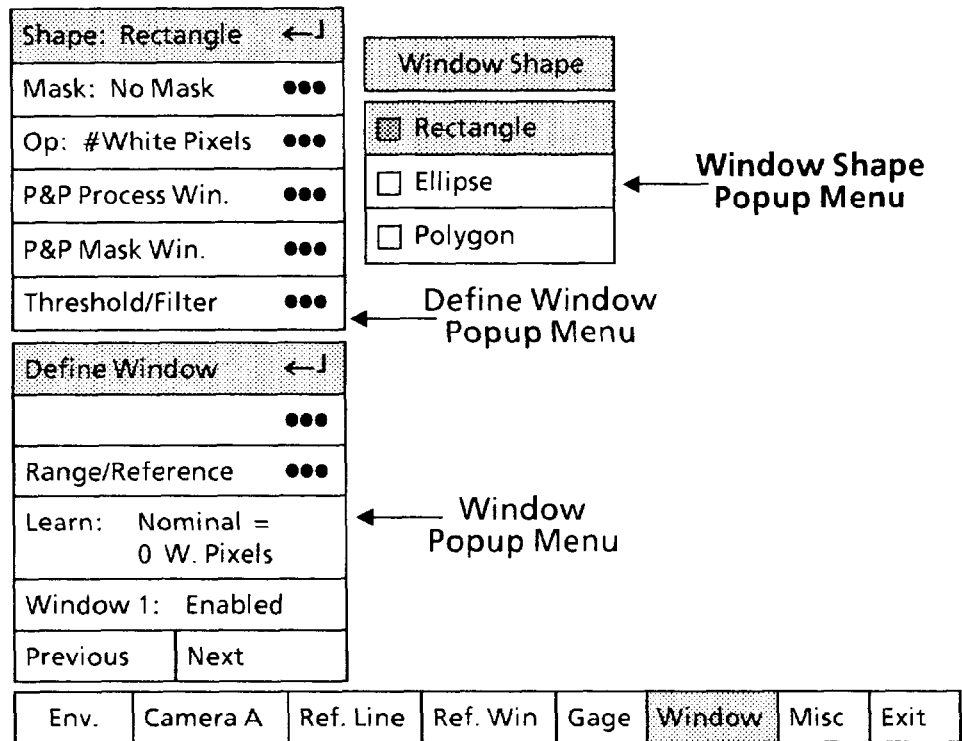

Note that the Rectangle box in the Window Shape popup menu has a shaded square (◻). This indicates that the window is currently configured as a rectangle.

*Pick the appropriate shape
from the Window Shape
menu box.*

When you pick a *different* window shape menu box, the new selection will be highlighted in the Window Shape popup menu and will appear in the Shape menu box.

Also, the new window shape will appear on the monitor screen.

Selecting Define Window Popup Menu and Parameters (continued)

Using P&P Process Win. Function

Pick the P&P Process Win. menu box, then position the window over the workpiece and set the window's dimensions. ("P&P" means "pick and place.")

The following procedure is based on an example that shows you how to manipulate a *rectangular* (or *elliptical*) window with the light pen. A subsequent example shows how to manipulate a *polygonal* window and increase or decrease the number of sides.

Each example includes these basic steps:

- Positioning the window over the workpiece.
- Setting the window to the appropriate dimensions.

The example in the next several steps configures a *rectangular* window over a rectangular workpiece, starting with the small square window below. (You can use the same steps to configure an *elliptical* window.)

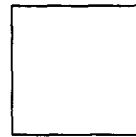

Use the following steps to position the window and set its length.

Your Action

Pick the P&P Process Win. menu box in the Define Window popup menu.

Comments

When you pick the P&P Process Win. menu box, a small square (□) will appear in the center of the currently selected window and in the center of each side of that window, as follows:

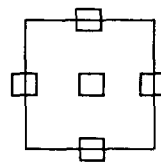

These squares are the "handles" that the light pen uses to manipulate the window on the monitor screen.

Aim the light pen at the center handle.

Aim the light pen at the center handle until the light pen "sees" the handle. You may have to move the light pen around slightly.

When the light pen sees the handle, a larger "highlight" square will surround the handle, as follows:

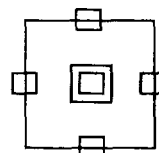

**Selecting Define Window
Popup Menu and
Parameters (continued)**

Using P&P Process Win. Function (continued)

Your Action

Comments

Pick the handle.

Hold the pen steady in this position – the appearance of the highlight square means that the light pen is now properly aimed.

Drag the window to the center of the workpiece.

You can now "drag" the window across the monitor screen. When you move the pen, the entire window follows.

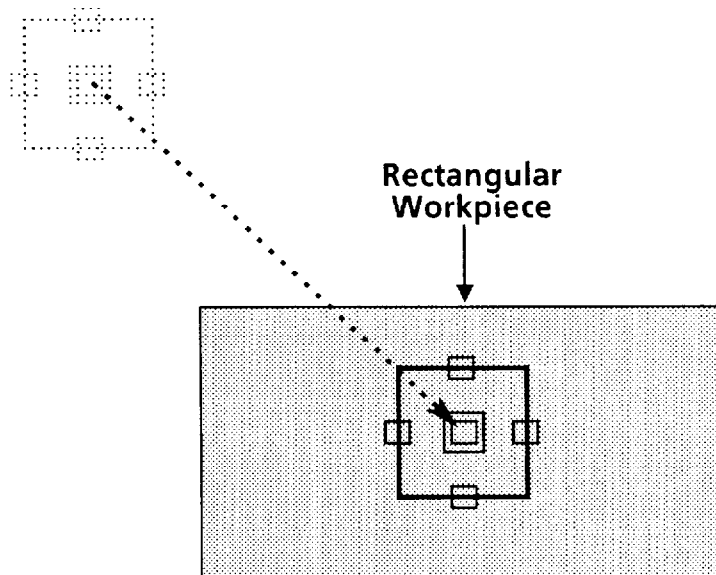

NOTE: Keep the tip of the pen within about one-half inch of the monitor screen.

When you have the window in position over the workpiece, press the pen against the monitor screen to "lock" the window at that position.

Aim the light pen at the rightmost handle.

Continue when the highlight square appears.

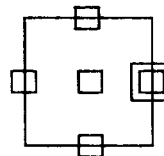

**Selecting Define Window
Popup Menu and
Parameters (continued)**

Using P&P Process Win. Function (continued)

Your Action

Comments

Pick the handle.

*Drag the right side until it is
just outside the workpiece.*

Note that the *left* side remains anchored.

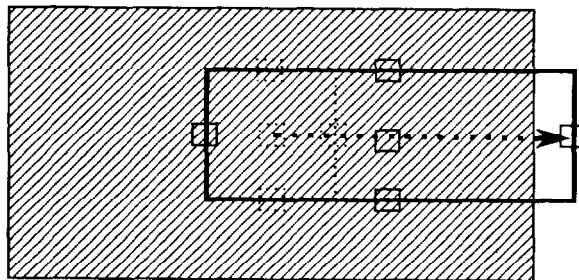

*Lock the window's right side
in position.*

*Aim the light pen at the
topmost handle.*

Continue when the highlight square appears.

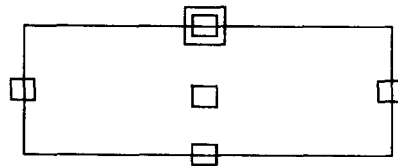

Pick the handle.

*Drag the top side until it is
just above the workpiece.*

Note that the *bottom* side remains anchored.

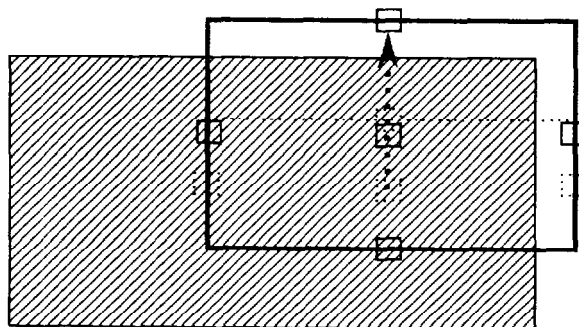

*Lock the window's top side
in position.*

**Selecting Define Window
Popup Menu and
Parameters (continued)**

Using P&P Process Win. Function (continued)

Your Action

Comments

Repeat this process for the left and bottom sides.

Drag the *left* side and *bottom* sides until the window looks like this:

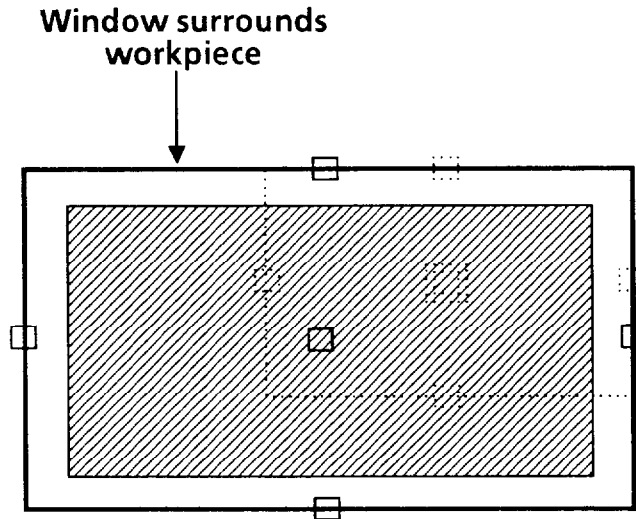

At this point, you have adjusted the window's position and size so that, during an inspection, it will be able to inspect the entire workpiece.

To manipulate a polygon window and increase or decrease the number of sides on a polygonal window, continue with the following procedures.

If you select a *polygon* window shape, the Mode popup menu will appear in the lower-right corner of the monitor screen when you pick the P&P Process Win. menu box:

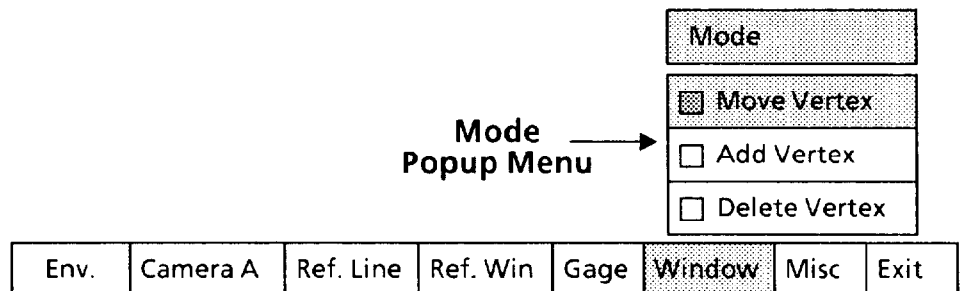

Note that the Move Vertex box in the Mode popup menu has a shaded square (☑). This indicates that the menu is currently configured for *moving* the polygon and its vertices.

**Selecting Define Window
Popup Menu and
Parameters (continued)**

Using P&P Process Win. Function (continued)

These are the three configuration modes in the Mode popup menu:

The Move Vertex menu box enables you to move the polygon and its vertices anywhere on the screen. When you pick the P&P Process Win. menu box, the CVIM system automatically "picks" the Move Vertex menu box.

The Add Vertex menu box enables you to add *vertices* to the current polygon. The effect is to add *sides* to the polygon. The *maximum* number of sides is sixteen.

The Delete Vertex menu box enables you to subtract *vertices* from the current polygon. The effect is to subtract *sides* from the polygon. The *minimum* number of sides is three.

The following steps use a simple example – a four-sided polygon in the shape of a *diamond* – to show the effect of using the Move Vertex functions.

Initially, the handles are located at the four vertices and center of the polygon:

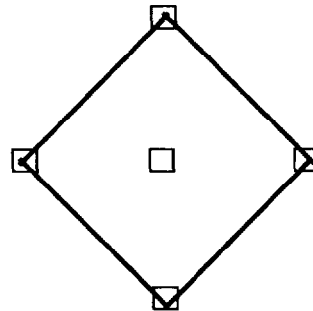

Your Action

*Aim the light pen at the
center handle.*

Comments

Continue when the highlight square appears.

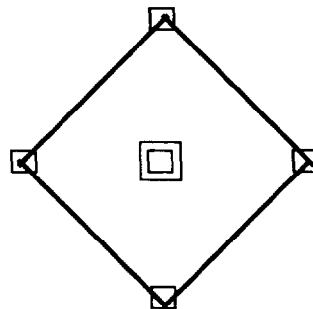

Pick the handle.

**Selecting Define Window
Popup Menu and
Parameters (continued)**

Using P&P Process Win. Function (continued)

Your Action

*Drag the entire polygon
to the left, as shown.*

Comments

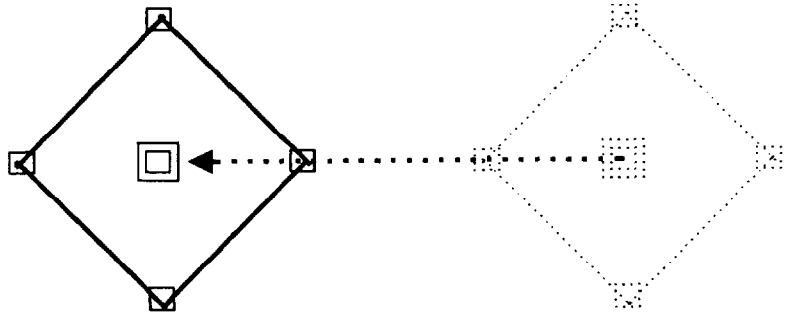

*Aim the light pen at the
rightmost vertex handle.*

Continue when the highlight square appears.

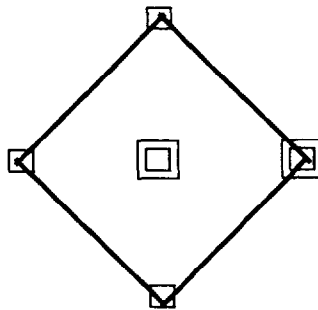

*Pick the vertex handle.
Drag the rightmost vertex
to the right, as shown.*

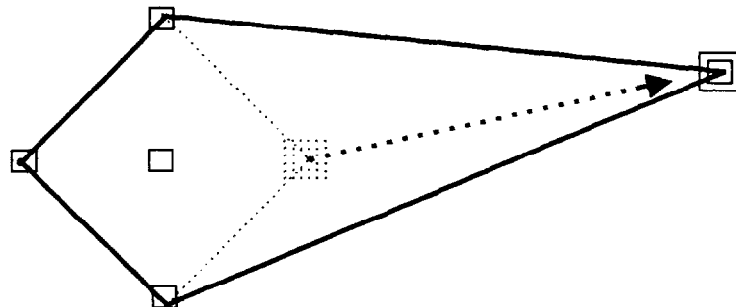

**Selecting Define Window
Popup Menu and
Parameters (continued)**

Using P&P Process Win. Function (continued)

Your Action

*Aim the light pen at the
topmost vertex handle.*

Comments

Continue when the highlight square appears.

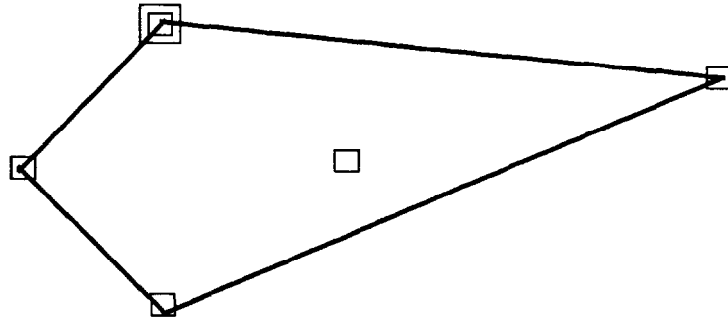

Pick the vertex handle.

*Drag the topmost vertex down
and to the right, as shown.*

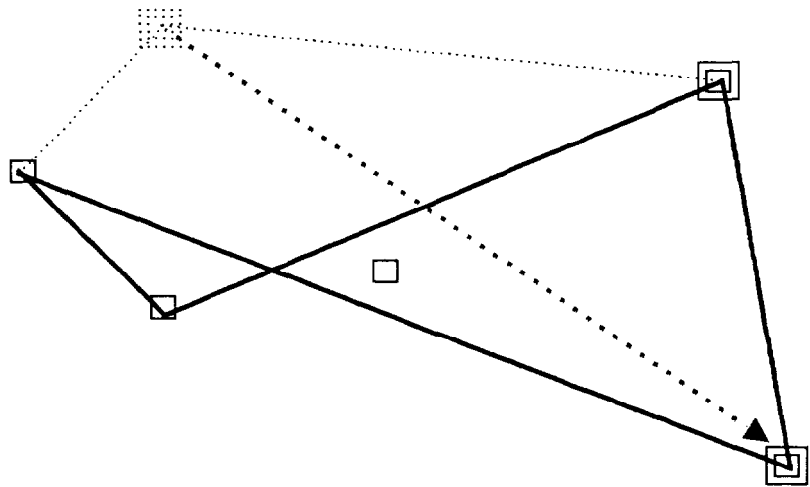

The polygon now has *two* enclosed areas. As noted earlier, you can move a vertex *anywhere* on the screen. This includes moving it across an adjacent or opposite side of the polygon.

**Selecting Define Window
Popup Menu and
Parameters (continued)**

Using P&P Process Win. Function (continued)

Your Action

Comments

The following steps use a simple example – a four-sided polygon in the shape of a *rectangle* – to show the effect of using the Add Vertex and Delete Vertex functions.

Initially, the handles are located at the vertices and center of the polygon:

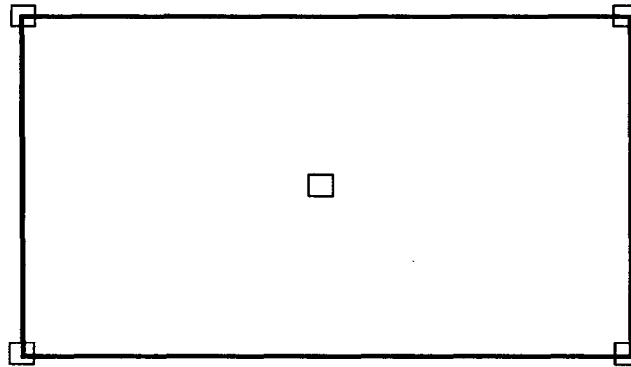

Your Action

*Pick the Add Vertex
menu box.*

Comments

When you pick the Add Vertex menu box, the menu box becomes shaded. The handles on the polygon *shift* from the vertices to the center of the sides, and the center handle disappears, as follows:

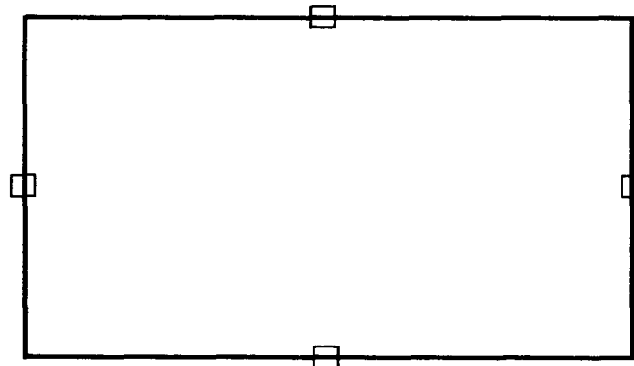

Mode →
Mode
Popup Menu

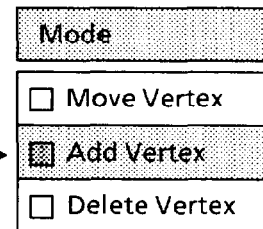

Env.	Camera A	Ref. Line	Ref. Win	Gage	Window	Misc	Exit
------	----------	-----------	----------	------	--------	------	------

**Selecting Define Window
Popup Menu and
Parameters (continued)**

Using P&P Process Win. Function (continued)

Your Action

Comments

*Aim the light pen at the
leftmost handle.*

Continue when the highlight square appears.

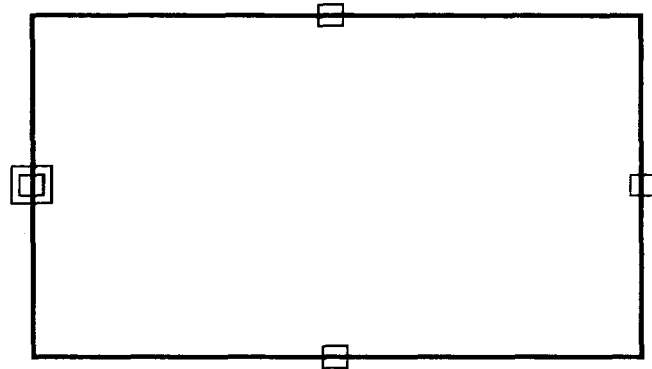

*Pick the handle.
Drag the new vertex to the
left, as shown.*

The rest of the polygon will remain anchored.

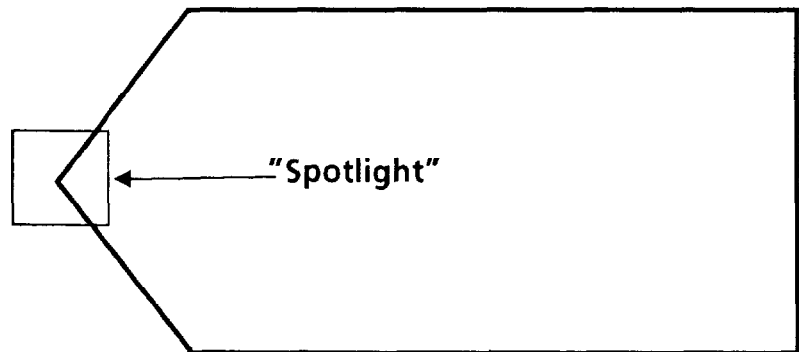

Lock the vertex in position.

The vertex will follow the light pen wherever you move it. Note that the previous left side has become *two* sides – the polygon now has *five* sides – and a new handle appears in the center of *each* of these two sides.

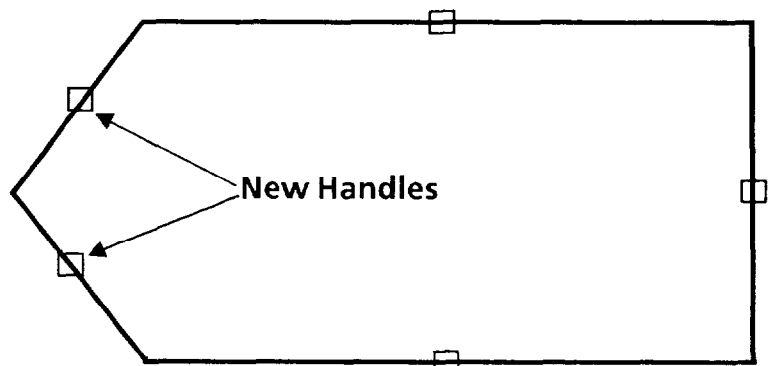

**Selecting Define Window
Popup Menu and
Parameters (continued)**

Using P&P Process Win. Function (continued)

Your Action

Comments

To exit the Add Vertex function, pick the Add Vertex menu box again.

Pick the Delete Vertex menu box.

You can repeat the Add Vertex "pick and place" function until the polygon has 16 sides.

When you pick the Add Vertex menu box, the shading is removed, and all handles (except the center handle) return to the polygon vertices.

When you pick the Delete Vertex menu box, the menu box becomes shaded. Handles remain at the vertices, but the center handle disappears, as follows:

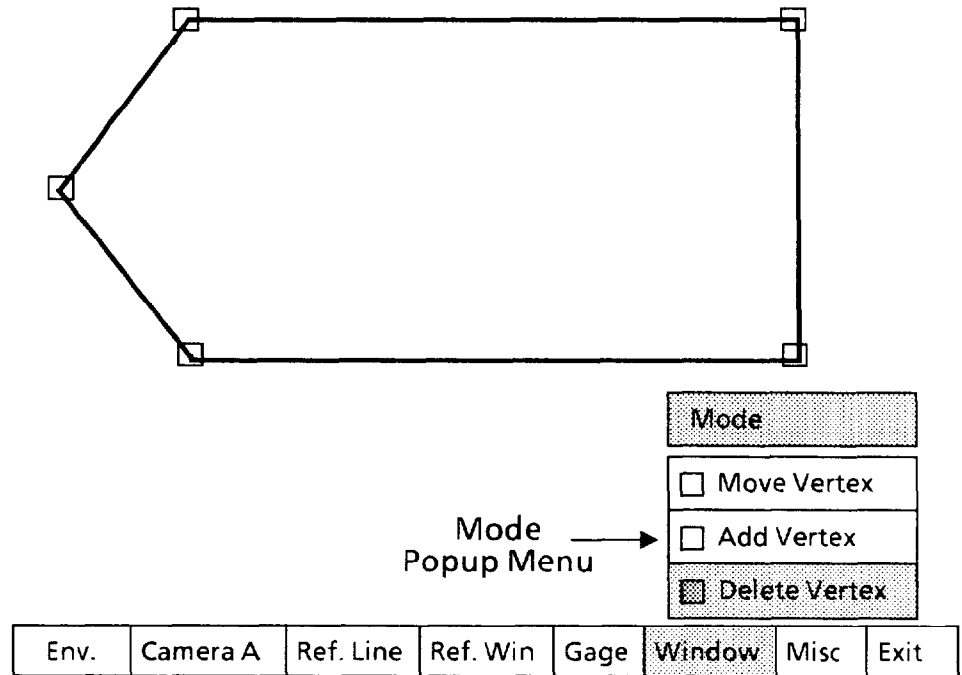

Aim the light pen at the leftmost vertex.

Continue when the highlight square appears.

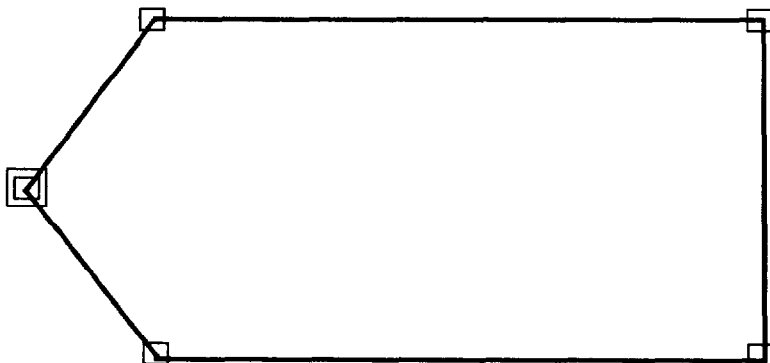

**Selecting Define Window
Popup Menu and
Parameters (continued)**

Using P&P Process Win. Function (continued)

Your Action

Pick the handle.

Comments

When you pick the handle, the two leftmost sides become one again, as follows:

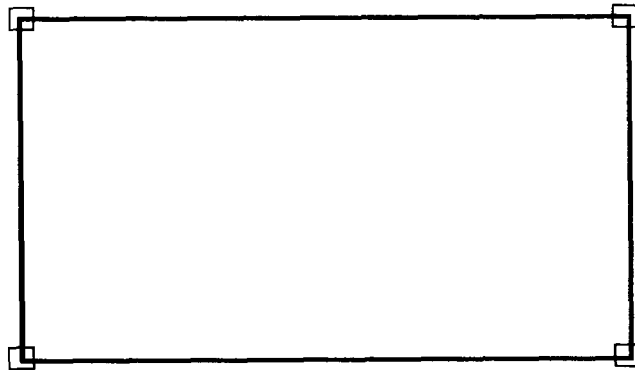

You can repeat the Delete Vertex "pick and place" function until the polygon has only three sides.

If necessary, use the vernier arrows to "fine-tune" the position or size of the window.

You can change the window's size or position more *precisely* by using the *vernier* arrows. The vernier arrows enable you to make these changes in small increments.

You can access the vernier arrows while either *picking* a window handle or *placing* the window or window side.

Press and hold the light pen tip against the window handle, window, or window side.

Hold the light pen tip in for about *one second*. The vernier arrows will then appear in the lower-right corner of the monitor screen:

VERNIER ARROWS

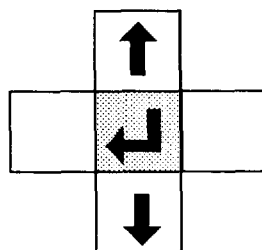

Move top or bottom side up or down.

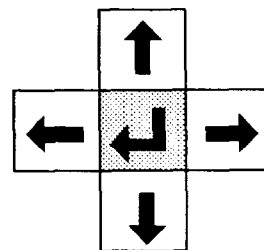

Move vertex or entire window up, down, left, or right

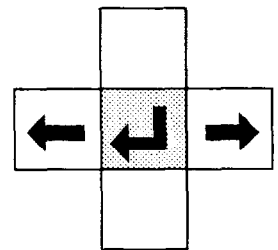

Move left or right side left or right.

Selecting Define Window Popup Menu and Parameters (continued)

Using P&P Process Win. Function (continued)

Your Action

Pick an arrow once to move the window or window side one pixel in the arrow's direction.

Pick and hold an arrow to change the window size or position continuously.

Pick the "return" symbol to release the vernier arrows.

Comments

The up, down, right, or left arrow, will move the entire window or window side (*vertex* for polygons) *one pixel* in the direction indicated by the arrow.

When you pick and *hold* an arrow, the window's size or position will change slowly for the first five or six increments. It will then change at a more rapid rate.

When the window's size and/or position are correct, pick the "return" symbol (←J) to *release* the vernier arrows and return to the pick-and-place mode.

Selecting Window Mask Popup Menu

If a mask is appropriate for your application, select a *rectangular* or *elliptical* mask. Otherwise, select No Mask if no mask is needed for your application.

Your choice of mask shape depends on the shape of the workpiece image area that you want masked.

NOTE: Here are a few things about masks to keep in mind:

- You can use *any* mask shape with *any* window shape except a polygon.
- You cannot use a mask when using a window for template matching.
- You can position a mask *anywhere* in relation to its associated window, even totally *outside* the window. (The mask, in this case, would not be able to mask anything.)
- You can make the mask large enough to *include* the window. (The window, in this case, would be completely masked.)
- Using a mask will increase processing time.

Your Action

Look at the Mask menu box in the Define Window popup menu.

Comments

The Mask menu box shows whether a mask is currently selected, and, if so, whether that mask is a Rectangle or Ellipse. If the current shape is *not* the one you want, continue with the next steps.

**Selecting Define Window
Popup Menu and
Parameters (continued)**

Selecting Window Mask Popup Menu (continued)

Your Action

Comments

*Pick the Mask menu box,
if appropriate.*

When you pick the Mask menu box, the Window Mask popup menu will appear, as follows:

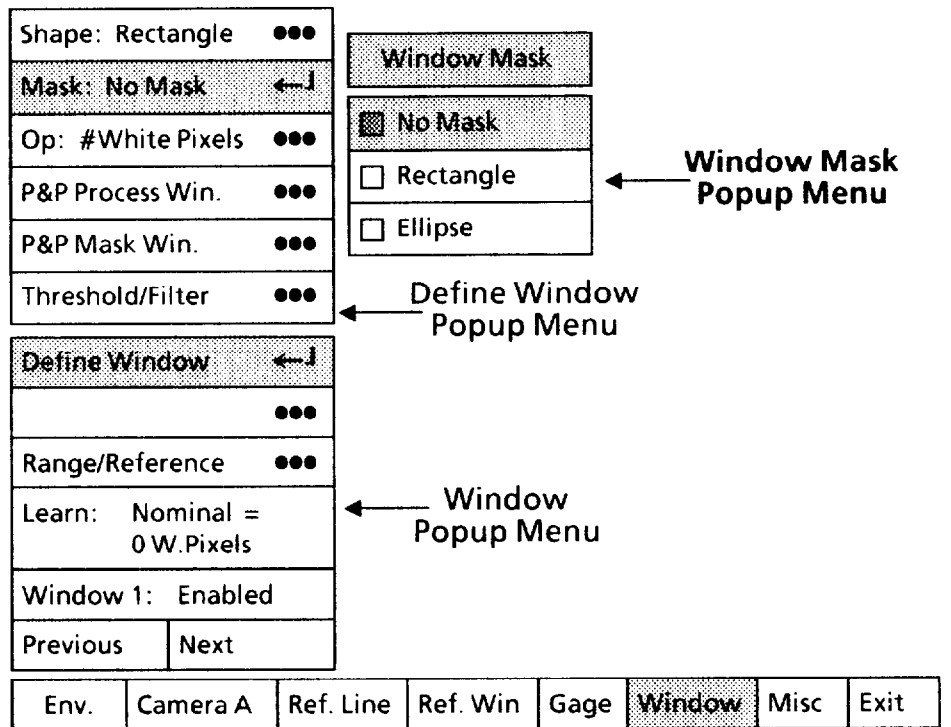

Note that the No Mask box in the Window Mask popup menu has a shaded square (☐). This indicates that no mask is currently selected for this window.

*Pick the appropriate
mask shape from the
Window Mask menu.*

If you pick a *different* Window Mask menu box, it will appear as in the Mask menu box. In addition, the new mask shape (or no mask) will appear on the monitor screen.

Using P&P Mask Win. Function

Pick the P&P Mask Win. menu box, then position the mask within the window as is appropriate for your application and set the mask's dimensions.

Refer to *Using P&P Process Win. Function* for instructions on positioning and sizing the mask window. The procedure for manipulating mask windows is *identical* to the procedure for manipulating process windows.

Selecting Define Window Popup Menu and Parameters (continued)

Selecting Window Operation Popup Menu

Pick the Op menu box, then select one of six operations for an elliptical or polygonal window, or seven operations for a rectangular window, as follows:

1. Count the number of *white pixels* inside the window.
2. Count the number of *black pixels* inside the window (see the NOTE, below).
3. Count the number of *white objects* inside the window.
4. Count the number of *black objects* inside the window.
5. Locate the edge *gradient* between black and white areas within the window, identify the gradient with thin band of white pixels, and count the number of white pixels in the gradient "band."
6. Measure the *average luminance* of all pixels inside the window.
7. Perform a "template" match by comparing a designated area on the workpiece (the "template") with the *same* area on all workpieces to be inspected. Note that this operation can be used *only* with a *rectangular window with no mask*.

Your choice of window operation depends on which one is appropriate for your application.

NOTE: Windows that are tied to reference windows can rotate. The total number of pixels contained in a rotated window can be slightly greater than or less than the total number of pixels in the original unrotated window. You will need to account for this condition when you set the "pass/fail" limits.

The CVIM system performs the white pixel count operation by counting the number of white pixels within the window in its present orientation. The value reported for the black pixel count operation is equal to the total number of pixels in the original unrotated window minus the number of white pixels counted within the window in its present orientation.

This slight change in window size is normally insignificant; however, for some applications, such as inspecting a white area for small black defects, it may be desirable to *invert* the image within the window, using the threshold cursors, then select the #White Pixels window operation. Another alternative is to use the #Black Objects window operation instead of the #Black Pixels operation.

Your Action

Look at the Op menu box in the Define Window popup menu.

Comments

The Op indicates the currently selected window operation. If that is *not* the operation you want, continue with the next steps and select a different operation.

**Selecting Define Window
Popup Menu and
Parameters (continued)**

Selecting Window Operation Popup Menu (continued)

Your Action

Pick the Op menu box.

Comments

When you pick the Op menu box, the Window Operation popup menu should appear, as follows:

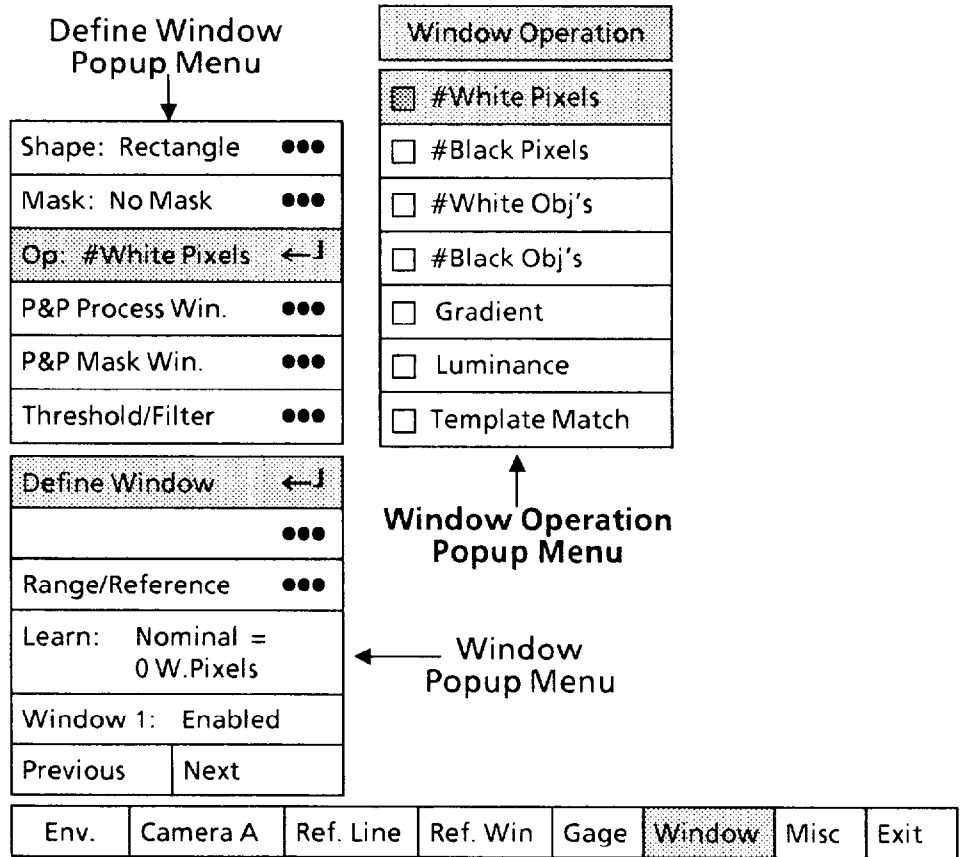

Note that the #White Pixels box in the Window Operation popup menu has a shaded square (☑). This indicates that the window is currently configured to count the number of white pixels within its boundaries.

Pick the appropriate window operation from the Window Operation menu.

If you pick a *different* window operation menu box, a message will appear above the Window Operation menu, as follows:

WARNING: Selecting a new tool operation will result in the nominal, range, and statistical values being set to zero. Reselect to confirm.

The purpose of this message is to ask you to verify that you really want to change the tool operation. If so, pick the same menu box *again*.

**Selecting Define Window
Popup Menu and
Parameters (continued)**

Configuring #Obj's Operations

If you selected either the #White Obj's or the #Black Obj's menu box in the Window Operation popup menu, continue with the following steps. Otherwise, skip this section.

An "object" is any group of joined pixels: black pixels on a white background, or white pixels on a black background. The #Obj's operation enables a window to search for and count either black objects or white objects whose size lies within a specified range.

If a black object contains white pixels within its perimeter, the white pixels can either be counted as black pixels or they can be ignored. The same is true of a white object with black pixels inside its perimeter.

All objects, in order to be counted, must have a size (pixel count) that lies within a specified pixel range, or "tolerance," which is based on the pixel count of a "target" object.

NOTE: To ensure correct counting, black objects must not touch the window boundary.

In the following steps, assume that you have already selected the #Black Obj's operation. Use these steps to specify the target object and set the object-size range limits for your object-counting application.

Your Action	Comments
<i>Pick the Define Target menu box.</i>	When you pick the Define Target menu box, the Define Target popup menu will appear, as follows:

Selected Target Area = 0		
+ White to Area		
'Pick' Target	●●●	← Define Target Popup Menu
+ Tolerance: 10000	●●●	
- Tolerance: 0	●●●	
Define Window		
Define Target		← Define Target Menu Box
Range/Reference		
Learn: Nominal = 0 B. Objects		← Window Popup Menu
Window 1: Enabled		
Previous	Next	

Env.	Camera A	Ref. Line	Ref. Win	Gage	Window	Misc	Exit
------	----------	-----------	----------	------	--------	------	------

**Selecting Define Window
Popup Menu and
Parameters (continued)**

Configuring #Obj's Operations (continued)

Your Action

Comments

Pick the 'Pick' Target menu box.

Earlier, when you picked the #White Obj's or #Black Obj's menu box, the Window popup menu acquired a "new" menu box – the Define Target menu box. This selects the Define Target popup menu, which you will use to define the "target" object and set the parameters for the objects to be counted.

When you pick the 'Pick' Target menu box, a green outline will appear around one of the objects within the window, as follows:

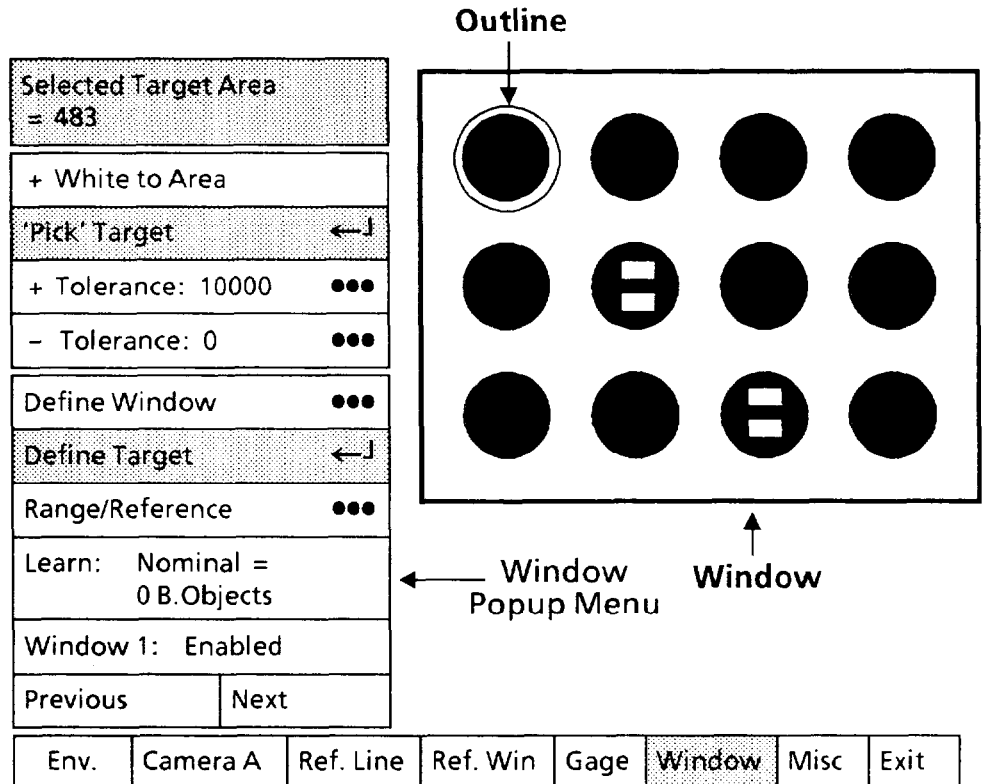

Look at the outlined object.

If the outlined object is *not* the one that you want to use as the "target" object, perform the next two steps.

Aim the light pen at the appropriate "target" object.

Aim the light pen at the whichever object you have selected as the "target" object. When the light pen "sees" the new object, a red outline will appear around that object.

Pick the new "target" object.

When you pick the new target object, a green outline will replace the red outline around it, and the green outline around the *previous* target object will disappear.

Note that the top box indicates the "area" of the target object: Selected Target Area = 483. This is the number of black pixels in the target object.

**Selecting Define Window
Popup Menu and
Parameters (continued)**

Configuring #Obj's Operations (continued)

Your Action

Comments

Look at the menu box just above the 'Pick' Target box.

This menu box will display either + White to Area or - White from Area, according to how it was last configured. (If you had selected the #White Obj's operation, the menu box would display either + Black to Area or - Black from Area.)

If you select + White to Area, the window will *add* any white pixels within an objects's boundary and will consider an object to be solid black. Thus, an object's *size* will consist of *all* of the pixels within its boundary.

If you select - White from Area, the window will *subtract* the white pixels from the total number of pixels within an object's boundary. Thus, an object's *area* will consist of *all* of the pixels within its boundary *minus* the white pixels.

The same process applies when you select the #White Obj's operation.

If this function is *not* currently set the way you want it, perform the next step. Otherwise, skip the next step.

If appropriate, pick the "... Area" menu box.

When you pick the "... Area" menu box, the *current* status toggles to the *opposite* status. Thus, + White to Area will change to - White from Area, or vice versa.

Pick the + Tolerance: menu box.

When you pick the + Tolerance: menu box, the "calculator pad" will appear on the monitor screen, as follows:

Selected Target Area = 0	
+ White to Area	
'Pick' Target	●●●
+ Tolerance: 10000	←↓
- Tolerance: 0	●●●
Define Window	●●●
Define Target	←↓
Range/Reference	●●●
Learn: Nominal = 0 B.Objects	
Window 1: Enabled	
Previous	Next
Env.	Camera A
Ref. Line	Ref. Win
Gage	Window
Misc	Exit

Calculator Pad

↓

10000					
7	8	9	+	-	%
4	5	6	X	/	=
1	2	3	←	Clr	
0	.		Enter		

**Selecting Define Window
Popup Menu and
Parameters (continued)**

Configuring #Obj's Operations (continued)

Your Action	Comments
Pick each digit of the new "+" tolerance limits.	<p>The + Tolerance value is the <i>upper</i> limit of the object's area, in pixels.</p> <p>As the calculator "display" indicates, the current value of + Tolerance is 10000. This is the <i>default</i> value for + Tolerance.</p> <p>The + Tolerance menu box enables you to select the <i>upper</i> limit of the tolerance range within which the area of the objects can deviate from area of the "target" object and still be counted.</p> <p>If the target object has an area of 483 black pixels, as shown in the preceding figure, you could set the + Tolerance to, say, 525. The window will then count objects having an area <i>no more than</i> 525 black pixels.</p>
Pick the Enter key.	The new value will appear in the + Tolerance menu box.
Pick the - Tolerance: menu box.	<p>The "calculator pad" will remain in its present position.</p> <p>The - Tolerance value is the <i>lower</i> limit of the object's area, in pixels.</p> <p>As the calculator "display" indicates, the current value of - Tolerance is 0. This is the <i>default</i> value for - Tolerance.</p> <p>The - Tolerance menu box enables you to select the <i>lower</i> limit of the tolerance range within which the area of the objects can deviate from area of the "target" object and still be counted.</p> <p>Again, if the target object has an area of 483 black pixels, as shown in the preceding figure, you could set the - Tolerance to, say, 450. The window will then count objects having an area <i>no less than</i> 450 black pixels.</p>
Pick each digit of the new "-" tolerance limits.	As you pick each digit, it will appear in the calculator "display." Thus, for a value of 450, pick "4," pick "5," then pick "0."
Pick the Enter key.	<p>The new value will appear in the - Tolerance menu box.</p> <p><i>You have now set the upper and lower range limits for the size of objects to be counted.</i></p>
	Skip the next steps and proceed to the section called <i>Selecting Range/Reference Popup Menu and Parameters</i> to configure the range limits, output lines, and reference tools, as appropriate for your application.

**Selecting Define Window
Popup Menu and
Parameters (continued)**

Using Threshold/Filter Function (Pixel and Object Counts)

Select the Pixel/Obj Filter popup menu and threshold-adjusting slide bar, then use a combination of filter selections and threshold settings to obtain the best *binary* image of the desired feature(s) within the window.

NOTE: The Threshold/Filter function applies *only* to these four window operations: #White Pixels, #Black Pixels, #White Obj's, and #Black Obj's.

Your Action

Comments

Pick the Threshold/Filter menu box in the Define Window popup menu.

When you pick the Threshold/Filter menu box, the Pixel/Obj Filter menu and slide bar appear on the monitor screen, as follows:

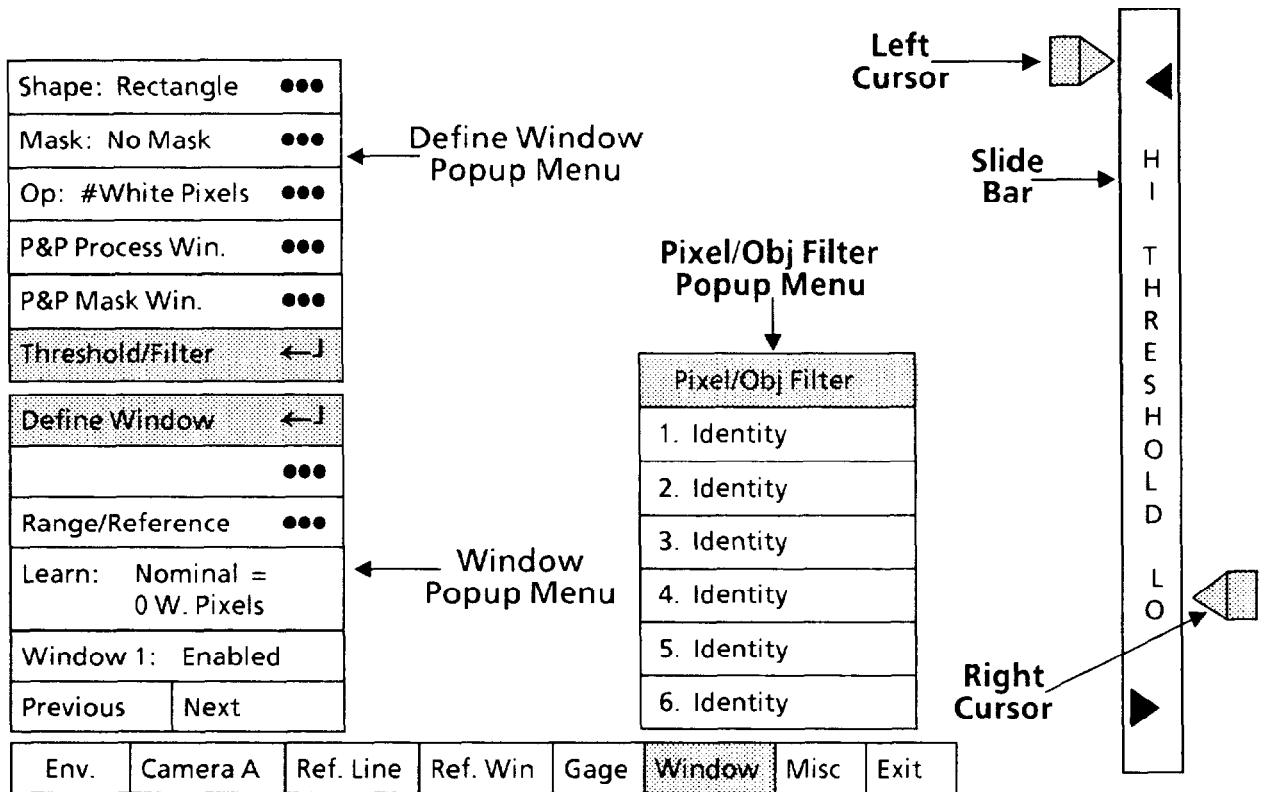

Look at the threshold cursors on each side of the slide bar.

The cursors on each side of the slide bar are the means by which you will set the *initial* contrast between the workpiece feature(s) to be inspected and the adjacent image area.

Think of the slide bar as being a scale with 1 at the bottom and 63 at the top, where 1 represents black, 63 represents white, and all numbers in between represent shades of gray *between* black and white.

**Selecting Define Window
Popup Menu and
Parameters (continued)**

**Using Threshold/Filter Function (Pixel and Object Counts)
(continued)**

Your Action

Comments

Think of the *left* cursor this way: Any part of the image within the window that is *lighter* than the current cursor setting will appear *black* in the window. Thus, if the cursor is set to 45 and some part of the image area is 46 or higher, that part will appear *black* in the window.

Think of the *right* cursor this way: Any part of the image within the window that is *darker* than the current cursor setting will appear *black* in the window. Thus, if the cursor is set to 25 and some part of the image area is 24 or lower, that part will appear *black* in the window.

Any part of the image within the window that is neither *lighter* than the *left* cursor setting, nor *darker* than the *right* cursor setting, will appear *white* in the window. Thus, if the left cursor is set to 45 and the right cursor is set to 25, any part of the image area within the window between those two gray values will appear *white* in the window.

NOTE: The *left* cursor cannot be moved *lower* than the right cursor, and the *right* cursor cannot be moved *higher* than the left cursor.

Pick the left cursor.

To pick the cursor, aim the light pen at it. When you see a red box around the cursor, press the light pen tip against the monitor screen for a moment. This causes the cursor to turn yellow, indicating that you can now "drag" the cursor up and down.

*Drag the left cursor to its
topmost position.*

This initializes the left cursor's position to 63.

*Pick and drag the right cursor
to its bottommost position.*

This initializes the right cursor's position to 1.

With the two cursors positioned this way, the image area within the window should now appear all *white*.

*Check whether the feature to
be inspected should appear
black or white.*

If the feature to be inspected should appear *black* against a *white* background, adjust the right cursor first. On the other hand, if the feature to be inspected should appear *white*, adjust the *left* cursor first.

*Pick and drag the right cursor
upward.*

Drag the right cursor *upward* until the feature to be inspected turns *black* and has the proper dimensions and overall appearance.

or,

*Pick the left cursor again
and drag it downward.*

Drag the left cursor *downward* until the feature to be inspected turns *white* and has the proper dimensions and overall appearance

Selecting Define Window Popup Menu and Parameters (continued)

Using Pixel/Obj Filter Menu

If the feature that you've defined with the cursor(s) has the proper shape, but has "noise" in it (that is, *white* specks in a *black* feature, or *black* specks in a *white* feature), you should select the Pixel/Obj Filter table and use the filter function to try to remove these specks.

The filter function provides two filtering tools:

- The + White/- Black tool, which replaces a layer of black pixels with white pixels.
- The -White/ + Black tool, which replaces a layer of white pixels with black pixels.

Identity signifies *no* filtering.

Here's how you can use the filter function:

Example: Assume that the feature to be inspected is white and has black "noise" in it. Assume further that you have set *three* successive filter table boxes (#1, 2, and 3) to + White/- Black. In doing so, the white pixels in the feature *expanded* and the black pixels *contracted* – the smallest ones (that is, the "noise") disappearing altogether.

This procedure eliminated the black noise, but, at the same time, it *expanded* the size of the white feature. To *restore* the white feature to its original size, you must set the next three filter table boxes (#4, 5, and 6) to -White/ + Black. This will restore the white feature, *minus* the black noise, to its original size.

For your own application, you can experiment with various combinations of filter tools to "clean up" the feature image.

Your Action

Comments

Look at the Pixel/Obj Filter table.

Do all six boxes read Identity? (Note that if you configured the window to count *objects*, box #6 will be "locked" in the -White/ + Black state.)

Reset each filter table box to read Identity, if necessary.

If any box *does not* presently read Identity, pick that box successively until it does. (When you pick a box successively, it will read + White/- Black, -White/ + Black, and Identity.)

Recheck the feature shape.

When all boxes read Identity, you may have to adjust the cursors slightly to re-optimize the feature shape. If the feature shape is again acceptable, but still has "noise" in it, continue with the following steps.

Check for white noise in a black feature.

If the noise consists of white specks in a black feature, use -White/ + Black first, then + White/- Black.

Check for black noise in a white feature.

If the noise consists of black specks in a white feature, use + White/- Black first, then -White/ + Black.

Your objective is to either eliminate "noise" in the binary image or reduce it to an acceptable level.

Selecting Define Window Popup Menu and Parameters (continued)

Configuring Gradient Operations

If you selected the Gradient menu box in the Window Operation popup menu, continue with the following steps. Otherwise, skip this section.

When a window (rectangle, ellipse, or polygon) is configured for the Gradient operation, it can locate an edge or *gradient* between dark and light areas inside the window. It displays the edge or *gradient image* as a thin band of white pixels and counts the number of white pixels in that image.

The following illustration shows how this looks on the monitor screen.

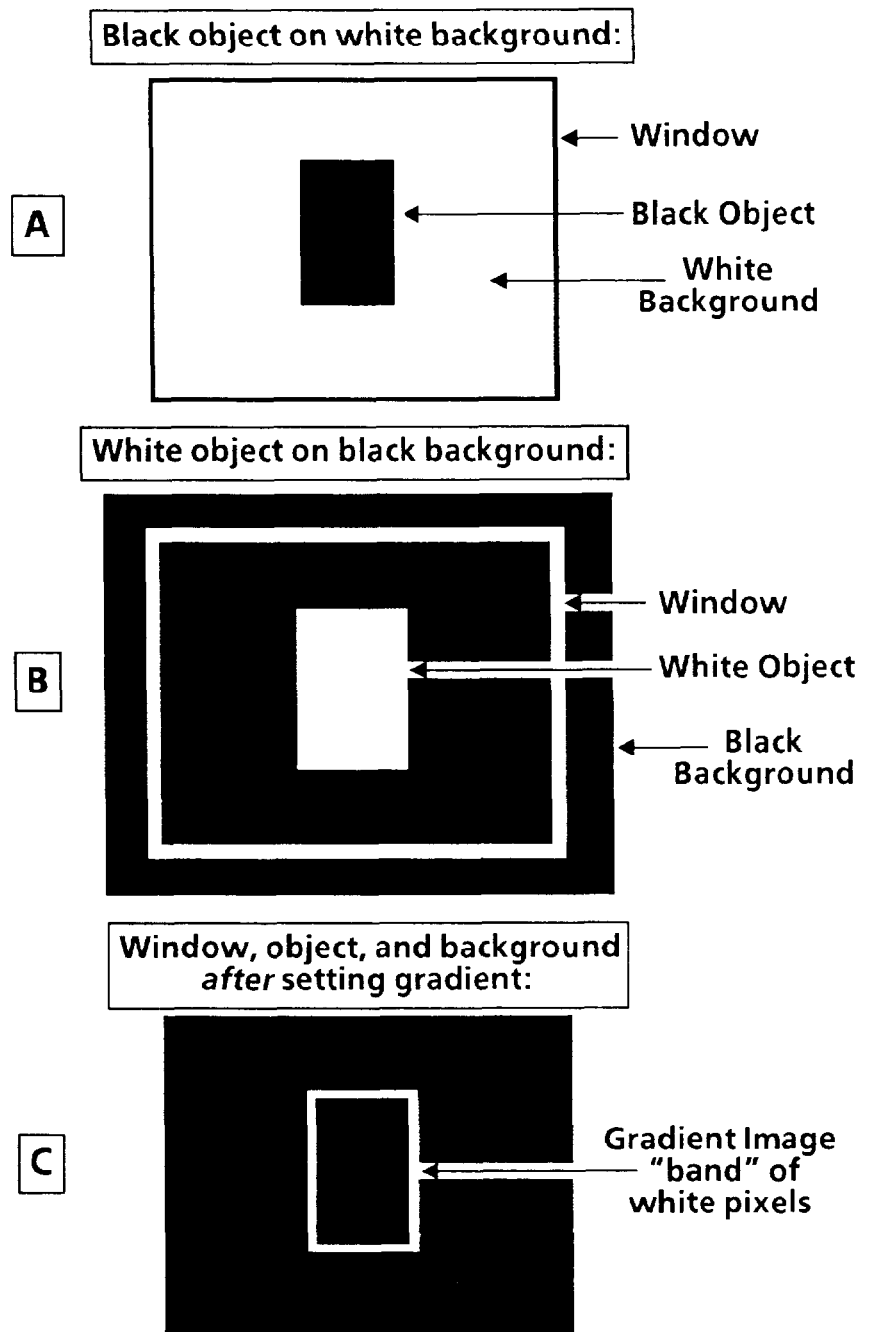

Selecting Define Window
Popup Menu and
Parameters (continued)

Configuring Gradient Operations (continued)

A shows a black object against a white background, and B shows a white object against a black background.

(Note that the objects and backgrounds will appear as shown in A and B *only* when one of the *other* window operations, such as #Black Pixels, is selected. When the Gradient window operation is selected, a window cannot display objects and backgrounds as shown.)

C shows the *gradient image* – the band of white pixels surrounding the object – after the *gradient threshold* is properly adjusted. The objects in A and B will both appear this way following the gradient threshold adjustment.

The gradient threshold is a value, from 1 to 63, representing the difference in the gray scale values of adjacent pairs of pixels within the window. The higher the number, the greater the gray scale difference that is required for the CVIM system to consider a pixel pair to be a gradient.

Each point in the window where the *difference* in the gray scale value of adjacent pairs of pixels is *greater than* the threshold setting is identified as a gradient. The window sets the pixels *white* at all of these points.

Conversely, each point where the *difference* in the gray scale value of adjacent pairs of pixels is *less than* the threshold setting is *not* identified as a gradient. The window sets the pixels *black* at all of these points.

You can selectively turn *on* or turn *off* specific components of the gradient image, and you can also select one of two *widths* for the gradient image.

The following illustration shows how A in the preceding illustration would appear with some components of the gradient image turned *off*.

Black object on white background:



The overall inspection function of the Gradient window operation is to look for specified edge gradients on or around an object and, if found, count the white pixels in the resulting gradient image.

**Selecting Define Window
Popup Menu and
Parameters (continued)**

Using Threshold/Filter Function (Gradient)

Select the Gradient popup menu and gradient threshold-adjusting slide bar. Use the slide bar to set the gradient threshold for the best gradient image. Use the menu to select the width of the gradient image and the sides of the object on which the image is to appear.

Your Action

Pick the Threshold/Filter menu box in the Define Window popup menu.

Comments

When you pick the Threshold/Filter menu box, the Gradient popup menu and gradient threshold slide bar will appear, as follows:

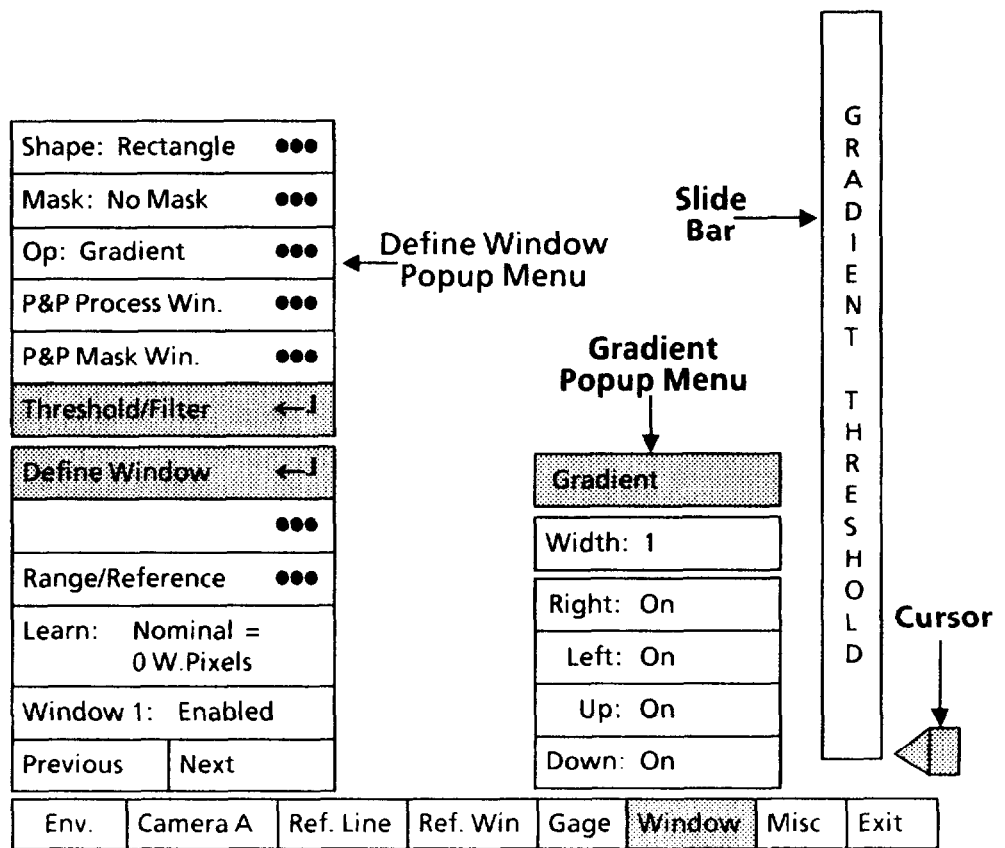

Note that the Width value is "1." This selects the narrower of the two gradient image widths. Width value "2" can be used where appropriate to enhance gradient sharpness or increase the white pixel count.

Note also that the Right, Left, Up, and Down boxes are all set to "On." This turns on all four parts of the gradient image.

Selecting Define Window Popup Menu and Parameters (continued)

Using Threshold/Filter Function (Gradient) (continued)

Your Action	Comments
Look at the Gradient popup menu.	The Gradient menu enables you to selectively turn <i>on</i> or <i>off</i> each of the four components of the gradient image. The menu also enables setting the image to one of two <i>widths</i> .
Pick each menu box that reads "Off."	Picking the "Off" menu boxes toggles them to "On."
Look at the threshold cursor next to the slide bar.	The <i>cursor</i> is the means by which you will set the gradient threshold. The <i>slide bar</i> represents a scale with 1 at the bottom and 63 at the top.
Pick the cursor.	To pick the cursor, aim the light pen at it. When you see a red box around the cursor, press the light pen tip against the monitor screen briefly. This causes the cursor to turn yellow, indicating that you can now "drag" the cursor up and down.
Drag the cursor to its <u>bottommost</u> position.	This initializes the cursor's threshold value to 1.
Slowly, drag the cursor upward.	As you drag the cursor, watch for the gradient image in the window.
Stop the cursor when the gradient image is correct for your application.	If you drag the cursor too far upward, the entire image within the window will turn black. If this occurs, drag the cursor down again. This completes the configuration of the Gradient window operation, unless your application requires turning <i>off</i> some components of the gradient image. If so, continue with the following steps; if not, skip to the section called <i>Selecting Range/Reference Popup Menu and Parameters</i> .

Using Gradient Menu

The lower four menu boxes of the Gradient menu select the *on* or *off* state of the four components of the gradient image.

Gradient
Width: 1
Right: On
Left: On
Up: On
Down: On

The terms *Right*, *Left*, *Up*, and *Down* in the menu boxes refer to the direction that each component of the gradient image *faces*. The four terms also refer to the *search direction* that the window uses to locate each component.

Selecting Define Window Popup Menu and Parameters (continued)

Using Gradient Menu (continued)

Since the search *direction* is always from *dark* to *light*, the following relationship exists between the search direction and the four components of the gradient image:

- The Up search direction relates to the *top-facing* component of the gradient image.
- The Down search direction relates to the *bottom-facing* component of the gradient image.
- The Left search direction relates to the *left-facing* component of the gradient image.
- The Right search direction relates to the *right-facing* component of the gradient image.

Each component of the gradient image consists of one or more parts, according to the shape of the object.

In the following illustration, a multi-sided *dark* object (with a *light* hole) identifies the search direction for each side and the several parts of each gradient image component:

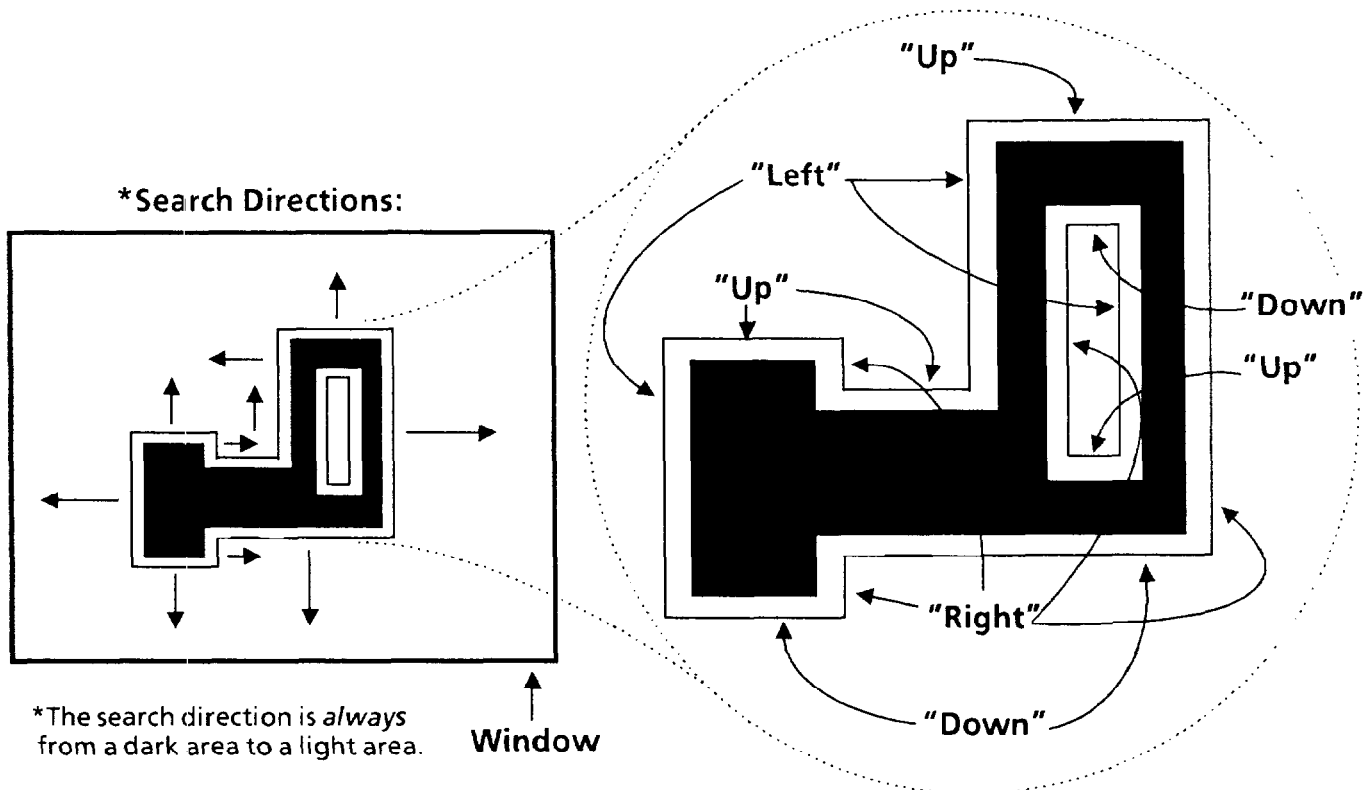

The illustration shows that each gradient image component around (and *inside*) the object consists of several *parts*. Thus, there are four right-facing ("Right") parts, four top-facing ("Up") parts, three left-facing ("Left") parts, and three bottom-facing ("Down") parts.

**Selecting Define Window
Popup Menu and
Parameters (continued)**

Using Gradient Menu (continued)

As an example, if you toggle all four menu boxes to "On," all four components of the gradient image will turn *on*, as shown in A below.

If you toggle the "Right" menu box to "On" and all other menu boxes to "Off," only the four parts of the *right-facing* component of the gradient image will turn *on*, as shown in B.

A

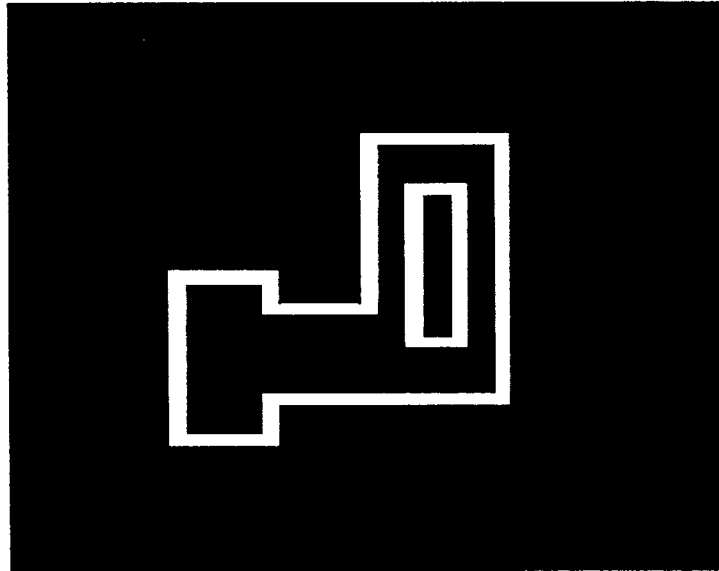

B

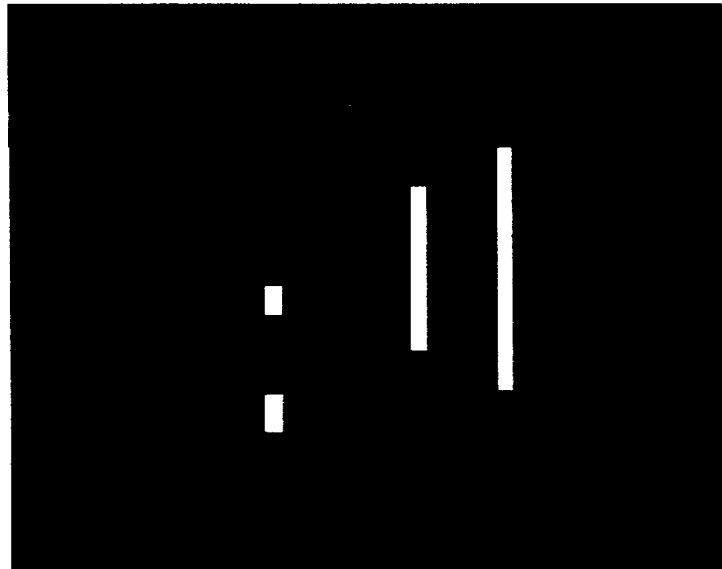

Selecting Define Window Popup Menu and Parameters (continued)

Using Gradient Menu (continued)

Your Action

Look at the Gradient
popup menu again.

Toggle the search direction
menu boxes as required
for your application.

Toggle the Width menu box
to "1" or "2," as required
for your application.

Comments

Each search direction box is either "On" or "Off."

Toggle each search direction box to either "On" or "Off,"
whichever is appropriate for your application.

The "1" width is *narrower* than the "2" width.

This completes the configuration for the Gradient window
operation.

Configuring Template Match Operations

If you selected the Template Match menu box in the Window
Operation popup menu, continue with the following steps.
Otherwise, skip this section and continue with the section
called *Selecting Range/Reference Popup Menu and
Parameters*.

The Template Match operation enables the window to
compare a specified feature on each inspected workpiece
with a stored *reference* image (the "template") of that same
feature.

Note that the Template Match operation can be used only
with a rectangular window *without* a mask.

During an inspection operation, the window examines each
pixel in the *workpiece* image and compares it with the same
pixel in the *stored* template. If the pixel's value – ranging
from 0 (darkest) to 63 (brightest) – lies within the pixel
tolerance limits that you specified, that pixel "passes."

When it has examined all pixels in the workpiece image, the
window reports its "results" as a percentage of *failed* pixels.
For example, if the window size were 100 pixels by 60 pixels,
and 600 pixels had values lying *outside* the specified pixel
tolerance limits, the window would report a result of
 $600/6000 \times 100\% = 10\%$ failed pixels.

NOTE: Before continuing, be sure that you have already
positioned the window over the template feature on the
reference workpiece.

**Selecting Define Window
Popup Menu and
Parameters (continued)**

Configuring Template Match Operations (continued)

Use the following steps to store the template and set the pixel tolerance limit.

Your Action

Comments

Pick the Define Template menu box.

Earlier, when you picked the Template Match menu box, the Window popup menu acquired a "new" menu box – the Define Template menu box. This menu box selects the popup menu, which you will use to store the template and define the pixel tolerance limits.

When you pick the Define Template menu box, the Define Template popup menu will appear, as follows:

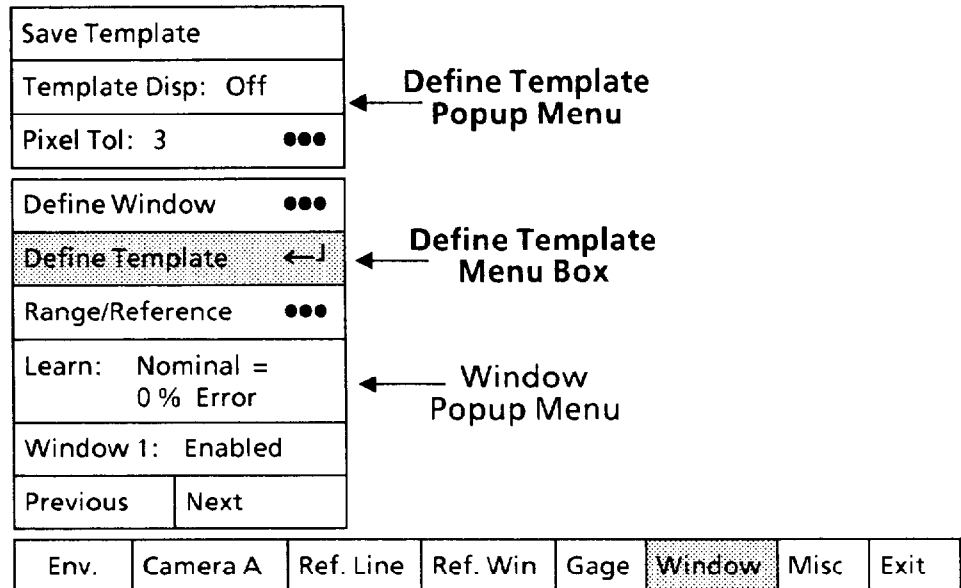

Pick the Save Template menu box.

When you pick the Save Template menu box, the template image in the window is *stored* in CVIM system memory, and the word Delete replaces the word Save in the menu box.

(To *delete* the stored template, pick the menu box again. The stored template will be deleted from memory, and the word Save will replace the word Delete.)

Look at the Template Disp menu box.

The Template Disp menu box indicates whether or not the stored template image will appear on the monitor screen. If On appears, the template image will appear in the upper right corner of the screen. If Off appears, the template image will *not* appear on the screen. Pick the menu box to select the *opposite* status. Pick again to revert to the *previous* status.

Look at the Pixel Tol menu box.

The Pixel Tol menu box indicates the currently selected pixel tolerance limit. For example, if 5 appears, it means that the gray scale value of each pixel in the *workpiece* image must be within ± 5 of the *corresponding* pixel in the *stored* image (the template). Thus, if a pixel in the template has a gray scale value of 23, the corresponding pixel in the workpiece image must have a value of 23 ± 5 (18 to 28).

**Selecting Define Window
Popup Menu and
Parameters (continued)**

Configuring Template Match Operations (continued)

Your Action

Comments

Note that *increasing* the pixel tolerance value will *decrease* the processing time.

Pick the Pixel Tol menu box. When you pick the Pixel Tol menu box, the calculator pad will appear on the monitor screen, as follows:

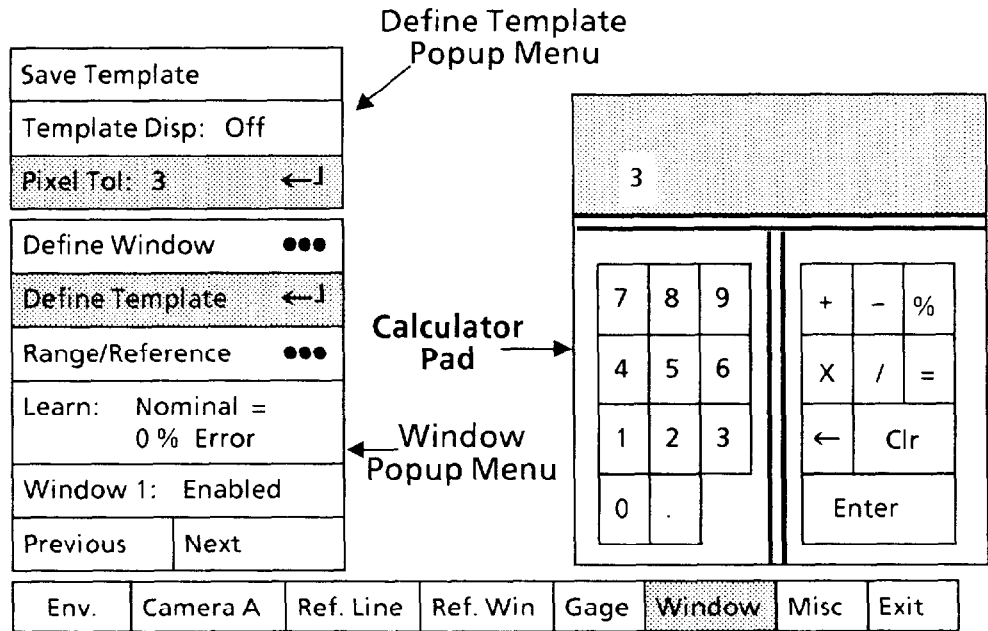

Pick each digit of the new pixel tolerance limits.

As you pick each digit, it will appear in the calculator "display." Thus, for a value of 12, pick "1," then pick "2."

Pick the Enter key.

When you pick the Enter key, the new value will appear in the Pixel Tol menu box.

When you finish entering the pixel tolerance value, proceed to the section called *Selecting Range/Reference Popup Menu and Parameters* to configure the range limits, output lines, and reference tools, as appropriate for your application.

The range limits for a template-matching window are based on the window's inspection "results," which reflect the percentage of pixels that *failed* to match the corresponding pixels in the template.

The question of what is an *acceptable* percentage of failed pixels depends on the requirements of your specific application. To help you determine these requirements, you can use the Learn function and/or run a series of trial inspections. The *Selecting Range/Reference Popup Menu and Parameters* section will show you how.

Using Learn Function

Pick the Learn menu box in the Window popup menu to command the CVIM system to “learn” one of the following values:

- The black or white pixel count.
- The number of black or white objects.
- The average luminance level.
- The percent of pixels that failed to match those in a stored template.

Your Action

Comments

Pick the Learn menu box.

When you pick the Learn menu box, the window “learns” the value according to the operation that you selected for this window.

For example, if you selected the #Black Pixels window operation, the window will “learn” the number of black pixels that it sees *within the window’s boundary*.

Look at the new value in the Learn menu box.

The new value appears in the Learn menu box.

Selecting Range/Reference Popup Menu and Parameters

Select the Range/Reference popup menu, then select the parameters in that menu.

Your Action

Comments

Pick the Range/Reference menu box in the Window popup menu.

When you pick the Range/Reference menu box, the Range/Reference popup menu appears above the Window popup menu, as follows:

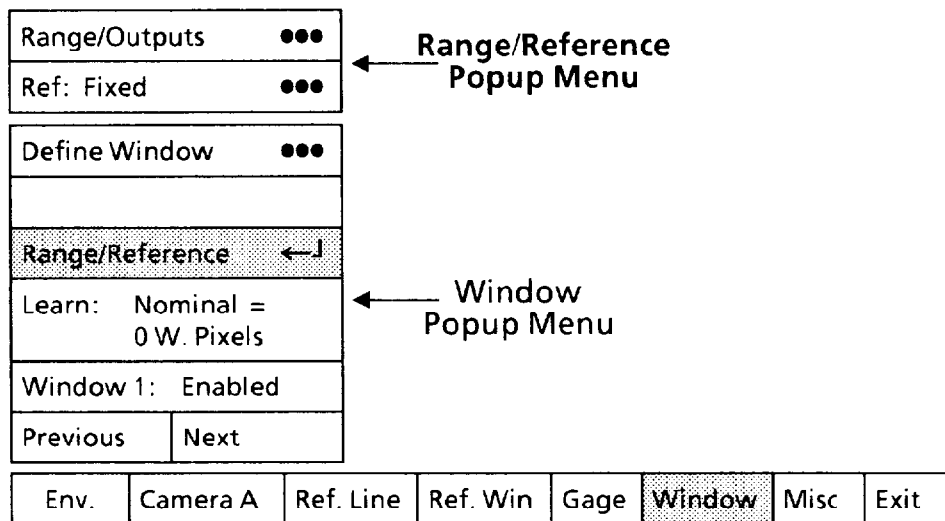

Selecting Range/Reference Popup Menu and Parameters (continued)

Assigning Range Limits and Output Lines

Range Limits – The term *range limit*, as it applies to a window, refers to the upper and lower tolerance limits for the selected window operation.

In general, range limits specify the upper and lower boundaries of acceptable inspection “results” values. Thus, the “result” value could be a pixel count, object count, or other value from the window inspection operation.

The CVIM system provides *two* sets of range limits: *Warning range* limits, and *fault range* limits. Warning range limits always lie *within* fault range limits or be equal to them.

The two sets of range limits have this relationship:

$$LF < = LW < = \text{REFERENCE} < = UW < = UF$$

The **REFERENCE** value could be the “nominal” value from a Learn operation, or a “mean” value from a trial inspection series. For example, if the **REFERENCE** value were 1500 pixels,

- The **LW** value (lower warning limit) could be set to 1480 pixels.
- The **UW** value (upper warning limit) could be set to 1520 pixels.
- The **LF** value (lower fault limit) could be set to 1460 pixels.
- The **UF** value (upper fault limit) could be set to 1540 pixels.

If an inspection result value goes outside either warning limit, the CVIM system will generate a warning signal. If the value goes outside *both* a warning limit *and* a fault limit, the CVIM system will generate both a warning signal *and* a fault signal.

In a practical application, the warning range limits can be used to indicate a deteriorating condition, such as a cutting tool starting to wear out, and the fault limits can be used to indicate a “hard” failure, such as a broken cutting tool.

Output Lines – The term *output lines* refers to the 14 discrete output lines assigned to carry various signals to your production equipment. Of these signals, the “results” and master range signals indicate whether or not any of the warning and/or fault range limits have been exceeded.

Here are a couple of examples of using the warning and fault range limits and their corresponding output lines:

Example 1: If the size of stamped-out hole in a metal plate changes as the die wears, and drifts outside the specified warning limit, the CVIM system will issue a signal to the “results” output line that you specified for the window’s warning signal. The inspection processing will then continue.

Selecting Range/Reference Popup Menu and Parameters (continued)

Assigning Range Limits and Output Lines (continued)

The warning signal could be used to inform operations personnel that the die needs to be replaced soon, but not necessarily right away. They could then plan to replace the die at a convenient time, such as a shift change, rather than being forced to shut down during a shift.

Example 2: If a stamping die breaks, the size of the stamped-out hole could change abruptly outside both the warning limit and the fault limit. In this case, the CVIM system will issue both a warning signal and a fault signal to the specified "results" output lines, and the inspection processing would then stop.

The fault signal could be used to inform operations personnel that the tool needs to be replaced right away.

Two procedures are available for determining the appropriate range limits for your application: The *shorter* procedure is to use the Learn function described earlier. The *longer* procedure is to run a series of inspections on a representative sample of workpieces in order to accumulate a *statistical* basis for setting the range limits.

The following steps describe the *shorter* procedure using the Learn function:

Your Action	Comments
<i>Position a "perfect" workpiece in the monitor screen.</i>	The "perfect" workpiece should be one on which the workpiece dimension or other characteristic that the window is to inspect is in the <i>middle</i> of the tolerance range; that is, ± 0 .
<i>Perform a Learn function, as described earlier.</i>	Before you perform the "learn" function, be sure the window is properly positioned over the workpiece in the monitor screen and the threshold (if applicable) is correctly set.
<i>Record the value shown in the menu box.</i>	This value is the count or measurement for the "perfect" workpiece.
<i>Position a <u>minimum-tolerance</u> workpiece in the screen.</i>	The "minimum-tolerance" workpiece should be one on which the workpiece dimension or other characteristic is at the <i>low end</i> of the tolerance range. This is the dimension or characteristic <i>below</i> which the workpiece is <i>unacceptable</i> .
<i>Perform a second Learn function and record the value.</i>	This value is the count or measurement for the "minimum-tolerance" workpiece.

Selecting Range/Reference Popup Menu and Parameters (continued)

Assigning Range Limits and Output Lines (continued)

Your Action

Position a maximum-tolerance workpiece in the screen.

Perform a third Learn function and record the value.

Comments

The "maximum-tolerance" workpiece should be one on which the workpiece dimension or other characteristic is at the *high end* of the tolerance range. This is the dimension or characteristic *above* which the workpiece is *unacceptable*.

This value is the count or measurement for the "maximum-tolerance" workpiece.

You can use these three values to determine the appropriate fault and warning range limits for this window.

The following steps describe the *longer* procedure using a trial series of inspections:

Your Action

Prepare to run a series of "trail" inspections.

Comments

Refer to Chapter 10, *Runtime Operations* for more details about the following steps.

For these trial inspection series, you should have on hand a sufficiently large quantity of representative workpieces.

If you cannot use the actual factory-floor setting to perform these trial inspections, you can manually position each workpiece in front of the camera and use a manual trigger, or use some type of automatic positioning and triggering mechanism that approximates the factory-floor situation.

Pick the Exit menu box in the Main Configuration menu.

When you pick the Exit menu box, the Exit popup menu will appear.

Pick the Runtime Init. menu box in the Exit menu.

When you pick the Runtime Init. menu box, the Runtime Init. popup menu will appear.

Look at the Mode menu box in the Runtime Init. menu.

If "Standard" appears, pick the box *once* to toggle to "Learn." This activates the "learn" mode during the trial inspection series and ensures the accumulation of "results" data for this window in the statistics tables.

Pick the Runtime Display menu box in the Exit menu.

When you pick the Runtime Display menu box, the Runtime Display popup menu will appear.

Pick the Stat. Page 1 menu box in the Runtime Display menu.

The Stat. Page 1 menu box causes page one of the statistics tables to appear on the monitor screen when you activate the run mode. Page one displays "results" statistics for all *enabled* windows.

**Selecting Range/Reference
Popup Menu and
Parameters (continued)**

Assigning Range Limits and Output Lines (continued)

Your Action	Comments
<i>Pick the Runtime menu box in the Exit menu.</i>	When you pick the Runtime menu box, the Runtime popup menu will appear.
<i>Pick the Goto Runmode menu box in the Runtime menu.</i>	When you pick the Goto Runmode menu box, the CVIM system will begin running inspections <i>if you selected Auto/Internal as the trigger source</i> . If not, the system will await trigger inputs from whatever trigger source you selected.
<i>Look the statistics table.</i>	As the inspections continue, the Stat. Page 1 table will display accumulated "results" data <i>only</i> for each <i>enabled</i> window. <i>No data</i> will appear for a window that is <i>not</i> enabled.
<i>When you have enough inspections, look at the four statistics columns in the Stat. Page 1 table.</i>	These columns show the <i>mean, standard deviation, minimum reading, and maximum reading</i> statistics for the inspection series.
<i>Pick the Setup menu box to <u>stop</u> the runmode.</i>	These statistics are your basis for configuring the range limit values for the currently selected window. Picking the Setup menu box <i>stops</i> the run mode and returns the CVIM system to the configuration mode. At this time, the <i>final</i> data appearing in the Stat. Page 1 table are recorded in the Inspection Statistics table for the currently selected window. You will see this when you pick the Range/Outputs menu box in the Range/Outputs popup menu.
<i>Pick the Window menu box.</i>	This restores the Window popup menu.
<i>Select the window number.</i>	This restores the window number whose range limits you want to set.
<i>Pick the Range/Reference menu box.</i>	This restores the Range/Reference popup menu.

**Selecting Range/Reference
Popup Menu and
Parameters (continued)**

Assigning Range Limits and Output Lines (continued)

Use the following steps to set range limits and assign output lines.

Your Action

Comments

Pick the Range/Outputs menu box in the Range/Reference popup menu.

When you pick the Range/Outputs menu box, two tables will appear on the monitor screen, as follows:

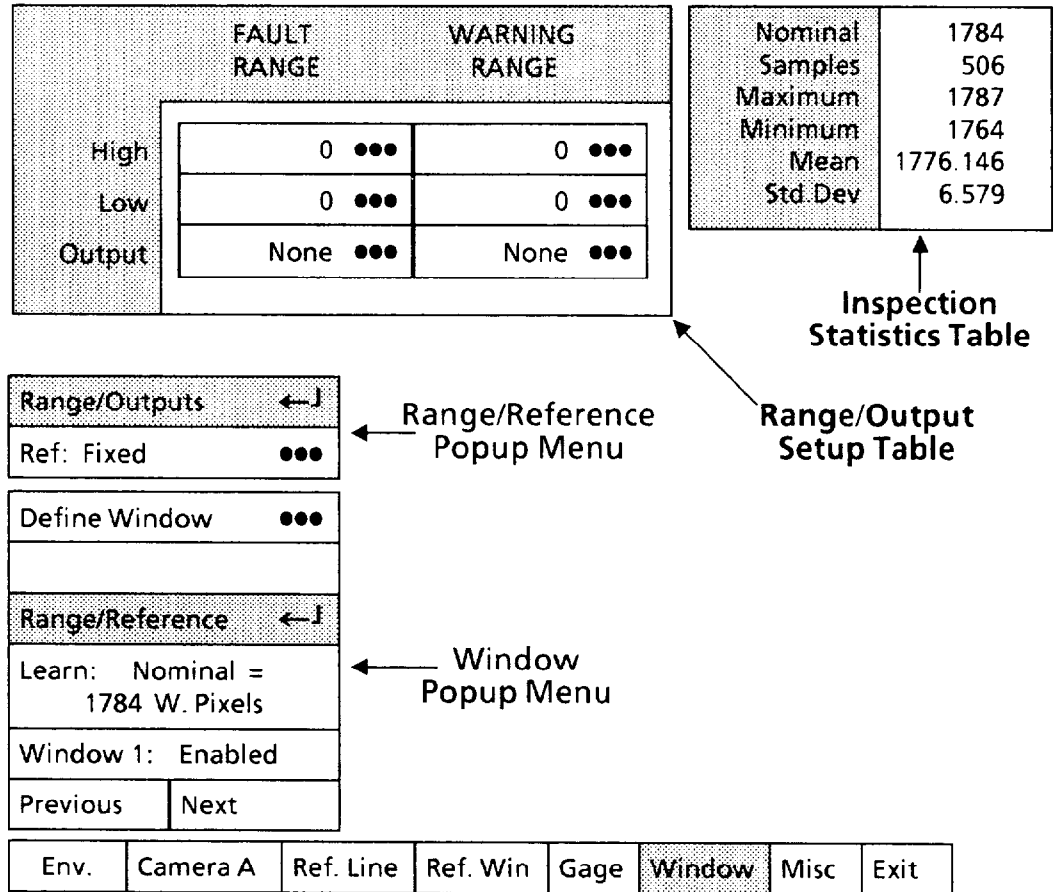

The Range/Outputs table is the one you will use to set the range limits and assign the output lines. The numbers appearing in it now are the limits and lines set previously. Note that each box in the table has the three dots (●●●), which indicates that you will need to pick each box, one at a time, in order to set its value.

The Inspection Statistics table shows the statistical accumulation of inspection "results" data if you performed a series of inspections with the CVIM system running in the "learn" mode. These numbers can help you choose the best values for the range limits.

**Selecting Range/Reference
Popup Menu and
Parameters (continued)**

Assigning Range Limits and Output Lines (continued)

The next several steps show you how to enter values for the range limits.

NOTE: The order in which these steps are presented may not be the appropriate order in *all* cases. If not, a blinking message will appear in the calculator display that says: **VALUE OUT OF RANGE**. For example, this message will appear if you attempt to change the *upper* warning range limit to a value below the *lower* warning range limit.

Your Action

Comments

Pick the *upper* box under **WARNING RANGE**.

This is the warning range upper ("High") limit. When you pick this box, the calculator pad appears on the monitor screen, as follows:

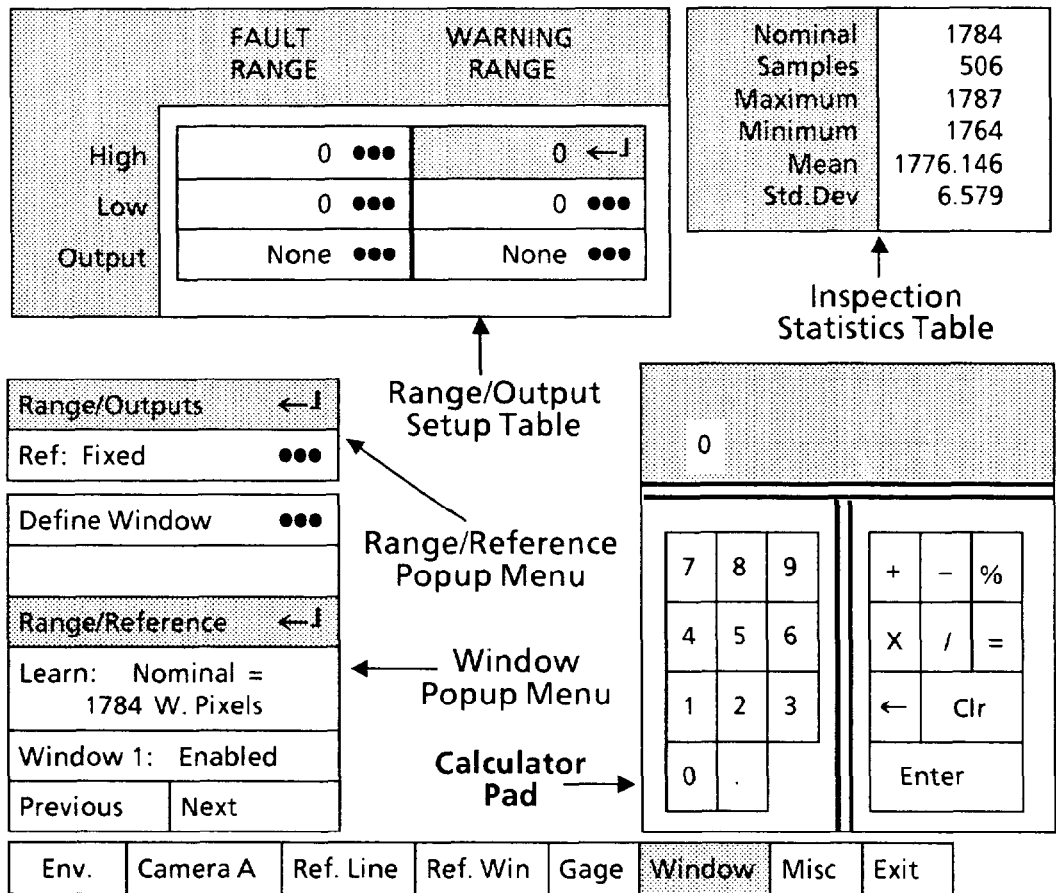

Pick each digit of the upper warning limit value.

As you pick each digit, it will appear in the calculator "display." Thus, for a value of 69, pick "6," then pick "9."

Pick the Enter key.

When you pick the Enter key, the new value will appear in the upper box under **WARNING RANGE**.

Pick the *middle* box under **WARNING RANGE**.

This is the warning range lower ("Low") limit.

Pick each digit of the lower warning limit value.

As you pick each digit, it will appear in the calculator "display."

**Selecting Range/Reference
Popup Menu and Parameters
(continued)**

Assigning Range Limits and Output Lines (continued)

Your Action	Comments
Pick the Enter key.	When you pick the Enter key, the new value will appear in the middle box under WARNING RANGE.
Pick the <u>upper</u> box under FAULT RANGE.	This is the fault range upper ("High") limit.
Pick each digit of the upper fault limit value.	As you pick each digit, it will appear in the calculator "display."
Pick the Enter key.	When you pick the Enter key, the new value will appear in the upper box under FAULT RANGE.
Pick the <u>middle</u> box under FAULT RANGE.	This is the fault range lower ("Low") limit.
Pick each digit of the lower fault limit value.	As you pick each digit, it will appear in the calculator "display."
Pick the Enter key.	When you pick the Enter key, the new value will appear in the middle box under FAULT RANGE.
Pick the <u>lower</u> box under WARNING RANGE.	When you pick this box, a variation of the Output Assignment popup menu appears on the monitor screen, as follows:

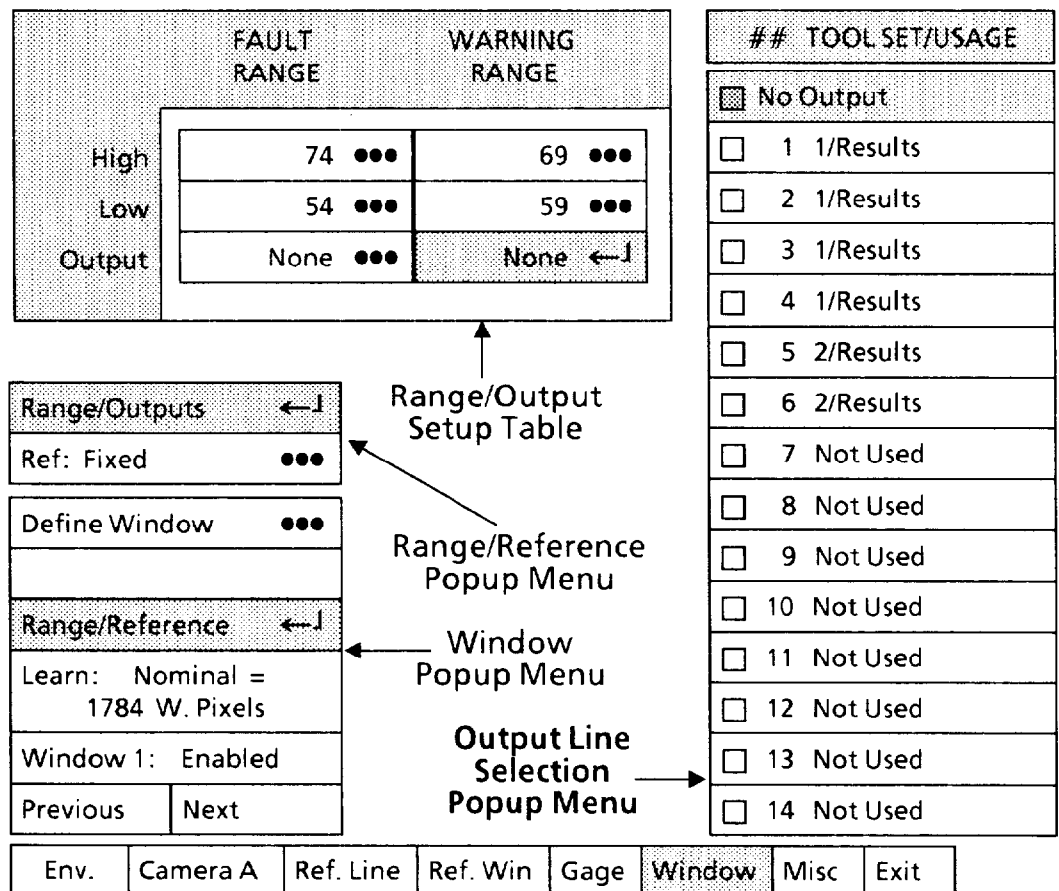

**Selecting Range/Reference
Popup Menu and Parameters
(continued)**

Assigning Range Limits and Output Lines (continued)

Your Action

Comments

This is the Output Line Selection popup menu. It shows the output line functions that you assigned to the Output Assignment popup menu in Chapter 4, *Operating Environment*.

NOTE: This menu shows that only the output lines that you designated in Chapter 4 as "1/Results" are available to this window if it is in tool set #1 ("2/Results" if the window is in tool set #2). These appear in light type, and all others appear in **black type** (meaning that you cannot pick them).

Note also that the No Output box in the Output Line Selection popup menu has a shaded square (◻). This indicates that *no* output line is currently assigned to carry WARNING RANGE signals for this window.

If you prepared an Output Line Planning Sheet in Appendix A, refer to it for the output line assignments for this window.

*Pick the output line number
for the WARNING RANGE.*

From the Output Line Selection popup menu, pick one of the available output lines boxes labeled "1/Results". When you pick the appropriate box, the shaded square will shift to it.

In addition, the output line number appears in the lower box under WARNING RANGE.

*Pick the lower box under
FAULT RANGE.*

*Pick the output line number
for the FAULT RANGE.*

From the Output Line Selection popup menu, pick one of the available output lines boxes labeled "1/Results". When you pick the appropriate box, the shaded square will shift to it.

In addition, the output line number appears in the lower box under FAULT RANGE.

**Selecting Range/Reference
Popup Menu and Parameters**
(continued)

Selecting Reference Popup Menu

Select the Reference popup menu, if appropriate, then assign a reference tool to provide shift and/or rotation compensation to the currently selected window.

You can configure CVIM so that one of the six reference tools provides shift compensation to a window. During an inspection, if the reference tool detects shift and/or rotation in the workpiece, it shifts and/or rotates the window a corresponding amount and direction.

Use the following steps to select a reference tool for the currently selected window.

Your Action

Comments

Look at the Ref menu box in the Range/Reference popup menu.

The Ref menu box shows the currently selected reference tool assigned to *this* window.

Pick the Ref menu box.

When you pick the Ref menu box, the Reference popup menu appears, as follows:

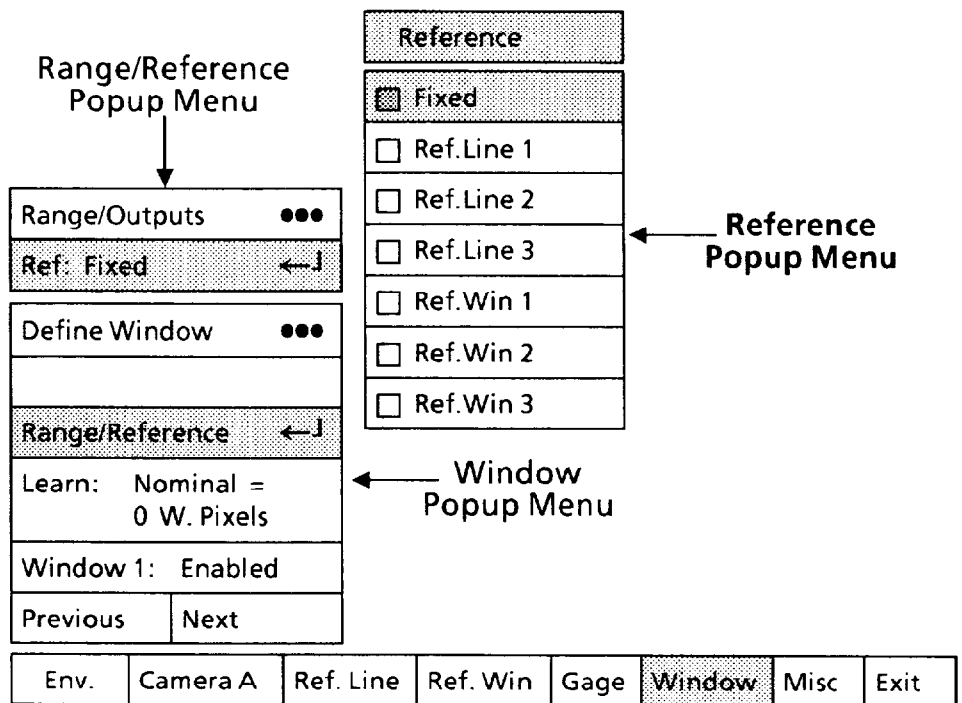

Note that the Fixed box in the Reference menu has a shaded square (◻). This indicates that a reference tool is not currently assigned to *this* window. Also note that only the *available* reference tools are in *light* type. All others are shown in **black** type, which indicates that you cannot pick them.

Pick the appropriate reference tool from the menu.

If appropriate, pick one of the available reference tools from the Reference menu.

Chapter 9 Configuration Aids and Storage Functions

Chapter Objectives

This chapter shows you how to use the configuration aids and the configuration storage and retrieval functions in the Misc popup menu. This menu appears when you pick the Misc menu box in the Main Configuration menu.

Configuration Aids and Storage: Overview

The following functions enable you to store and retrieve configurations and help you adjust the stored configurations to changes that may occur in workpiece position.

- **Archive:** The CVIM system can store and retrieve configurations and screen images using either its internal non-volatile memory or a plug-in, credit card-sized, battery-backed random access memory (RAM card).

Separately, the CVIM system can also send (*upload*) configurations to computer or PLC equipment, and then receive (*download*) those same configurations later, during runtime operations. Since these functions involve *data communications*, they are described in the *CVIM Communications Manual*, Catalog No. 5370-ND002.

- **Snapshot:** This function provides a convenient way to acquire a single camera image or display the test pattern.

- **Analysis:** This function calculates the elapsed time that the system requires to perform an inspection operation for one or more analysis tools.

- **Registration:** This function provides a convenient way of re-registering inspection tools to a workpiece when the workpiece position has been moved from its original location in the camera image.

All of these functions are in the Misc popup menu, which you can access after picking the Misc menu box in the Main Configuration menu.

Using Configuration Aids and Storage Functions

This section shows you the details of selecting and using the configuration aids and storage functions.

You will pick the Misc menu box in the Main Configuration menu, which will display the Misc popup menu. You can then select a configuration aid or storage function from one of the menu boxes in the Misc popup menu.

The menu boxes correspond to the four functions listed in the overview.

Selecting Misc Popup Menu Your first step is to select the Misc popup menu.

Your Action	Comments
<i>Pick Misc in the Main Configuration menu.</i>	When you pick the Misc menu box, the Misc popup menu appears above the Main Configuration menu, as follows:

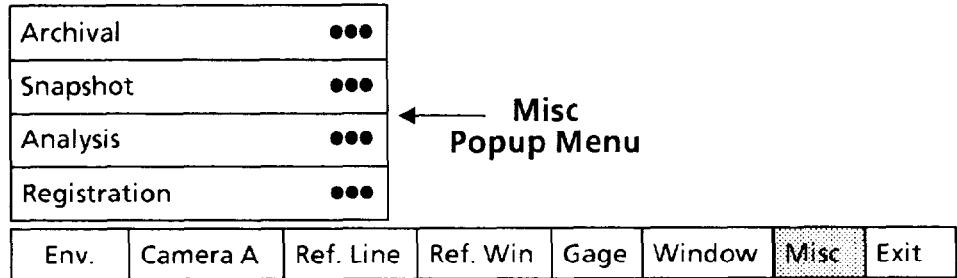

Selecting Archival Popup Menu Select the Archival popup menu, then select the appropriate configuration storage or retrieval function.

Your Action	Comments
<i>Pick the Archival menu box in the Misc popup menu.</i>	When you pick the Archival menu box, the Archival popup menu appears above the Misc popup menu, as follows:

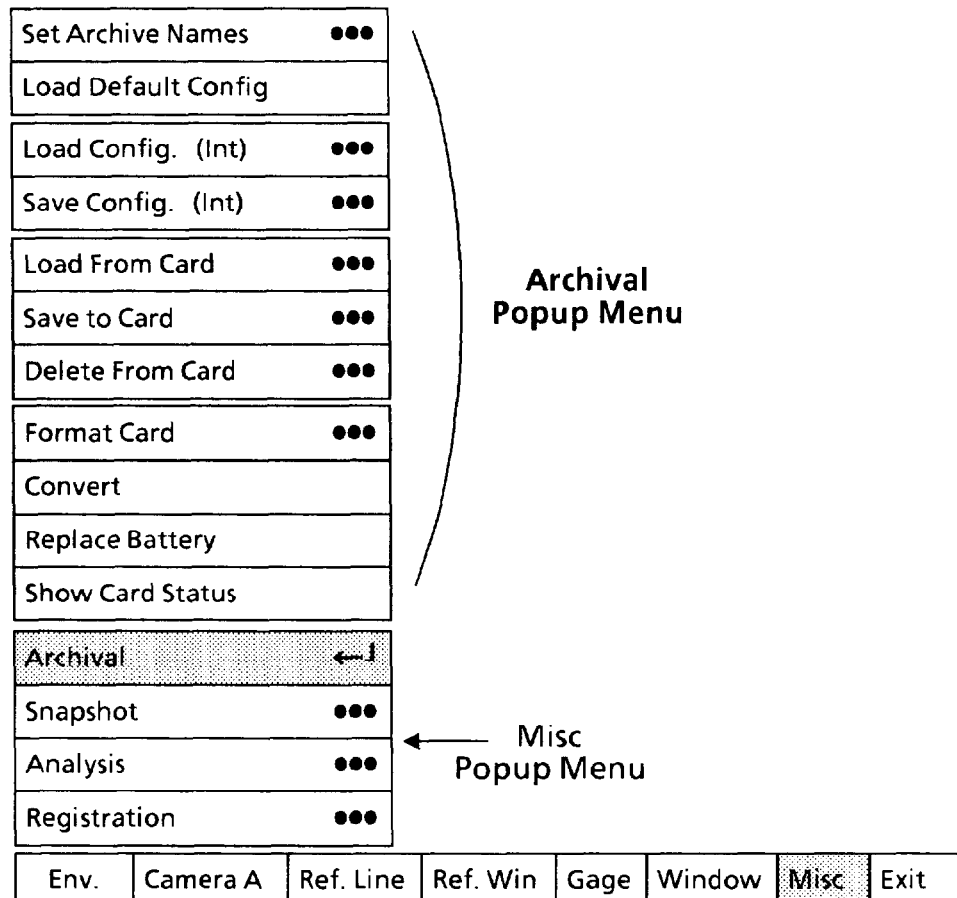

**Selecting Archival Popup
Menu (continued)**

From the top down, these are the functions in the Archival popup menu:

- **Set Archive Names:** When you pick this function, you can give a name to the current configuration and screen image. The name can contain up to 16 characters consisting of any mix of alphanumeric, punctuation, and other characters.
- **Load Default Config:** When you pick this function, the default configuration overwrites the current configuration.
- **Load Config. (Int):** When you pick this function, the previously stored configuration is *retrieved* from the non-volatile, random access memory (EEPROM) in the CVIM module.
- **Save Config. (Int):** When you pick this function, the current configuration is *stored* in the EEPROM.
- **Load From Card:** When you pick this function, the previously stored configuration or image data is *retrieved* from a RAM card, which can be inserted in the Archive Memory slot on the CVIM module front panel.
- **Save to Card:** When you pick this function, the current configuration or image is *stored* in the RAM card.
- **Delete From Card:** When you pick this function, you can *delete* any of the stored configuration(s) and/or image(s) from the RAM card.
- **Format Card:** When you pick this function, the RAM card is reformatted for storing either configuration or image data. Previous data is overwritten by the default values.
- **Convert:** This function is accessible *only* when you insert a RAM card containing configurations or images from an earlier CVIM revisions. When you pick this function, the earlier configurations or images are converted to the current CVIM revisions.
- **Replace Battery:** When you pick this function, the RAM card receives power from the CVIM module, thereby enabling you to replace the battery without losing data.
- **Show Card Status:** When you pick this function, a message appears on the monitor screen showing the RAM card status.

In the next several steps, select the storage or retrieval function or the card-formatting function from the Archival popup menu.

Selecting Archival Popup Menu (continued)

Using Set Archive Names Function

Use this function to name the current configuration and/or current screen image. You can choose any name consisting of up to 16 alphanumeric, punctuation, and miscellaneous printable characters, including the "space" character.

Your Action

Comments

Pick the Set Archive Names menu box, if appropriate.

When you pick the Set Archive Names menu box, the Format Card popup menu will appear alongside the Archival popup menu, as follows:

Set Archive Names
Config:
Image:

The Set Archive Names popup menu is shown as it appears when no names have been assigned.

Pick the Config or Image menu box, as appropriate, to assign a new name.

When you pick the Config or Image menu box, a "typewriter keyboard" will appear on the screen, as follows:

Current name :															
New name :															
1	2	3	4	5	6	7	8	9	0	-	=	←	Cl		
Q		W	E	R	T	Y	U	I	O	P	[]	Ret		
A		S	D	F	G	H	J	K	L	;	'	\	Esc		
↑	Z	X	C	V	B	N	M	,	.	/	Space	↑			

The space above the keyboard is shown as it appears when no names have been assigned. If a name had been assigned, it would appear after Current name. When you enter a new name, it will appear after New name.

Selecting Archival Popup Menu (continued)

Using Set Archive Names Function (continued)

Your Action

Comments

The keyboard has five function keys:

1. The *backspace* key (←) erases the last character entered and moves the cursor (^) left one space.
2. The Esc (*“escape”*) key returns to the Set Archive Names popup menu without changing the current name, if any.
3. The *shift* keys (↑ ↓) cause several of the keyboard characters to change between “upper case” and “lower case” characters. The *alphabet* characters, however, remain in upper case form.

The preceding keyboard illustration shows the “lower case” character set, while the following illustration shows the “upper case” character set.

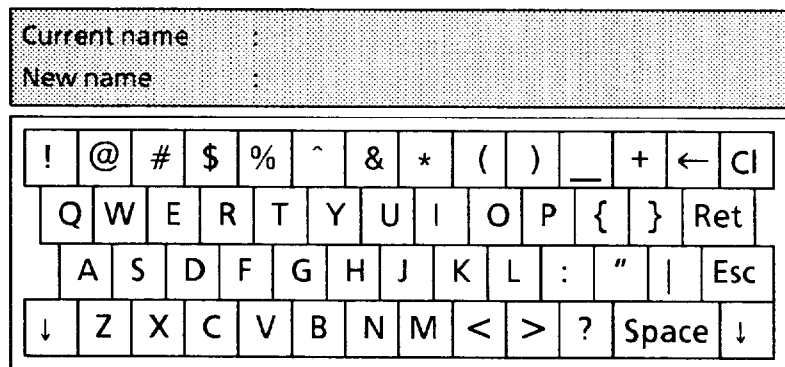

4. The CI (*“clear”*) key sets the New name line to all blanks.
5. The Ret (*“return”*) key enters the new name into the appropriate menu box in the Set Archive Names popup menu.

Pick each character of the new name.

Pick the Ret key to enter the new name.

As you pick the characters, they will appear after New name.

When you pick the Ret key, the new name will appear in the appropriate menu box in the Set Archive Names menu, as follows.

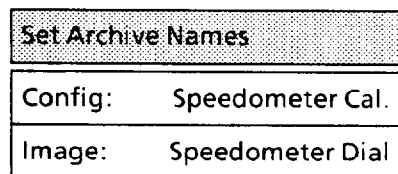

Selecting Archival Popup Menu (continued)

Using Save Config. (Int) Function

Use this function to store the current configuration (located in the CVIM system RAM) in the CVIM module's EEPROM.

Your Action

Pick the Save Config. (Int) menu box, if appropriate.

Comments

When you pick the Save Config. (Int) menu box, the CVIM system will *store* the current configuration in the EEPROM. The following message appears in the message box at the upper-left part of the screen:

Saving Configuration

This indicates that configuration storage is under way. After a moment, the following message appears in the message box:

Configuration Saved

This indicates that configuration storage is finished.

Using Load Config. (Int) Function

Use this function to load the configuration stored in the CVIM module's EEPROM into the CVIM system RAM.

Your Action

Pick the Load Config. (Int) menu box, if appropriate.

Comments

When you pick the Load Config. (Int) menu box, the following message appears in the message box:

WARNING: Loading a new configuration will destroy the current configuration. Reselect to confirm and begin load.

This message is intended to inhibit overwriting the current configuration *unintentionally*. If you are certain that you are ready to load the stored configuration, continue.

Selecting Archival Popup Menu (continued)**Using Load Config. (Int) Function (continued)****Your Action**

Pick the Load Config. (Int) menu box again, if appropriate.

Comments

When you pick the Load Config. (Int) menu box again, the CVIM system will *retrieve* the configuration stored in the EEPROM. This configuration will overwrite the *current* configuration.

The following message appears in the message box:

Loading Configuration

This message indicates that configuration loading is under way.

After a moment, the following message appears in the message box:

Configuration Loaded

This message indicates that configuration loading is finished.

Using Load Default Config Function

Use this function to load the default configuration, which is stored in the CVIM module's ROM.

Your Action

Pick the Load Default Config menu box, if appropriate.

Comments

When you pick the Load Default Config menu box, the following message appears in the message box:

WARNING: Loading a new configuration will destroy the current configuration. Reselect to confirm and begin load.

This message is intended to inhibit overwriting the current configuration *unintentionally*. If you are certain that you are ready to load the default configuration, continue.

**Selecting Archival Popup
Menu (continued)****Using Load Default Config Function (continued)****Your Action**

Pick the Load Default Config menu box again, if appropriate.

Comments

When you pick the Load Default Config menu box again, the default configuration will begin loading. The default configuration will overwrite the *current* configuration.

The following message appears in the message box:

Loading Configuration

This message indicates that the default configuration loading is under way.

After a moment, the following message will appear in the message box:

Configuration Loading

This message indicates that the default configuration loading is finished.

**Selecting Archival Popup
Menu (continued)****Preparing RAM Card**

If you need to format a RAM card, store configuration or camera image data on a RAM card, or retrieve configuration or image data from a RAM card, use the following steps:

Your Action

*Move the Write Protect switch
to OFF.*

Comments

Use the OFF position *only* when formatting the RAM card or storing configuration or image data.

The write protect switch is located on the back edge of the RAM card, as shown below:

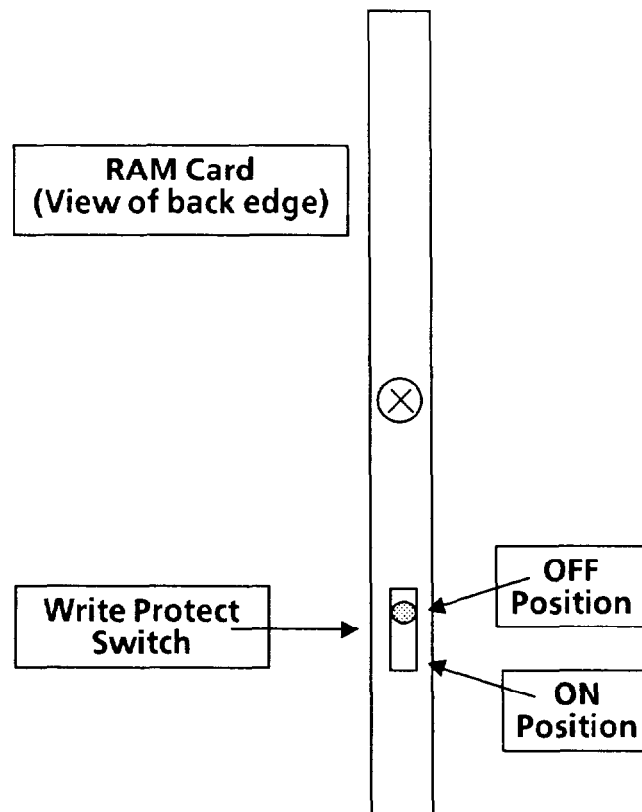

Use a ball point pen or similar instrument to move the write protect switch. When the switch is in the OFF position, you can format the card and/or store configuration or image data.

Selecting Archival Popup Menu (continued)

Preparing RAM Card (continued)

Your Action

Insert the RAM card into the Archive Memory slot on the CVIM module.

Comments

Insert the end with the metal strip facing right (the arrow on the card label should also be facing right.)

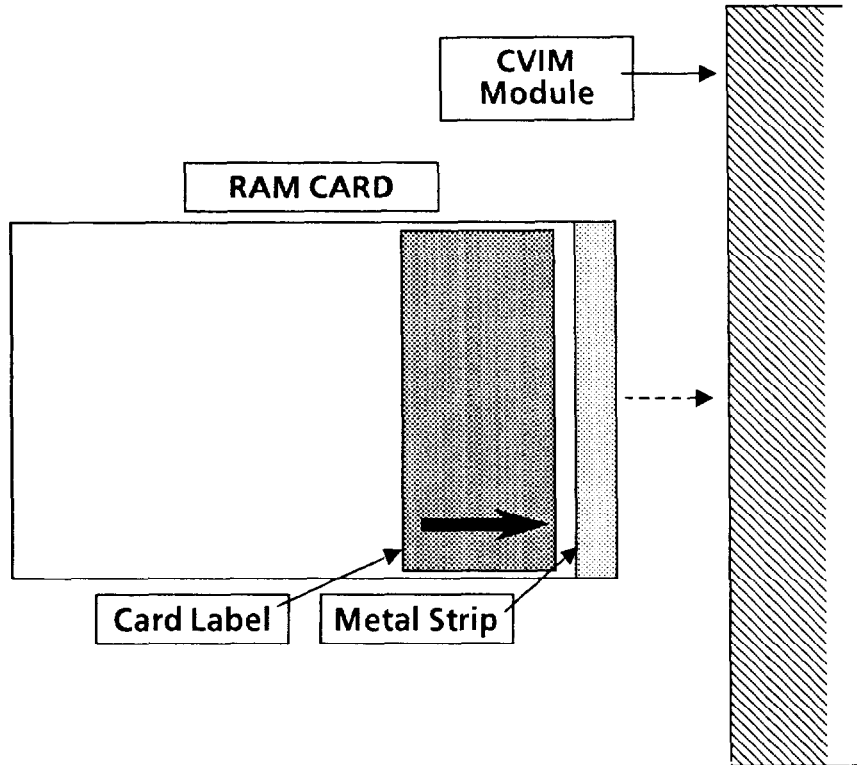

Pick the Show Card Status menu box.

When you pick the Show Card Status menu box, the following message will appear in the message box:

```

MEMORY CARD STATUS
Format: Cfg/lmg Data      Write Protect: Off
Size: 64K      Battery: OK      Error: None
    
```

Note that the memory size could be different than the one shown.

Verify that the battery is OK and the Write Protect switch is set to OFF.

NOTE: If the message indicates that the battery is *low*, you must replace the battery before continuing.

If the battery is OK, skip the next two steps.

If the battery is low, obtain a new battery, then use the next two steps to replace the battery.

Selecting Archival Popup Menu (continued)**Preparing RAM Card (continued)****Your Action**

With the RAM card inserted in the card slot, pick the Replace Battery menu box.

Comments

When you pick the Replace Battery menu box, the following message will appear in the message box on the monitor screen:

**The memory card battery may now be replaced.
Depress the lightpen once this has been done.**

Replace the battery.

NOTE: The RAM card is now receiving power from the CVIM module *and must remain in the slot*. This will ensure retention of the contents while you replace the battery.

Replace the battery using the tool and instructions included with the new battery. When you finish, press the light pen tip. The message will disappear.

Using Format Card Function

Use this function to format the RAM card for storing either configuration data or image data.

Your Action

Pick the Format Card menu box.

Comments

When you pick the Format Card menu box, the Format Card popup menu appears alongside the Archival popup menu, as follows:

Format Card

Cfg/Img Data

Pick the Config./Img menu box.

When you pick either menu box, the following message appears in the message box:

Formatting Memory Card

After a moment, the following message appears in the message box:

Format Complete

Selecting Archival Popup Menu (continued)

Using Format Card Function (continued)

Your Action

Comments

Note that the Memory Active LED on the CVIM front panel blinks for a few seconds, then goes out. When the LED goes out, the formatting is finished.

Using Save to Card Function

Use this function to store either the current configuration or the current screen image in the battery-backed RAM card.

Your Action

Comments

Pick the Save to Card menu box, if appropriate.

When you pick the Save to Card menu box, the Directory popup menu appears, as follows:

Directory	
Empty	: Config
Empty	: Image

Pick the Config. or Image menu box, whichever is appropriate.

The Directory popup menu is shown as it appears when the RAM card contains no configurations or screen images.

Picking the Config. menu box stores the current configuration; picking the Image menu box stores the current screen image.

When you pick the appropriate menu box, the system will store the configuration or image in the RAM card. One of the following messages will appear in the message box:

Saving Configuration

Saving Image

These messages indicate that configuration or image storage is under way.

NOTE: Do not remove the RAM card yet.

**Selecting Archival Popup
Menu (continued)****Using Save to Card Function (continued)****Your Action****Comments**

After a moment, one of the following messages will appear in the message box:



Configuration Saved



Image Saved

These messages indicate that the configuration or image storage is *finished*, and you can now safely remove the RAM card.

Using Load From Card Function

Use this function to load either a system configuration or a screen image from the RAM card.

Your Action

Pick the Load From Card menu box, if appropriate.

Comments

When you pick the Load From Card menu box, the Directory popup menu can appear in one of several forms, according to what, if anything, is stored in the RAM card. The following illustration shows some examples when a 64K-byte RAM card is in use:

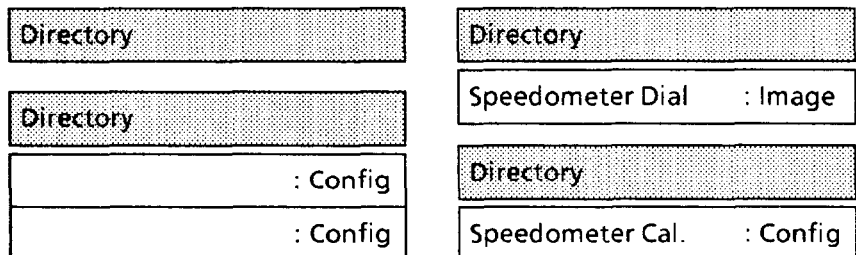

When a 512K-byte RAM card is in use, as many as 16 configurations or 8 camera images could appear under the Directory menu box.

If the Directory menu box appears by itself, the RAM card contains neither a configuration nor an image.

**Selecting Archival Popup
Menu (continued)****Using Load From Card Function (continued)****Your Action**

*Pick the appropriate Config
or Image menu box.*

Comments

When you pick the appropriate menu box, the system will load the configuration or image data from the RAM card. One of the following messages will appear in the message box:

Loading Configuration

or

Loading Image

These messages indicate that configuration or image loading is under way.

After a moment, one of the following messages will appear in the message box:

Configuration Loaded

or

Image Loaded

These messages indicate that the configuration or image loading is finished. You can now remove the RAM card.

Selecting Snapshot Popup Menu

Select the Snapshot popup menu, then select the appropriate image display function.

Your Action

Pick the Snapshot menu box in the Misc popup menu.

Comments

When you pick the Snapshot menu box, the Snapshot popup menu appears above the Misc popup menu, as follows:

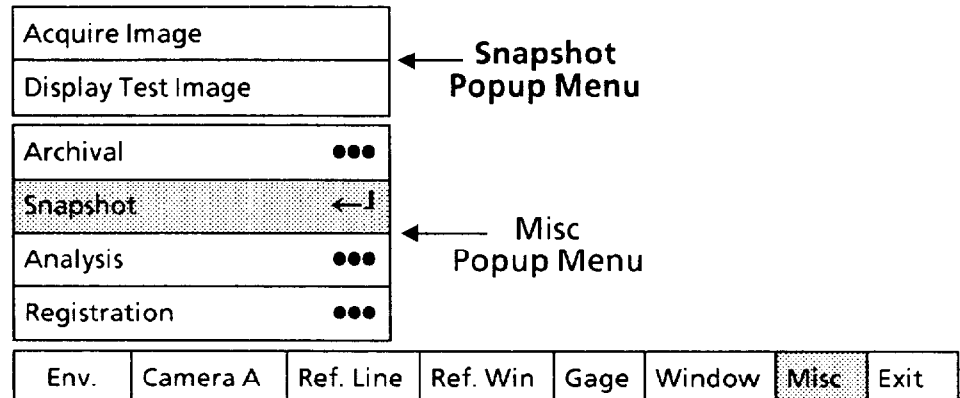

From the top down, these are the functions in the Snapshot popup menu:

- **Acquire Image:** When you pick this function, the CVIM system acquires a *single* camera image.
- **Display Test Image:** When you pick this function, the CVIM system generates and displays the same test image that appears on powerup, but *without* the “banner” message.

Using Acquire Image Function

Select this function to acquire a *single* image from the currently selected camera (that is, camera A or B, whichever appears in the Camera menu box in the Main Configuration menu).

NOTE: The “Setup” trigger source must be enabled. Refer to the trigger source description in Chapter 4, *Operating Environment*.

Your Action

Pick the Acquire Image menu box, if appropriate.

Comments

When you pick the Acquire Image menu box, the CVIM system will acquire a single camera image. Each time you pick this menu box, a “new” image will appear on the screen.

Using Display Test Image Function

Select this function to display the special test pattern image. This function can be useful to familiarize yourself with the operations of the various tools.

NOTE: The test pattern image will *overwrite* the currently displayed camera image.

Selecting Snapshot Popup Menu (continued)

Using Display Test Image Function (continued)

Your Action

Comments

Pick the Display Test Image menu box, if appropriate.

When you pick the Display Test Image menu box, the CVIM system will generate a special image consisting of gray scale bars in the upper half of the image and two binary figures in the lower half.

Note that this is the same image that appears on the screen after powerup.

Selecting Analysis Popup Menu

Select the Analysis popup menu, then select the analysis functions.

Your Action

Comments

Pick the Analysis menu box in the Misc popup menu.

When you pick the Analysis menu box, the Analysis popup menu appears above the Misc popup menu, as follows:

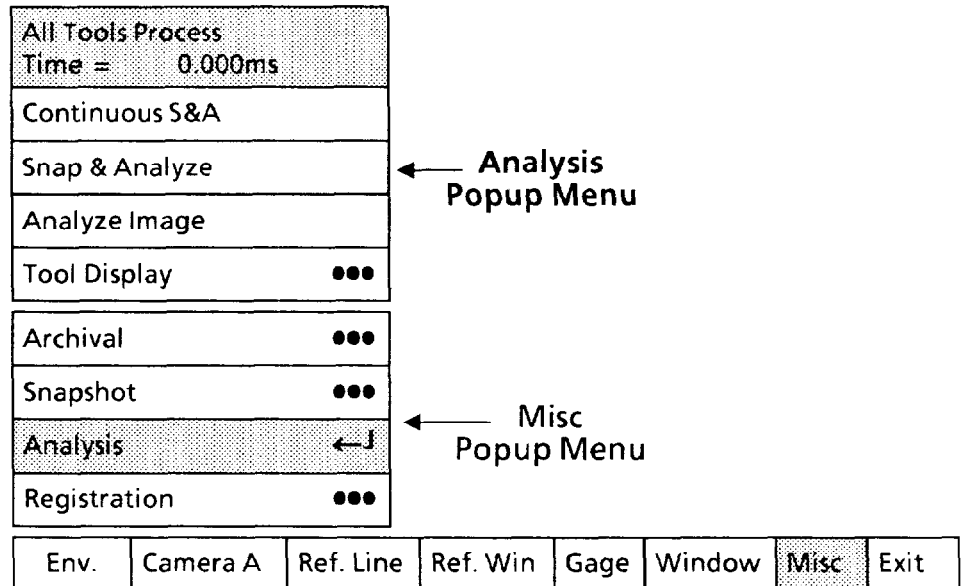

From the top down, these are the functions in the Analysis popup menu:

- **Continuous S&A:** When you pick this function, the CVIM system performs the Snap & Analyze function continuously.
- **Snap & Analyze:** When you pick this function, the CVIM system takes a "snapshot" and displays the processing time for the specified tool(s).
- **Analyze Image:** When you pick this function, the CVIM system displays the processing time for the specified tools using the current stored image.

**Selecting Analysis
Popup Menu (continued)**

Your Action

Comments

● **Tool Display:** When you pick this function, a popup menu appears that enables you specify the particular tool(s) whose processing time you want displayed.

Note that the Analysis menu "header" displays the following information:

● **(Tool) Process and Time = (t)ms:** This indicates the processing time (t) in milliseconds for the specified tool(s).

Using Tool Display Function

Use this function to specify the particular tool(s) whose processing time you want the CVIM system to display.

Your Action

Comments

Pick the Tool Display menu box, if appropriate.

When you pick the Tool Display menu box, the Tool Display popup menu will appear, as follows:

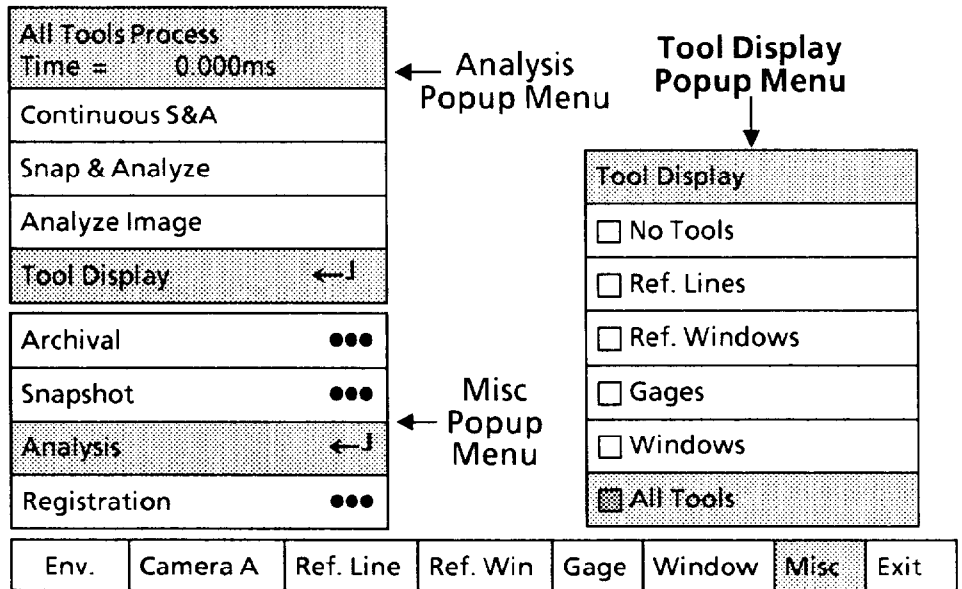

Note that the All Tools box is darkened, indicating that the currently selected tool display mode is All Tools.

Selecting Analysis Popup Menu (continued)

Using Tool Display Function (continued)

Your Action	Comments
<p><i>Pick the appropriate Tool Display menu box.</i></p>	<p>When you pick a Tool Display menu box, The CVIM system performs these functions:</p> <ul style="list-style-type: none"> ● Darkens the selected menu box. ● Displays the processing time for the selected tool(s). ● Displays the selected tool(s) over the image. The color of each tool shows whether it passed or failed the inspection. ● Displays the contents of the selected menu box in the "header" box of the Analysis popup menu. <p>NOTE: When you pick any of the next three analysis functions, you may see some slight variations in the displayed tool processing time. These variations can result from the specific timing of internal processing routines and from synchronization delays.</p> <p>The variations are typically small compared to tool processing times; thus, they should not adversely affect the usefulness these calculations have in helping you to estimate the processing times for your application.</p>

Using Analyze Image Function

Use this function to display the processing time for the *current* camera image.

Your Action	Comments
<p><i>Pick the Analyze Image menu box, if appropriate.</i></p>	<p>When you pick the Analyze Image menu box, the CVIM system uses the <i>current</i> stored camera image to display the inspection processing time, in milliseconds, in the "header" box in the Analysis popup menu.</p>

Using Snap & Analyze Function

Use this function to acquire a new camera image and display the processing time for the tool(s) that you have selected in the Tool Display popup menu.

Your Action	Comments
<p><i>Pick the Snap & Analyze menu box, if appropriate.</i></p>	<p>When you pick the Snap & Analyze menu box, the CVIM system acquires a <i>new</i> camera image (takes a "snapshot"), then displays the inspection processing time, in milliseconds, in the "header" box in the Analysis popup menu.</p>

**Selecting Analysis
Popup Menu (continued)**

Using Continuous S&A Function

Use this function to perform the Snap & Analyze function *continuously*.

Your Action

Pick the Continuous S&A menu box, if appropriate.

Comments

When you pick the Continuous S&A menu box, the CVIM system *continuously* acquires a new camera image (takes a "snapshot") and displays the inspection processing time, in milliseconds, in the "header" box in the Analysis popup menu. Also, the following message appears in the message box on the monitor screen:

Depress the lightpen to continue

The system repeats the "snap and analyze" process about every half second (if the auto/internal trigger source is enabled); however, the actual rate depends on the type and number of tools that are enabled and the trigger selected.

To end the function, use your finger to press light pen tip, or press the tip against the monitor screen. Hold the tip this way until the message box disappears.

**Selecting Registration
Popup Menu**

Select the Registration popup menu, then select the registration functions.

NOTE: In order to make use of this function, you must first configure at least one *reference* tool and then assign the inspection tools to the reference tool.

The Registration function enables you to *automatically* re-align inspection tools with a workpiece when the workpiece has been moved from its original position in the screen image. You can then *save* the shifted tool positions and re-configure them as needed.

Selecting Registration Popup Menu (continued)

Your Action

Pick the Registration menu box in the Misc popup menu.

Comments

When you pick the Registration menu box, the Registration popup menu appears above the Misc popup menu, as follows:

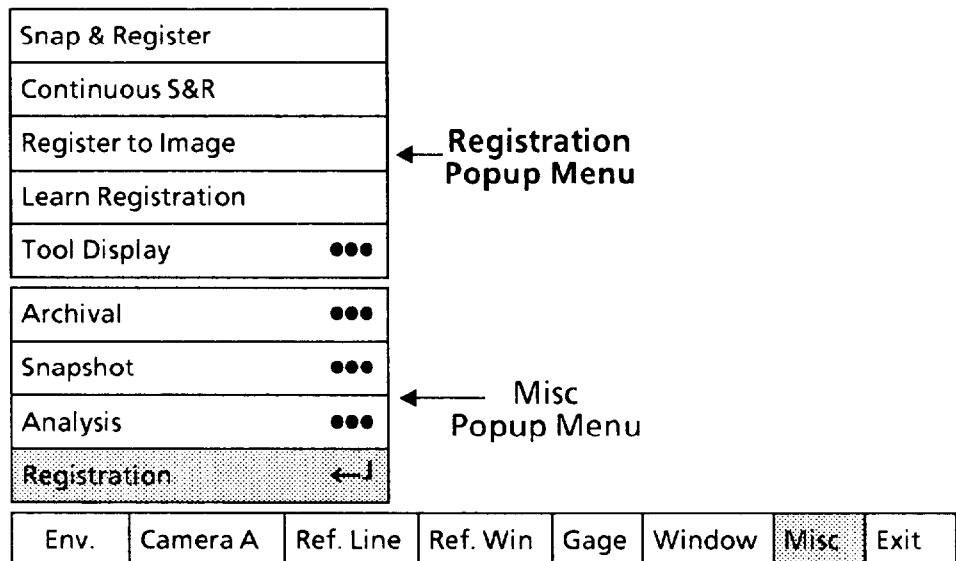

From the top down, these are the functions in the Registration popup menu:

- **Snap & Register:** When you pick this function, the CVIM system takes a “snapshot” and re-registers the tools to the new location of the workpiece in the screen image.
- **Continuous S&R:** When you pick this function, the CVIM system will perform the Snap & Register function continuously.
- **Register to Image:** When you pick this function, the CVIM system registers the tools using the current stored image.
- **Learn Registration:** When you pick this function, the CVIM system stores or “learns” the re-registered positions of the tools.
- **Tool Display:** When you pick this function, a Tool Display popup menu appears. This menu enables you specify the particular tool(s) that you want the system to display.

**Selecting Registration
Popup Menu (continued)**

Using Tool Display Function

Use this function to specify the particular tool(s) that you want the CVIM system to display during the Snap & Register, Continuous S & R, and Register to Image functions.

Tool displays are *color coded* to indicate the *outcome* of the Snap & Register, Continuous S & R, or Register to Image function. The colors have the following meanings:

● Reference tools:

Green means that the reference tool found its selected feature.

Yellow means that the reference tool did *not* find its selected feature.

Red means that the reference tool is assigned to *another* reference tool, and *that* reference tool did not find its selected feature.

● Inspection tools:

Green means *only* that the inspection tool could be properly positioned within the screen image.

Yellow means that the inspection tool was positioned off the screen image.

Red means that the inspection tool could *not* be positioned because the reference tool to which it is assigned could *not* find its selected feature.

Your Action

Pick the Tool Display menu box, if appropriate.

Comments

When you pick the Tool Display menu box, the Tool Display popup menu will appear, as follows:

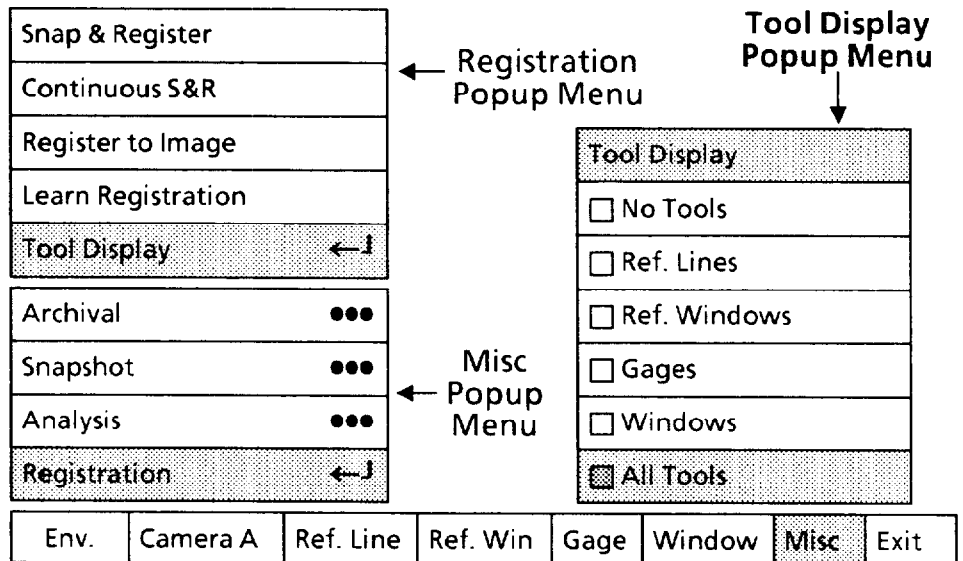

**Selecting Registration
Popup Menu (continued)****Using Tool Display Function (continued)****Your Action**

*Pick the appropriate Tool
Display menu box.*

Comments

Note that the All Tools box is darkened, indicating that the currently selected tool display mode is All Tools.

When you pick a Tool Display menu box, The CVIM system performs darkens the selected menu box and displays the selected tool(s) over the image.

Using Snap & Register Function

Use this function to acquire a new camera image and register all inspection tools that you have assigned to reference tools.

Your Action

*Pick the Snap & Register
menu box, if appropriate.*

Comments

When you pick the Snap & Register menu box, the CVIM system performs these tasks:

- It acquires a new camera image (takes a "snapshot").
- It analyzes the enabled reference tools.
- It re-registers the inspection tools to their assigned reference tools.
- It displays the tool(s) locations on the screen.

Using Continuous S&R Function

Use this function to perform the Snap & Register function *continuously*.

Your Action

*Pick the Continuous S&R
menu box, if appropriate.*

Comments

When you pick the Continuous S&R menu box, the CVIM system *continuously* acquires a new camera image (takes a "snapshot"), registers the inspection tools to their assigned reference tools, and displays the new tool locations on the monitor screen. Also, the following message appears in the message box on the monitor screen:

Depress the lightpen to continue

The system repeats the "snap and register" process about every half second (if the auto/internal trigger source is enabled); however, the actual rate depends on the type and number of tools that are enabled and the trigger selected.

To end the function, use your finger to press light pen tip, or press the tip against the monitor screen. Hold the tip this way until the message box disappears.

**Selecting Registration
Popup Menu (continued)****Using Register to Image Function**

Use this function to register the tools using the *current* screen image.

Your Action

Pick the Register to Image menu box, if appropriate.

Comments

When you pick the Register to Image menu box, the CVIM system uses the *same* stored camera image to register the inspection tools to the workpiece.

Using Learn Registration Function

Use this function to “learn” the new tool locations if you want to *modify* the tool configurations in these locations.

Your Action

Pick the Learn Registration menu box, if appropriate.

Comments

When you pick the Learn Registration menu box, the CVIM system *stores* the locations of the re-registered inspection, and thereby alters the previous configuration of these tools.

NOTE: Window *rotation* cannot be “learned” for rectangular and elliptical windows. Only *shift* can be learned.

Chapter 10 Runtime Functions

Chapter Objectives

This chapter shows you how to select and use the runtime functions in the Exit popup menu. This menu appears when you pick the Exit menu box in the Main Configuration menu.

Runtime Functions: Overview

The term “runtime functions” refers to the tasks that relate directly to the *run mode* – the mode during which the CVIM system performs inspections and reports inspection results.

Runtime functions include these main tasks:

- *Initializing* the counters, output lines, freeze and halt functions, and operating mode.
- *Arming* a freeze or halt function.
- *Selecting* the tool set and display that will appear when run mode begins.
- *Selecting* the run mode itself – this enables an inspection operation.

All of these functions are in the Exit popup menu, which you can access after picking the Exit menu box in the Main Configuration menu.

Using Runtime Functions

This remainder of this chapter shows you the details of selecting and using the runtime functions.

You will pick the Exit menu box in the Main Configuration menu, then select one of the runtime functions.

Selecting Exit Popup Menu

Your first step is to select the Exit popup menu.

Your Action

Pick Exit in the Main Configuration menu.

Comments

When you pick the Exit menu box, the Exit popup menu appears above the Main Configuration menu, as follows:

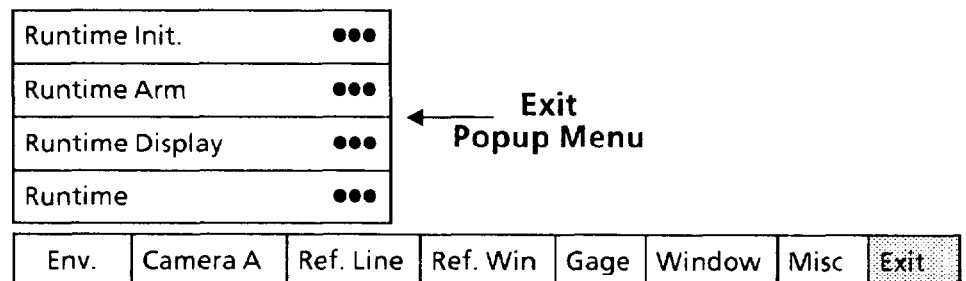

The menu boxes correspond to the functions described in the overview: Runtime Init., Runtime Arm, Runtime Display, and Runtime.

Selecting Runtime Init. Popup Menu

Select the Runtime Init. popup menu, then select the appropriate runtime *initialization* function.

Your Action

Pick the Runtime Init. menu box in the Exit popup menu.

Comments

When you pick the Runtime Init. menu box, the Runtime Init. popup menu appears above the Exit popup menu, as follows:

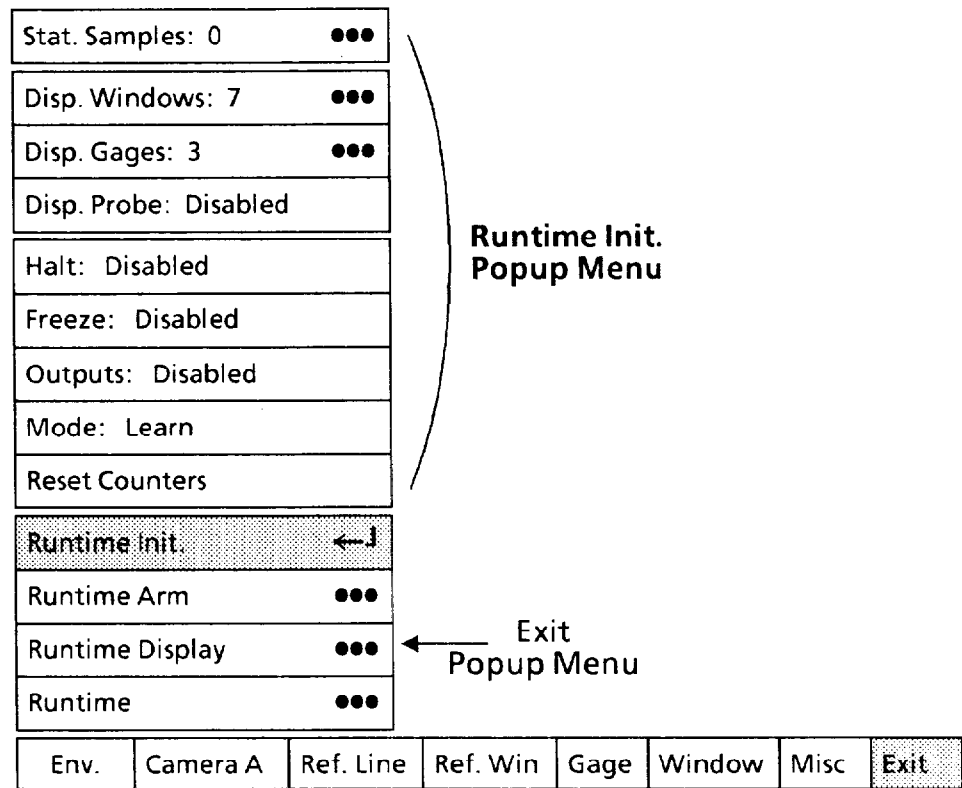

From the top down, these are the initialization functions in the Runtime Init. popup menu:

- **Stat. Samples:** When you pick this menu box, you can configure the statistics pages (Stat. Page 1 and Stat. Page 2) to display the accumulated inspection results from a *specified number* of sample inspections.

For example, if you specify “50,” the statistics pages will display the *accumulated* inspection results for each series of 50 inspections. The statistics pages will be updated at the end of each series of 50 inspections, but they will display *only* the results accumulated from the immediately preceding series of 50 inspections.

- **Disp. Windows:** When you pick this menu box, you can specify the number of *windows* whose inspection results are to be displayed in the Results Page and in Stat. Page 1.

- **Disp. Gages:** When you pick this menu box, you can specify the number of *gages* whose inspection results are to be displayed in the Results Page and in Stat. Page 1.

Selecting Runtime Init. Popup Menu (continued)

Your Action

Comments

- **Disp Probe:** When you pick this menu box, you either enable or disable *displaying the light probe data* in the Results Page and in Stat Page 1. The Disp Probe status is either Enabled or Disabled.

- **Halt:** When you pick this menu box, you either enable or disable the halt-on-reject function during the run mode. When *armed*, this function causes the CVIM system to *freeze* the last image and *halt* inspection operations upon detecting *any* reject condition. (You can *resume* inspection operations by picking the Resume menu box in the runtime menu.) The Halt status is either Enabled or Disabled.

- **Freeze:** When you pick this menu box, you either enable or disable the three “freeze” functions during the run mode. When *armed*, these functions cause the CVIM system to *freeze the last image* when the selected freeze condition is met. The system *continues* inspection operations. (You can *resume* live image displays by picking the Resume menu box in the runtime menu.) The Freeze status is either Enabled or Disabled.

These are the three freeze conditions: Freeze on first reject, freeze on all rejects, and freeze on the next inspection.

- **Outputs:** When you pick this menu box, you either enable or disable signal outputs to the discrete output lines. This function determines whether or not the CVIM system can send signals to the assigned output lines. The Outputs status is either Enabled or Disabled.

- **Mode:** When you pick this menu box, you select either the *standard* operating mode or the *learn* operating mode.

The main difference is this: When the CVIM system is in the *learn* operating mode, it gathers statistical information from each inspection cycle. You can use these statistics during configuration to help you determine tool range parameters and analyze system operation. During the run mode, you can watch these statistics accumulate in real time on one of the statistics display “pages.” Using the learn mode increases processing time slightly.

In the *standard* operating mode, the system does not accumulate and display statistics. It does, however, display inspection results.

- **Reset Counters:** When you pick this menu box *prior to starting the run mode*, the statistical and pass/fail counters are reset, along with the values in the statistics displays.

In the next several steps, configure the status of each Runtime Init. function according to your needs.

Selecting Runtime Init. Popup Menu (continued)

Selecting Halt Status

The halt status determines whether the halt-on-reject function can be *armed* to halt an inspection operation when a reject condition (that is, an inspection failure) occurs from *any* cause.

Note that after you set the Halt status to *enable*, you must *arm* the halt-on-reject function, using the Runtime Arm popup menu or the Arm menu box in the Run Mode menu. This is described later.

Your Action

Comments

Look at the Halt menu box.

The Halt menu box shows the current status of the halt function: Enabled or Disabled.

Pick the Halt menu box, if appropriate.

If you need to change the Halt status from Enabled to Disabled, or vice versa, pick the Halt menu box *once*. (If you pick this box repeatedly, the status will *toggle* between Enabled and Disabled.)

Selecting Freeze Status

The freeze status determines whether the freeze functions can be armed to freeze an image when one of the three freeze conditions is met. In all cases, inspection operations will continue.

The three freeze conditions are these:

- Freeze on 1st reject – The screen image will freeze when the first reject-causing condition occurs (such as a window pixel count being outside range limits).
- Freeze on *all* rejects – The screen image will freeze *whenever* a reject-causing condition occurs. The frozen image will remain until the *next* reject condition occurs.
- Freeze on the next inspection - The screen image will freeze after the next inspection cycle, regardless of whether a reject-causing condition has occurred. The frozen image will remain until you pick the Resume or Go on Reject menu box, or pick another freeze function.

Note that after you set the Freeze status to *enable*, you must *arm* the specific freeze function, using the Runtime Arm popup menu or the Arm menu box in the Run Mode menu. This is described later.

Your Action

Comments

Look at the Freeze menu box.

The Freeze menu box, shows the current status of the freeze function: Enabled or Disabled.

Pick the Freeze menu box, if appropriate.

If you need to change the current status of the freeze functions from Enabled to Disabled, or vice versa, pick the Freeze menu box *once*. (If you pick this box repeatedly, the status will *toggle* between Enabled and Disabled.)

**Selecting Runtime Init.
Popup Menu (continued)****Selecting Output Line Status**

The output line status determines whether the 14 discrete output lines are *enabled* or *disabled* for sending signals to your production equipment. When the output lines are enabled and the CVIM system is performing inspections, the signal that appears on any *particular* output line depends on both the inspection results and the function you assigned to that line.



WARNING: The output lines should *not* be enabled or connected to your production equipment while you are developing and testing your CVIM configurations. Otherwise, an unpredictable and possibly dangerous reaction in your equipment may cause injury to personnel.

Your Action

Look at the Outputs menu box.

Pick the Outputs menu box, if appropriate.

Comments

The Outputs menu box shows the current status of the output-line function: Enabled or Disabled.

If you need to change the current status of the output-line function from Enabled to Disabled, or vice versa, pick the Outputs menu box *once*. (If you pick this box repeatedly, the status will toggle between Enabled and Disabled.)

Selecting Operating Mode Status

The operating mode status determines whether the CVIM system will operate in the *learn* operating mode or the *standard* operating mode. The main difference is that in the learning mode the system accumulates and displays statistics on the basis of inspection results. You can use these statistics during configuration for setting tool range limits.

In the standard mode, the CVIM system does *not* accumulate and display statistics. You would normally operate the system in this mode after configuration is complete and the system is in production use.

Your Action

Look at the Mode menu box.

Pick the Mode menu box, if appropriate.

Comments

The Mode menu box shows the current status of the CVIM system operating mode.

If you need to change the system operating mode from Standard to Learn, or vice versa, pick the Mode menu box *once*. (If you pick this box repeatedly, the status will toggle between Enabled and Disabled.)

Selecting Runtime Init. Popup Menu (continued)

Selecting Reset Counters Function

The Reset Counters function resets the counters and other data in the Results, Stat Page 1, and Stat Page 2 display pages, which are described later in this chapter. It also resets the data in all of the inspection statistics table for each inspection tool (these tables appear when you assign range limits and output lines).

Note that the CVIM system tabulates and displays statistics *only* when it is in the *learn* operating mode.

Your Action

Pick the Reset Counters menu box, if appropriate.

Comments

When you pick Reset Counters, the counters and data in the tables are reset to zeros.

Selecting Runtime Arm Popup Menu

Select the Runtime Arm popup menu, then select the appropriate halt or freeze function to be "armed" during run mode operations.

The main function of the Runtime Arm popup menu is to enable you to "arm" the halt or freeze function that you enabled in the Runtime Init. popup menu.

Your Action

Pick the Runtime Arm menu box in the Exit popup menu.

Comments

When you pick the Runtime Arm menu box, the Runtime Arm popup menu appears above the Exit popup menu, as follows:

The screenshot shows a vertical menu with the following items:

- Go on Reject
- Freeze 1st Rej
- Freeze All Rejs (shaded)
- Freeze Next Insp
- Halt on Reject
- Runtime Init. ●●●
- Runtime Arm ← (shaded)
- Runtime Display ●●●
- Runtime ●●●

 An arrow labeled "Runtime Arm Popup Menu" points to the "Freeze All Rejs" option. Another arrow labeled "Exit Popup Menu" points to the "Runtime Arm" option. Below this menu is a horizontal bar with buttons: Env., Camera A, Ref. Line, Ref. Win, Gage, Window, Misc, and Exit. The "Exit" button is shaded.

Note that the Freeze All Rejs box in the menu is shaded and has a filled square (☑). This indicates that for *any* reject that occurs during runmode operations, the image with the reject-causing condition will "freeze," but inspections will continue.

**Selecting Runtime Arm
Popup Menu (continued)**

Your Action	Comments
<i>Pick the appropriate freeze or halt function to be armed.</i>	You can arm a freeze or halt function <i>only</i> if you enabled it in the Runtime Init. popup menu.

**Selecting Runtime Display
Popup Menu**

Select the Runtime Display popup menu, then select the appropriate runtime display function.

The main function of the Runtime Display menu is to enable you to select the "default" display that you want to appear on the monitor screen *when you start the run mode*. After the run mode begins, you can change the display.

Your Action	Comments
<i>Pick the Runtime Display menu box in the Exit popup menu.</i>	When you pick the Runtime Display menu box, the Runtime Display popup menu appears above the Exit popup menu, as follows:

The image shows two overlapping popup menus. The top menu, labeled "Runtime Display Popup Menu", contains the following items: "Tool Set: 1", "Image Only", "Failed Tools", "All Tools", "I/O Page", "Results Page" (which is shaded and has a filled square next to it), "Stat. Page 1", and "Stat. Page 2". The bottom menu, labeled "Exit Popup Menu", contains: "Runtime Init.", "Runtime Arm", "Runtime Display" (shaded and has a filled square next to it), and "Runtime". Below the Exit menu is a toolbar with buttons: "Env.", "Camera A", "Ref. Line", "Ref. Win", "Gage", "Window", "Misc", and "Exit".

Note that the Results Page box in the menu is shaded and has a filled square (◻). This indicates that Results Page is the current display selection. Thus, at the start of the run mode, the monitor screen will display the results page for the tool set number shown in the Tool Set menu box. (No data will appear, however, until triggers are received.)

**Selecting Runtime Display
Popup Menu (continued)**

Here is a brief description of the menu boxes in the Runtime Display popup menu:

- **Tool Set:** This box shows the currently selected tool set number. This tool set applies to all of the remaining selections in the Runtime Display menu. When you pick this box repeatedly, the tool set number toggles between 1 and 2.
- **Image Only:** When you pick this box, only the camera image (and run mode menu) will appear on the monitor screen.
- **Failed Tools:** When you pick this box, during the run mode the monitor screen will display only the *enabled* tools in the currently selected tool set whose "results" exceed a warning or fault limit.
- **All Tools:** When you pick this box, during the run mode the monitor screen will display *all* enabled tools in the currently selected tool set.
- **I/O Page:** When you pick this box, the I/O page will appear on the monitor screen at the start of the run mode. The I/O page shows the "pass/fail" condition of all *enabled* tools assigned to output lines having "results" and Master Range function assignments. Separately, the I/O page also shows the "pass/fail" condition of each *enabled* tool in the currently selected tool set.
- **Results Page:** When you pick this box, the Results page will appear on the monitor screen at the start of the run mode. The results page shows the tool measurement readings and any faults that may occur during each inspection cycle.
- **Stat. Page 1:** When you pick this box, the Stat 1 page will appear on the monitor screen at the start of the run mode. The Stat 1 page shows statistics for the light probe, gages, and windows resulting from each inspection cycle *while the CVIM system is in the learn operating mode*.

When the system is in the *standard* operating mode, the Stat 1 and Stat 2 pages cannot be selected.

- **Stat. Page 2:** This functions the same as the Stat 1 page, except it shows statistics for the reference windows *only*.

Pick the appropriate runtime tool set and display selection.

If appropriate, change the tool set number and/or pick a different display selection. When you activate the run mode, this display selection will appear automatically on the monitor screen.

**Selecting Runtime
Popup Menu**

Select the Runtime popup menu, then select either the run mode function to start an inspection operation, or select the Save Config. (Int) function to store the current configuration in the CVIM module's EEPROM.

Your Action

Pick the Runtime menu box in the Exit popup menu.

Comments

When you pick the Runtime menu box, the Runtime popup menu appears above the Exit popup menu, as follows:

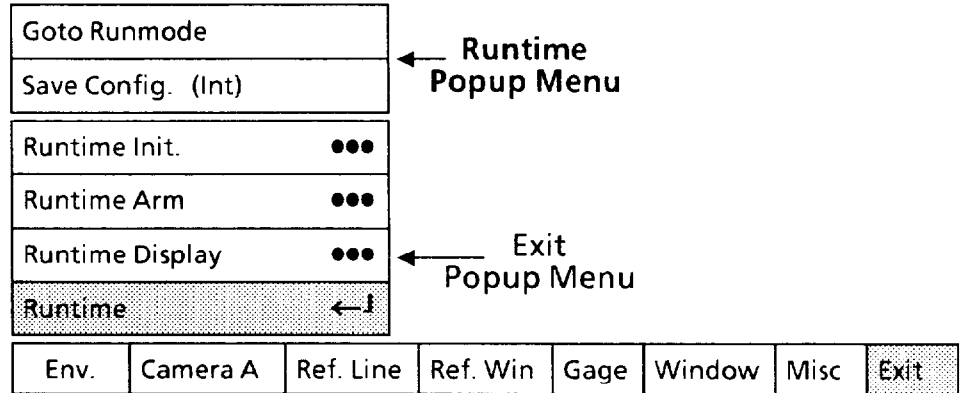

Selecting Save Config. (Int) Function

Select the Save Config. (Int) function to store the current configuration in CVIM system EEPROM. This function operates the same as the Save Config. (Int) function described in Chapter 9, *Configuration Aids and Storage*.

Your Action

Pick the Save Config. (Int) menu box, if appropriate.

Comments

When you pick the Save Config. (Int) menu box, the CVIM system will *store* the current configuration in the EEPROM. The following message appears in the message box in the upper part of the monitor screen:

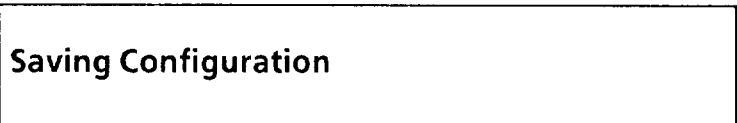

This indicates that configuration storage is under way.

NOTE: If a power interruption occurs here, configurations in both the CVIM system EEPROM *and* RAM will be lost.

After a moment, the following message appears in the message box:

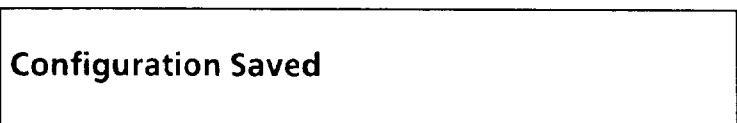

This indicates that configuration storage is finished.

Selecting Goto Runmode Function

Select the Goto Runmode to set the CVIM system to the run mode.

Note that the CVIM system will not actually perform an inspection operation until it receives a trigger signal. The *trigger source* that you set earlier (Chapter 4, *Operating Environment*) will determine the system's response when you select the Goto Runmode function.

Thus, if you have selected Auto/Internal as the runtime trigger source, the system will immediately begin performing inspections. If you have selected the I/O (discrete) or hosted trigger source, the system will wait until it receives a trigger signal from the I/O or host source before it performs an inspection. It will perform *one* inspection per trigger signal.

Your Action

Pick the Goto Runmode menu box to start an inspection operation.

Comments

When you pick the Goto Runmode menu box, the CVIM system will enter the run mode, and the Run Mode menu will appear at the bottom of the screen, as follows:

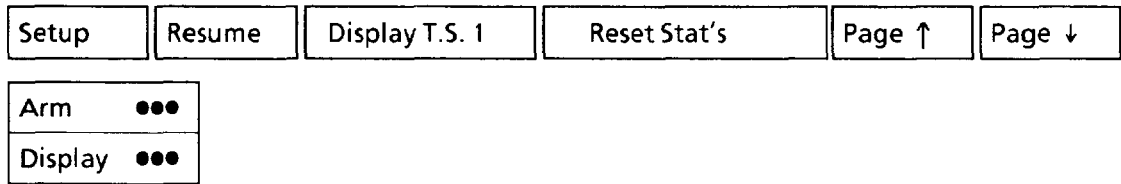

In addition to the Run Mode menu, the display selection that you picked earlier in the Runtime Display popup menu will appear on the screen above the menu. The contents of these display selections are explained in detail in the following section.

If you want to *change* the display after the run mode begins, you can do so by picking the Display menu box in the Run Mode menu, as follows:

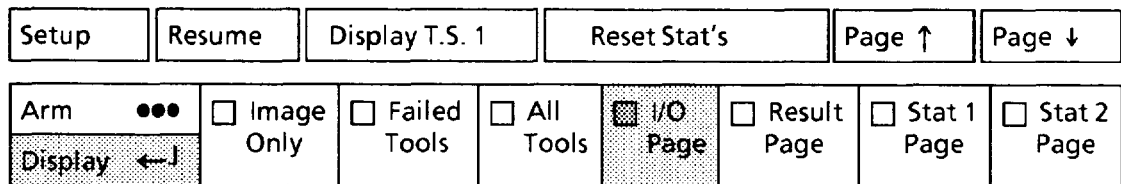

Note that the seven display selections appear in boxes alongside the Display menu box. The I/O Page selection is darkened, indicating that the I/O Page is the currently selected display appearing on the monitor screen.

To change to another display selection, simply pick the box with that selection. The current selection (I/O Page, in this example) will be replaced by the new selection.

Interpreting Run Mode Displays

At the start of the run mode, the monitor screen displays the camera image and Run Mode menu either alone or in combination with either tool symbols or a display page. The *specific* symbol(s) or table appearing on the screen depends, as shown earlier, on which display selection you picked in the Runtime Display popup menu.

NOTE: Tool *processing* takes precedence over tool *display*. Thus, although all tools are *processed*, in certain high-speed applications, some tools may not always be displayed.

These symbols and display pages show, in various forms, the results of each inspection operation *for the currently selected tool set*.

Here is a detailed description of these symbols and display pages:

Image Only

If you picked this display selection, only the camera image and Run Mode menu appear on the monitor screen. You may want to use this selection to view the complete camera image.

Failed Tools

This display selection shows the camera image and the enabled analysis tools (except the light probe) that *fail* an inspection will appear on the screen. These are the tools whose inspection “results” are outside one of the warning or fault range limits that you set during configuration.

On a color monitor, the tools whose results exceed a fault limit appear in *red*. The tools whose results exceed a warning limit *only* appear in *yellow*.

All Tools

This display selection shows the camera image and *all* enabled analysis tools (except the light probe). This applies whether the tools pass or fail the inspection.

On a color monitor the tools that *pass* an inspection appear in *green*. These are the tools whose inspection results are within both the fault and the warning range limits.

The tools that *fail* an inspection appear in *red*. These are the tools whose inspection results are outside one of the fault range limits.

The tools whose results are outside one of the *warning* range limits, but are within both *fault* range limits appear in *yellow*.

Interpreting Run Mode I/O Page Displays (continued)

If you picked the I/O Page display selection, the I/O Page will appear on the screen when you start the run mode:

INSPECTION RESULT OUTPUTS Disabled/forced				LIGHT PROBE	REFERENCE LINES / WINDOWS	
1.	5.	9.	13. +			1.
2.	6.	10.	14. -		2.	2.
3.	7.	11.			3.	3.
4.	8.	12.				
GAGES				WINDOWS		
1.	9.	17.	25.	1.	9.	17.
2.	10.	18.	26.	2.	10.	18.
3.	11.	19.	27.	3.	11.	19.
4.	12.	20.	28.	4.	12.	20.
5.	13.	21.	29.	5.	13.	21.
6.	14.	22.	30.	6.	14.	22.
7.	15.	23.	31.	7.	15.	23.
8.	16.	24.	32.	8.	16.	24.

The I/O Page is a table that summarizes the inspection "results" for all *enabled* analysis tools in whichever tool set is currently selected. These appear in the GAGE, WINDOWS, LIGHT PROBE, and REFERENCE LINES / WINDOWS blocks. The table uses color blocks (color monitor) or letters and words (monochrome monitor) to indicate the "pass/warning/fail" status of the inspection results.

In the INSPECTION RESULT OUTPUTS block, the I/O Page shows the "pass/fail" status of each "results" output line to which an *enabled* analysis tool is assigned. The I/O page also shows the "pass/fail" status of the Master Range signal if it is assigned to an output line.

Appearing directly under the INSPECTION RESULT OUTPUTS heading is the status of the output lines. This can take one of the following forms:

- *No message* – The output lines are *enabled*.
- *Disabled* – The output lines are *disabled*.
- *Forced* – The output lines are *enabled*, but some may be forced to either the "on" or the "off" state by a host system. The lines that are forced "on" have a *plus (+)* sign (see line 13 in the figure above). The lines that are forced "off" have a *minus (-)* sign (see line 14).
- *Disabled/forced* – The output lines are *disabled*, but some may be forced to either the "on" or the "off" state. (The "forced" condition takes precedence over the "disabled" condition.)

Interpreting Run Mode Displays (continued)

I/O Page (continued)

In all of the above cases, the *appearance* of the inspection results (the color blocks or words and letters) *may not reflect the output line status*.

The I/O Page is updated at the end of each inspection, *time permitting*.













NOTE 1: Since *more than one tool* can be assigned to a particular output line, that line will indicate an "off" condition *only if all* tools assigned to it pass inspection. If one tool fails inspection, the output line will indicate an "on" condition *regardless* of whether the other tools pass or fail.

NOTE 2: The I/O Page indicates only the "results" for analysis tools. It does *not* show signals from strobe, trigger NAK, data valid, or module busy conditions.

On a *color* monitor screen, the I/O Page uses small colored blocks to indicate inspection results for the analysis tools and output lines, as follows:

- *Green* blocks indicate a *pass* condition for tools and an *off* condition for the output lines.
- *Red* blocks indicate a *fail* condition for tools and an *on* condition for the output lines.
- *Yellow* blocks indicate a *warning* condition for the light probe, gages, and windows only. They do not apply to reference tools and output lines.

The color blocks appear as shown in the following example of a *color* I/O Page:

INSPECTION RESULT OUTPUTS				LIGHT PROBE	REFERENCE LINES / WINDOWS		
1.		5.				1.	1.
2.		6.			2.	2.	
3.		7.			3.	3.	
4.		8.	12.				
GAGES				WINDOWS			
1.		9.	17.	25.	1.	9.	17.
2.		10.	18.	26.	2.	10.	18.
3.		11.	19.	27.	3.	11.	19.
4.		12.	20.	28.	4.	12.	20.
5.		13.	21.	29.	5.	13.	21.
6.		14.	22.	30.	6.	14.	22.
7.		15.	23.	31.	7.	15.	23.
8.		16.	24.	32.	8.	16.	24.

**Interpreting Run Mode
Displays (continued)****I/O Page (continued)**

Output lines 1, 2, and 4 are “green,” indicating an “off” condition. This means that the tool inspection results connected to these lines are *within* their respective range limits.

Output lines 3, 5, and 6 are “red,” indicating an “on” condition. This means that the tool inspection results connected to these lines are *outside* one of their respective range limits. Note that a tool whose inspection results are outside a *warning* range limit causes a “red” output line indication.

Gages 1, 2, and 4 are “green,” indicating that the inspection results for these gages are within both the *warning* and the *fault* limits.

Gage 3 is “yellow,” indicating that the inspection results for this gage are within the *fault* limits, but *outside* one of the *warning* limits.

Gages 5 and 7 are “red,” indicating that the inspection results for this gage are outside both the *fault* limits and the *warning* limits.

NOTE: The I/O Page does *not* show how the tools are assigned to the output lines; thus, you cannot determine by looking *only* at the I/O Page whether output lines 1, 2, and 4 correspond to gages 1, 2, and 4, or whether output lines 3, 5, and 6 correspond to gages 3, 5, and 6. To determine the gage-to-output line assignments, you will need to look at the output line assignments for each gage.

On a *monochrome* monitor screen, the I/O Page uses letters and words to indicate inspection results for the analysis tools and output lines, as follows:

- Upper case P indicates a *pass* condition for all tools.
- Upper case F indicates a *fail* condition for all tools.
- Upper case W indicates a *warning* condition for the light probe, gages, and windows.
- The words Off and On indicate the condition of the output lines.

Interpreting Run Mode I/O Page (continued)
Displays (continued)

The words and letters appear as shown in the following example of a *monochrome* I/O Page:

INSPECTION RESULTS OUTPUTS				LIGHT PROBE	REFERENCE LINES / WINDOWS	
Disabled					1.	1.
1. Off	5. On	9.	13.		2.	2.
2. Off	6. On	10.	14.		3.	3.
3. On	7.	11.				
4. Off	8.	12.				
GAGES				WINDOWS		
1. P	9.	17.	25.	1.	9.	17.
2. P	10.	18.	26.	2.	10.	18.
3. W	11.	19.	27.	3.	11.	19.
4. P	12.	20.	28.	4.	12.	20.
5. F	13.	21.	29.	5.	13.	21.
6. F	14.	22.	30.	6.	14.	22.
7.	15.	23.	31.	7.	15.	23.
8.	16.	24.	32.	8.	16.	24.

Output lines 1, 2, and 4 are "off." This means that the inspection results to these lines are from tools that have *passed* their inspections.

Output lines 3, 5, and 6 are "on." This means that the inspection results to these lines are from tools that have either *failed* their inspections or have a *warning* condition. Note that a *warning* condition from a tool causes an "on" output line indication.

Gages 1, 2, and 4 show a "P," indicating that the inspection results for these gages are within both the *warning* and the *fault* limits.

Gage 3 shows a "W," indicating that the inspection results for this gage are within the *fault* limits, but outside one of the *warning* limits.

Gages 5 and 7 shows a "F," indicating that the inspection results for this gage are outside one of the *fault* limits.

As was stated in the preceding NOTE, the I/O Page does *not* show how the tools are assigned to the output lines.

Interpreting Run Mode Results Page Displays (continued)

If you picked the Results Page display selection, the Results Page will appear on the screen when you start the run mode, as follows:

TRIGGERS		FAULTS		Reference Lines / Windows			
Accepted:	123456	Master Fault:	12	1.	2	1.	1
Missed:	0	Light Probe:	1	2.		2.	
Total:	123456			3.		3.	
GAGE	Faults	Fail Low	Warn Low	Reading	Warn Hi	Fail Hi	
1.	1	130.000	140.000	150.187	160.000	170.000	
2.	12	25.000	28.000	32.354	34.000	37.000	
3.							
4.							
WINDOW	Faults	Fail Low	Warn Low	Reading	Warn Hi	Fail Hi	
1.	1	3000.000	3100.000	3214.485	3300.000	3400.000	
2.							
3.							

The Results Page is a table that summarizes inspection results for all *enabled* analysis tools for whichever tool set is currently selected.

The Results Page is updated at the end of each inspection, *time permitting*.

The TRIGGER section shows the total number of trigger signals received; and of those, the number that the system was able to process and the number that it could *not* process.

Typically, the CVIM system will miss a trigger if the trigger appears *before* the system is finished processing data from the last trigger.

The FAULT section shows the accumulation of faults from the light probe and any of the reference or inspection tools. In the example page above, the light probe has 1 fault and the master fault has 12 faults (this is from gage 1).

The *absence* of numbers next to reference lines 2 and 3 and reference windows 2 and 3 indicate that these tools are not enabled. This also applies to gages and windows.

The GAGE and WINDOW sections show the accumulation of faults, the low and high range limits that you set for each tool, and the "reading" or measurement from the current inspection. On the color monitor, the readings appear in green, red, or yellow, indicating a pass, fail, or warning condition.

**Interpreting Run Mode
Displays (continued)**

Results Page (continued)

Note that in the GAGE section and WINDOW section above, only gages 1 to 4 and windows 1 to 3 are shown. You can display the results for the remaining gages and windows by picking the Page ↓ (page down) menu box in the Runtime menu. This will scroll the page so that you will now see the results for gages 5 - 8 and windows 4 - 6. Pick Page ↓ again and gages 9 - 12 and windows will appear. You can repeat this process until gages 29 - 32 and windows 22 - 24 appear.

To reverse the page scroll, pick the Page ↑ (page up) menu box.

NOTE: The Page ↓ menu box has additional functions. When you pick the Page ↓ box successively, reference tool data will appear in the FAULT block as shown in the following figures.

After the first page-down, the "fault" block appears as follows :

TRIGGERS		Reference Line Readings				
Accepted:	123456	1.X:	157	2.X:		3.X:
Missed:	0	Y:	203	Y:		Y:
Total:	123579	θ:	88.33°	θ:		θ:
GAGE	Faults	Fail Low	Warn Low	Reading	Warn Hi	Fail Hi
5.						
6.						
7.						
8.						
WINDOW	Faults	Fail Low	Warn Low	Reading	Warn Hi	Fail Hi
4.						
5.						
6.						

The block now displays "readings" ("results" data) from all *enabled* reference lines. This data consists of the X and/or Y coordinates of the selected "feature" (edge or midpoint).

Note that the gage and window numbers have advanced to the next level.

Interpreting Run Mode Displays (continued) **Results Page (continued)**

After the second page-down the block appears as follows:

TRIGGERS		Reference Window Readings				
Accepted:	123456	1.1 X: 362	1.2 X: 378	1.3 X: 212	Σ X: 317	
Missed:	0	Y: 106	Y: 380	Y: 213	Y: 233	
Total:	123579	S: 4	S: 2	S: 2	θ : 62.58°	
GAGE	Faults	Fail Low	Warn Low	Reading	Warn Hi	Fail Hi
	9.					
	10.					
	11.					
	12.					
WINDOW	Faults	Fail Low	Warn Low	Reading	Warn Hi	Fail Hi
	7.					
	8.					
	9.					

The block now displays the "readings" ("results" data) from each *active* feature in an *enabled* reference window #1. (No data appears for *inactive* features or *disabled* windows.)

The results data in the columns labeled "1.1," "1.2," and "1.3" consists of the X and Y coordinates of the *upper-left corner(s)* of the *feature* window(s) and the "score" value (S). The results data in the column labeled " Σ " consists of the X and Y coordinates of the shift reference point and the angle (θ) of the rotation reference line (these are described in Chapter 6 under the *Using Learn Function* heading in the *Reference Windows* section.)

Note that the gage and window numbers have advanced to their next levels.

The third and fourth page-downs display the same type of information: They advance the gage and window numbers and display the results for reference windows #2 and #3, respectively.

Subsequent page-downs return the block to the FAULT display and advance the gage and window numbers. The page-down function remains active until the *last* window or gage number appears.

Interpreting Run Mode Stat 1 Page Displays (continued)

If you picked the Stat 1 Page display selection, the Stat 1 Page will appear on the screen when you start the run mode, as follows:

GAGE	Samples	Mean	Std. Dev.	Min. Reading	Max. Reading
1.	123	37.287	1.348	36.413	39.293
2.	123	145.395	5.386	141.165	148.223
3.					
4.	123	6.000	0.000	6.000	6.000

WINDOW	Samples	Mean	Std. Dev.	Min. Reading	Max. Reading
1.	123	3245.245	32.399	3221.476	3278.243
2.	123	181.662	3.542	179.198	183.421
3.	123	11.000	0.000	11.000	11.000
4.					

The Stat 1 Page is a table that summarizes inspection results for all *enabled* gages and windows in whichever tool set is currently selected. It is updated at the end of each inspection, *time permitting*.

Note in the display example above that *no results data* appear alongside gage #3 and window #4. The reason is that these tools are *disabled*.

The *number* of gages and windows that appear in the Stat 1 Page depends on the selections that you make in the Disp. Windows, Disp. Gages, and Disp. Probe menu boxes in the Runtime Init. popup menu.

The following tables show the *maximum* number of gages and/or windows that can be displayed in all combinations with the Disp. Probe display *disabled* and *enabled*.

Light Probe Display *disabled*:

Gages	0	0	0	1	2	3	4	5	6	7	8	9	10	11	12
Windows	12	11	10	9	8	7	6	5	4	3	2	1	0	0	0

Light Probe Display *enabled*:

Gages	0	0	0	1	2	3	4	5	6	7	8	9
Windows	9	8	7	6	5	4	3	2	1	0	0	0

Interpreting Run Mode Displays (continued)

Stat 1 Page (continued)

If you pick the Disp. Windows (or Disp. Gages) menu box, then pick the Help symbol, the help message box will show the *current maximum* number of windows (or gages) whose results data can be displayed in the Stat 1 Page.

The PROBE, GAGE and WINDOW sections all show the number of inspections performed, the mean "reading" or measurement, the standard deviation, the minimum reading, and the maximum reading for the enabled probe and for each enabled gage and window.

Note that you can scroll this page using the Page ↓ and Page ↑ menu boxes, as with the Results page, above. Note also that you can *reset* the statistics to zero by picking the Reset Stat's menu box.

Stat 2 Page

If you picked the Stat 2 Page display selection, the Stat 2 Page will appear on the screen when you start the run mode, as follows:

REFERENCE WINDOW STATISTICS					
	Samples	Mean	Std. Dev.	Min. Reading	Max. Reading
1.1	1234	0.406	2.031	12	36
1.2	1234	0.675	3.467	19	57
1.3	1234	0.105	0.542	3	10
2.1	1234	.746	1.334	6	20
2.2					
2.3					
3.1					
3.2					
3.3					

The Stat 2 Page is a table that summarizes inspection results for all enabled reference *windows* in whichever tool set is currently selected. *The Stat 2 Page is updated at the end of each inspection, time permitting.*

This table shows the number of inspections performed, the mean "reading" or measurement, the standard deviation, the minimum reading, and the maximum reading for each of the three features in each enabled reference window. Blank lines indicate a disabled reference window or an inactive feature.

Note that you can *reset* the statistics to zero by picking the Reset Stat's menu box.

Displaying Other Tool Set

If you are using both tool sets, you can alternately display the two tool sets by picking the Display TS menu box successively.

When you pick the menu box, the current tool set number appears in the box. Thus, Display TS 1 becomes Display TS 2, and vice versa. Note that the *image* will also change if the other tool set uses the second camera.

Using Run Mode Halt and Freeze Functions

To use the halt and/or freeze functions, you can enable and "arm" these functions in the Runtime Init popup menu, as explained earlier.

You can also arm the enabled freeze or halt function by picking the Arm menu box in the Runmode menu and pick the appropriate arm selection, as follows:

Setup	Resume	Display T.S. 1	Reset Stat's	Page ↑	Page ↓
Arm ←	<input checked="" type="checkbox"/> Go on Reject	<input type="checkbox"/> Freeze 1st Rej	<input type="checkbox"/> Freeze All Rej's	<input type="checkbox"/> Freeze Next Insp	<input type="checkbox"/> Halt on Reject
Display ●●●					

Note that the five arm selections appear in boxes alongside the Arm menu box. The Go on Reject selection is darkened, indicating that the Go on Reject function is currently enabled. This means that the system will perform inspections and update the screen image *regardless* of the occurrence of a reject condition.

If the halt or freeze function is *disabled* (in the Runtime Init menu), you will not be able to pick the corresponding arm box. This is indicated by the **black** lettering in the box(es).

To arm the halt function *or* one of the freeze functions, pick the appropriate arm box.

Once you have armed the halt and/or freeze function, the system will respond when the given condition occurs. For example, if you have enabled the freeze function and then pick the Freeze 1st Rej box, the system will freeze the screen image and tool status when a reject condition from any tool occurs.

The system will *continue* inspections when the freeze function is enabled and armed, and will *halt* inspections when the halt function is enabled and armed.

If you want to resume normal inspection operations after a freeze or halt occurs, pick the Resume box. The system will continue normal inspection operations until the *next* freeze or halt condition occurs.

If you want to *disarm* halt or freeze conditions (without disabling these functions in the Runtime Init menu), pick the Go on Reject box.

Using Run Mode Halt and Freeze Functions (continued)

NOTE: If you return to the setup mode with a “frozen” or “halted” image on the monitor screen, and the camera resolution is set to 512H x 512V, any “learn” operation you perform on the frozen or halted image may produce a different result than is indicated on the Results Page. See Chapter 5, *Camera and Lighting Parameters*, for more information.

Appendix **A** Planning Discrete I/O Assignments and Connections

Appendix Objective

The objective of this appendix is to help you plan:

- The *number* of discrete output lines (up to 14) that your application will require.
 - The *function* that each output line will perform in your application.
 - The *assignment* of analysis tool “results” to output lines.
 - The *assignment* of status signals to output lines.
 - The *electrical and mechanical connections* of the trigger (input) and output lines to your production equipment.
-

Planning Output Line Assignments

This section provides a planning sheet that you can use to lay out the *function* and *tool* assignments for output lines.

The term “function assignment” refers to the type of signal information that you want an output line to carry to your production equipment.

The term “tool assignment” refers to the tool(s) that you assign to an output line. Note that tools can be assigned *only* to output lines that you have assigned a “results” *function*. These output lines will carry the “pass/fail” *results* signals from the tools during each inspection.

The next section, *Planning Output Line Connections*, provides electrical and timing diagrams and data. You will use these to identify and connect the output lines to your production equipment.

Using Output Line Planning Sheet

The Output Line Planning Sheet is a form on which you can lay out your plans for each output line. On this form you can account for:

- The 14 output lines.
- The six output line functions.
- The two tool sets (1 and 2).
- The 64 gages and their warning and fault outputs.
- The 48 windows and their warning and fault outputs.
- The 12 reference tools and their “pass/fail” outputs.
- The two light probes and their warning and fault outputs.

**Using Output Line
Planning Sheet (continued)**

Here is an example of how an Output Line Planning Sheet could be filled out:

**EXAMPLE OUTPUT LINE PLANNING SHEET:
Output Line Functions and Tool Assignments**

Line No.	Output Line Function	Tool Set No.	Gage				Window				Reference Tool		Light Probe	
			No.	Rng.	No.	Rng.	No.	Rng.	No.	Rng.	Line	Win.	Cam.	Rng.
1	Results	1	1	W	2	W	1	W	2	W				
"	"	"	3	W	4	W								
2	Results	1	1	F	2	F	1	F	2	F				
"	"	"	3	F	4	F								
3	Results	1									1	1		
4	Results	1											A	W
5	Results	1											A	F
6	Results	2	1	W	1	F								
"	"	"	2	W	2	F								
7	Strobe	1												
8	Trigger Nak	1												
9	Master Range	1												
10	Data Valid	1												
11	Module Busy	NA												
12	Not Used													
13	Not Used													
14	Not Used													

In the example planning sheet, the entries under "Output Line Function" have the following meanings:

- **Output Line 1:** The Results function is assigned to line 1. The Warning Range results (W) for gages 1-4 and windows 1 and 2 of tool set #1 are assigned to output line 1.
- **Output Line 2:** The Results function is assigned to line 2. The Fault Range results (F) for gages 1-4 and windows 1 and 2 of tool set #1 are assigned to output line 2.
- **Output Line 3:** The Results function is assigned to line 3. The "pass/fail" results for reference line 1 and reference window 1 of tool set #1 are assigned to line 3.

**Using Output Line
Planning Sheet (continued)**

- **Output Line 4:** The Results function is assigned to line 4. The Warning Range result from the camera A light probe is assigned to line 4. Camera A is assigned to tool set #1.
- **Output Line 5:** The Results function is assigned to line 5. The Fault Range result from the camera A light probe is assigned to line 5.
- **Output Line 6:** The Results function is assigned to line 6. The Warning and Fault Range results for gages 1 and 2 of tool set #2 are assigned to line 6.
- **Output Line 7:** The Strobe function for tool set #1 is assigned to line 7.
- **Output Line 8:** The Trigger NAK function for tool set #1 is assigned to line 8.
- **Output Line 9:** The Master Range function for tool set #1 is assigned to line 9.
- **Output Line 10:** The Data Valid function for tool set #1 is assigned to line 10.
- **Output Line 11:** The Module Busy function is assigned to line 11. (Note that this function does *not* relate to a tool set.)
- **Output Lines 12-14:** These lines are not used.

Note that output lines 1-6 are assigned the Results function. These lines will carry “pass/fail” results from the analysis tools to your production equipment. Lines 7-11 are assigned other functions. Lines 12-14 are not used.

Here is a brief explanation of the signal functions that you can assign to the output lines:

- **Module Busy:** This signal goes *high* when the CVIM system enters the configuration mode and during a configuration download operation. Module Busy goes *low* when the system enters the runmode (whether or not triggers are present).

You can assign the Module Busy function to only *one* output line.

NOTE: All of the remaining signal functions produce a *pulse* whose duration depends on the number of milliseconds that you assign to the Duration/1 (or Duration/2) parameter. (The “1” and “2” designate tool set #1 and tool set #2.)

- **1/Results:** This signal occurs when the “results” data of a tool inspection exceed the warning or fault limits. (The tool must be assigned to an output line that has already been assigned the 1/Results function.)

You can assign the 1/Results signal function to *any unassigned* output line.

As noted above, the 1/Results signal function must be assigned to an output line *before* any tool can be assigned to that line. Thus, if you wanted inspection results from

Using Output Line Planning Sheet (continued)

Ref. Line # 2 to be assigned to output line #10, you would *first* have to assign the 1/Results signal function to output line #10.

Note also that you can assign the inspection results from *any* tool in tool set #1 to an output line to which you have already assigned the 1/Results signal function.

- *1/Data Valid*: This signal occurs when the CVIM system has *completed* an inspection using tool set #1. The *inspection results signals* (the “data”) are *stable* on all output lines assigned to the 1/Results signal function.

Note that 1/Data Valid does *not* indicate whether an inspection has passed or failed. That is the task of the output lines assigned to the 1/Results signal function.

You can assign the 1/Data Valid function to only *one* output line.

- *1/Trigger Nak*: This signal occurs when the CVIM system receives a trigger input signal for tool set #1, but cannot process that trigger.

You can assign the 1/Trigger Nak function to only *one* output line.

- *1/Master Range*: This signal occurs when *any* tool in tool set #1 fails its inspection task. For a light probe or inspection tool, this means a “results” value that exceeds a *fault* range limit. For a reference tool, it means failing to find an edge or feature.

You can assign the 1/Master Range Alarm function to only *one* output line.

- *1/Strobe*: This signal occurs within 1ms after the CVIM system receives a trigger input signal.

You can assign the 1/Strobe function to only *one* output line.

- *1/Duration (n)ms*: This determines the pulse duration, in milliseconds, of *all* pulse-type signals.

- *2/Trigger NAK, 2/Master Range, 2/Data Valid, 2/Strobe, 2/Results, and 2/Duration (n)ms*: These functions apply to the tools in tool set #2.

In *your* application, the function and tool assignment(s) for each output line will of course depend on the specific requirements of your production equipment.

You will find a full-page, blank copy of the planning sheet on the last page of this appendix. We suggest that you do not mark that page, but use it instead as a copy master, and use the copies to prepare your output line plans.

Keep in mind that a *completed* planning sheet can serve also as a *record* of your output line usage. You may find it desirable to store your filled-out planning sheets in a file folder or loose leaf binder.

Using Output Signal Timing Data

To make proper use of the signal data available to the output lines, you must first understand the timing relationships that exist between the trigger *input* signal (which starts each inspection cycle) and the *output* signals.

Knowing these signal timing relationships enables you to accurately *synchronize* the inspection cycles with your production equipment.

Timing charts A, B, and C, show the timing relationships in various circumstances.

Chart A shows the relationship between the trigger leading edge and the Strobe, Data Valid, Results, and Master Range signals, where the last three appear as *pulses* whose

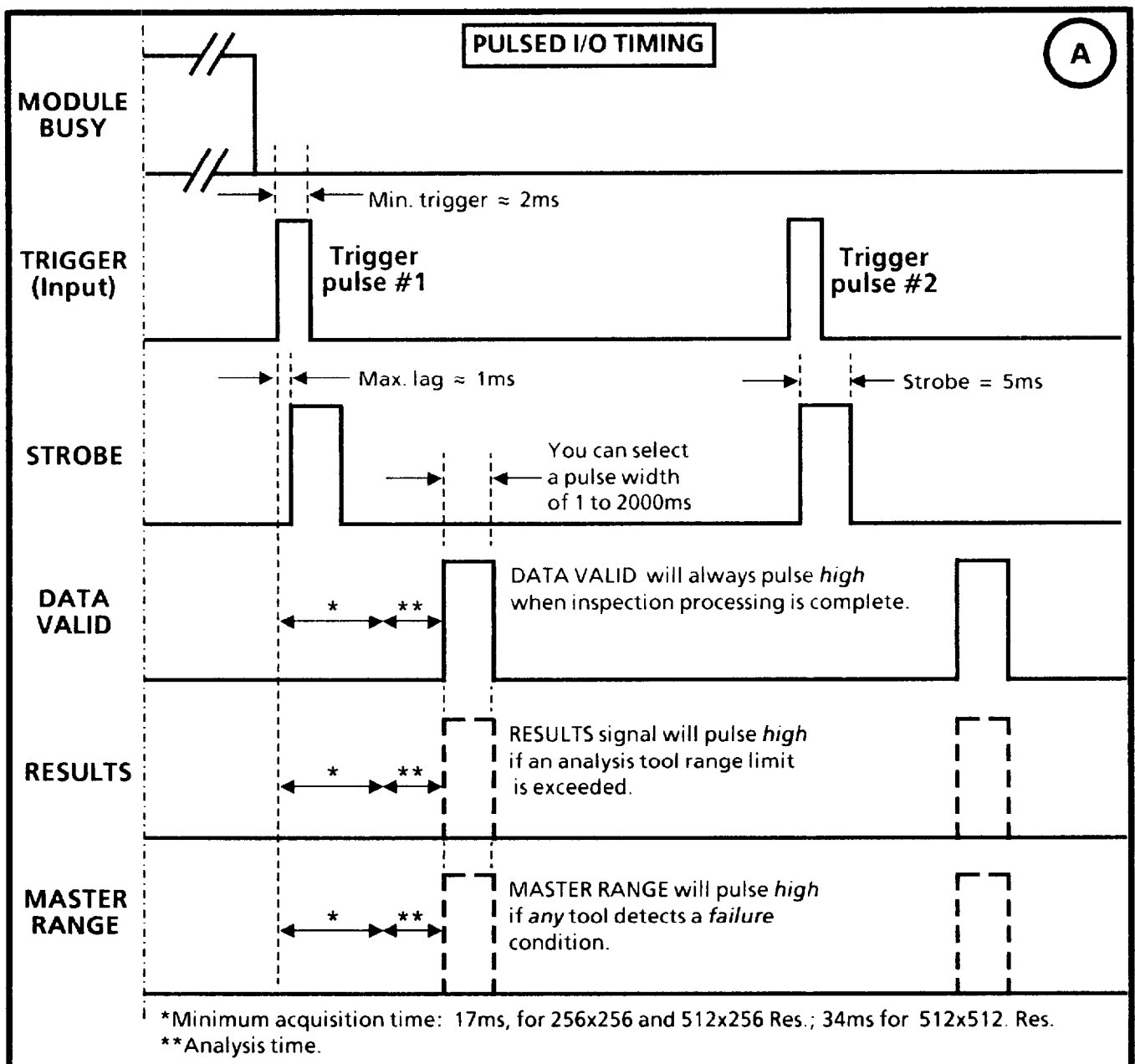

Using Output Signal Timing Data (continued)

duration you determine during configuration. Whenever these signals go *high*, they will go *low* again at the *end* of the specified pulse duration (1 to 2000ms).

Note also that Module Busy is *high* only during system configuration and when the CVIM module is receiving a configuration *download* from PLC or computer equipment.

In Chart B, the Data Valid, Results, and Master Range signals appear as *changes in signal levels*. This will occur if, during system configuration, you select a pulse "duration" of 0 (zero) milliseconds. In this case, the three signals will *stay high* until the leading edge of the next valid trigger signal (trigger pulse #2).

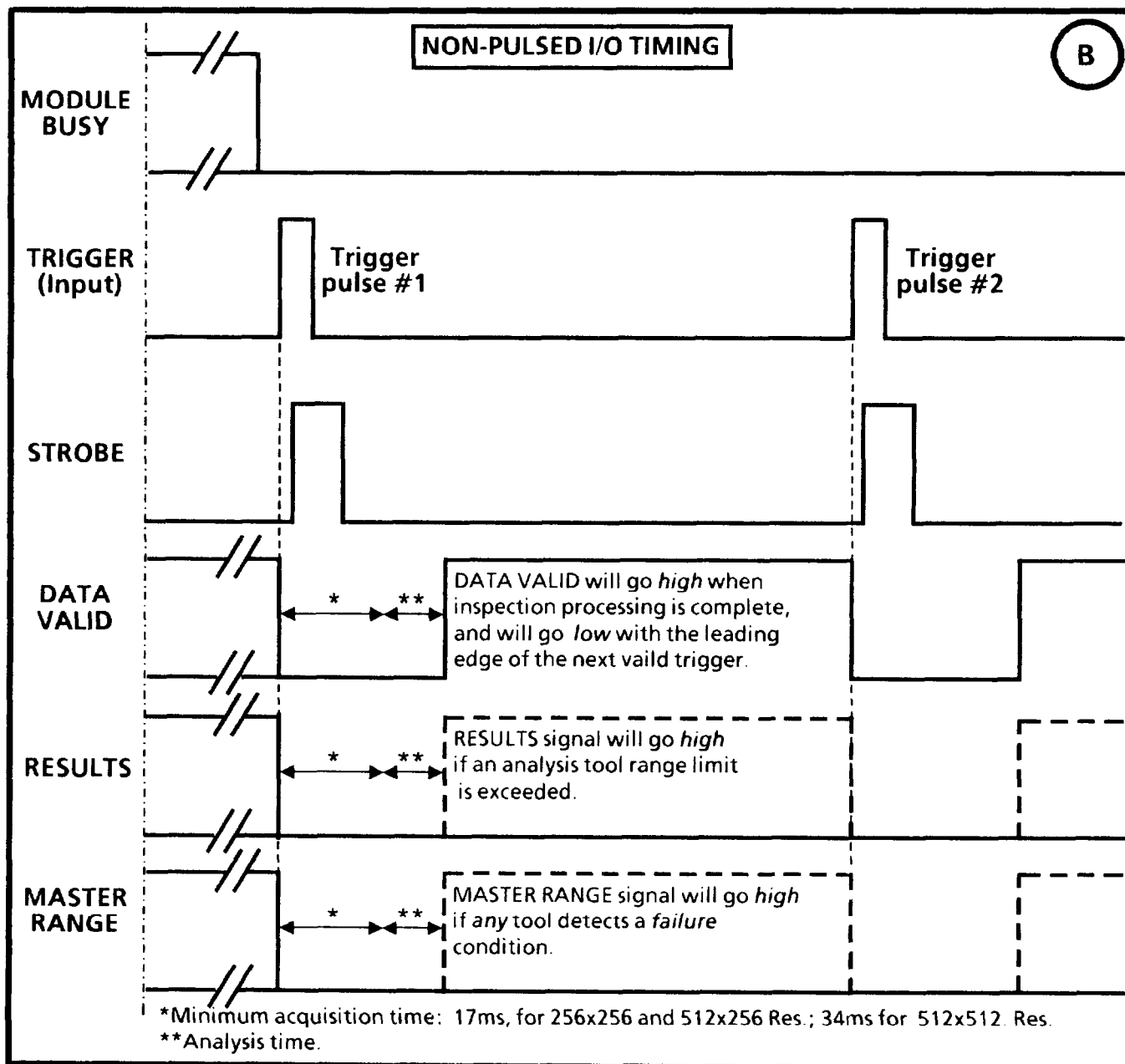

Using Output Signal Timing Data (continued)

The CVIM system will “miss” a trigger pulse in the following circumstances:

- The trigger pulse occurs within 5ms after the previous trigger pulse. (No Trigger NAK signal.)
- The trigger pulse occurs within the *same* camera image field. (The Trigger NAK signal follows.)
- The trigger pulse occurs within the *next* camera image field and the image resolution is 512H x512V. (The Trigger NAK signal follows.)
- The trigger pulse occurs *before* the previous inspection is complete and sufficient memory is available to acquire the image. (The Trigger NAK signal follows.)

Chart C shows trigger pulse #2 occurring *before* the CVIM system has finished processing the inspection cycle started by trigger pulse #1. This causes the Trigger NAK signal to go *high*. Trigger NAK will *stay* high until leading edge of the next *valid* trigger pulse (trigger pulse #3).

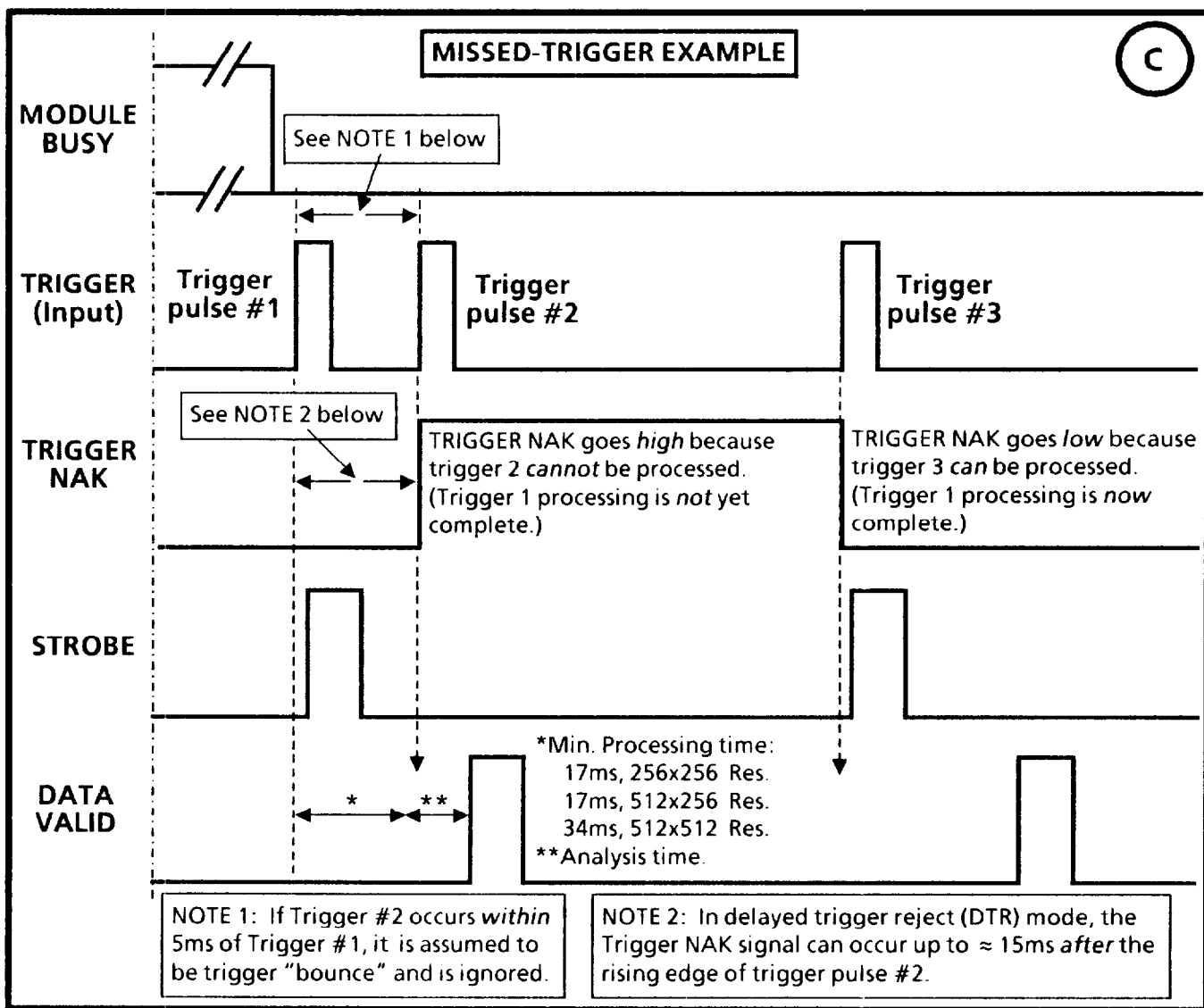

Planning Output Line Connections

This section provides diagrams of electrical connections for correctly connecting your production equipment to the CVIM system's discrete output lines.

The 26-pin D-type connector on the CVIM module's front panel is designed for direct connection to the I/O Interface Box, Catalog No. 2801-N21, through the CVIM-to-I/O Interface Box cable, Catalog No. 2801-NC17.

If you intend to use an I/O connection of your own design, you will need to know the pin assignments and the signal names and functions for each pin.

The following diagram shows the pin numbers and layout on the 26-pin D-type connector as it appears when you look at the front panel of the CVIM module.

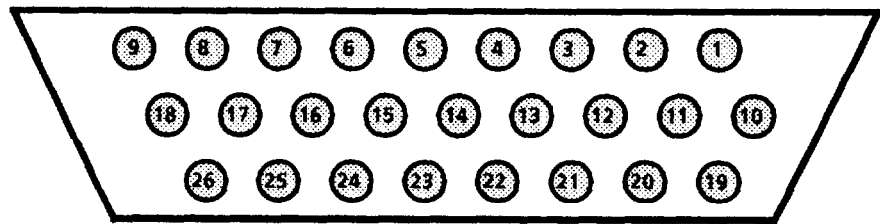

The following table shows the signal name/function for each pin on the 26-pin D-type connector:

Pin 1: Trigger input line #1.	Pin 14: Output line #12.
Pin 2: Trigger input line #2.	Pin 15: Output line #13.
Pin 3: Output line #1.	Pin 16: Output line #14.
Pin 4: Output line #2.	Pin 17: Reserved.
Pin 5: Output line #3.	Pin 18: Reserved.
Pin 6: Output line #4.	Pin 19: Ground (power).
Pin 7: Output line #5.	Pin 20: Ground (power).
Pin 8: Output line #6.	Pin 21: Ground (chassis).
Pin 9: Output line #7.	Pin 22: Ground (signal).
Pin 10: Output line #8.	Pin 23: TXD (Transmit Data - RS-232).
Pin 11: Output line #9.	Pin 24: RTS (Request to Send - RS-232).
Pin 12: Output line #10.	Pin 25: RXD (Receive Data - RS-232).
Pin 13: Output line #11.	Pin 26: CTS (Clear to Send - RS-232).

Planning Connections to RS-232 Connector

The RS-232 connector is a 9-pin D-type connector on the I/O Interface Box and is designed for connection to your computer equipment. (For more information about connecting the CVIM system to peripheral serial devices, refer to the *CVIM Communications Manual*, Catalog No. 5370-ND002.)

If you intend to use the RS-232 connection on the I/O Interface Box, you will need to know the pin assignments and the signal names and functions for each pin.

The following diagram shows the pin numbers and layout on the RS-232 connector as it appears when you look at the front of the I/O Interface Box.

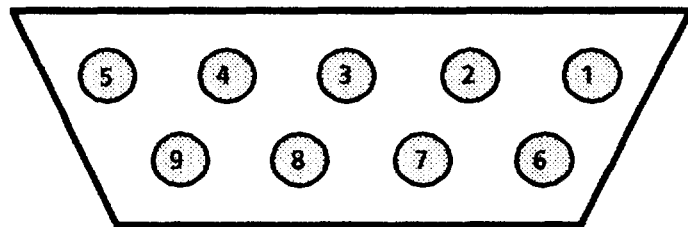

The following table shows the signal name/function for each pin on the RS-232 connector:

Pin 1: No connection.	Pin 6: No connection.
Pin 2: RXD (Receive Data - RS-232).	Pin 7: RTS (Request to Send - RS-232).
Pin 3: TXD (Transmit Data - RS-232).	Pin 8: CTS (Clear to Send - RS-232).
Pin 4: Ground (chassis).	Pin 9: No connection.
Pin 5: Ground (signal).	

Planning I/O Connections to 1771-JMB Interface Board

The 1771-JMB interface board is designed for direct edge connection to the I/O Interface Box, Catalog No. 2801-N21.

If you intend to use the JMB board and the I/O Interface Box, you will need to know the relationship between the discrete I/O line numbers and the LED numbers, the optic isolator type, and the terminal block screws numbers on the JMB board. These are shown in the figure and table that follows.

Note that the JMB board has a terminal block for connection of an external +5VDC power supply. This provides power to the JMB board.

**Planning Connections to
1771-JMB Interface Board**
(continued)

The figure shows the layout of the JMB board and the adhesive-backed overlay with the I/O line numbers.

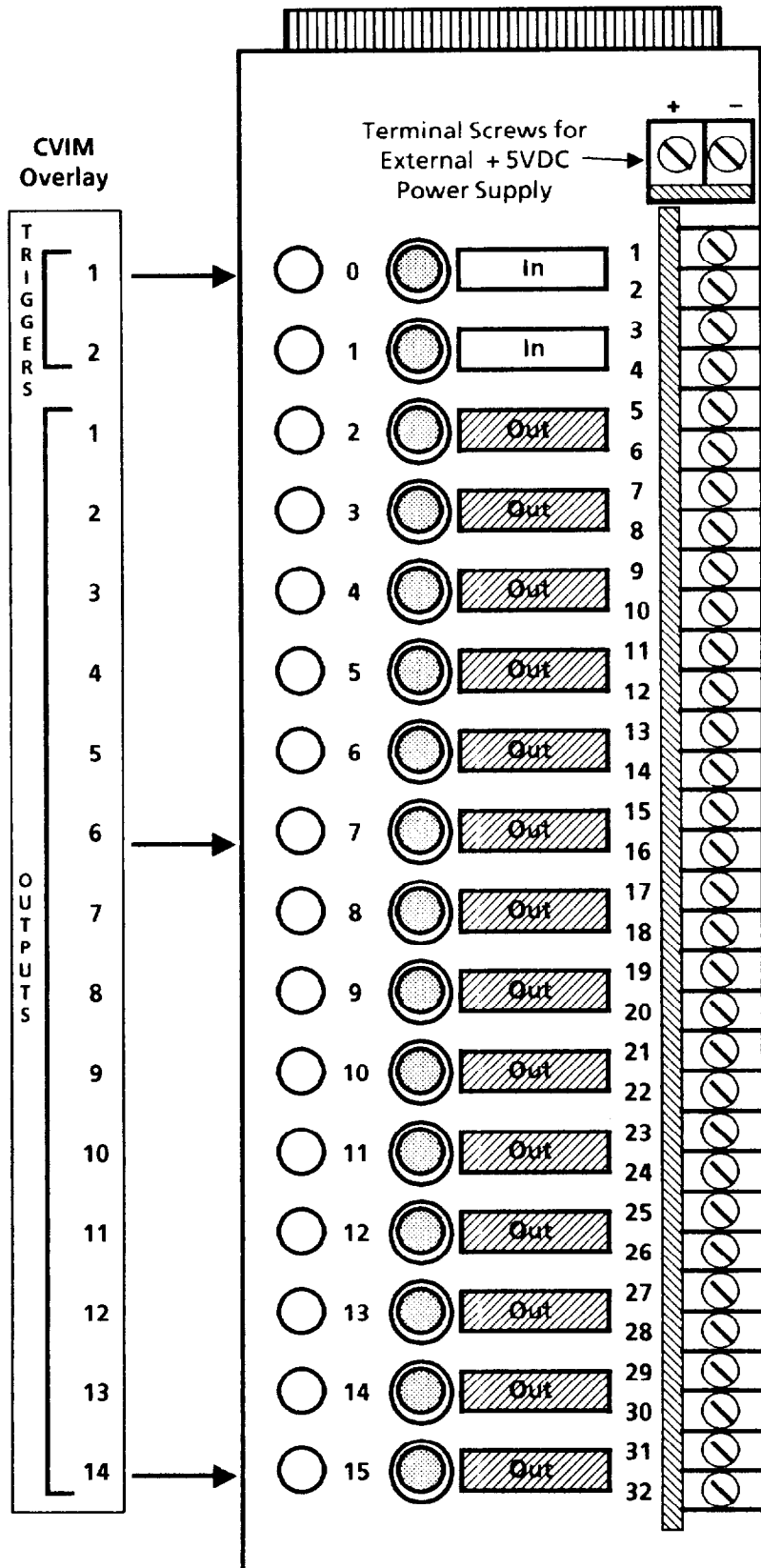

**Planning Connections to
1771-JMB Interface Board**
(continued)

The following table shows the relationship between the numbers mentioned above:

Discrete I/O Line Number		LED and I/O Module Number	Terminal Screw and Polarity	
Input	Output		+	-
1		0	1	2
2		1	3	4
	1	2	5	6
	2	3	7	8
	3	4	9	10
	4	5	11	12
	5	6	13	14
	6	7	15	16
	7	8	17	18
	8	9	19	20
	9	10	21	22
	10	11	23	24
	11	12	25	26
	12	13	27	28
	13	14	29	30
	14	15	31	32

Be sure to observe the following warning when connecting the I/O lines to your production equipment.



WARNING: The CVIM local I/O lines will be *disabled* whenever hardware or software faults occur in the CVIM module and/or other modules in the Pyramid Integrator chassis. Failure to accommodate this logic convention when you interface the CVIM I/O lines to your production equipment may cause unintended operation of your equipment, which may result in serious personal injury or death.

Appendix **B** Planning System Configuration

Appendix Objective

The objective of this appendix is to help you plan your CVIM system configuration by preparing a series of tables that you can use during the system configuration process.

System Configuration Planning

This appendix provides a series of tables that can help you select the parameters and functions within each configuration category in the Main Configuration menu:

Env.	Camera A	Ref. Line	Ref. Win	Gage	Window	Misc	
------	----------	-----------	----------	------	--------	------	--

Note that Chapters 4 through 9 of this manual describe these seven configuration categories in detail.

The tables are arranged in the same order as the chapters. Each table pertains to a specific set of configuration parameters and/or functions within a main configuration category. You can record the parameters and/or functions that are appropriate for your application of the CVIM system.

The information that you've recorded in these tables can help you perform the configuration procedures described in Chapters 4 through 9 of this manual. When you finish the configuration procedures, the tables can then serve as a *record* of your configuration or configurations.

Before you begin, we suggest that you remove the pages containing the configuration planning tables and make one or more working copies of them.

Configuration Planning Tables

On the next several pages are the configuration planning tables. Do not mark these pages. Instead, remove them and make as many copies as you need for you configuration planning.

System Parameters			
Host Select:	Tool Display:	Monitor:	Units:
Stand Alone <input type="checkbox"/>	On <input type="checkbox"/>	Color <input type="checkbox"/>	Pixels <input type="checkbox"/>
Pyramid <input type="checkbox"/>	Off <input type="checkbox"/>	Monochrome <input type="checkbox"/>	Inches <input type="checkbox"/>
Remote I/O <input type="checkbox"/>			CM <input type="checkbox"/>
RS-232 <input type="checkbox"/>			

Configuration Planning Tables (continued)

I/O Parameters (1 of 2)														
Output Line Functions:	Output Line Numbers:													
	1	2	3	4	5	6	7	8	9	10	11	12	13	14
1/Results	<input type="checkbox"/>	<input type="checkbox"/>	<input type="checkbox"/>	<input type="checkbox"/>	<input type="checkbox"/>	<input type="checkbox"/>	<input type="checkbox"/>	<input type="checkbox"/>	<input type="checkbox"/>	<input type="checkbox"/>	<input type="checkbox"/>	<input type="checkbox"/>	<input type="checkbox"/>	<input type="checkbox"/>
1/Data Valid	<input type="checkbox"/>	<input type="checkbox"/>	<input type="checkbox"/>	<input type="checkbox"/>	<input type="checkbox"/>	<input type="checkbox"/>	<input type="checkbox"/>	<input type="checkbox"/>	<input type="checkbox"/>	<input type="checkbox"/>	<input type="checkbox"/>	<input type="checkbox"/>	<input type="checkbox"/>	<input type="checkbox"/>
1/Strobe	<input type="checkbox"/>	<input type="checkbox"/>	<input type="checkbox"/>	<input type="checkbox"/>	<input type="checkbox"/>	<input type="checkbox"/>	<input type="checkbox"/>	<input type="checkbox"/>	<input type="checkbox"/>	<input type="checkbox"/>	<input type="checkbox"/>	<input type="checkbox"/>	<input type="checkbox"/>	<input type="checkbox"/>
1/Trigger Nak	<input type="checkbox"/>	<input type="checkbox"/>	<input type="checkbox"/>	<input type="checkbox"/>	<input type="checkbox"/>	<input type="checkbox"/>	<input type="checkbox"/>	<input type="checkbox"/>	<input type="checkbox"/>	<input type="checkbox"/>	<input type="checkbox"/>	<input type="checkbox"/>	<input type="checkbox"/>	<input type="checkbox"/>
1/Master Range	<input type="checkbox"/>	<input type="checkbox"/>	<input type="checkbox"/>	<input type="checkbox"/>	<input type="checkbox"/>	<input type="checkbox"/>	<input type="checkbox"/>	<input type="checkbox"/>	<input type="checkbox"/>	<input type="checkbox"/>	<input type="checkbox"/>	<input type="checkbox"/>	<input type="checkbox"/>	<input type="checkbox"/>
2/Results	<input type="checkbox"/>	<input type="checkbox"/>	<input type="checkbox"/>	<input type="checkbox"/>	<input type="checkbox"/>	<input type="checkbox"/>	<input type="checkbox"/>	<input type="checkbox"/>	<input type="checkbox"/>	<input type="checkbox"/>	<input type="checkbox"/>	<input type="checkbox"/>	<input type="checkbox"/>	<input type="checkbox"/>
2/Data Valid	<input type="checkbox"/>	<input type="checkbox"/>	<input type="checkbox"/>	<input type="checkbox"/>	<input type="checkbox"/>	<input type="checkbox"/>	<input type="checkbox"/>	<input type="checkbox"/>	<input type="checkbox"/>	<input type="checkbox"/>	<input type="checkbox"/>	<input type="checkbox"/>	<input type="checkbox"/>	<input type="checkbox"/>
2/Strobe	<input type="checkbox"/>	<input type="checkbox"/>	<input type="checkbox"/>	<input type="checkbox"/>	<input type="checkbox"/>	<input type="checkbox"/>	<input type="checkbox"/>	<input type="checkbox"/>	<input type="checkbox"/>	<input type="checkbox"/>	<input type="checkbox"/>	<input type="checkbox"/>	<input type="checkbox"/>	<input type="checkbox"/>
2/Trigger Nak	<input type="checkbox"/>	<input type="checkbox"/>	<input type="checkbox"/>	<input type="checkbox"/>	<input type="checkbox"/>	<input type="checkbox"/>	<input type="checkbox"/>	<input type="checkbox"/>	<input type="checkbox"/>	<input type="checkbox"/>	<input type="checkbox"/>	<input type="checkbox"/>	<input type="checkbox"/>	<input type="checkbox"/>
2/Master Range	<input type="checkbox"/>	<input type="checkbox"/>	<input type="checkbox"/>	<input type="checkbox"/>	<input type="checkbox"/>	<input type="checkbox"/>	<input type="checkbox"/>	<input type="checkbox"/>	<input type="checkbox"/>	<input type="checkbox"/>	<input type="checkbox"/>	<input type="checkbox"/>	<input type="checkbox"/>	<input type="checkbox"/>
Module Busy	<input type="checkbox"/>	<input type="checkbox"/>	<input type="checkbox"/>	<input type="checkbox"/>	<input type="checkbox"/>	<input type="checkbox"/>	<input type="checkbox"/>	<input type="checkbox"/>	<input type="checkbox"/>	<input type="checkbox"/>	<input type="checkbox"/>	<input type="checkbox"/>	<input type="checkbox"/>	<input type="checkbox"/>
Not Used	<input type="checkbox"/>	<input type="checkbox"/>	<input type="checkbox"/>	<input type="checkbox"/>	<input type="checkbox"/>	<input type="checkbox"/>	<input type="checkbox"/>	<input type="checkbox"/>	<input type="checkbox"/>	<input type="checkbox"/>	<input type="checkbox"/>	<input type="checkbox"/>	<input type="checkbox"/>	<input type="checkbox"/>

Pulse Duration	Time in Milliseconds
1/Duration	_____ms
2/Duration	_____ms

I/O Parameters (2 of 2)						
RS-232 Parameters				Remote I/O Parameters		
Baud Rate:				Remote:	Rack Address:	
300	<input type="checkbox"/>	4800	<input type="checkbox"/>	Disabled	<input type="checkbox"/>	0 <input type="checkbox"/> 1 <input type="checkbox"/>
1200	<input type="checkbox"/>	9600	<input type="checkbox"/>	Enabled	<input type="checkbox"/>	2 <input type="checkbox"/> 3 <input type="checkbox"/>
2400	<input type="checkbox"/>	19200	<input type="checkbox"/>	Data Rate:		4 <input type="checkbox"/> 5 <input type="checkbox"/>
Protocol:				57.6	<input type="checkbox"/>	6 <input type="checkbox"/> 7 <input type="checkbox"/>
ASCII <input type="checkbox"/>				115.2	<input type="checkbox"/>	
DF1 <input type="checkbox"/>				230.4	<input type="checkbox"/>	

**Configuration Planning
Tables (continued)**

Tool Set Parameters			
Camera/Tool Set Combination:		Trigger Source	
		Tool Set #1, Runtime:	Tool Set #2, Runtime:
Camera A, Tool Set #1	<input type="checkbox"/>	None/Disabled	<input type="checkbox"/>
Camera A, Tool Set #2	<input type="checkbox"/>	Auto/Internal	<input type="checkbox"/>
Camera A, Tool Sets #1 and #2	<input type="checkbox"/>	I/O	<input type="checkbox"/>
Camera B, Tool Set #1	<input type="checkbox"/>	Host	<input type="checkbox"/>
Camera B, Tool Set #2	<input type="checkbox"/>	Host (Tool Set #2)	<input type="checkbox"/>
Camera B, Tool Set #1	<input type="checkbox"/>	Host (Tool Set #1)	<input type="checkbox"/>
		Tool Set #1, Setup:	Tool Set #2, Setup:
Camera B, Tool Sets #1 and #2	<input type="checkbox"/>	Auto/Internal	<input type="checkbox"/>
Camera A, Tool Set #1	<input type="checkbox"/>	Same as Runtime	Same as Runtime
Camera B, Tool Set #2	<input type="checkbox"/>		
Camera A, Tool Set #2	<input type="checkbox"/>		
Camera B, Tool Set #1	<input type="checkbox"/>		

Camera Parameters				
Camera:	Light Probe:	Image Resolution:	Calibration:	Camera Type:
A	Disabled	<input type="checkbox"/>	256Hx256V	<input type="checkbox"/>
	Same Field	<input type="checkbox"/>	512Hx256V	<input type="checkbox"/>
	Next Field	<input type="checkbox"/>	512Hx512V	<input type="checkbox"/>
B	Disabled	<input type="checkbox"/>	256Hx256V	<input type="checkbox"/>
	Same Field	<input type="checkbox"/>	512Hx256V	<input type="checkbox"/>
	Next Field	<input type="checkbox"/>	512Hx512V	<input type="checkbox"/>
			Object Calib.	<input type="checkbox"/>
			Grid Calib.	<input type="checkbox"/>
			Standard Camera	<input type="checkbox"/>
			Std. Cam., DTR Mode	<input type="checkbox"/>
			*Frame Reset Camera	<input type="checkbox"/>

*NOTE: If your application requires two cameras and you select Frame Reset Camera, both cameras must be the frame reset type.

**Configuration Planning
Tables (continued)**

Reference Line Parameters (Part 3 of 3)				
Source: Reference Line #	Destination: Reference Line #:			
	None	1	2	3
Reference Line #1	<input type="checkbox"/>	NA	<input type="checkbox"/>	<input type="checkbox"/>
Reference Line #2	<input type="checkbox"/>	NA	NA	<input type="checkbox"/>

Reference Window Parameters							
Reference Window Status:	Reference Window #:			Reference Tool Assignment			
	1	2	3	Source: Reference Tool #	Destination: Reference Window #		
					1	2	3
Enable	<input type="checkbox"/>	<input type="checkbox"/>	<input type="checkbox"/>	None	<input type="checkbox"/>	<input type="checkbox"/>	<input type="checkbox"/>
Disable	<input type="checkbox"/>	<input type="checkbox"/>	<input type="checkbox"/>	Ref. Line #1	<input type="checkbox"/>	<input type="checkbox"/>	<input type="checkbox"/>
Reference Window Function:	1	2	3	Ref. Line #2	<input type="checkbox"/>	<input type="checkbox"/>	<input type="checkbox"/>
X-Y Shift Compensation <i>only</i> : Use <i>One</i> Active Feature	<input type="checkbox"/>	<input type="checkbox"/>	<input type="checkbox"/>	Ref. Line #3	<input type="checkbox"/>	<input type="checkbox"/>	<input type="checkbox"/>
X-Y Shift <i>and</i> Rotation Compensation: Use <i>Two</i> Active Features	<input type="checkbox"/>	<input type="checkbox"/>	<input type="checkbox"/>	Ref. Win. #1	NA	<input type="checkbox"/>	<input type="checkbox"/>
X-Y Shift <i>and</i> Rotation Compensation: Use <i>Three</i> Active Features	<input type="checkbox"/>	<input type="checkbox"/>	<input type="checkbox"/>	Ref. Win. #2	NA	NA	<input type="checkbox"/>
Output Line Assignment:	1	2	3				
Output Line # (Fill in):	___	___	___				

Configuration Planning
Tables (continued)

Gage Parameters: Tool Set # ___ (Part 1 of 6)																
Gage Status:	Gage Number (1 - 16):															
	1	2	3	4	5	6	7	8	9	10	11	12	13	14	15	16
Enable	<input type="checkbox"/>	<input type="checkbox"/>	<input type="checkbox"/>	<input type="checkbox"/>	<input type="checkbox"/>	<input type="checkbox"/>	<input type="checkbox"/>	<input type="checkbox"/>	<input type="checkbox"/>	<input type="checkbox"/>	<input type="checkbox"/>	<input type="checkbox"/>	<input type="checkbox"/>	<input type="checkbox"/>	<input type="checkbox"/>	<input type="checkbox"/>
Disable	<input type="checkbox"/>	<input type="checkbox"/>	<input type="checkbox"/>	<input type="checkbox"/>	<input type="checkbox"/>	<input type="checkbox"/>	<input type="checkbox"/>	<input type="checkbox"/>	<input type="checkbox"/>	<input type="checkbox"/>	<input type="checkbox"/>	<input type="checkbox"/>	<input type="checkbox"/>	<input type="checkbox"/>	<input type="checkbox"/>	<input type="checkbox"/>
Gage Shape:	1	2	3	4	5	6	7	8	9	10	11	12	13	14	15	16
Linear	<input type="checkbox"/>	<input type="checkbox"/>	<input type="checkbox"/>	<input type="checkbox"/>	<input type="checkbox"/>	<input type="checkbox"/>	<input type="checkbox"/>	<input type="checkbox"/>	<input type="checkbox"/>	<input type="checkbox"/>	<input type="checkbox"/>	<input type="checkbox"/>	<input type="checkbox"/>	<input type="checkbox"/>	<input type="checkbox"/>	<input type="checkbox"/>
Circular	<input type="checkbox"/>	<input type="checkbox"/>	<input type="checkbox"/>	<input type="checkbox"/>	<input type="checkbox"/>	<input type="checkbox"/>	<input type="checkbox"/>	<input type="checkbox"/>	<input type="checkbox"/>	<input type="checkbox"/>	<input type="checkbox"/>	<input type="checkbox"/>	<input type="checkbox"/>	<input type="checkbox"/>	<input type="checkbox"/>	<input type="checkbox"/>
*Gaging Mode:	1	2	3	4	5	6	7	8	9	10	11	12	13	14	15	16
Binary Mode	<input type="checkbox"/>	<input type="checkbox"/>	<input type="checkbox"/>	<input type="checkbox"/>	<input type="checkbox"/>	<input type="checkbox"/>	<input type="checkbox"/>	<input type="checkbox"/>	<input type="checkbox"/>	<input type="checkbox"/>	<input type="checkbox"/>	<input type="checkbox"/>	<input type="checkbox"/>	<input type="checkbox"/>	<input type="checkbox"/>	<input type="checkbox"/>
Gray Scale Mode	<input type="checkbox"/>	<input type="checkbox"/>	<input type="checkbox"/>	<input type="checkbox"/>	<input type="checkbox"/>	<input type="checkbox"/>	<input type="checkbox"/>	<input type="checkbox"/>	<input type="checkbox"/>	<input type="checkbox"/>	<input type="checkbox"/>	<input type="checkbox"/>	<input type="checkbox"/>	<input type="checkbox"/>	<input type="checkbox"/>	<input type="checkbox"/>
Sub Pixel Resolution	<input type="checkbox"/>	<input type="checkbox"/>	<input type="checkbox"/>	<input type="checkbox"/>	<input type="checkbox"/>	<input type="checkbox"/>	<input type="checkbox"/>	<input type="checkbox"/>	<input type="checkbox"/>	<input type="checkbox"/>	<input type="checkbox"/>	<input type="checkbox"/>	<input type="checkbox"/>	<input type="checkbox"/>	<input type="checkbox"/>	<input type="checkbox"/>
Gage Width: 1 Pixel	<input type="checkbox"/>	<input type="checkbox"/>	<input type="checkbox"/>	<input type="checkbox"/>	<input type="checkbox"/>	<input type="checkbox"/>	<input type="checkbox"/>	<input type="checkbox"/>	<input type="checkbox"/>	<input type="checkbox"/>	<input type="checkbox"/>	<input type="checkbox"/>	<input type="checkbox"/>	<input type="checkbox"/>	<input type="checkbox"/>	<input type="checkbox"/>
Gage Width: 3 Pixels	<input type="checkbox"/>	<input type="checkbox"/>	<input type="checkbox"/>	<input type="checkbox"/>	<input type="checkbox"/>	<input type="checkbox"/>	<input type="checkbox"/>	<input type="checkbox"/>	<input type="checkbox"/>	<input type="checkbox"/>	<input type="checkbox"/>	<input type="checkbox"/>	<input type="checkbox"/>	<input type="checkbox"/>	<input type="checkbox"/>	<input type="checkbox"/>
Gage Width: 5 Pixels	<input type="checkbox"/>	<input type="checkbox"/>	<input type="checkbox"/>	<input type="checkbox"/>	<input type="checkbox"/>	<input type="checkbox"/>	<input type="checkbox"/>	<input type="checkbox"/>	<input type="checkbox"/>	<input type="checkbox"/>	<input type="checkbox"/>	<input type="checkbox"/>	<input type="checkbox"/>	<input type="checkbox"/>	<input type="checkbox"/>	<input type="checkbox"/>
Gaging Operation:	1	2	3	4	5	6	7	8	9	10	11	12	13	14	15	16
Count White Pixels	<input type="checkbox"/>	<input type="checkbox"/>	<input type="checkbox"/>	<input type="checkbox"/>	<input type="checkbox"/>	<input type="checkbox"/>	<input type="checkbox"/>	<input type="checkbox"/>	<input type="checkbox"/>	<input type="checkbox"/>	<input type="checkbox"/>	<input type="checkbox"/>	<input type="checkbox"/>	<input type="checkbox"/>	<input type="checkbox"/>	<input type="checkbox"/>
Count Black Pixels	<input type="checkbox"/>	<input type="checkbox"/>	<input type="checkbox"/>	<input type="checkbox"/>	<input type="checkbox"/>	<input type="checkbox"/>	<input type="checkbox"/>	<input type="checkbox"/>	<input type="checkbox"/>	<input type="checkbox"/>	<input type="checkbox"/>	<input type="checkbox"/>	<input type="checkbox"/>	<input type="checkbox"/>	<input type="checkbox"/>	<input type="checkbox"/>
Count White Objects	<input type="checkbox"/>	<input type="checkbox"/>	<input type="checkbox"/>	<input type="checkbox"/>	<input type="checkbox"/>	<input type="checkbox"/>	<input type="checkbox"/>	<input type="checkbox"/>	<input type="checkbox"/>	<input type="checkbox"/>	<input type="checkbox"/>	<input type="checkbox"/>	<input type="checkbox"/>	<input type="checkbox"/>	<input type="checkbox"/>	<input type="checkbox"/>
Count Black Objects	<input type="checkbox"/>	<input type="checkbox"/>	<input type="checkbox"/>	<input type="checkbox"/>	<input type="checkbox"/>	<input type="checkbox"/>	<input type="checkbox"/>	<input type="checkbox"/>	<input type="checkbox"/>	<input type="checkbox"/>	<input type="checkbox"/>	<input type="checkbox"/>	<input type="checkbox"/>	<input type="checkbox"/>	<input type="checkbox"/>	<input type="checkbox"/>
Count Edges	<input type="checkbox"/>	<input type="checkbox"/>	<input type="checkbox"/>	<input type="checkbox"/>	<input type="checkbox"/>	<input type="checkbox"/>	<input type="checkbox"/>	<input type="checkbox"/>	<input type="checkbox"/>	<input type="checkbox"/>	<input type="checkbox"/>	<input type="checkbox"/>	<input type="checkbox"/>	<input type="checkbox"/>	<input type="checkbox"/>	<input type="checkbox"/>
Measure Line Length	<input type="checkbox"/>	<input type="checkbox"/>	<input type="checkbox"/>	<input type="checkbox"/>	<input type="checkbox"/>	<input type="checkbox"/>	<input type="checkbox"/>	<input type="checkbox"/>	<input type="checkbox"/>	<input type="checkbox"/>	<input type="checkbox"/>	<input type="checkbox"/>	<input type="checkbox"/>	<input type="checkbox"/>	<input type="checkbox"/>	<input type="checkbox"/>
X Position	<input type="checkbox"/>	<input type="checkbox"/>	<input type="checkbox"/>	<input type="checkbox"/>	<input type="checkbox"/>	<input type="checkbox"/>	<input type="checkbox"/>	<input type="checkbox"/>	<input type="checkbox"/>	<input type="checkbox"/>	<input type="checkbox"/>	<input type="checkbox"/>	<input type="checkbox"/>	<input type="checkbox"/>	<input type="checkbox"/>	<input type="checkbox"/>
Y Position	<input type="checkbox"/>	<input type="checkbox"/>	<input type="checkbox"/>	<input type="checkbox"/>	<input type="checkbox"/>	<input type="checkbox"/>	<input type="checkbox"/>	<input type="checkbox"/>	<input type="checkbox"/>	<input type="checkbox"/>	<input type="checkbox"/>	<input type="checkbox"/>	<input type="checkbox"/>	<input type="checkbox"/>	<input type="checkbox"/>	<input type="checkbox"/>
Measure Chord Angle (circular gage only)	<input type="checkbox"/>	<input type="checkbox"/>	<input type="checkbox"/>	<input type="checkbox"/>	<input type="checkbox"/>	<input type="checkbox"/>	<input type="checkbox"/>	<input type="checkbox"/>	<input type="checkbox"/>	<input type="checkbox"/>	<input type="checkbox"/>	<input type="checkbox"/>	<input type="checkbox"/>	<input type="checkbox"/>	<input type="checkbox"/>	<input type="checkbox"/>
Measure Wedge Angle (circular gage only)	<input type="checkbox"/>	<input type="checkbox"/>	<input type="checkbox"/>	<input type="checkbox"/>	<input type="checkbox"/>	<input type="checkbox"/>	<input type="checkbox"/>	<input type="checkbox"/>	<input type="checkbox"/>	<input type="checkbox"/>	<input type="checkbox"/>	<input type="checkbox"/>	<input type="checkbox"/>	<input type="checkbox"/>	<input type="checkbox"/>	<input type="checkbox"/>

***Note:** Sub Pixel Resolution and Gage Width apply only to Gray Scale Mode.

**Configuration Planning
Tables (continued)**

Gage Parameters: Tool Set # <u> </u> (Part 3 of 6)																
Gage Status:	Gage Number (17 - 32):															
	17	18	19	20	21	22	23	24	25	26	27	28	29	30	31	32
Enable	<input type="checkbox"/>	<input type="checkbox"/>	<input type="checkbox"/>	<input type="checkbox"/>	<input type="checkbox"/>	<input type="checkbox"/>	<input type="checkbox"/>	<input type="checkbox"/>	<input type="checkbox"/>	<input type="checkbox"/>	<input type="checkbox"/>	<input type="checkbox"/>	<input type="checkbox"/>	<input type="checkbox"/>	<input type="checkbox"/>	<input type="checkbox"/>
Disable	<input type="checkbox"/>	<input type="checkbox"/>	<input type="checkbox"/>	<input type="checkbox"/>	<input type="checkbox"/>	<input type="checkbox"/>	<input type="checkbox"/>	<input type="checkbox"/>	<input type="checkbox"/>	<input type="checkbox"/>	<input type="checkbox"/>	<input type="checkbox"/>	<input type="checkbox"/>	<input type="checkbox"/>	<input type="checkbox"/>	<input type="checkbox"/>
Gage Shape:	17	18	19	20	21	22	23	24	25	26	27	28	29	30	31	32
Linear	<input type="checkbox"/>	<input type="checkbox"/>	<input type="checkbox"/>	<input type="checkbox"/>	<input type="checkbox"/>	<input type="checkbox"/>	<input type="checkbox"/>	<input type="checkbox"/>	<input type="checkbox"/>	<input type="checkbox"/>	<input type="checkbox"/>	<input type="checkbox"/>	<input type="checkbox"/>	<input type="checkbox"/>	<input type="checkbox"/>	<input type="checkbox"/>
Circular	<input type="checkbox"/>	<input type="checkbox"/>	<input type="checkbox"/>	<input type="checkbox"/>	<input type="checkbox"/>	<input type="checkbox"/>	<input type="checkbox"/>	<input type="checkbox"/>	<input type="checkbox"/>	<input type="checkbox"/>	<input type="checkbox"/>	<input type="checkbox"/>	<input type="checkbox"/>	<input type="checkbox"/>	<input type="checkbox"/>	<input type="checkbox"/>
*Gaging Mode:	17	18	19	20	21	22	23	24	25	26	27	28	29	30	31	32
Binary Mode	<input type="checkbox"/>	<input type="checkbox"/>	<input type="checkbox"/>	<input type="checkbox"/>	<input type="checkbox"/>	<input type="checkbox"/>	<input type="checkbox"/>	<input type="checkbox"/>	<input type="checkbox"/>	<input type="checkbox"/>	<input type="checkbox"/>	<input type="checkbox"/>	<input type="checkbox"/>	<input type="checkbox"/>	<input type="checkbox"/>	<input type="checkbox"/>
Gray Scale Mode	<input type="checkbox"/>	<input type="checkbox"/>	<input type="checkbox"/>	<input type="checkbox"/>	<input type="checkbox"/>	<input type="checkbox"/>	<input type="checkbox"/>	<input type="checkbox"/>	<input type="checkbox"/>	<input type="checkbox"/>	<input type="checkbox"/>	<input type="checkbox"/>	<input type="checkbox"/>	<input type="checkbox"/>	<input type="checkbox"/>	<input type="checkbox"/>
Sub Pixel Resolution	<input type="checkbox"/>	<input type="checkbox"/>	<input type="checkbox"/>	<input type="checkbox"/>	<input type="checkbox"/>	<input type="checkbox"/>	<input type="checkbox"/>	<input type="checkbox"/>	<input type="checkbox"/>	<input type="checkbox"/>	<input type="checkbox"/>	<input type="checkbox"/>	<input type="checkbox"/>	<input type="checkbox"/>	<input type="checkbox"/>	<input type="checkbox"/>
Gage Width: 1 Pixel	<input type="checkbox"/>	<input type="checkbox"/>	<input type="checkbox"/>	<input type="checkbox"/>	<input type="checkbox"/>	<input type="checkbox"/>	<input type="checkbox"/>	<input type="checkbox"/>	<input type="checkbox"/>	<input type="checkbox"/>	<input type="checkbox"/>	<input type="checkbox"/>	<input type="checkbox"/>	<input type="checkbox"/>	<input type="checkbox"/>	<input type="checkbox"/>
Gage Width: 3 Pixels	<input type="checkbox"/>	<input type="checkbox"/>	<input type="checkbox"/>	<input type="checkbox"/>	<input type="checkbox"/>	<input type="checkbox"/>	<input type="checkbox"/>	<input type="checkbox"/>	<input type="checkbox"/>	<input type="checkbox"/>	<input type="checkbox"/>	<input type="checkbox"/>	<input type="checkbox"/>	<input type="checkbox"/>	<input type="checkbox"/>	<input type="checkbox"/>
Gage Width: 5 Pixels	<input type="checkbox"/>	<input type="checkbox"/>	<input type="checkbox"/>	<input type="checkbox"/>	<input type="checkbox"/>	<input type="checkbox"/>	<input type="checkbox"/>	<input type="checkbox"/>	<input type="checkbox"/>	<input type="checkbox"/>	<input type="checkbox"/>	<input type="checkbox"/>	<input type="checkbox"/>	<input type="checkbox"/>	<input type="checkbox"/>	<input type="checkbox"/>
Gaging Operation:	17	18	19	20	21	22	23	24	25	26	27	28	29	30	31	32
Count White Pixels	<input type="checkbox"/>	<input type="checkbox"/>	<input type="checkbox"/>	<input type="checkbox"/>	<input type="checkbox"/>	<input type="checkbox"/>	<input type="checkbox"/>	<input type="checkbox"/>	<input type="checkbox"/>	<input type="checkbox"/>	<input type="checkbox"/>	<input type="checkbox"/>	<input type="checkbox"/>	<input type="checkbox"/>	<input type="checkbox"/>	<input type="checkbox"/>
Count Black Pixels	<input type="checkbox"/>	<input type="checkbox"/>	<input type="checkbox"/>	<input type="checkbox"/>	<input type="checkbox"/>	<input type="checkbox"/>	<input type="checkbox"/>	<input type="checkbox"/>	<input type="checkbox"/>	<input type="checkbox"/>	<input type="checkbox"/>	<input type="checkbox"/>	<input type="checkbox"/>	<input type="checkbox"/>	<input type="checkbox"/>	<input type="checkbox"/>
Count White Objects	<input type="checkbox"/>	<input type="checkbox"/>	<input type="checkbox"/>	<input type="checkbox"/>	<input type="checkbox"/>	<input type="checkbox"/>	<input type="checkbox"/>	<input type="checkbox"/>	<input type="checkbox"/>	<input type="checkbox"/>	<input type="checkbox"/>	<input type="checkbox"/>	<input type="checkbox"/>	<input type="checkbox"/>	<input type="checkbox"/>	<input type="checkbox"/>
Count Black Objects	<input type="checkbox"/>	<input type="checkbox"/>	<input type="checkbox"/>	<input type="checkbox"/>	<input type="checkbox"/>	<input type="checkbox"/>	<input type="checkbox"/>	<input type="checkbox"/>	<input type="checkbox"/>	<input type="checkbox"/>	<input type="checkbox"/>	<input type="checkbox"/>	<input type="checkbox"/>	<input type="checkbox"/>	<input type="checkbox"/>	<input type="checkbox"/>
Count Edges	<input type="checkbox"/>	<input type="checkbox"/>	<input type="checkbox"/>	<input type="checkbox"/>	<input type="checkbox"/>	<input type="checkbox"/>	<input type="checkbox"/>	<input type="checkbox"/>	<input type="checkbox"/>	<input type="checkbox"/>	<input type="checkbox"/>	<input type="checkbox"/>	<input type="checkbox"/>	<input type="checkbox"/>	<input type="checkbox"/>	<input type="checkbox"/>
Measure Line Length	<input type="checkbox"/>	<input type="checkbox"/>	<input type="checkbox"/>	<input type="checkbox"/>	<input type="checkbox"/>	<input type="checkbox"/>	<input type="checkbox"/>	<input type="checkbox"/>	<input type="checkbox"/>	<input type="checkbox"/>	<input type="checkbox"/>	<input type="checkbox"/>	<input type="checkbox"/>	<input type="checkbox"/>	<input type="checkbox"/>	<input type="checkbox"/>
X Position	<input type="checkbox"/>	<input type="checkbox"/>	<input type="checkbox"/>	<input type="checkbox"/>	<input type="checkbox"/>	<input type="checkbox"/>	<input type="checkbox"/>	<input type="checkbox"/>	<input type="checkbox"/>	<input type="checkbox"/>	<input type="checkbox"/>	<input type="checkbox"/>	<input type="checkbox"/>	<input type="checkbox"/>	<input type="checkbox"/>	<input type="checkbox"/>
Y Position	<input type="checkbox"/>	<input type="checkbox"/>	<input type="checkbox"/>	<input type="checkbox"/>	<input type="checkbox"/>	<input type="checkbox"/>	<input type="checkbox"/>	<input type="checkbox"/>	<input type="checkbox"/>	<input type="checkbox"/>	<input type="checkbox"/>	<input type="checkbox"/>	<input type="checkbox"/>	<input type="checkbox"/>	<input type="checkbox"/>	<input type="checkbox"/>
Measure Chord Angle (circular gage only)	<input type="checkbox"/>	<input type="checkbox"/>	<input type="checkbox"/>	<input type="checkbox"/>	<input type="checkbox"/>	<input type="checkbox"/>	<input type="checkbox"/>	<input type="checkbox"/>	<input type="checkbox"/>	<input type="checkbox"/>	<input type="checkbox"/>	<input type="checkbox"/>	<input type="checkbox"/>	<input type="checkbox"/>	<input type="checkbox"/>	<input type="checkbox"/>
Measure Wedge Angle (circular gage only)	<input type="checkbox"/>	<input type="checkbox"/>	<input type="checkbox"/>	<input type="checkbox"/>	<input type="checkbox"/>	<input type="checkbox"/>	<input type="checkbox"/>	<input type="checkbox"/>	<input type="checkbox"/>	<input type="checkbox"/>	<input type="checkbox"/>	<input type="checkbox"/>	<input type="checkbox"/>	<input type="checkbox"/>	<input type="checkbox"/>	<input type="checkbox"/>

*Note: Sub Pixel Resolution and Gage Width apply only to Gray Scale Mode.

**Configuration Planning
Tables (continued)**

Gage Parameters: Tool Set # __ (Part 5 of 6)								
Gage Number	Output Line		Gage Number	Output Line		Gage Number	Output Line	
	Range	*Line Number		Range	*Line Number		Range	*Line Number
1	Fault Warn.	_____ _____	12	Fault Warn.	_____ _____	23	Fault Warn.	_____ _____
2	Fault Warn.	_____ _____	13	Fault Warn.	_____ _____	24	Fault Warn.	_____ _____
3	Fault Warn.	_____ _____	14	Fault Warn.	_____ _____	25	Fault Warn.	_____ _____
4	Fault Warn.	_____ _____	15	Fault Warn.	_____ _____	26	Fault Warn.	_____ _____
5	Fault Warn.	_____ _____	16	Fault Warn.	_____ _____	27	Fault Warn.	_____ _____
6	Fault Warn.	_____ _____	17	Fault Warn.	_____ _____	28	Fault Warn.	_____ _____
7	Fault Warn.	_____ _____	18	Fault Warn.	_____ _____	29	Fault Warn.	_____ _____
8	Fault Warn.	_____ _____	19	Fault Warn.	_____ _____	30	Fault Warn.	_____ _____
9	Fault Warn.	_____ _____	20	Fault Warn.	_____ _____	31	Fault Warn.	_____ _____
10	Fault Warn.	_____ _____	21	Fault Warn.	_____ _____	32	Fault Warn.	_____ _____
11	Fault Warn.	_____ _____	22	Fault Warn.	_____ _____			

*Enter the appropriate output line number for the Fault and Warning ranges. You can assign the same number or different numbers for each ranges. Use only those output line numbers that you have assigned a "1/Results" or "2/Results" function.

**Configuration Planning
Tables (continued)**

Window Parameters: Tool Set # <u> </u> (Part 3 of 4)								
Window Number	Output Line		Window Number	Output Line		Window Number	Output Line	
	Range	*Line Number		Range	*Line Number		Range	*Line Number
1	Fault Warn.	_____ _____	9	Fault Warn.	_____ _____	17	Fault Warn.	_____ _____
2	Fault Warn.	_____ _____	10	Fault Warn.	_____ _____	18	Fault Warn.	_____ _____
3	Fault Warn.	_____ _____	11	Fault Warn.	_____ _____	19	Fault Warn.	_____ _____
4	Fault Warn.	_____ _____	12	Fault Warn.	_____ _____	20	Fault Warn.	_____ _____
5	Fault Warn.	_____ _____	13	Fault Warn.	_____ _____	21	Fault Warn.	_____ _____
6	Fault Warn.	_____ _____	14	Fault Warn.	_____ _____	22	Fault Warn.	_____ _____
7	Fault Warn.	_____ _____	15	Fault Warn.	_____ _____	23	Fault Warn.	_____ _____
8	Fault Warn.	_____ _____	16	Fault Warn.	_____ _____	24	Fault Warn.	_____ _____

*Enter the appropriate output line number(s) for the Fault and Warning ranges. You can assign the same number or different numbers for each range. Use only those output line numbers that you have assigned a "1/Results" or "2/Results" function.

Appendix **C** Definition of Terms

Appendix Objective The objective of this appendix is to define the terms used in this manual that have a special meaning for machine vision and/or the CVIM system.

Definition of Terms

Active Tool Set – The active tool set is the one that is currently displayed for configuration purposes. It is selectable by a menu box of the same name.

Analysis Function – This function enables you to determine the processing time for the tools used in your application.

Analysis Tool – An analysis tool is any one of the CVIM system's tools, and includes the inspection tools (gages and windows), the reference tools (lines or windows) and the light probes.

Binary Image – This is an area in the screen image in which all parts of the image are either black or white. For a gage operating in the binary gaging mode, it is the area immediately around the gage. For a window operating in a pixel-counting or object-counting mode, it is the entire area within the window's boundaries.

Brightness Compensation – Brightness compensation is the result of light probe operation. It minimizes changes in gray scale image data under varying lighting conditions.

CVIM – This is the abbreviation for Configurable Vision Input Module. It is the vision processing module designed for the Allen-Bradley Pyramid Integrator chassis.

Discrete I/O Lines – These are the 16 lines that carry electrical signals between the CVIM system and your production equipment. The two input lines carry "trigger" signals, which initiate inspection cycles. The 14 output lines carry the "pass/fail" inspection results and status, which the production equipment can use to process the workpiece being inspected.

Drag – This is the name for moving the analysis tools around on the monitor screen. Before "dragging" a tool, you must first "pick" the tool.

Edge – An edge is a transition along a gage's length. Operating in the binary gaging mode, the gage looks for a transition from black to white, or vice versa. In the gray scale gaging mode, the gage looks for a transition from one shade of gray to another over a specified number of pixels.

Definition of Terms
(continued)

Filter – The adjustable filter function removes unwanted visual “noise” from a binary image for gages operating in the binary gaging mode and windows operating in the pixel- or object-counting modes.

Freeze Function – This function applies to the run mode. When the freeze function is enabled (and armed), the CVIM system will freeze the screen image when the appropriate condition occurs. In all cases, the CVIM system will continue its inspection operations. The last image – the one with the freeze-causing condition – will be “frozen” on the monitor screen.

You can “arm” the system to freeze the screen image for one of three freeze conditions, as follows:

- **Freeze on First Reject** – The screen image will freeze when a reject-causing condition occurs, such as a window pixel count being outside range limits.

Since inspection operations will continue, other reject-causing conditions could occur; however, they will not be displayed. Only the image from the *first* reject-causing condition will be displayed. It will remain on the screen until you pick the Resume menu box in the runmode menu.

- **Freeze on All Rejects** – The screen image will freeze whenever a reject-causing condition occurs.

Inspection operations will continue; however, the image from the *most recent* reject-causing condition will remain on the screen until you pick the Resume menu box in the runmode menu.

- **Freeze on Next Inspection** – The screen image will freeze after the next inspection cycle, regardless of whether a reject-causing condition has occurred. When you pick the Resume menu box in the runmode menu, the screen image will freeze again after the *next* inspection cycle. This process will continue until you pick one of the other freeze condition menu boxes or the Go on Reject menu box.

Gage – A gage is one of 32 one-dimensional inspection tools within each tool set. Each gage can be set to any length, position, or angular orientation within the screen image, and can perform a variety of measurement and counting inspection tasks. A gage performs its inspection functions by detecting edges or counting black or white pixels on a workpiece.

Gaging Mode – The gaging mode is the means by which a gage detects edges.

In the *binary* gaging mode, features on the workpiece change to either black or white. To detect an edge, the gage looks for a transition from black to white, or vice versa.

In the *gray scale* gaging mode, features on the workpiece remain in gray scale form. To detect an edge, the gage looks for a transition from one shade of gray to another shade of gray over a specified number of pixels.

Definition of Terms
(continued)

Gray Scale Image – This is the “digitized” screen image in its original form, in which each pixel has a brightness value ranging from 0 (zero) for the darkest to 63 for the lightest.

Grid Calibration – This function, which applies only to linear and circular gaging operations, compensates for the X/Y aspect ratio *and optical distortions*. It uses multiple reference points, derived from a special grid pattern, as the basis of the compensation calculation. At the same time, it calibrates gage measurements so that the “results” values of the gage operation appear in the specified “world” units; that is, inches, centimeters, or pixels.

Halt Function – This function applies to the run mode. When the halt function is enabled (and armed), the CVIM system will halt all inspection operations when a reject-causing condition occurs, such as a gage measurement being outside the range limits. The last image – the one with the reject-causing condition – will be “frozen” on the monitor screen and all processing will stop.

You can resume CVIM inspection operations by picking the Resume menu box in the runmode menu.

Host – The host is the system that you designate to have primary control of the CVIM system’s operations. The host system can be an externally connected PLC (programmable logic controller) or computer, or an Allen-Bradley Pyramid Integrator controller or computer residing in the same chassis with the CVIM module.

Image Resolution – This parameter determines the image resolution, in pixels, for three ranges: 256 horizontal pixels by 256 vertical pixels, 512 horizontal pixels by 256 vertical pixels, and 512 horizontal pixels by 512 vertical pixels. The finer the resolution, the greater the time required to process the image.

You should always set the image resolution *first* before configuring the reference and inspection tools.

Inspection Tool – An inspection tool is one of 32 gages and 24 windows within each tool set. These are the main tools that the CVIM system uses to measure, count, or otherwise evaluate a workpiece. The “results” values of these tools following an inspection operation are used to determine whether the workpiece passed or failed the inspection.

I/O Page – This is a display “page” that you can activate during the run mode. The I/O page shows, in summary form, the “pass/warning/fail” status of all enabled analysis tools.

In addition, the I/O page shows the “on/off” status of all discrete output lines that have been assigned a “results” function, and to which one or more enabled tools are assigned.

Definition of Terms
(continued)

Learn Function – This function, when activated, causes the currently selected tool to perform one inspection cycle and return the “results” data. The results data varies according to the tool’s assigned operation.

To activate the learn function, you must pick the Learn menu box associated with the specific analysis tool. The results data appear in the Learn menu box.

Learn Mode – The learn mode, when enabled, causes the CVIM system to accumulate “results” statistics from the analysis tools when the system is in the run mode.

Light Pen – The light pen is one of the two main elements of the user interface. Its tip contains a light sensor and switch. When you press the tip against a graphic symbol on the monitor screen – that is, when you “pick” the symbol – the sensor and switch send signals to the CVIM system. The action that follows depends on the symbol you picked.

Light Probe – This is a small box-shaped analysis tool that measures the average luminance or brightness within a user-designated reference area within the screen image. It determines whether the brightness level from the lighting has changed, and, if so, compensates the gray scale image prior to tool processing.

Mask – A mask is a special window function that removes or “masks” an unwanted portion of the image area within a window. This has the effect of reducing the visual clutter or “noise” within the window’s boundaries.

Menu Box – This is the name for one of the small rectangular boxes appearing on the monitor screen. Each box has a name or abbreviation that represents a specific configuration parameter or function, or a runmode parameter or function. To select the parameter or function, you “pick” the menu box with the light pen.

Noise – This is the term for unwanted pixels, or small clusters of pixels, along a gage operating in the binary gaging mode or a window operating in the pixel- or object-counting mode.

Noise consists of either white pixels on a black field or black pixels on a white field. Usually, you can remove all or most of the noise using the threshold and/or filter functions.

Object Calibration – This function, which applies to linear and circular gaging operations, compensates for the X/Y aspect ratio. It uses four reference points as the basis of the compensation calculation. At the same time, it calibrates gage measurements so that the “results” values of the gage operation appear in the specified “world” units; that is, inches, centimeters, or pixels.

Definition of Terms
(continued)

Output Line Function – This is one of the six types of signalling functions that you can assign to an output line.

Pick – This is the name for pressing the light pen tip against a graphic symbol on the monitor screen for the purpose of selecting that symbol. The action that follows depends on which symbol is picked.

Pick and Place – This is the name for “picking” a tool, “dragging” the tool to a different location, and locking or “placing” the tool at its new location.

Pixel – This is the term for one of the thousands of discrete picture elements that form the screen image. The term is derived from PICTURE + X + ELEMENT.

The CVIM module *digitizes* the analog signal from the camera; that is, it assigns a discrete value to each pixel ranging from 0 (zero) for the darkest to 63 for the lightest parts of the camera image.

Pixel Tolerance – This parameter applies to a window configured for template operation. The pixel tolerance is the amount by which the brightness value of each pixel in a workpiece image can vary from the brightness value of the corresponding pixel in the “template,” or stored image of the workpiece, and still be counted as acceptable.

Thus, if a pixel’s brightness value varies *within* the pixel tolerance range, the window accepts the pixel. If a pixel’s brightness value deviates *outside* the tolerance range, the window counts it as a “failed” pixel.

As an example, if you set the pixel tolerance to 5, and the brightness value of a pixel in the stored image were 30, the brightness value of the corresponding pixel in a workpiece image would be acceptable if it were within the range from 25 to 35 ($30 - 5 = 25$, and $30 + 5 = 35$).

You can set the pixel tolerance to any number from 3 to 63.

At one extreme, if the pixel tolerance were set to 3, the pixels in the workpiece image could vary only by ± 3 . At the other extreme, if the pixel tolerance were set to 63, *any* pixel in the workpiece image would be acceptable. Thus, the window would “accept” *any* image.

Popup Menu – When you pick a menu box during the configuration mode, one or more menus may “pop up” somewhere on the monitor screen. You can use these popup menus to perform functions and enter tool parameters.

Range Limit – A range limit is a value that you specify as a maximum or minimum permissible value for the “results” data from an analysis tool following an inspection operation. Range limits are used to indicate whether a workpiece passed or failed an inspection.

Definition of Terms
(continued)

Reference Line – A reference line is one of three pairs of one-dimensional reference tools within each tool set. Each of the three pairs consists of an X-axis line and a Y-axis line, which can be used alone or together.

The sole purpose of each reference line is to locate a specified point of interest on a workpiece and determine whether that point of interest has shifted from the position of the same edge on the original workpiece. If so, the reference line provides shift compensation to all associated inspection tools.

Reference Tool – A reference tool (line or window) compensates for shift and/or rotation of the workpiece within the screen image. It detects the amount that a workpiece has shifted and/or rotated from the *original* workpiece position, and shifts and/or rotates the inspection tools by that amount. The result is that the tools maintain the same relative position over the shifted workpiece that they had over the original workpiece.

Reference Window – A reference window is one of three sets of two-dimensional reference tools within each tool set. Each of the three sets consists of three search/feature window pairs.

The sole purpose of each reference window is to locate one or more specified features on a workpiece and determine whether the feature(s) has shifted and/or rotated from the position of the same feature(s) on the original workpiece. If so, the reference window provides shift and/or rotation compensation to all associated inspection tools.

Registration Function – This function enables you to automatically reposition all tools associated with reference tools whenever the workpiece location has changed in the screen image. This can save considerable time compared to repositioning all tools *manually*.

Results Page – This is a display “page” that you can activate during the run mode. The results page shows the accumulation of faults for all analysis tools, and shows the current “results” value for each enabled inspection tool. The page also shows the number of triggers accepted and missed.

Score and Set Score – These terms apply to reference windows, as follows:

- *Score* is the “results” value that a feature window accumulates during an inspection operation as it looks for a specific workpiece feature within a search window.
- *Set score* is a parameter that you set during system configuration. It determines the acceptable limit of the score “results” value, and thus determines the point beyond which the reference window is considered to have failed to “find” the workpiece feature.

Definition of Terms
(continued)

Score and Set Score (continued) – For example, if you set the *set score* parameter to 25, and during an inspection operation a feature window finds a feature whose score is 20, the reference window operation is considered to be *successful*. As a consequence, the reference window can supply position compensation to its associated inspection tools, and the tools can perform their inspections.

If, on the other hand, the lowest score that the feature window can find is 30, the reference window operation is considered *unsuccessful*. As a consequence, the reference window *cannot* supply position compensation to its associated inspection tools, and the tools *cannot* perform their inspections.

If two or three feature/search window pairs in a reference window are “active,” *all* must “find” their respective features on the workpiece for the reference window operation to succeed. If any one fails, the whole reference window fails.

Standard Mode – The standard mode, when enabled, inhibits the CVIM system from accumulating “results” statistics from the analysis tools when the system is in the run mode.

Statistics Pages – These are two separate display “pages” that you can activate during the run mode. The Stat 1 page shows the accumulated statistical data based on the number of trial inspections and the “results” values from the enabled inspection tools. The Stat 2 page shows the accumulated statistical data based on the number of inspections and the “results” values from the enabled reference windows.

You can reset that data in the statistics pages by pressing the Reset Stat’s menu box in the runmode menu.

Sub Pixel – This function enables a gage to locate an edge to better than one-pixel accuracy. The sub pixel function is available only for a gage operating in the gray scale gaging mode and performing linear gaging.

Template – This is a stored image of a workpiece or part of a workpiece. When a window is configured for “template” operation, during an inspection operation the window compares the image of the current workpiece (the one being inspected) to the stored image.

Test Pattern – The test pattern is a geometric array of gray-scale shaded vertical bars and binary figures on the monitor screen. It appears after a successful system powerup and whenever you “pick” a menu box called Display Test Image.

Definition of Terms
(continued)

Threshold – This is an adjustable numerical reference that determines which parts of a gray scale image become either white or black. You can adjust the threshold according to the needs of the application.

The threshold setting is used for gages operating in the binary gaging mode and windows operating in the pixel- or object-counting modes.

You can adjust the amount of filtering according to the needs of the application.

Tool Set – A tool set is a complete set of inspection tools (gages and windows) and reference tools (lines and windows). The CVIM system has two sets of tools, each of which can be separately triggered. In addition, each tool set can be associated with the same camera image or different camera images.

Trigger Source – The trigger source is the point of origin of the signal that starts an inspection cycle when the CVIM system is in the run mode. The source can be either internal to the CVIM module, or external. The internal trigger recurs automatically at a fixed rate. The external trigger, whether directly from a presence-sensing switch or sensor, or indirectly from a host system, recurs as dictated by events at the switch or within the host system.

Units or World Units – The units or "world" units parameter determines how the "results" values from linear or circular gaging operations are reported. These units can be specified as inches, centimeters, or pixels. This parameter is used in conjunction with the calibration functions.

User Interface – The CVIM User Interface is the means by which you, the user, interact with the CVIM system for configuring and running the system. The main user interface tools are the light pen and the graphic figures on the video monitor screen.

Window – A window is one of 24 two-dimensional inspection tools within each tool set. Each window can be set to any size or position within the screen image, and can perform a variety of measurement, counting, and feature-evaluation inspection tasks. A window performs its inspection functions by evaluating the pixels within its boundaries.

Workpiece – This is the name for an item that the CVIM system is to inspect.

During an inspection operation, the camera acquires an image of the workpiece. One or more inspection tools then measure, count, or evaluate the workpiece, or some part of it, and report the "results." If the results data are within specified range limits, the workpiece passes the inspection; otherwise, it fails the inspection.

Index

<i>Section</i>	<i>Page</i>
A	
AC voltage selection switch	2-2
AC voltage specifications	2-3
Acquire single camera image	9-15
Acquire test image	9-15
Active feature selection, Gage	7-38
Active feature selection, Reference line	6-26
Active feature selection, Reference window	6-52
Active reference line selection	6-14
Active tool set selection	4-20
C	
Calibration, Description of	5-25
Calibration function grid calibration	5-48
Calibration function object calibration	5-34
Camera power supply connections	2-8, 9
Camera type selection	5-5
Camera/Tool Set selection	4-16, 18
Chassis backplane	1-3
Chassis power supply connections	2-3
Circular gage examples	7-6, 7, 8
Circular gage picking and placing	7-23
Component catalog numbers	2-1, 6, 7, 8
D	
DC power loading	2-4, 5
DC voltage selection switch	2-4
Dimensions, Grid calibration	5-46
Dimensions, Object calibration	5-34
E	
Edge definition, Gage (binary mode)	7-32
Edge definition, Gage (gray scale mode)	7-35
Edge definition, Grid calibration	5-44
Edge definition, Object calibration	5-33
Edge definition, Reference line (binary mode)	6-20
Edge definition, Reference line (gray scale mode) ...	6-23
F	
Feature window display function	6-59
Feature window picking and placing	6-53
Find feature function	6-67
Focus camera function	5-6
Freeze status selection	10-4
G	
Gage number selection	7-10
Gage operation selection	7-12
Gage output line assignments	7-52
Gage range limit assignments	7-51

<i>Section</i>	<i>Page</i>
G (continued)	
Gage reference tool assignment	7-54
Gage shape selection	7-11
Gaging mode selection, Binary/Gray Scale	7-14
Gradient selection	8-40
Grid calibration picking and placing	5-38
H	
Halt status selection	10-4
Help message function	3-11
Hosted operating mode 1-3, 4-3	
I	
Image processing time, Determination of	9-18
L	
Learn function gages	7-45
Learn function, Light probe	5-18
Learn function, Reference line	6-34
Learn function, Reference window	6-68
Learn function, Window	8-46
Learn tool registration	9-23
Light pen operations	3-2
Light probe learn function	5-18
Light probe output line assignments	5-23
Light probe picking and placing	5-15
Light probe range limit assignments	5-22
Light probe status selection	5-14
Light reference threshold adjustment	5-10
Linear gage examples	7-3, 4
Linear gage picking and placing	7-16
Loading configuration from internal memory	9-6
Loading configuration/image from RAM card	9-13
Loading default configuration	9-7
M	
Menu removal function	3-11
Menus, Description of	3-4
Monitor selection, Color or BW	4-5
N	
Naming configurations and images	9-4
O	
Object calibration picking and placing	5-27
Offset function, Gage	7-43
Offset function, Reference line	6-31
Output enable/disable	10-5
Output line assignments, Gage	7-52
Output line assignments, Light probe	5-23
Output line assignments, Reference line	6-35

<i>Section</i>	<i>Page</i>
O	
Output line assignments, Reference window	6-71
Output line assignments, Window	8-53
Output line connection data	A-8
Output line function assignments	4-8
Output line planning sheet	A-12
Output line planning sheet considerations	A-1
Output signal timing data	A-5
P	
Power supply specifications 1-4	
R	
RAM card battery change	9-10, 11
RAM card formatting	9-11, 12
RAM card, loading configuration/image from	9-13
RAM card preparation	9-9
RAM card, Saving configuration/image to	9-12
Range limit assignments, Gage	7-51
Range limit assignments, Light probe	5-22
Range limit assignments, Window	8-52
Reference line, Binary/Gray Scale mode	6-15
Reference line example	6-3
Reference line learn function	6-34
Reference line number selection	6-9
Reference line output line assignments	6-35
Reference line picking and placing	6-16
Reference line reference tool assignment	6-36
Reference line type, Description	6-10
Reference line type selection	6-10
Reference tool assignment, Gage	7-54
Reference tool assignment, Reference line	6-36
Reference tool assignment, Reference window	6-73
Reference tool assignment, Window	8-55
Reference window learn function	6-68
Reference window number selection	6-51
Reference window output line assignments	6-71
Reference window reference tool assignment	6-73
Reference window set score function	6-60
Remote I/O parameter selection	4-13
Remote I/O port	1-3
Reset counters function	10-6
Resolution camera image	5-8
RS-232 parameter selection	4-12
RS-232 port	1-3
Runmode display selection	10-7, 10
Runmode halt/freeze functions, Using	10-21
Runmode halt/freeze functions, Using	10-6, 21
Runmode I/O page, Description of	10-12
Runmode results page, Description of	10-16
Runmode statistics page, Description of	10-19, 20

<i>Section</i>	<i>Page</i>
S	
Saving configuration to internal memory	9-6, 10-9
Saving configuration/image to RAM card	9-12
Search direction selection, Gage	7-38
Search direction selection, Reference line	6-26
Search mode selection, Gage	7-39
Search mode selection, Reference line	6-27
Search window picking and placing	6-59
Set score function, Description of	6-60
Set score function, Using	6-66
Set score value, Determination of	6-61
Shutter parameter selection	5-5
Snapshot function	9-15
Standalone operating mode 1-3, 4-3	
Standard/Learn operating mode selection	10-5
Symbols, Monitor screen	3-8
T	
Tables, Description of	3-6
Test image display function	9-15
Threshold/Filter function	8-34, 39
Tool display, Analysis mode	9-17
Tool display, Configuration mode	4-5
Tool display, Registration mode	9-21
Tool display, Run mode	10-7, 10
Tool registration function	9-22, 23
Tool set display selection	10-21
Trigger source selection	4-16, 18
U	
Units selection	4-6
V	
Variable data, creating messages with	11-2
Vernier arrows, Circular gages	7-31
Vernier arrows, Grid calibration	5-43
Vernier arrows, Light probe	5-17
Vernier arrows, Linear gages	7-20
Vernier arrows, Object calibration	5-32
Vernier arrows, Reference lines	6-19
Vernier arrows, Reference windows	6-57
Vernier arrows, Windows	8-25
W	
Warning symbol	1-3
Window examples	8-3, 5, 7, 9, 10
Window mask picking and placing	8-27
Window mask selection	8-26
Window number selection	8-12
Window operation, Gradient	8-37
Window operation, Object counting	8-30

<i>Section</i>	<i>Page</i>
Window operation, Selection	8-28
Window operation, Template match	8-43
Window output line assignments	8-53
Window picking and placing	8-15
Window range limit assignments	8-52
Window reference tool assignment	8-55
Window shape selection	8-13



Allen-Bradley, a Rockwell Automation Business, has been helping its customers improve productivity and quality for more than 90 years. We design, manufacture and support a broad range of automation products worldwide. They include logic processors, power and motion control devices, operator interfaces, sensors and a variety of software. Rockwell is one of the world's leading technology companies.

Worldwide representation.



Argentina • Australia • Austria • Bahrain • Belgium • Brazil • Bulgaria • Canada • Chile • China, PRC • Colombia • Costa Rica • Croatia • Cyprus • Czech Republic • Denmark Ecuador • Egypt • El Salvador
Finland • France • Germany • Greece • Guatemala • Honduras • Hong Kong • Hungary • Iceland • India • Indonesia • Ireland • Israel • Italy Jamaica • Japan • Jordan • Korea • Kuwait • Lebanon
Malaysia • Mexico • Netherlands • New Zealand • Norway • Pakistan • Peru • Philippines • Poland • Portugal Puerto Rico • Qatar • Romania • Russia-CIS • Saudi Arabia • Singapore • Slovakia
Slovenia • South Africa, Republic • Spain • Sweden • Switzerland • Taiwan • Thailand Turkey • United Arab Emirates • United Kingdom • United States • Uruguay • Venezuela • Yugoslavia

Allen-Bradley Headquarters, 1201 South Second Street, Milwaukee, WI 53204 USA, Tel: (1) 414 382-2000 Fax: (1) 414 382-4444