

Bus Terminal

The modular fieldbus system for automation

490 Bus Couplers



516 Bus Terminals

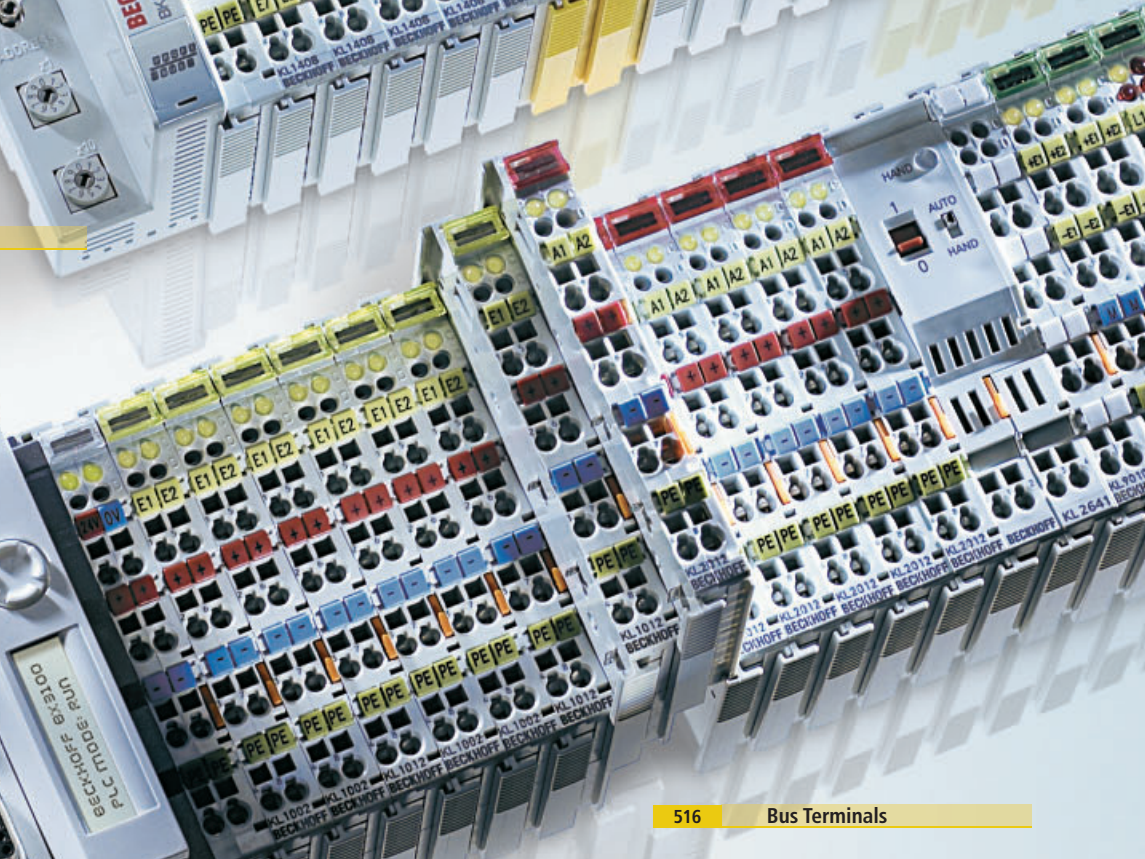

506 Bus Terminal Controllers



Bus Terminal

Independence from signals and fieldbuses with one system

464	System overview
466	Product overview
476	System description
480	Features
486	Technical data

490 Bus Couplers

492	EtherCAT BK1120, BK1250
493	Lightbus BK2xx0
494	PROFIBUS BK3xx0, LC3100
496	Interbus BK4xx0
497	CANopen BK51xx, LC5100
498	DeviceNet BK52x0, LC5200
500	ControlNet BK7000
500	CC-Link BK7150
501	Modbus BK73x0
501	Fipio BK7420
502	SERCOS interface BK75x0
502	RS232/RS485 BK8x00
503	Ethernet TCP/IP BK9xx0
504	PROFINET BK9xx3
505	EtherNet/IP BK9x05
505	USB BK9500

506 Bus Terminal Controllers

508	Lightbus BC2000
508	PROFIBUS BC31x0, BX3100
509	Interbus BC4000
509	CANopen BC5150, BX5100
510	DeviceNet BC5250, BX5200
511	Modbus BC7300
511	RS232/RS485 BC8xx0, BX8000
513	Ethernet TCP/IP BC9xx0, BX9000

516 Bus Terminals digital I/O

518	Digital input KL1xxx, KS1xxx, KM1xxx
532	Digital output KL2xxx, KS2xxx, KM2xxx

554 Bus Terminals analog I/O

554	Analog input KL3xxx, KS3xxx, KM37xx
572	Analog output KL4xxx, KS4xxx, KM4602

580 Bus Terminals special functions

580	Position measurement KL5xxx, KS5xxx
584	Communication, master terminals KL6xxx, KS6xxx, KM6551
592	Power terminals KL8xxx

531 Safety terminals

531	TwinSAFE terminals KLx904
-----	---------------------------

594 System terminals

594	System terminals KL9xxx, KS9xxx
605	Special terminals KLxxxx, KSxxxx









608 Accessories





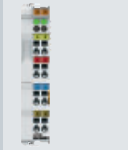

608	Connectors and cables
611	Assembly aids
612	Marking material
613	Demokits
614	Accessories radio technology

715 Software

716	Configuration software KS2000
794	Programming system TwinCAT

System overview Bus Couplers

	Bus Coupler					PLC		
Features	Standard BKxx00	Economy BKxx10	Economy plus BKxx20	Compact BKxx5x	Low Cost LCxx00	Controller BCxx00	BCxx50	BC9191
								
Function	fieldbus slave	fieldbus slave	fieldbus slave	fieldbus slave	fieldbus slave	fieldbus slave, with integrated IEC 61131-3 PLC	fieldbus slave, with integrated IEC 61131-3 PLC	Building Automation Room Controller
Program memory	–	–	–	–	–	32/96 kbyte	48 kbyte	48 kbyte
Power supply	1,750 mA	500 mA	1,750 mA	1,000 mA	500 mA	1,750 mA	1,000 mA	350 mA
Fieldbus connection	plug (design depends on the fieldbus)	plug (design depends on the fieldbus)	plug (design depends on the fieldbus)	plug (design depends on the fieldbus)	direct to the spring-loaded terminals	plug (design depends on the fieldbus)	plug (design depends on the fieldbus)	2 x RJ 45 (switched)
Supported Bus Terminals	all	only digital I/Os (except KL15xx, KL25xx, KL2692, KL27x1)	all	all	only digital I/Os (except KL15xx, KL25xx, KL2692, KL27x1)	all	all	all
Maximum number of Bus Terminals	64	64	64 (255 with terminal bus extension)	64 (255 with terminal bus extension)	64	64	64 (255 with terminal bus extension)	64 with terminal bus extension
Electrical isolation	between fieldbus/ power contacts/ supply voltage	between fieldbus/ power contacts/ supply voltage	between fieldbus/ power contacts/ supply voltage	between fieldbus/ power contacts/ supply voltage	PROFIBUS: yes, CANopen and DeviceNet: no	between fieldbus/ power contacts/ supply voltage	between fieldbus/ power contacts/ supply voltage	between fieldbus/ power contacts/ supply voltage

		Embedded PC					
BCxx20	BXxx00	CX80xx	CX9xxx	CX1010	CX50xx	CX1020, CX1030	
							
fieldbus slave, with integrated IEC 61131-3 PLC	fieldbus slave, with integrated IEC 61131-3 PLC	Embedded PC, fieldbus slave, with integrated IEC 61131-3 PLC	Embedded PC, with integrated IEC 61131-3 PLC, Motion Control, visualisation	Embedded PC, with integrated IEC 61131-3 PLC, Motion Control, visualisation	Embedded PC, with integrated IEC 61131-3 PLC, Motion Control, visualisation	Embedded PC, with integrated IEC 61131-3 PLC, Motion Control, visualisation	
128 kbyte	256 kbyte	64 Mbyte DDR2	64...128 Mbyte SDRAM	256 Mbyte DDR	512 Mbyte DDR2	256 Mbyte... 1 Gbyte DDR	
1,750 mA	1,450 mA	2,000 mA	2,000 mA	2,000 mA	2,000 mA	2,000 mA	
plug (design depends on the fieldbus)	plug (design depends on the fieldbus)	plug (design depends on the fieldbus)	–	optional, plug (design depends on the fieldbus)	optional, plug (design depends on the fieldbus)	optional, plug (design depends on the fieldbus)	
all	all	all	all	all	all	all	
64 (255 with terminal bus extension)	64 (255 with terminal bus extension)	64 (255 with terminal bus extension)	64 (255 with terminal bus extension)	64 (255 with terminal bus extension)	64 (255 with terminal bus extension)	64 (255 with terminal bus extension)	
between fieldbus/ power contacts/ supply voltage	between fieldbus/ power contacts/ supply voltage	between supply voltage and fieldbus	between supply voltage and fieldbus	between supply voltage and fieldbus	between supply voltage and fieldbus	between supply voltage and fieldbus	

Embedded PC see 168

Product overview Bus Couplers

Bus Coupler						PLC	
Fieldbus slave	Standard	Economy only digital I/Os	Economy plus	Compact	Low Cost only digital I/Os	Controller (IEC 61131-3)	
						Program memory 32/96 kbyte	Program memory 48 kbyte
EtherCAT			BK1120 492	BK1250 492			
LIGHTBUS	BK2000 493	BK2010 493	BK2020 493			BC2000 508	
PROFIBUS		BK3010 494 1.5 Mbaud					
	BK3100 494 12 Mbaud	BK3110 494 12 Mbaud	BK3120 495 12 Mbaud	BK3150 495 12 Mbaud	LC3100 495 12 Mbaud	BC3100 508 12 Mbaud	BC3150 508 12 Mbaud
	BK3500 495 1.5 Mbaud, fibre optic		BK3520 495 12 Mbaud, fibre optic				
INTERBUS	BK4000 496	BK4010 496	BK4020 496			BC4000 509	
	BK4500 497 fibre optic						
CANopen		BK5110 497	BK5120 497	BK5150 497 BK5151 498	LC5100 498		BC5150 509
DeviceNet	BK5200 498	BK5210 499	BK5220 499	BK5250 499	LC5200 499		BC5250 510
ControlNet	BK7000 500						
CC-Link				BK7150 500			
Modbus	BK7300 501			BK7350 501		BC7300 511	BC8050 511 BC8150 512
Fipio			BK7420 501				
SERCOS interface	BK7500 502		BK7520 502				
RS485	BK8000 502					BC8000 511	BC8050 511
RS232	BK8100 503					BC8100 512	BC8150 512
Ethernet TCP/IP	BK9000 503			BK9050 503		BC9000 513	BC9050 513
	BK9100 503 2-channel switch					BC9100 514	BC9191 515
PROFINET	BK9103 504 2-channel switch			BK9053 504			
EtherNet/IP	BK9105 505 2-channel switch			BK9055 505			
USB	BK9500 505						

		Embedded PC				
Program memory 128 kbyte	Program memory 256 kbyte	CX80xx	CX9xxx	CX1010	CX50xx	CX1020, CX1030
		CX8010 186			optional ⁽²⁾	
				optional ⁽¹⁾		optional ⁽¹⁾
	BX3100 509 12 Mbaud	CX8031 186		optional ⁽¹⁾	optional ⁽²⁾	optional ⁽¹⁾
	BX5100 510	CX8051 187		optional ⁽¹⁾	optional ⁽²⁾	optional ⁽¹⁾
	BX5200 510					
			optional ⁽³⁾	optional ⁽³⁾	optional ⁽³⁾	optional ⁽³⁾
	BX8000 512		optional ⁽²⁾	optional ⁽²⁾	optional ⁽²⁾	optional ⁽²⁾
	BX8000 512		optional ⁽²⁾	optional ⁽²⁾	optional ⁽²⁾	optional ⁽²⁾
BC9020 513 BC9120 514 2-channel switch	BX9000 515	CX8090 187	CX9000 190 CX9010 192	CX1010 198	CX5010 204 CX5020 204	CX1020 208 CX1030 210
		CX8093 187	optional ⁽³⁾	optional ⁽³⁾	optional ⁽²⁾	optional ⁽³⁾
		CX8095 187	optional ⁽³⁾	optional ⁽³⁾	optional ⁽²⁾	optional ⁽³⁾

⁽¹⁾ via modular fieldbus interface,

⁽²⁾ via system interface, ⁽³⁾ via software library

Product overview Bus Terminals

Digital input: KL1xxx KS1xxx			
Signal	2-channel		4-channel
5 V DC			KL1124 KS1124 524 filter 0.2 ms
24 V DC	KL1002 KS1002 521 filter 3.0 ms	KL1012 KS1012 521 filter 0.2 ms	KL1104 KS1104 520 filter 3.0 ms
	KL1052 KS1052 523 filter 3.0 ms, positive/negative switching		KL1114 KS1114 520 filter 0.2 ms
	KL1212 KS1212 520 filter 3.0 ms, short-circuit-protected sensor supply		KL1154 KS1154 523 filter 3.0 ms, positive/negative switching
			KL1164 KS1164 523 filter 0.2 ms, positive/negative switching
	KL1302 KS1302 521 filter 3.0 ms, type 2 sensors	KL1312 KS1312 521 filter 0.2 ms, type 2 sensors	KL1184 KS1184 522 filter 3.0 ms, negative switching
	KL1402 KS1402 521 filter 3.0 ms, type 3	KL1412 KS1412 521 filter 0.2 ms, type 3	KL1194 KS1194 522 filter 0.2 ms, negative switching
	KL1232 KS1232 528 pulse expansion		KL1304 KS1304 520 filter 3.0 ms, type 2 sensors
	KL1362 KS1362 529 break-in alarm		KL1314 KS1314 520 filter 0.2 ms, type 2 sensors
	KL1382 KS1382 529 thermistor		KL1404 KS1404 519 filter 3.0 ms, 4 x 2-wire connection
			KL1414 KS1414 519 filter 0.2 ms, 4 x 2-wire connection
			KL1434 KS1434 519 filter 0.2 ms, type 2 sensors, 4 x 2-wire connection
			KL1804 520 8 x 24 V, 4 x 0 V, filter 3.0 ms, type 3
			KL1814 520 8 x 24 V, 4 x 0 V, filter 0.2 ms, type 3
			KL1904 531 TwinSAFE, 4 safe inputs
≥ 48 V DC	KL1032 KS1032 524 filter 3.0 ms	KL1712-0060 525 power contacts	
120 V AC/DC	KL1712 KS1712 525 power contacts		
230 V AC	KL1702 KS1702 525 power contacts	KL1722 KS1722 525 no power contacts	
Namur	KL1352 KS1352 529		
Counter	KL1501 KS1501 530 up/down, 24 V DC, 100 kHz	KL1512 KS1512 530 up/down, 24 V DC, 1 kHz, 16 bit	

KLxxxx: Standard Bus Terminals, KSxxxx: Bus Terminals with pluggable wiring level
EN 61131-2 specification: www.beckhoff.com/EN61131-2

			KM1xxx		
8-channel		16-channel	4-, 16-, 32-, 64-channel		
KL1408 KS1408	518	KL1862	521	KM1002	526
filter 3.0 ms		filter 3.0 ms, flat-ribbon cable, type 3		filter 3.0 ms, 16-channel	
KL1418 KS1418	518	KL1862-0010	522	KM1012	526
filter 0.2 ms		filter 3.0 ms, flat-ribbon cable, type 3, negative switching		filter 0.2 ms, 16-channel	
		KL1872	521	KM1004	526
		filter 0.2 ms, flat-ribbon cable, type 3		filter 3.0 ms, 32-channel	
KL1488 KS1488	522			KM1014	526
filter 3.0 ms, negative switching				filter 0.2 ms, 32-channel	
KL1498 KS1498	522			KM1008	526
filter 0.2 ms, negative switching				filter 3.0 ms, 64-channel	
				KM1018	526
				filter 0.2 ms, 64-channel	
KL1808	519	KL1809	519		
8 x 24 V DC, filter 3.0 ms, type 3		filter 3.0 ms, type 3			
		KL1819	519		
		filter 0.2 ms, type 3			
		KL1859	519		
		8 inputs, 8 outputs, filter 3.0 ms, type 3, $I_{max} = 0.5 A$			
		KL1889	522	KM1644	527
		filter 3.0 ms, negative switching		manual operation, 4-channel	

Product overview Bus Terminals

Digital output: KL2xxx KS2xxx				
Signal	1-channel	2-channel	4-channel	
5 V DC			KL2124 KS2124 537	
24 V DC		KL2012 KS2012 535 <small>I_{MAX} = 0.5 A</small> KL2032 KS2032 534 <small>I_{MAX} = 0.5 A</small> KL2442 534 <small>2 x 4 A/1 x 8 A</small>	KL2022 KS2022 535 <small>I_{MAX} = 2.0 A</small> KL2212 KS2212 535 <small>I_{MAX} = 0.5 A, diagnostic, protected sensor supply</small>	KL2114 KS2114 534 <small>I_{MAX} = 0.5 A</small> KL2184 KS2184 538 <small>I_{MAX} = 0.5 A, negative switching</small> KL2404 KS2404 533 <small>I_{MAX} = 0.5 A, 4 x 2-wire</small> KL2904 537 <small>TwinSAFE, 4 safe outputs</small> KL2134 KS2134 534 <small>I_{MAX} = 0.5 A</small> KL2424 KS2424 533 <small>I_{MAX} = 2.0 A, 4 x 2-wire</small>
24 V AC/DC			KL2784 KS2784 539 <small>I_{MAX} = 2.0 A, solid state relay</small>	KL2794 KS2794 539 <small>I_{MAX} = 2.0 A, solid state relay</small>
125 V AC		KL2612 KS2612 540 <small>relay, change-over</small>		
230 V AC	KL2641 540 <small>relay, make contact, manual, 16 A</small> KL2751 KS2751 549 <small>universal dimmer, 300 W</small> KL2761 KS2761 549 <small>universal dimmer, 600 W</small> KL2701 KS2701 545 <small>solid state relay, 3 A</small>	KL2602 KS2602 541 <small>relay, make contact</small> KL2652 KS2652 541 <small>relay, change-over</small> KL2712 KS2712 544 <small>triac</small> KL2732 KS2732 544 <small>triac, mutually locked outputs, no power contacts</small>	KL2622 KS2622 541 <small>relay, make contact, no power cont.</small> KL2702 KS2702 545 <small>solid state relay, 0.3 A</small> KL2722 KS2722 544 <small>triac, mutually locked outputs</small> KL2692 KS2692 546 <small>cycle monitoring (watchdog)</small>	
400 V AC	KL2631 KS2631 541 <small>relay, make contact</small>			
PWM		KL2502 KS2502 548 <small>24 V DC, 0.1 A</small> KL2535 KS2535 548 <small>50 V DC, 3.5 A, current-controlled</small>	KL2512 KS2512 548 <small>24 V DC, 1.5 A, negative switching</small> KL2545 KS2545 548 <small>50 V DC, 3.5 A, current-controlled</small>	
Frequency outp.	KL2521 547			
Stepper motor	KL2531 KS2531 550 <small>I_{MAX} = 1.5 A</small> KL2541 KS2541 550 <small>I_{MAX} = 5 A</small>			
DC motor output stage		KL2532 KS2532 552 <small>24 V DC, 1 A</small>	KL2552 KS2552 552 <small>50 V DC, 5 A</small>	
AC motor speed controller	KL2791 KS2791 553 <small>230 V AC, 200 VA</small>			

KLxxxx: Standard Bus Terminals, KSxxxx: Bus Terminals with pluggable wiring level

		KM2xxx	
8-channel	16-channel	4-, 16-, 32-, 64-channel	
KL2408 KS2408 532 $I_{MAX} = 0.5\text{ A}$ KL2488 KS2488 538 $I_{MAX} = 0.5\text{ A}$, negative switching KL2808 533 $I_{MAX} = 0.5\text{ A}$, 8 x 0 V	KL2872 535 $I_{MAX} = 0.5\text{ A}$, flat-ribbon cable KL1859 533 8 inputs, 8 outputs, filter 3.0 ms, type 3, $I_{MAX} = 0.5\text{ A}$ KL2809 533 $I_{MAX} = 0.5\text{ A}$	KL2872-0010 538 $I_{MAX} = 0.5\text{ A}$, flat-ribbon cable, negative switching KL2889 538 $I_{MAX} = 0.5\text{ A}$, negative switching	KM2002 536 $I_{MAX} = 0.5\text{ A}$, 16-channel KM2004 536 $I_{MAX} = 0.5\text{ A}$, 32-channel KM2008 536 $I_{MAX} = 0.5\text{ A}$, 64-channel KM2042 535 $I_{MAX} = 0.5\text{ A}$, 16-channel, D-sub
			KM2604 542 relay, 16 A, 4-channel KM2642 543 relay, 6 A, manual/automatic operation, relay state readable KM2774 545 triac outputs for 4 blind motors
			KM2614 542 relay, 16 A, 4-channel, manual operation KM2652 543 relay, 6 A, manual/automatic operation, switch and relay state readable

Product overview Bus Terminals

Analog input: KL3xxx KS3xxx, KM3xxx				
Signal	1-channel	2-channel	4-channel	8-channel
0...2 V, 0...500 mV		KL3172 KS3172 557 0...2 V, 16 bit, 0.05 %	KL3172-0500 557 0...500 mV, 16 bit, 0.05 %	
± 2 V		KL3182 KS3182 557 16 bit, 0.05 %		
0...10 V	KL3061 KS3061 556 single-ended, 12 bit	KL3062 KS3062 556 single-ended, 12 bit KL3162 KS3162 557 16 bit, 0.05 %	KL3064 KS3064 556 single-ended, 12 bit KL3464 KS3464 556 single-ended, 12 bit	KL3468 KS3468 557 single-ended, 12 bit
± 10 V	KL3001 KS3001 554 differential input, 12 bit	KL3002 KS3002 554 differential input, 12 bit KL3102 KS3102 555 differential input, 16 bit	KL3132 KS3132 555 16 bit, 0.05 % KL3404 KS3404 555 single-ended, 12 bit	KL3408 KS3408 555 single-ended, 12 bit
0...20 mA	KL3011 KS3011 558 differential input, 12 bit	KL3041 KS3041 559 with sensor supply, 12 bit KL3012 KS3012 558 differential input, 12 bit KL3042 KS3042 559 with sensor supply, 12 bit	KL3112 KS3112 559 differential input, 16 bit KL3142 KS3142 559 16 bit, 0.05 %	KL3444 KS3444 558 single-ended, 12 bit KL3044 KS3044 558 single-ended, 12 bit
4...20 mA	KL3021 KS3021 560 differential input, 12 bit	KL3051 KS3051 561 with sensor supply, 12 bit KL3022 KS3022 560 differential input, 12 bit KL3122 KS3122 561 differential input, 16 bit	KL3052 KS3052 561 with sensor supply, 12 bit KL3152 KS3152 561 16 bit, 0.05 %	KL3454 KS3454 560 single-ended, 12 bit KL3054 KS3054 560 single-ended, 12 bit
Resistance thermometer (RTD)	KL3201 KS3201 562 PT100...1000, Ni100, 16 bit	KL3202 KS3202 563 PT100...1000, Ni100, 16 bit	KL3222 562 PT100, 4-wire connection, high-precision	KL3204 KS3204 563 PT100...1000, Ni100, 16 bit KL3208-0010 563 PT1000, Ni1000, PTC KL3228 KS3228 563 PT1000, Ni1000, PTC
Thermocouples/mV	KL3311 564 type J, K, L,...U, 16 bit	KL3312 565 type J, K, L,...U, 16 bit	KL3314 565 type J, K, L,...U, 16 bit	
Resistor bridge	KL3351 KS3351 566 strain gauge, 16 bit	KL3356 KS3356 566 strain gauge, 16 bit, self-calibration		
Oscilloscope	KL3361 KS3361 567 oscilloscope terminal, ±16 mV	KL3362 KS3362 567 oscilloscope terminal, ±10 V		
Measurement technology	KL3681 KS3681 569 digital multimeter terminal, 18 bit	KL3403 KS3403 568 3-phase power measurement terminal, 1 A	KL3403-0010 568 3-phase power measurement terminal, 5 A	
Pressure measuring	KM3701 570 differential pressure measuring, -100...+100 hPa	KM3701-0340 570 differential pressure measuring, up to 340 hPa	KM3702 571 relative pressure measuring, 7,500 hPa	KM3712 571 relative pressure measuring, -1,000...+1,000 hPa

KLxxx: Standard Bus Terminals, KSxxx: Bus Terminals with pluggable wiring level

Analog output: KL4xxx KS4xxx					KM4xxx
Signal	1-channel	2-channel	4-channel	8-channel	2-channel
0...10 V	KL4001 KS4001 574 12 bit, potential-free output	KL4002 KS4002 574 12 bit	KL4004 KS4004 574 12 bit KL4404 KS4404 575 12 bit	KL4408 KS4408 575 12 bit	KM4602 575 manual/automatic operation
± 10 V	KL4031 KS4031 572 12 bit, potential-free output	KL4032 KS4032 572 12 bit KL4132 KS4132 573 16 bit	KL4034 KS4034 573 12 bit KL4434 KS4434 573 12 bit KL4494 KS4494 573 2 x input, 2 x output, 12 bit	KL4438 KS4438 573 12 bit	
0...20 mA	KL4011 KS4011 576 12 bit	KL4012 KS4012 576 12 bit KL4112 KS4112 577 16 bit	KL4414 KS4414 577 12 bit	KL4418 KS4418 577 12 bit	
4...20 mA	KL4021 KS4021 578 12 bit	KL4022 KS4022 578 12 bit	KL4424 KS4424 579 12 bit	KL4428 KS4428 579 12 bit	

Product overview Bus Terminals

Special functions: KL KS5xxx, KL KS6xxx		Power terminals: KL8xxx		Safety terminals: KLx904		
Signal		Signal		Signal		
Position measurement	KL5001 KS5001 580 SSI encoder interface	KL5051 KS5051 580 bidirectional SSI encoder interface	400 V AC 3~	KL8001 592 switching capacity 5.5 kW, nominal current 0.9 to 9.9 A, connection mechanism for Siemens contactors (Sirius 3R series)	24 V DC	KL1904 531 TwinSAFE, 4-channel digital input terminal, IEC 61508 SIL 3 and DIN EN ISO 13849-1: 2008 PLc
	KL5101 KS5101 582 incremental encoder interface, differential input	KL5111 KS5111 583 incremental encoder interface		KL8601 593 communication module for Schneider TeSys U		KL2904 537 TwinSAFE, 4-channel digital output terminal, IEC 61508 SIL 3 and DIN EN ISO 13849-1: 2008 PLc
	KL5151 KS5151 583 incremental encoder interface, 32 bit	KL5152 KS5152 583 2-channel incremental encoder interface, 32 bit		KL8610 593 adapter terminal for Schneider TeSys U		KL6904 591 TwinSAFE Logic Bus Terminal, with 4 digital outputs, IEC 61508 SIL 3 and DIN EN ISO 13849-1: 2008 PLc
	KL5121 KS5121 581 incremental encoder interface with program. outputs	KL6001 KS6001 584 serial interface RS232, 19.2 kbaud		KL6031 KS6031 584 serial interface RS232, 115.2 kbaud		KL6011 KS6011 585 serial interface TTY, 20 mA current loop
Communication	KL6023 589 wireless adapter for EnOcean radio technology	KL6021-0023 588 RS485 interface for EnOcean signals	KL6581 588 EnOcean master	KL6583 588 EnOcean transmitter and receiver	KL6224 KS6224 589 IO-Link master	KM6551 587 wireless data exchange terminal
	KL6201 KS6201 586 AS-Interface master terminal	KL6211 KS6211 586 AS-Interface master terminal with power contacts	KL6301 KS6301 589 EIB Bus Terminal	KL6401 KS6401 590 LON Bus Terminal	KL6771 KS6771 590 MP-Bus master terminal	KL6811 KS6811 590 DALI/DSI master and power supply terminal

KLxxxx: Standard Bus Terminals, KSxxxx: Bus Terminals with pluggable wiring level

System terminals: KL9xxx KS9xxx				
Signal	System	Signal	Potential supply Power supply and accessories	
System	KL9010 598	24 V DC	KL9100 KS9100 594	
	bus end terminal		KL9400 KS9400 600	
	KL9020 598		input 24 V DC, K-bus power supply, 2 A	
	terminal bus extension end terminal		KL9110 KS9110 594	
	KL9050 598		diagnostic	KL9505 KS9505 600
	terminal bus extension coupler terminal		KL9200 595	input 24 V DC, output 5 V DC, 0.5 A
	KL9060 598		with fuse	KL9508 KS9508 601
	adapter terminal for power terminal KL8xxx		KL9210 595	input 24 V DC, output 8 V DC, 0.5 A
	KL9070 KS9070 595		diagnostic, with fuse	KL9510 KS9510 601
	shield terminal		KL9520 KS9520 602	input 24 V DC, output 10 V DC, 0.5 A
	KL9080 595		AS-Interface potential supply	KL9512 KS9512 601
	isolation terminal		KL9150 KS9150 594	input 24 V DC, output 12 V DC, 0.5 A
	KL9180 KS9180 596		KL9160 KS9160 594	KL9515 KS9515 601
	potential distribution terminal		diagnostic	input 24 V DC, output 15 V DC, 0.5 A
	KL9184 597		KL9250 595	with fuse
	potential distrib. terminal, 8 x 24 V DC, 8 x 0 V DC		KL9260 595	diagnostic, with fuse
	KL9185 KS9185 596		KL9190 KS9190 594	KL9290 595
	potential distrib. terminal, only 2 power contacts		with fuse	
	KL9186 KS9186 597			
	potential distribution terminal, 8 x 24 V			
KL9187 KS9187 597				
potential distribution terminal, 8 x 0 V				
KL9188 597				
potential distribution terminal, 16 x 24 V DC				
KL9189 597				
potential distribution terminal, 16 x 0 V DC				
KL9195 KS9195 595				
shield terminal				
Filter	KL9540 KS9540 603	50 V DC	KL9570 KS9570 604	
	surge filter terminal for field supply		buffer capacitor terminal, 500 µF, 50 V DC	
KL9550 KS9550 603				
surge filter terminal for system/field supply				
Diode array	KL9300 KS9300 599	120...230 V AC		
	4 diodes, potential-free	KL9150 KS9150 594		
	KL9301 KS9301 599	KL9160 KS9160 594		
	7 diodes, common cathode	diagnostic		
KL9302 KS9302 599	KL9250 595	with fuse		
7 diodes, common anode	KL9260 595	diagnostic, with fuse		
	up to 400 V AC			
	KL9190 KS9190 594			
	KL9290 595	with fuse		

Potential feeder terminals enable to set up different potential groups.

Bus Coupler:
the link between
Bus Terminals
and fieldbus

Bus Terminals in
1-, 2-, 4-, 8- and
16-channel modularity
with combinations
of any desired types
of signal

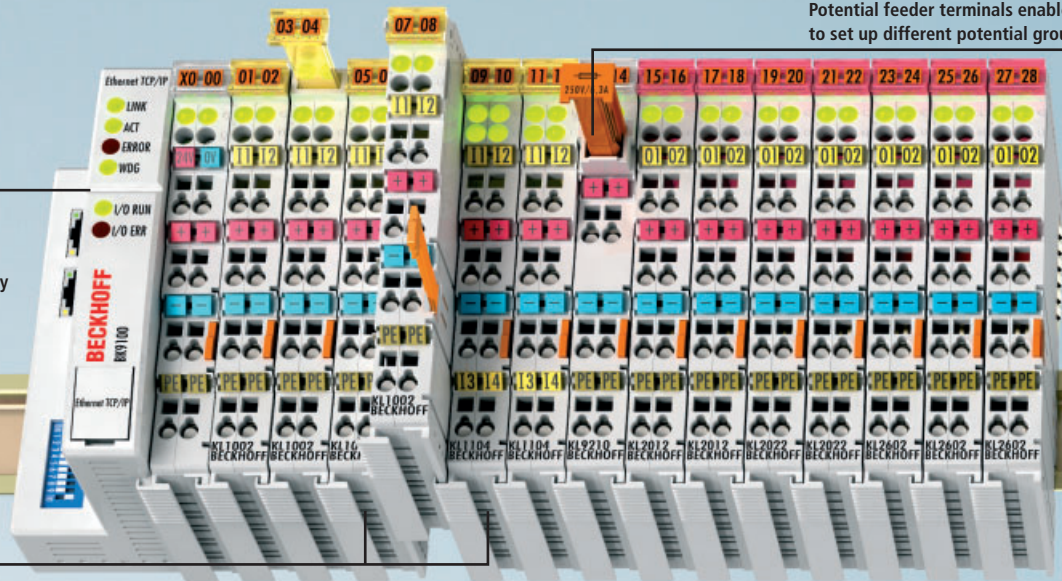

The Bus Terminal system

The I/O signals are wired in a decentralised way to fieldbus devices or centrally to the controller. The available manufacturer-specific fieldbus devices with fixed input/output configurations and design often make it necessary to use an entire group of devices with similar functions. This costly method of signal acquisition gives rise to high material, installation, planning and documentation costs as well as high costs for subsequent modification or expansion. Inventory management and service staff are put under unnecessary strain.

Flexible and stable

The Beckhoff Bus Terminal is an open and fieldbus-neutral I/O system consisting of electronic terminal blocks. The head of an electronic terminal block is the Bus Coupler with the interface to the fieldbus. Bus Couplers are available for the following bus systems:

- **EtherCAT**, the fast real-time Ethernet fieldbus,
- **Lightbus**, the fast fibre optic fieldbus,
- **PROFIBUS DP/FMS** conforms to the European standard EN 50170,
- **Interbus**, which has been on the market since 1987,
- **CANopen**, multi-masters in the actuator/sensor area,
- **DeviceNet**, the device bus with CAN technology,
- **ControlNet**, the standardised fieldbus,
- **Modbus**, the open fieldbus,

- **Fipio**, the fieldbus according to the WorldFIP standard,
- **CC-Link**, the fieldbus for the Asian market,
- **SERCOS interface**, the bus from the drives engineering field,
- **RS232/RS485**, the network for the most economical solution,
- **Ethernet TCP/IP**, the network bus,
- **Ethernet/IP**, Industrial Ethernet solution from ODVA,
- **PROFINET**, Industrial Ethernet solution from PNO,
- **USB**, the fast interface for the laboratory.

With the master terminals, fieldbus functionalities are also available in form of a standard Bus Terminal. This is particularly advantageous for bus systems that are integrated as subsystems into a higher-level system.

It means that only one system is required for the subsystem and for the higher-level bus interface. Master terminals are available for the following bus systems:

- **AS-Interface**, the sensor/actuator bus for the lower control level,
- **EIB, LON, DALI**, i.e. the communication standards in building automation.

Automation standard

The Beckhoff Bus Terminal ensures that control cabinets and terminal boxes are constructed more economically. Using the 4-wire terminating system, all of the usual sensors and actuators with different types of signals

can be connected directly without other connection systems. It is no longer necessary to wire the field devices between the first terminal connection in the control cabinet or in the terminal box and the controller. This significantly reduces the costs involved in controller design and saves space, material, work, and money.

The field devices can be wired using the Beckhoff Bus Terminal system on site where the signals occur. Installation and wiring of the Beckhoff Bus Terminal is thus simple like that of a standard terminal block. The Bus Terminal can be connected to the controller by connecting a Bus Coupler via the fieldbus as required.

The Beckhoff Bus Terminals have been tried and tested in a wide range of sectors worldwide, from machine construction to building management. Beckhoff Bus Terminal technology makes design, construction, wiring, commissioning and maintenance of equipment and machines very cost-effective.

Design

The robust housing, secure contacts and the solidly built electronics are prominent features of our components. A station consists of one Bus Coupler and up to 64 electronic terminal blocks. With the K-bus extension it is possible to operate up to 255 Bus Terminals on one Bus Coupler.

The electronic terminal blocks are clipped onto the Bus Coupler. They connect

Operation of up to 64 Bus Terminals on one Bus Coupler (255 with K-bus extension KL9020 and KL9050)

Fast and secure data connections by means of a serial terminal bus

Power contacts for automatic transfer of supply voltage



by simply latching together. This means that each electronic terminal block can be exchanged separately and can be mounted on a standard mounting rail. In addition to horizontal type mounting, all other mounting types are permitted in the majority of the cases.

The Beckhoff Bus Terminal with its outside contour adjusts perfectly to the measurements of terminal boxes. The clear front panel of the terminal with light-emitting diodes for status display, plug-in contact labelling and detachable labelling fields guarantee clarity. The 3-wire system supplemented by a protective conductor terminal makes it possible to wire sensors/actuators directly.

Free mix of signals

The Beckhoff I/O system supports about 400 Bus Terminals and is thus probably the most comprehensive system on the market. The components enable users to operate mixed signal configurations without restriction at each station. This means that a single non-central input/output node can map all the necessary signals.

Appropriate Bus Terminals are available for any digital or analog automation signal type, for currents and voltages with standardised signal levels and for PT100 and thermocouple signals. Intelligent devices can be connected via Bus Terminals with serial interfaces in accordance with RS232, RS485 or 20 mA TTY.

The fine granularity of the Bus Terminals enables bit-precise composition of the required I/O channels. The digital Bus Terminals are available as 2-, 4-, 8- or 16-channel terminals. In the 16-channel variant, digital input and output signals are arranged in an ultra-compact way within a standard Bus Terminal housing across a width of only 12 mm. The standard analog signals of -10...+10 V, 0...+10 V, 0...20 mA and 4...20 mA are all available as 1-, 2-, 4- and 8-channel variants within a standard housing. The system is thus highly modular and can be projected cost-effectively with an accuracy down to a single channel.

The KMxxxx terminal modules with plug-in wiring combine 16, 32 or 64 digital I/Os within a very small space and with high packing density.

Economical and small

For the user, Beckhoff Bus Terminals offer independence from the particular fieldbus and terminal block design. Digital and analog signals can be mixed without restriction, starting with one or two signals per terminal. They replace manufacturer-specific designs and all the intermediate terminal positions. The Bus Terminal ensures transparency and flexibility. Distributors and terminal boxes become smaller, more economical, and in some cases can be omitted. Plants and machinery equipped with Beckhoff Bus Terminals offer significant competitive advantages.

Project engineering and parameterisation

If the TwinCAT automation software from Beckhoff is used, the I/O stations can be integrated and parameterised conveniently via the TwinCAT System Manager. As a "configuration centre", the System Manager links the PLC programs and the connected I/O channels.

KLxxxx | The standard KL type Bus Terminals include electronics and connection level in a single housing.

The Bus Terminals with 16 terminal points offers a very high packing density in 12 mm.

KSxxxx | The KS series Bus Terminals feature a pluggable connection level enabling the complete wiring to be removed as a plug connector from the top of the housing for servicing.

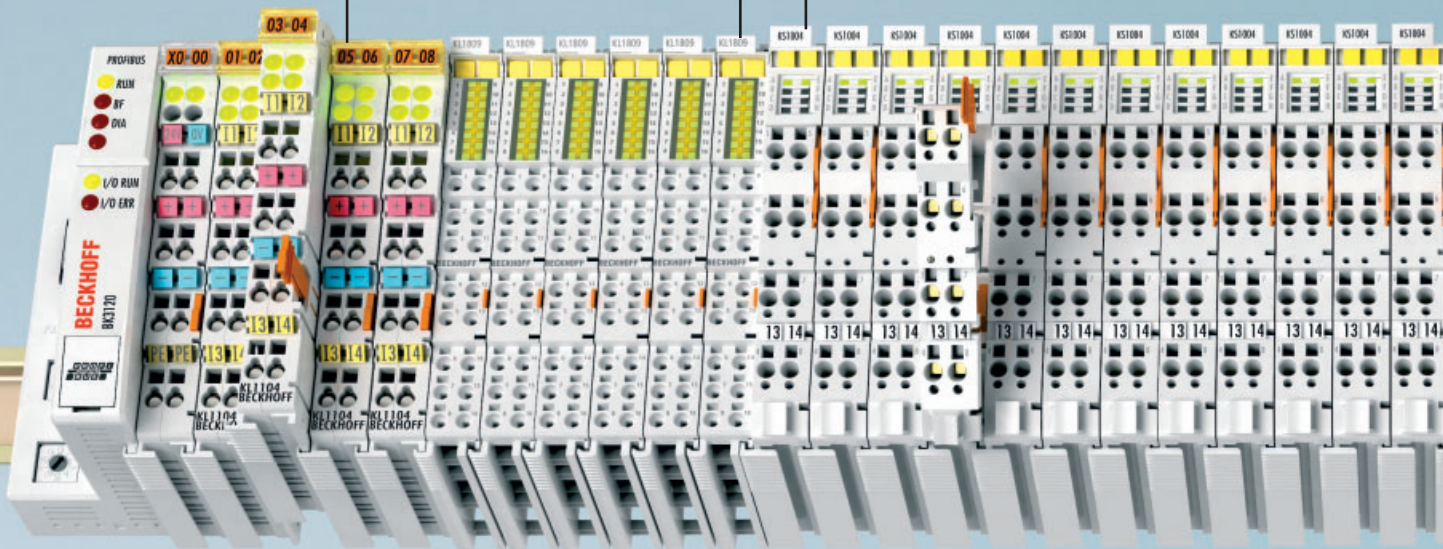

Flexible connection system

KLxxxx | Standard wiring

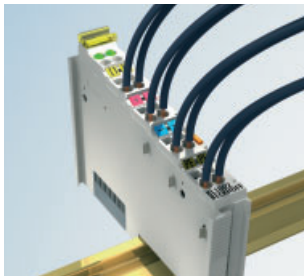

The Bus Terminal system offers different connection options for optimum adaptation to the respective application. The KLxxxx Bus Terminals include electronics and connection level in a single enclosure. The KSxxxx type Bus Terminals feature a pluggable connection level. The KM modules integrate a wide range of I/Os within a very small area. All terminal types are bus-neutral and can be combined as required.

The standard KL Bus Terminals have been tried and tested for years. They feature integrated screwless spring loaded technique for fast and simple assembly.



The HD Bus Terminals (High Density) with 16 terminal points are distinguished by a particularly compact design, as the packaging density is twice as large as that of the standard 12 mm Bus Terminals. Single-wire conductors and conductors with a wire end sleeve can be inserted directly into the spring loaded terminal point without tools.

KSxxxx | Pluggable wiring



The KS type Bus Terminals feature a pluggable connection level. The assembly and wiring procedure for the KS series is the same as for the KL series. The KS series Bus Terminals enable the complete wiring to be removed as a plug connector from the top of the housing for servicing. The lower section can be removed from the Bus Terminal assembly by pulling the unlocking tab. Insert the new component and plug in the connector with the wiring. This reduces the installation time and eliminates the risk of wires being mixed up.

The familiar dimensions of the Bus Terminal only had to be

changed slightly. The new connector adds about 3 mm. The maximum height of the Bus Terminal remains unchanged.

The overview and nomenclature of the product names has been retained: The plug connector variant is identified in the part number by an additional letter.

Conductor cross sections between 0.08 mm² and 2.5 mm² can continue to be used with the proven spring loaded technique.

A tab for strain relief of the cable simplifies assembly in many applications and prevents tangling of individual connection wires when the connector is removed.

KMxxxx | The KM type terminal modules feature pluggable wiring, combining 16, 32 or 64 digital I/Os in a very small area with high packing density.

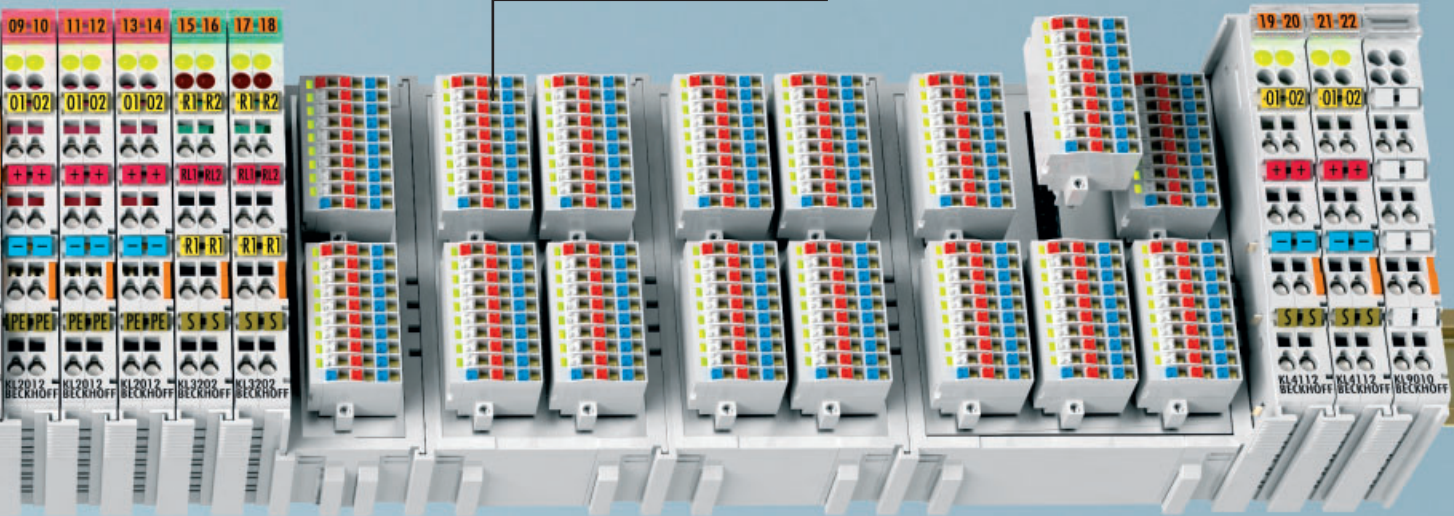

KMxxxx | Pluggable wiring with high packing density

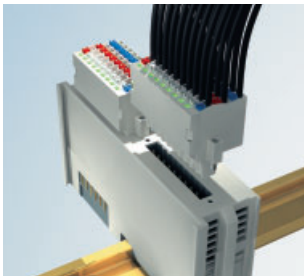

More sensor and actuator functionality makes machines and systems more and more powerful. The Bus Terminal reliably meets increased requirements for I/O signals through its modularity and compact design. The existing Bus Terminal system is complemented by the compact version of the KMxxxx terminal module with increased packing density. In many areas of application, cost benefits can be realised through lower overall installed size and application-specific signal mix.

The terminal modules are fully system-compatible. Like the Bus Terminals, they are bus-neu-

tral and can therefore be operated with any Beckhoff Bus Coupler or Bus Terminal Controller. Like the standard Bus Terminals, the KM modules are integrated in the I/O system and connected with the internal terminal bus (K-bus). Bus Terminals and terminal modules can be combined without restriction.

Like for the Bus Terminals, no tools are required for the wiring. Spring-loaded terminals are used, however with connectors (cable cross section 0.5...1.5 mm²).

The terminal modules combine 16, 32 or 64 digital inputs or outputs on a very small area. This compact and slimline design enables very high packing densities, leading to smaller control cabinets and terminal boxes.

Digital I/O modules with up to 64 channels

The KM modules are used, for example, in applications with high demand for standard signal

types such as digital I/Os. The very compact digital KM1xxx and KM2xxx input/output terminal modules have 16, 32 or 64 channels. Each I/O connector has eight inputs or outputs. LEDs integrated in the connector indicate the signal state for each channel directly at the wire. Depending on the connection type, the terminal modules are available with 1- or 3-pin plug connector and enable connection with 1, 2 or 3 wires.

Customer-specific signal mix

In addition to the standard I/O types, the terminal modules are also available as customer-specific types, e.g. for use in production machines with identical I/O combinations. The combination terminal modules consolidate typical automation signal combinations. This enables smaller physical size and quantity of parts with significant cost savings.

Interface standards within the Bus Terminal

In addition to plug-in wiring, sensor-specific plug connectors such as D-sub, RJ 45 or BNC simplify the application of the Bus Terminal system. Sensors and actuators with pre-assembled connectors can be connected directly and quickly with the Bus Terminal system.

Relay or power modules are also available, which are either equipped with standard relays or with integrated electronics to connect wattages up to 16 A.

Bus Terminal features

Status LEDs for reliable and fast startup

Marking material for standard terminal blocks

Supply point for downstream inputs and outputs

Detachable labelling fields for clear text labels

Power contacts connect the supply for sensors/actuators automatically.

Supply point for Bus Couplers and downstream inputs and outputs

Bus Couplers represent a universal interface to the fieldbuses.

Terminal block design
W x H x D (mm): 12 x 100 x 68

Assembly on 35 mm DIN mounting rail with no accessories

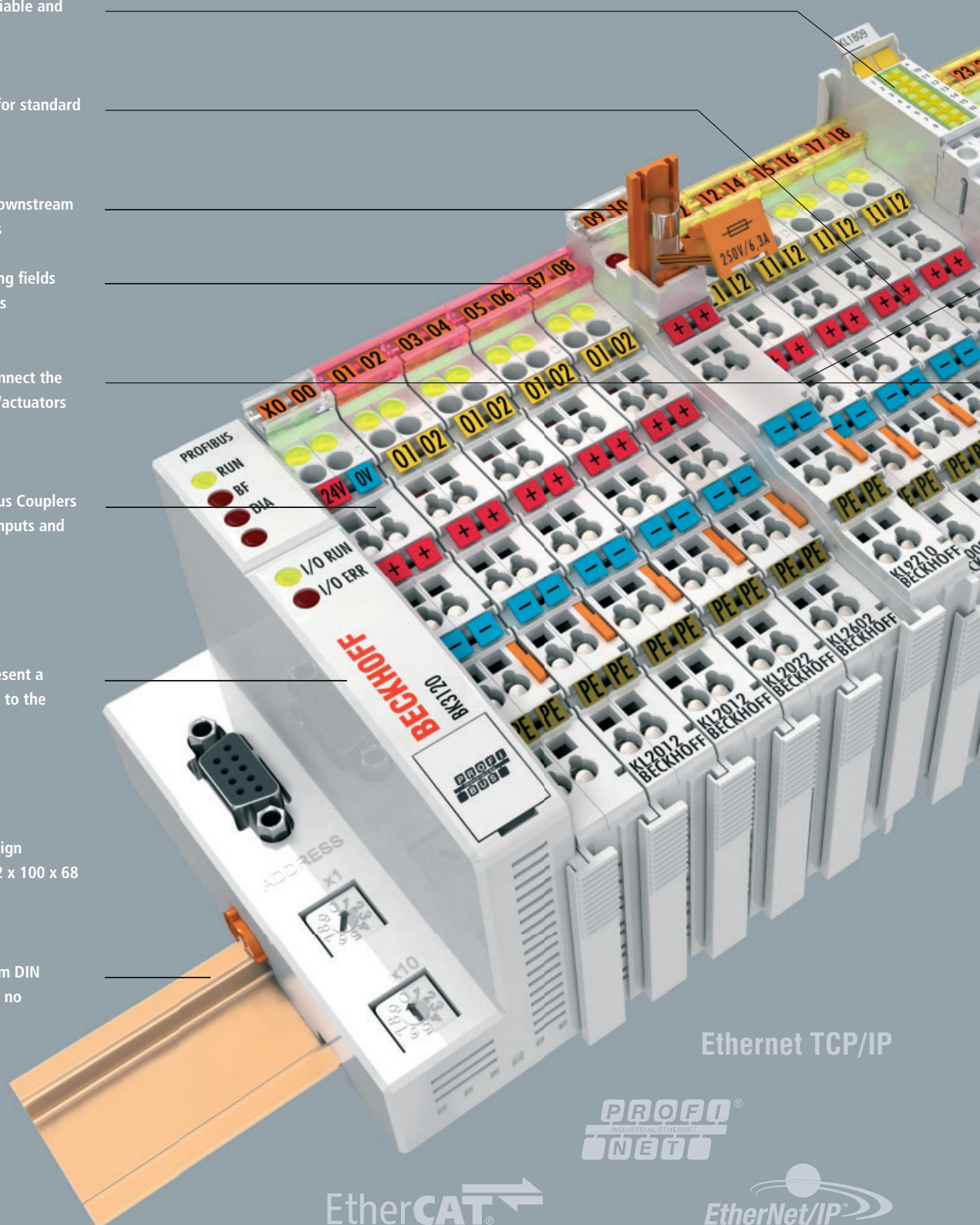

Ethernet TCP/IP



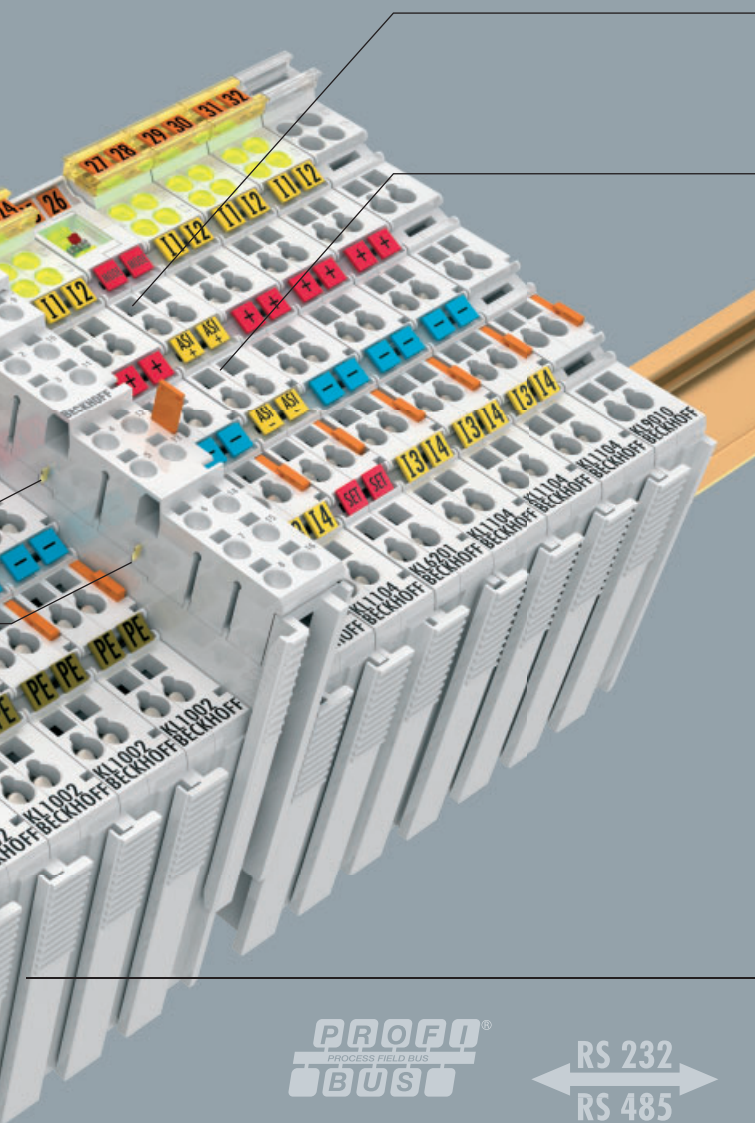

Screwless connection:
using the reliable spring-
loaded technique with
vertical cable inlet

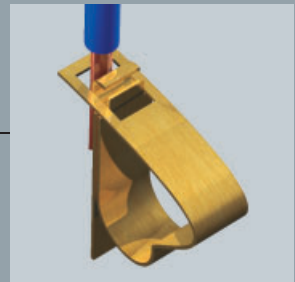

Master terminals enable
the integration of subsystems
such as AS-Interface.



Contacts for data trans-
mission and power supply
to the K-bus

Symmetric release enables
vertical removal from terminal
strip; release slide does not
require a tool.

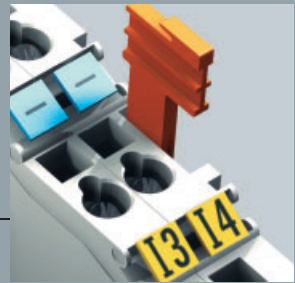

Tongue and groove
connection makes terminal
strip structure secure and
stable.



Leading PE power contact



The 4-wire terminating
system (signal, 24 V DC,
0 V, PE) reduces assembly
costs.

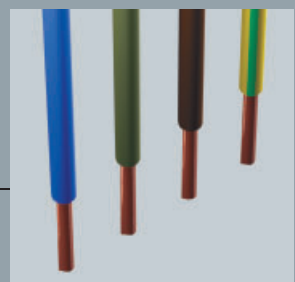

Beckhoff Bus Terminals: The complete automation kit



Bus Coupler series BK, the link between Bus Terminals and fieldbus



Bus Terminal Controller series BC with integrated IEC 61131-3 PLC



Bus Terminal Controller series BX with integrated IEC 61131-3 PLC and extended interfaces



Embedded PC series CX for PLC and Motion Control applications

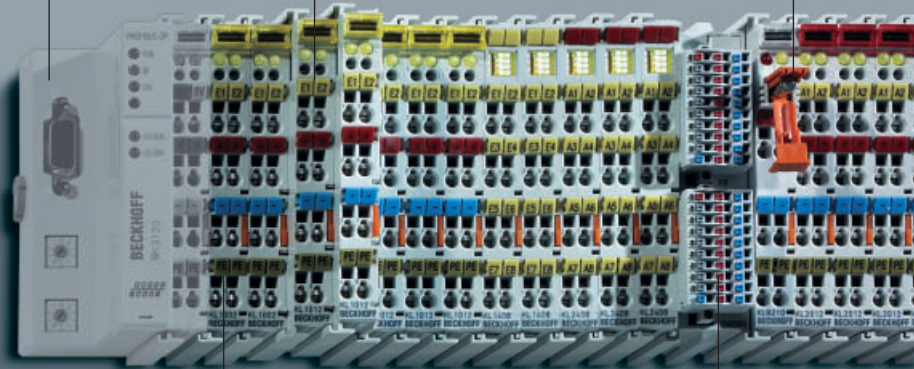

The head station of the Bus Terminals: from Bus Coupler with fieldbus interface to Embedded PC

Free mix of signals: about 400 different Bus Terminals for connection to all common sensors and actuators

Potential feed terminals enable configuration of different potential groups.

Bus Terminals in 1-, 2-, 4-, 8- and 16-channel modularity

The terminal modules with plug-in wiring combine 16, 32 or 64 digital I/Os within a very small space and with high packing density.

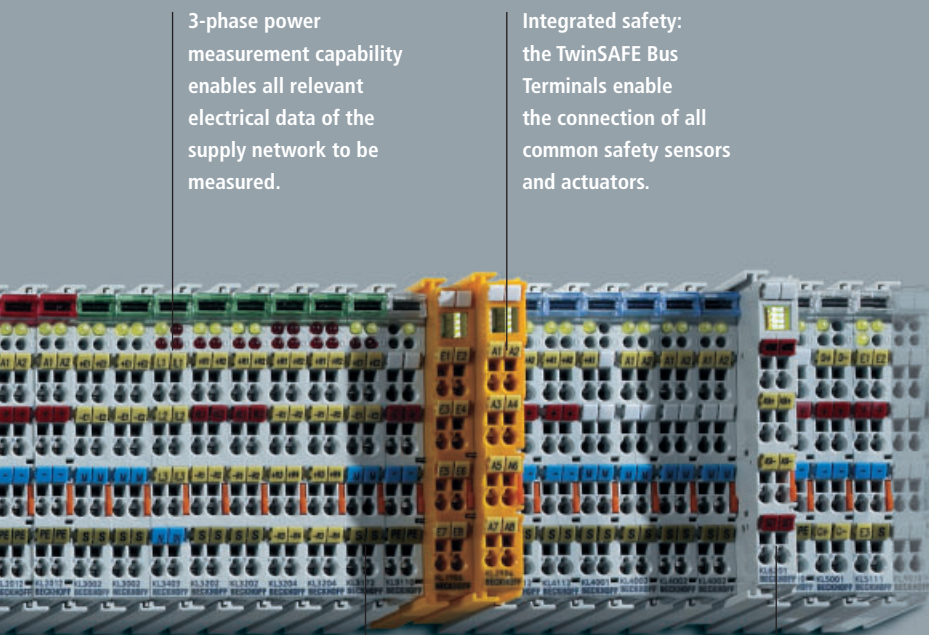

3-phase power measurement capability enables all relevant electrical data of the supply network to be measured.

Integrated safety: the TwinSAFE Bus Terminals enable the connection of all common safety sensors and actuators.

Bus Terminals with a maximum measurement error of $\pm 0.01\%$ expand the range of applications to high-precision measurement technology.

Communication terminals enable the integration of subsystems such as AS-Interface, RS232 and RS485.



Bus end terminal

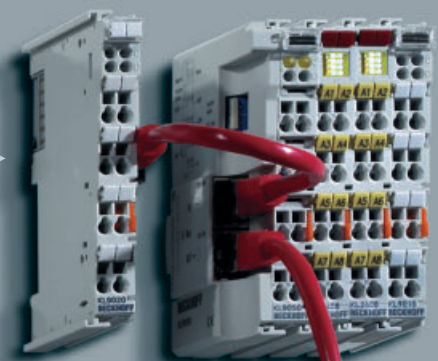

The terminal bus extension enables the connection of up to 255 Bus Terminals (instead of 64) to a single station.

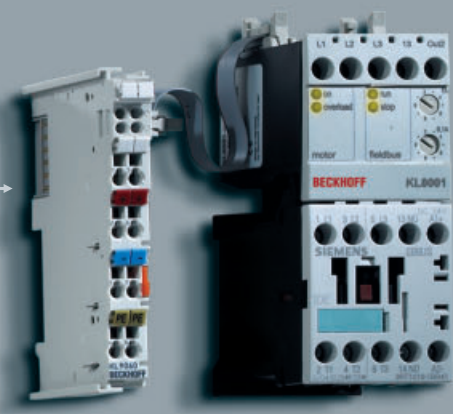

The power terminal transforms a standard contactor into a motor protection relay with comprehensive diagnostic functions.

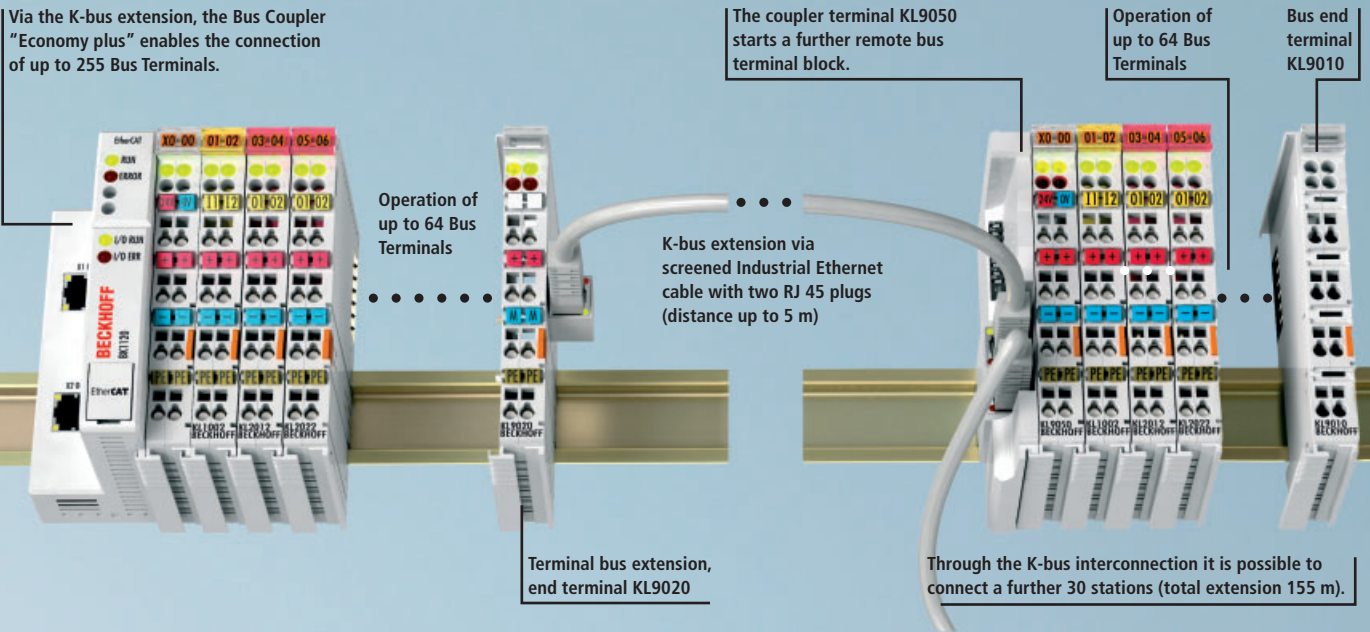

Terminal bus extension

The BKxxxx Bus Coupler links the bus systems to the modular, extendable electronic terminal blocks. One unit consists of one Bus Coupler, any number of terminals between 1 and 64, and a bus end terminal. The "Economy plus" and "Compact" series support all Bus Terminals of the Beckhoff system. It is also possible to operate up to 255 Bus Terminals on this Bus Coupler series with the K-bus extension.

The Bus Terminal extension allows Bus Terminals to be located in up to 31 blocks in the control cabinet or in the application. With a distance of up to 5 m between the Bus Terminal blocks, the Bus Terminal system can be used over a wider area and helps save costs.

The Bus Coupler recognises the terminals to which it is connected, and performs the assignment of the inputs and outputs to the

bytes of the process image automatically. The blocks with terminal bus extensions are treated as one unit by the Bus Coupler. The extension is transparent for the fieldbus and higher-level systems.

The system of Bus Coupler and Bus Terminal can be extended by replacing the end terminal KL9010 with the extension KL9020. The KL9020 makes available the K-bus signals in a RJ 45 socket for transmission onwards via a screened Industrial Ethernet cable.

The coupler terminal KL9050 starts a further remote Bus Terminal block and provides the logical connection to the Bus Coupler via the Ethernet cable. 24 V DC, electrically isolated, for the field level can be input at this coupler terminal. The internal K-bus shares the same potential as the K-bus of the coupler. The KL9050 can be used via

a second socket for the extension to the next Bus Terminal block. This Bus Terminal block starts in the same way as the one with a coupler terminal KL9050. This coupling works at up to 31 stations.

The maximum distance between two Bus Terminal blocks is 5 m and allows a total extension of 155 m. The system uses screened Industrial Ethernet cables with two RJ 45 plugs for the transmission. The cable is supplied ready-made in different lengths or can be made-to-measure for applications with conventional Ethernet tools.

Data transfer is based on the interference-free and RS485 industry standard in a double-screened cable.



Operation with up to 64 Bus Terminals to one Bus Coupler with KL9010 bus end terminal

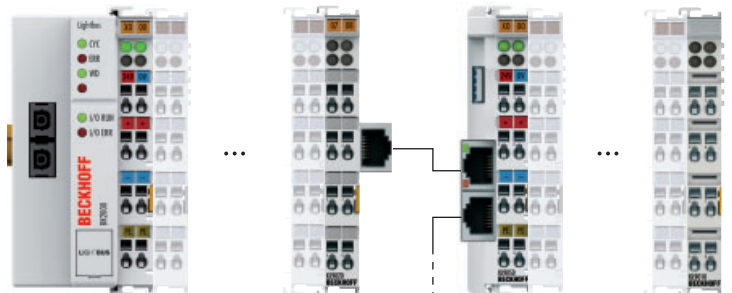

Operation with up to 255 Bus Terminals to one Bus Coupler with terminal bus extension end terminal KL9020 and coupler terminal KL9050

The TwinSAFE Bus Terminals enable the connection of all common safety sensors and actuators.

Certification: all TwinSAFE devices are subjected to a prototype test according to IEC 61508 and DIN EN ISO 13849-1:2008 PL.

The KL6904 TwinSAFE Logic Bus Terminal enables communication with up to 15 TwinSAFE devices. The Bus Terminal features certified safety blocks for functions such as emergency stop, safety door monitoring, etc. In addition, the TwinSAFE Logic Bus Terminal has four safe digital 24 V DC outputs.

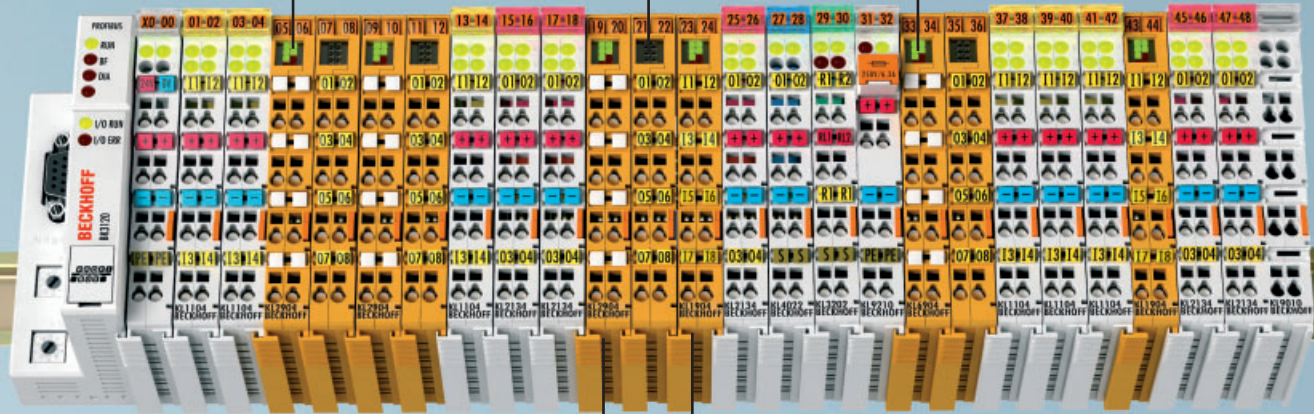

The KL2904 Safety Bus Terminal is a digital output terminal with four channels. The terminal switches 24 V DC actuators with up to 0.5 A total current.

The KL1904 digital input terminal for sensors with potential-free contacts for 24 V DC: the Safety Bus Terminal has 4 fail-safe inputs.

TwinSAFE | Safety and I/O technology in one system

TwinSAFE – the safety solution from Beckhoff – integrates safety functionalities into the existing control architecture. TwinSAFE from Beckhoff provides a consistent hardware and software technology for achieving integrated and simplified handling, ranging from safe input and output terminals and safe miniature controllers for the Bus Terminal system and the AX5000 Servo Drives to the PC-based Safety PLC.

The following TwinSAFE Bus Terminals are available:

- KL1904 | 4-channel digital input
- KL2904 | 4-channel digital output
- KL6904 | TwinSAFE Logic Bus Terminal with 4 digital outputs

For further information on TwinSAFE and the TwinSAFE products see page **828**

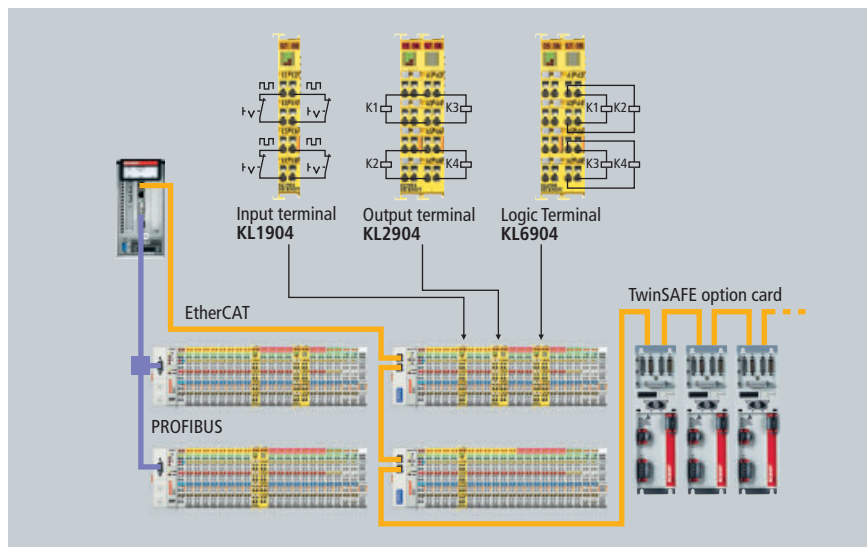

Open control technology for safety integration: the TwinSAFE protocol enables transfer of safety-relevant data via any medium.

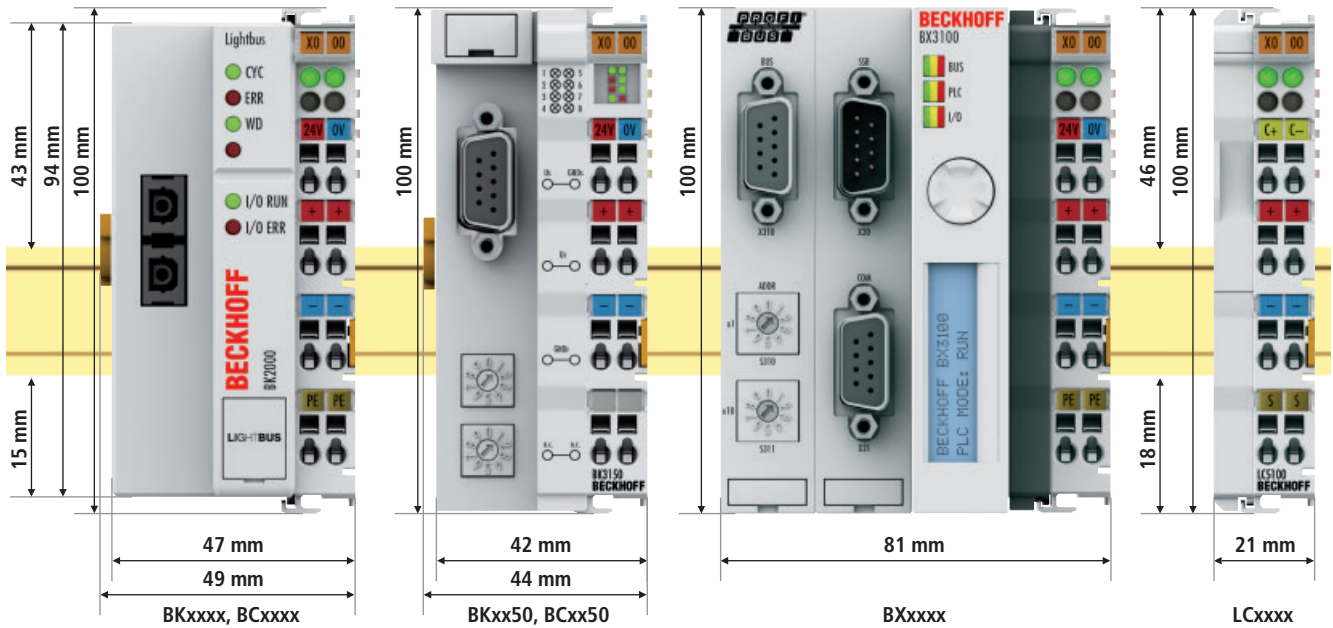

Technical data – Bus Coupler housing

The Beckhoff Bus Coupler electronics can be mounted in a variety of housings. A housing has three power contacts, which, if the application requires, automatically implement a continued connection, carrying the potential of the power circuit to the next Bus Terminal. The supply voltage that is connected to the Bus Coupler spring-loaded terminals is 24 V DC. If a different voltage is required for the power contacts, the appropriate power feed terminal must be inserted after the Bus Coupler.

Mechanical data	BKxxxx, BCxxxx	BKxx50, BCxx50	BXxxxx	LCxxxx
Design form	compact terminal housing with signal LED			
Material	polycarbonate			
Dimensions (W x H x D)	49 mm x 100 mm x 68 mm	44 mm x 100 mm x 68 mm	81 mm x 100 mm x 89 mm (BX8000: 61 mm x 100 mm x 89 mm)	21 mm x 100 mm x 68 mm
Installation	on 35 mm DIN rail, conforming to EN 50022 with lock			
Side by side mounting by means of	double slot and key connection			
Marking	standard terminal block marking			
Vibration/shock resistance	conforms to EN 60068-2-6/EN 60068-2-27/29			
EMC immunity/emission	conforms to EN 61000-6-2/EN 61000-6-4			

Connection	BKxxxx, BCxxxx	BKxx50, BCxx50	BXxxxx	LCxxxx
Wiring	spring-loaded technique			
Connection cross-section	0.08...2.5 mm ² , AWG 28-14, stranded wire, solid wire			
Stripping length	8...9 mm			
Fieldbus connection	depending on fieldbus	depending on fieldbus	depending on fieldbus	spring-loaded terminals
Power contacts	3 spring contacts			
Current load	I _{max} : 10 A (125 A short-circuit)			
Nominal voltage	24 V DC			



Technical data – Bus Terminal housing

The Beckhoff Bus Terminal electronics can be mounted in a variety of housings. Bus Terminals are available with up to three power contacts, and can have a variety of voltages. Care should be taken to ensure that a change in voltage always starts with a power feed terminal.

Mechanical data	KLxxxx	KL5101	KL5102	KSxxxx	KLx80x, KLx81x, KLx889	KL1862, KLx872
Design form	compact terminal housing with signal LED	compact terminal housing with signal LED	compact terminal housing with signal LED	terminal housing with pluggable wiring level	compact terminal housing with signal LED	compact terminal housing with signal LED
Material	polycarbonate					
Dimensions (W x H x D)	12 mm x 100 mm x 68 mm	24 mm x 100 mm x 68 mm	24 mm x 100 mm x 68 mm	12/24 mm x 100 mm x 71 mm	12 mm x 100 mm x 68 mm	12 mm x 100 mm x 68 mm
Installation	on 35 mm DIN rail, conforming to EN 50022 with lock					
Side by side mounting by means of	double slot and key connection					
Marking	standard terminal block marking	standard terminal block marking	standard terminal block marking	standard terminal block marking	–	standard terminal block marking
Vibration/shock resistance	conforms to EN 60068-2-6/EN 60068-2-27/29					
EMC immunity/emission	conforms to EN 61000-6-2/EN 61000-6-4					

Connection	KLxxxx	KL5101	KL5102	KSxxxx	KLx80x, KLx81x, KLx889	KL1862, KLx872
Wiring	spring-loaded technique	spring-loaded technique	spring-loaded technique	spring-loaded technique	direct plug-in technique	flat-ribbon cable connection
Connection cross-section	s, st*: 0.08... 2.5 mm ² , AWG 28-14	s, st*: 0.08... 2.5 mm ² , AWG 28-14	s, st*: 0.08... 2.5 mm ² , AWG 28-14	s, st*: 0.08... 1.5 mm ² , AWG 28-16	s*: 0.08...1.5 mm ² ; st: 0.25...1.5 mm ² ; f: 0.14...0.75 mm ²	common flat-ribbon cables, AWG 28, spacing 1.27 mm
Stripping length	8...9 mm	8...9 mm	8...9 mm	9...10 mm	8...9 mm	–
Power contacts	up to 3 blade/spring contacts	none	2 blade/spring contacts	2 blade/spring contacts	2 blade/spring contacts	none
Current load	I _{MAX} : 10 A (125 A short-circuit)					
Nominal voltage	depends on Bus Terminal type					

*s: solid wire; st: stranded wire; f: ferrule

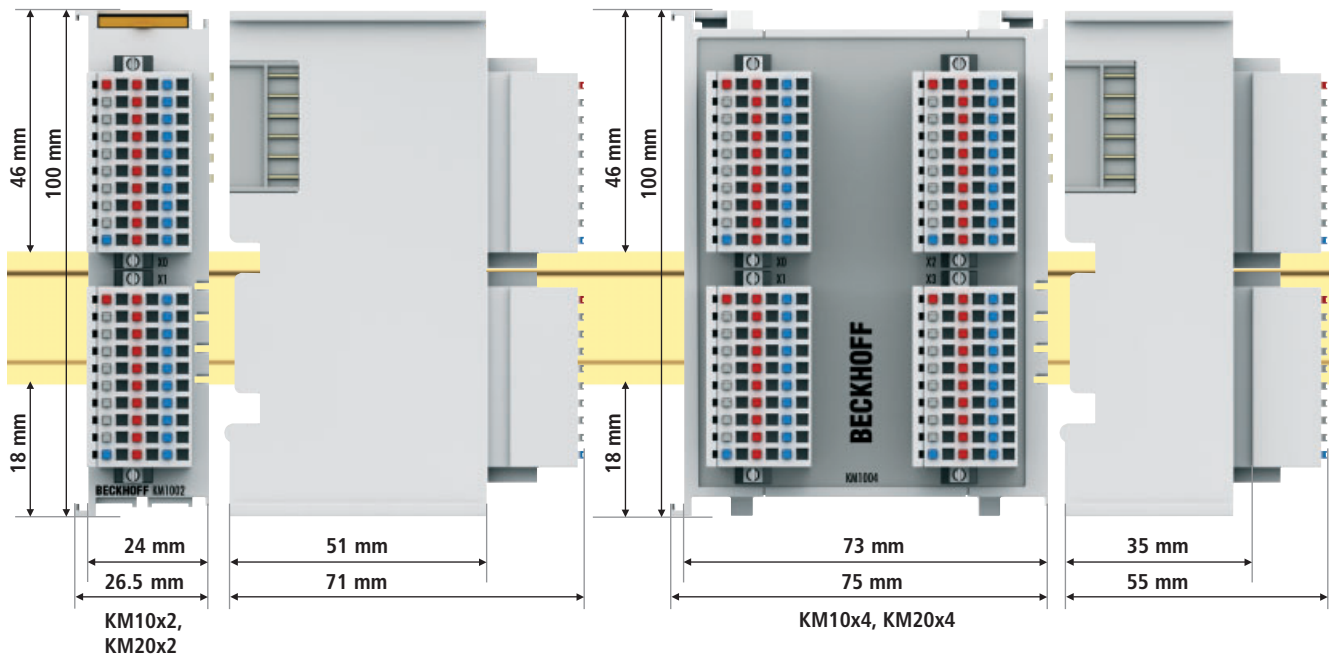

Technical data – Terminal module housing

The Beckhoff terminal modules with pluggable connection level are mounted in enclosures of different size. Like for the HD Bus Terminals, spring-loaded terminals are used and no tools are required for the wiring.

Mechanical data	KMx0x2	KMx0x4
Design form	compact terminal module with pluggable wiring level	
Dimensions (W x H x D)	26.5 mm x 100 mm x 71 mm	75 mm x 100 mm x 55 mm
Installation	on 35 mm DIN rail, conforming to EN 50022 with lock	
Side by side mounting by means of	double slot and key connection	
Vibration/shock resistance	conforms to EN 60068-2-6/EN 60068-2-27/29	
EMC immunity/emission	conforms to EN 61000-6-2/EN 61000-6-4	
Connection	KMx0x2, KMx0x4	
Wiring	spring-loaded technique	
Connection cross-section	0.08...1.5 mm ² , stranded wire, solid wire	
Stripping length	8 mm	
Power contacts	none	
Nominal voltage	depends on Bus Terminal type, max. 60 V DC	

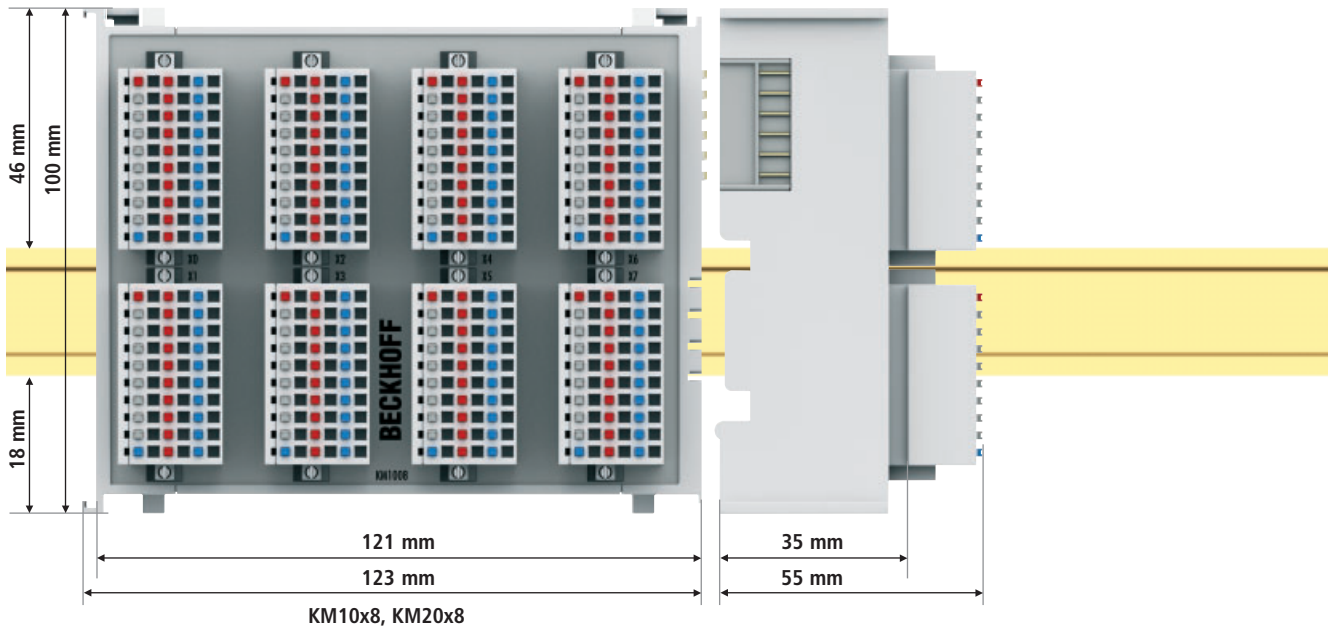

Mechanical data	KMx0x8
Design form	compact terminal module with pluggable wiring level
Dimensions (W x H x D)	123 mm x 100 mm x 55 mm
Installation	on 35 mm DIN rail, conforming to EN 50022 with lock
Side by side mounting by means of	double slot and key connection
Vibration/shock resistance	conforms to EN 60068-2-6/EN 60068-2-27/29
EMC immunity/emission	conforms to EN 61000-6-2/EN 61000-6-4

Connection	KMx0x8
Wiring	spring-loaded technique
Connection cross-section	0.08...1.5 mm ² , stranded wire, solid wire
Stripping length	8 mm
Power contacts	none
Nominal voltage	depends on Bus Terminal type, max. 60 V DC

BKxxxx | Bus Couplers

The interface between fieldbus and terminals

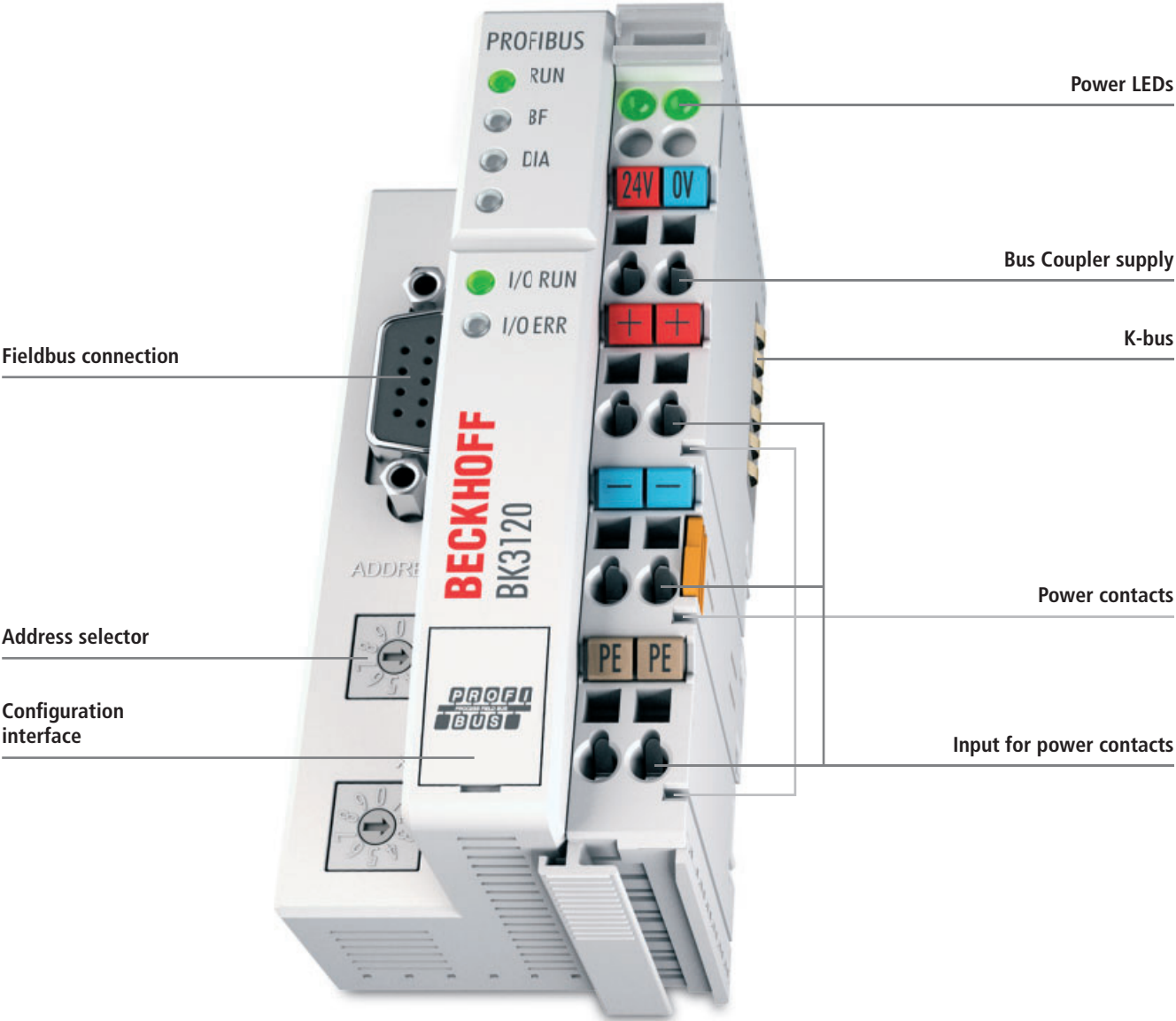

Bus Terminal
490

Fieldbus connection

Address selector

Configuration interface

Power LEDs

Bus Coupler supply

K-bus

Power contacts

Input for power contacts

For further information on the individual fieldbuses see page 242



Standard | BKxx00



Economy | BKxx10



Economy plus | BKxx20



Compact | BKxx50



Low Cost | LCxx00

The Bus Couplers link the modularly expandable electronic terminal blocks with the respective fieldbus systems. The Bus Coupler performs all the monitoring and control tasks that are necessary for operation of the connected Bus Terminals.

The specific settings of analog and multifunctional Bus Terminals are adapted to the application via the KS2000 configuration software.

In the standard Bus Couplers a unit consists of a Bus Coupler, any number of up to 64 terminals and a bus end terminal.

The "Economy" versions enable particularly cost-effective configuration of peripheral interfacing connections with up to 64 digital input/output terminals.

In addition to digital signal types, the "Economy plus" Bus Couplers also support all other types. Up to 255 Bus Terminals can be connected via the K-bus extension.

The "Compact" Bus Couplers have a particularly compact housing and also enable connection of up to 255 Bus Terminals via the terminal bus extension.

The "Low Cost" Bus Couplers are characterised by small dimensions and cost-effective connection technology and enable connection of up to 64 digital input/output terminals.



The Bus Terminal system has stood the test of time in machine or building automation applications where a temperature range of 0 to 55 °C is sufficient. For requirements beyond that, the operating temperature range of selected standard Bus Terminals and Couplers has been extended to -20 to +60 °C. The storage temperature of these ET components (Extended Temperature Range) has also been adapted and is now -40 to +85 °C. The exact definition of the operating conditions in temperature ranges outside 0 to 55 °C, installation requirements that possibly deviate from the standard and, if applicable, deviating technical data can be found in the documentation. Bus Couplers that have been qualified for the extended temperature range are identified accordingly.

Technical data	BKxxxx, LCxxxx
Power supply	24 V DC (-15 %/+20 %)
Operating/storage temperature	0...+55 °C/-25...+85 °C (extended temperature range: -20...+60 °C/-40...+85 °C)
Relative humidity	95 %, no condensation
Vibration/shock resistance	conforms to EN 60068-2-6/EN 60068-2-27/29
EMC immunity/emission	conforms to EN 61000-6-2/EN 61000-6-4
Protect. class/installation pos.	IP 20/variable

EtherCAT | Bus Coupler



The EtherCAT BK1120 “Economy plus” Bus Coupler is used for connection of different Bus Terminals to the EtherCAT fieldbus system. EtherCAT enables the Ethernet star topology to be replaced with a simple line structure. The upper Ethernet interface of the BK1120 is the network connection. The lower RJ 45 socket can be used for connecting further EtherCAT devices to the same strand.

The BK1250 “Compact” Coupler enables mixed application of EtherCAT Terminals (ELxxxx) and standard Bus Terminals (KLxxxx) in a bus station. The “Bus Coupler in terminal housing” integrates the Bus Terminals directly into the EtherCAT terminal strand, thereby enabling compact control solutions. The wide range of Bus Terminal products can thus be optimally combined with the communication speed and the large choice of EtherCAT Terminals.



The EtherCAT Terminals are connected via suitable EtherCAT couplers of EKxxxx type (see page 316).

EtherCAT “Economy plus” Bus Coupler for up to 64 Bus Terminals (255 with K-bus extension)	“Compact” coupler between E-bus and K-bus Terminals
--	---

Technical data	BK1120	BK1250
Number of Bus Terminals	64 (255 with K-bus extension)	
Max. number of bytes fieldbus	1,024 byte input and 1,024 byte output	
Current supply K-bus	1,750 mA	500 mA
	<p>The BK1120 Bus Coupler connects EtherCAT, the real-time Ethernet system, with the modular, extendable electronic terminal blocks. A unit consists of a Bus Coupler, any number (between 1 and 64) of terminals (255 with K-bus extension) and one end terminal.</p>	<p>The BK1250 is a “Bus Coupler in terminal housing” for mixed application of EtherCAT Terminals (ELxxxx) and standard Bus Terminals (KLxxxx) in a bus station. Up to 64 Bus Terminals (with K-bus extension up to 255) can be connected to a BK1250.</p>
Bus interface	2 x RJ 45	E-bus contacts on the left/ K-bus contacts on the right
Data transfer rates	100 Mbaud	100 Mbaud
Weight	approx. 150 g	approx. 55 g
Operating temperature	-20...+60 °C	0...+55 °C
Approvals	CE, UL, Ex	CE, UL, Ex
Further information	www.beckhoff.com/BK1120	www.beckhoff.com/BK1250
Accessories		
Cordsets and connectors	see page 608	see page 608
PC Fieldbus Cards	FC90xx 706	FC90xx 706

Lightbus | Bus Coupler

LIGHTBUS

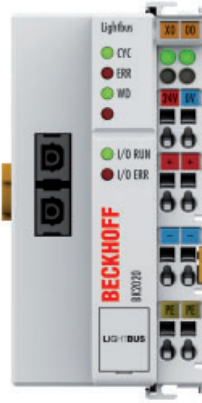
	Lightbus Bus Coupler for up to 64 Bus Terminals	Lightbus Bus Coupler for up to 64 digital Bus Terminals	Lightbus "Economy plus" Bus Coupler for up to 64 Bus Terminals (255 with K-bus extension)
Technical data	BK2000	BK2010	BK2020
Number of Bus Terminals	64		64 (255 with K-bus extension)
Max. number of bytes fieldbus	512 byte input and 512 byte output	32 byte input and 32 byte output	512 byte input and 512 byte output
Current supply K-bus	1,750 mA	500 mA	1,750 mA
	 <p>The BK2000 Bus Coupler connects the Lightbus system to the electronic terminal blocks, which can be expanded in modular fashion. One unit consists of one Bus Coupler, any number of up to 64 terminals and one end terminal.</p> <ul style="list-style-type: none"> – distance between stations: 45 m for APF fibre, 300 m HCS fibre 	 <p>The BK2010 „Economy“ variant permits particularly economical creation of peripheral interfacing connections. Up to 64 digital input/output terminals can be connected.</p> <ul style="list-style-type: none"> – distance between stations: 45 m for APF fibre, 300 m HCS fibre 	 <p>With the K-bus extension technology, the "Economy plus" Bus Coupler BK2020 allows the connection of up to 255 spatially distributed Bus Terminals to one Bus Coupler. The "Economy plus" series supports all Beckhoff system Bus Terminals. It can process in its full configuration 1,020 digital signals and a maximum of 128 analog input and output channels per slave.</p> <ul style="list-style-type: none"> – distance between stations: 45 m for APF fibre, 300 m HCS fibre
Bus interface	2 x standard fibre optic connector Z1000 (plastic fibre), Z1010 (HCS fibre)	2 x standard fibre optic connector Z1000 (plastic fibre), Z1010 (HCS fibre)	2 x standard fibre optic connector Z1000 (plastic fibre), Z1010 (HCS fibre)
Data transfer rates	2.5 Mbaud	2.5 Mbaud	2.5 Mbaud
Weight	approx. 150 g	approx. 130 g	approx. 150 g
Operating temperature	0...+55 °C	0...+55 °C	0...+55 °C
Approvals	CE, UL, Ex	CE, UL, Ex	CE, UL, Ex
Further information	www.beckhoff.com/BK2000	www.beckhoff.com/BK2010	www.beckhoff.com/BK2020
Accessories			
Cordsets and connectors	see page 608	see page 608	see page 608
PC Fieldbus Cards	FC200x 701	FC200x 701	FC200x 701



PROFIBUS | Bus Coupler







PROFIBUS Bus Coupler
for up to 64 digital Bus Terminals,
1.5 Mbaud

PROFIBUS DP/FMS Bus Coupler
for up to 64 Bus Terminals,
12 Mbaud



PROFIBUS Bus Coupler
for up to 64 digital Bus Terminals,
12 Mbaud

Technical data	BK3010	BK3100	BK3110
Number of Bus Terminals	64		
Max. number of bytes fieldbus	64 byte input and 64 byte output	64 byte input and 64 byte output (DP and FMS mode), 128 byte input and 128 byte output (only DP mode)	64 byte input and 64 byte output
Current supply K-bus	500 mA	1,750 mA	500 mA
	 <p>The BK3010 „Economy“ variant permits particularly economical creation of peripheral interfacing connections. Up to 64 digital input/output terminals can be connected.</p>	 <p>The BK3100 Bus Coupler connects the PROFIBUS system to the electronic terminal blocks, which can be extended in modular fashion. One unit consists of the Bus Coupler, any number of up to 64 terminals and one end terminal.</p>	 <p>The BK3110 „Economy“ variant permits particularly economical creation of peripheral interfacing connections. Up to 64 digital input/output terminals can be connected.</p>
Bus interface	1 x D-sub 9-pin socket with shielding	1 x D-sub 9-pin socket with shielding	1 x D-sub 9-pin socket with shielding
Data transfer rates	automatic detection up to max. 1.5 Mbaud	12 Mbaud	12 Mbaud
Weight	approx. 150 g	approx. 170 g	approx. 150 g
Operating temperature	0...+55 °C	0...+55 °C	0...+55 °C
Approvals	CE, UL, Ex, GL	CE, UL, Ex, GL	CE, UL, Ex, GL
Further information	www.beckhoff.com/BK3010	www.beckhoff.com/BK3100	www.beckhoff.com/BK3110
Accessories			
Cordssets and connectors	see page 608	see page 608	see page 608
PC Fieldbus Cards	FC310x 702	FC310x 702	FC310x 702



	PROFIBUS "Economy plus" Bus Coupler for up to 64 Bus Terminals (255 with K-bus extension), 12 Mbaud	PROFIBUS "Compact" Bus Coupler for up to 64 Bus Terminals (255 with K-bus extension), 12 Mbaud	PROFIBUS Bus Coupler with fibre optic connection for up to 64 Bus Terminals, 1.5 Mbaud	PROFIBUS "Economy plus" Bus Coupler for up to 64 Bus Terminals (255 with K-bus extension), 12 Mbaud	PROFIBUS "Low Cost" Bus Coupler for up to 64 digital Bus Terminals, 12 Mbaud
	BK3120	BK3150	BK3500	BK3520	LC3100
	64 (255 with K-bus extension)		64	64 (255 with K-bus extension)	64
	128 byte input and 128 byte output				64 byte input and 64 byte output
	1,750 mA	1,000 mA	1,750 mA	1,750 mA	500 mA
					
	The "Economy plus" version extends the existing PROFIBUS Bus Coupler series BK3xx0. The K-bus extension technology allows the connection of up to 255 spatially distributed Bus Terminals to one Bus Coupler.	The "Compact" Bus Coupler BK3150 for PROFIBUS extends the Beckhoff Bus Terminal system by a cost-optimised version in a compact housing.	The particular feature of the BK3500 Bus Coupler is its fibre optic connection. The fibre optics mean that the transmission is particu- larly safe from interference and has absolute electrical isolation. – distance between stations: up to 25 m	The particular feature for the BK3520 Bus Coupler is its fibre optic connection and its high transmission rate of up to 12 Mbaud. – distance between stations: up to 40 m	The LC3100 "Low Cost" Bus Coupler is marked by a smaller design and a more economical connec- tion method.
	1 x D-sub 9-pin socket with shielding	1 x D-sub 9-pin socket with shielding	2 x HP-Simplex sockets (HP-Simplex plugs included)	4 x HP-Simplex sockets (HP-Simplex plugs ZS1031- 3500 included)	connection via Bus Terminal
	automatic detection up to 12 Mbaud	automatic detection up to 12 Mbaud	automatic detection up to max. 1.5 Mbaud	automatic detection up to 12 Mbaud	up to 12 Mbaud
	approx. 170 g	approx. 100 g	approx. 170 g	approx. 170 g	approx. 100 g
	-20...+60 °C	-20...+60 °C	0...+55 °C	0...+55 °C	0...+55 °C
	CE, UL, Ex, GL	CE, UL, Ex	CE, UL, Ex	CE, UL, Ex	CE, UL, Ex
	www.beckhoff.com/BK3120	www.beckhoff.com/BK3150	www.beckhoff.com/BK3500	www.beckhoff.com/BK3520	www.beckhoff.com/LC3100
	see page 608	see page 608	see page 608	see page 608	see page 608
	FC310x 702	FC310x 702	FC310x 702	FC310x 702	FC310x 702

Interbus, CANopen | Bus Coupler



	Interbus Bus Coupler for up to 64 Bus Terminals	Interbus Bus Coupler for up to 64 digital Bus Terminals	Interbus "Economy plus" Bus Coupler for up to 64 Bus Terminals (255 with K-bus extension)
Technical data	BK4000	BK4010	BK4020
Number of Bus Terminals	64		64 (255 with K-bus extension)
Max. number of bytes fieldbus	64 byte input and 64 byte output	8 byte input and 8 bytes output	64 byte input and 64 byte output
Current supply K-bus	1,750 mA	500 mA	1,750 mA
	 <p>The BK4000 Bus Coupler connects the Interbus bus system to the electronic terminal blocks, which can be extended in modular fashion. One unit consists of one Bus Coupler, any number of up to 64 terminals and one end terminal.</p>	 <p>The BK4010 „Economy“ variant permits particularly economical creation of peripheral interfacing connections. Up to 64 digital input/output terminals can be connected.</p>	 <p>With the K-bus extension technology, the "Economy plus" Bus Coupler BK4020 allows the connection of up to 255 spatially distributed Bus Terminals to one Bus Coupler. The "Economy plus" coupler supports all Beckhoff system Bus Terminals and can process 512 bit digital inputs and outputs per slave.</p>
Bus interface	2 x D-sub plug, 9-pin, plug and socket with screening and vibration lock	2 x D-sub plug, 9-pin, plug and socket with screening and vibration lock	2 x D-sub plug, 9-pin, plug and socket with screening and vibration lock
Data transfer rates	500 kbaud	500 kbaud	500 kbaud
Weight	approx. 170 g	approx. 150 g	approx. 170 g
Operating temperature	0...+55 °C	0...+55 °C	0...+55 °C
Approvals	CE, UL, Ex	CE, UL, Ex	CE, UL, Ex
Further information	www.beckhoff.com/BK4000	www.beckhoff.com/BK4010	www.beckhoff.com/BK4020
Accessories			
Cordssets and connectors	see page 608	see page 608	see page 608
PC Fieldbus Cards	–	–	–

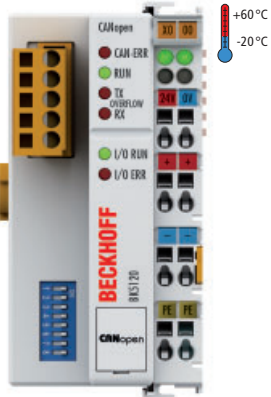
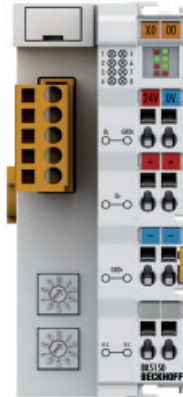

CANopen



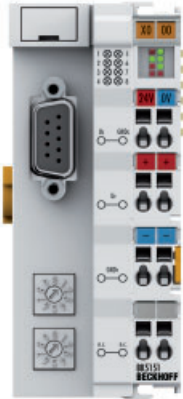

	Interbus Bus Coupler with fibre optic connection for up to 64 Bus Terminals	CANopen Bus Coupler for up to 64 digital Bus Terminals	CANopen "Economy plus" Bus Coupler for up to 64 Bus Terminals (255 with K-bus extension)	CANopen "Compact" Bus Coupler for up to 64 Bus Terminals (255 with K-bus extension)
	BK4500	BK5110	BK5120	BK5150
	64	64	64 (255 with K-bus extension)	
		5 Tx/Rx PDOs	16 Tx/Rx PDOs	
	1,750 mA	500 mA	1,750 mA	1,000 mA
	 <p>The particular feature for the BK4500 Bus Coupler is its fibre optic connection. Its functions correspond to those of the BK4000 Bus Coupler in relation to the Bus Terminals and the fieldbus properties. The fibre optics mean that the transmission is particularly safe from interference, and has absolute electrical isolation.</p>	 <p>The BK5110 "Economy" variant permits particularly economical creation of peripheral interfacing connections. Up to 64 digital input/output terminals can be connected.</p>	 <p>With the K-bus extension technology, the "Economy plus" Bus Coupler BK5120 allows the connection of up to 255 spatially distributed Bus Terminals to one Bus Coupler. The Bus Coupler works on the CAN protocol basis as defined in ISO 11898.</p>	 <p>The "Compact" Bus Coupler BK5150 for CANopen extends the Beckhoff Bus Terminal system by a cost-optimised version in a compact housing. Up to 64 Bus Terminals are supported; with the terminal bus extension, up to 255 Bus Terminals can be connected. The CANopen Bus Coupler offers automatic baud rate detection up to 1 Mbaud and two address selection switches for address assignment.</p>
	2 x 2 FSMA plugs	1 x open style connector, 5-pin, included	1 x open style connector, 5-pin, included	open style connector, 5-pin
	500 kbaud	up to 1 Mbaud	up to 1 Mbaud	automatic detection up to 1 Mbaud
	approx. 170 g	approx. 130 g	approx. 150 g	approx. 100 g
	0...+55 °C	0...+55 °C	-20...+60 °C	0...+55 °C
	CE, UL, Ex	CE, UL, Ex, GL	CE, UL, Ex, GL	CE, UL, Ex
	www.beckhoff.com/BK4500	www.beckhoff.com/BK5110	www.beckhoff.com/BK5120	www.beckhoff.com/BK5150
	see page 608	see page 608	see page 608	see page 608
	–	FC510x 703	FC510x 703	FC510x 703

CANopen, DeviceNet | Bus Coupler

CANopen

DeviceNet™

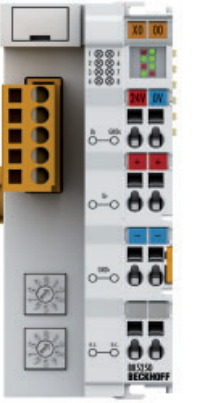
	CANopen "Compact" Bus Coupler for up to 64 Bus Terminals (255 with K-bus extension)	CANopen "Low Cost" Bus Coupler for up to 64 digital Bus Terminals (255 with K-bus extension)	DeviceNet Bus Coupler for up to 64 Bus Terminals
Technical data	BK5151	LC5100	BK5200
Number of Bus Terminals	64 (255 with K-bus extension)	64 byte input and 64 byte output	64
Max. number of bytes fieldbus	16 Tx/Rx PDOs	5 Tx/Rx PDOs	512 byte input and 512 byte output
Current supply K-bus	1,000 mA	500 mA	1,750 mA
	 <p>In contrast to the BK5150, the BK5151 has a 9-pin D-sub connector as a bus interface.</p>	 <p>The LC5100 "Low Cost" Bus Coupler is marked by a smaller design and a more economical connection method. All the bit-oriented terminals can be connected to the LC5100. All the digital input and output terminals are supported with the exception of the KL15xx, KL25x2, KL2692 and KL27x1 terminals. All the system terminals, with and without diagnostics, can also be connected.</p>	 <p>The BK5200 Bus Coupler connects the DeviceNet bus system to the electronic terminal blocks, which can be extended in modular fashion. One unit consists of one Bus Coupler, any number of up to 64 terminals and one end terminal.</p>
Bus interface	D-sub 9-pin socket	connection via Bus Terminal	1 x open pluggable connector, 5-pin, included
Data transfer rates	automatic detection up to 1 Mbaud	up to 1 Mbaud	automatic detection up to 500 kbaud
Weight	approx. 100 g	approx. 100 g	approx. 150 g
Operating temperature	0...+55 °C	0...+55 °C	0...+55 °C
Approvals	CE, UL, Ex	CE, UL, Ex	CE, UL, Ex
Further information	www.beckhoff.com/BK5151	www.beckhoff.com/LC5100	www.beckhoff.com/BK5200
Accessories			
Cordsets and connectors	see page 608	see page 608	see page 608
PC Fieldbus Cards	FC510x 703	FC510x 703	FC520x 704

DeviceNet Bus Coupler for up to 64 digital Bus Terminals	DeviceNet "Economy plus" Bus Coupler for up to 64 Bus Terminals (255 with K-bus extension)	DeviceNet "Compact" Bus Coupler for up to 64 Bus Terminals (255 with K-bus extension)	DeviceNet "Low Cost" Bus Coupler for up to 64 digital Bus Terminals (255 with K-bus extension)
BK5210	BK5220	BK5250	LC5200
	64 (255 with K-bus extension)		64
32 byte input and 32 byte output	512 byte input and 512 byte output		32 byte input and 32 byte output
500 mA	1,750 mA	1,000 mA	500 mA
 <p>The BK5210 "Economy" variant permits particularly economical creation of peripheral interfacing connections. Up to 64 digital input/output terminals can be connected.</p>	 <p>With the K-bus extension technology, the "Economy plus" Bus Coupler BK5220 allows the connection of up to 255 spatially distributed Bus Terminals to one Bus Coupler. The "Economy plus" series supports all Beckhoff system Bus Terminals and it can process in its full configuration 1,020 digital signals and a maximum of 256 analog input and output channels per slave.</p>	 <p>The "Compact" Bus Coupler BK5250 for DeviceNet extends the Beckhoff Bus Terminal system by a cost-optimised version in a compact housing. The DeviceNet Bus Coupler offers automatic baud rate detection up to 500 kbaud and two address selection switches for address assignment. A 5-pin connector for the fieldbus connection is included in the scope of supply.</p>	 <p>The LC5200 "Low Cost" Bus Coupler is marked by a smaller design and a more economical connection method. All the bit-oriented terminals can be connected to the LC5200. All the digital input and output terminals are supported with the exception of the KL15xx, KL25x2, KL2692 and KL27x1 terminals. All the system terminals, with and without diagnostics, can also be connected.</p>
1 x open pluggable connector, 5-pin, included	1 x open pluggable connector, 5-pin, included	open style connector, 5-pin	connection via Bus Terminal
automatic detection up to 500 kbaud	automatic detection up to 500 kbaud	automatic detection up to 500 kbaud	automatic detection up to 500 kbaud
approx. 130 g	approx. 130 g	approx. 100 g	approx. 100 g
0...+55 °C	0...+55 °C	0...+55 °C	0...+55 °C
CE, UL, Ex, GL	CE, UL, Ex, GL	CE, UL, Ex	CE, UL, Ex
www.beckhoff.com/BK5210	www.beckhoff.com/BK5220	www.beckhoff.com/BK5250	www.beckhoff.com/LC5200
see page 608	see page 608	see page 608	see page 608
FC520x 704	FC520x 704	FC520x 704	FC520x 704

ControlNet, CC-Link, Modbus, Fipio | Bus Coupler

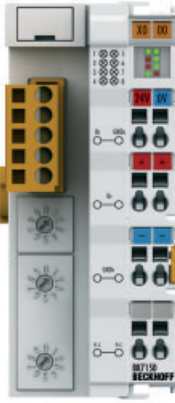

ControlNet.

CC-Link

	ControlNet Bus Coupler for up to 64 Bus Terminals	CC-Link "Compact" Bus Coupler for up to 64 Bus Terminals (255 with K-bus extension)
Technical data	BK7000	BK7150
Number of Bus Terminals	64	64 (255 with K-bus extension)
Max. number of bytes fieldbus	512 byte input and 512 byte output	32 byte input and 32 byte output
Current supply K-bus	1,750 mA	1,000 mA
	 <p>The Bus Coupler BK7000 connects the ControlNet bus system with the electronic terminal blocks, which can be extended in modular fashion. One unit consists of one Bus Coupler, any number from 1 to 64 terminals and one end terminal.</p> <p>The BK7000 Bus Coupler supports the operation of all Bus Terminals. As far as the user is concerned, handling of the analog inputs/outputs is not different to other series. The information is available in the process image of the controller for processing in the form of a byte array.</p>	 <p>The "Compact" Bus Coupler BK7150 connects the CC-Link system to the electronic terminal blocks, which can be extended in modular fashion.</p> <p>The BK7150 Bus Coupler supports the operation of all Bus Terminals. As far as the user is concerned, handling of the analog inputs/outputs is not different to other series. The information is available in the process image of the controller for processing in the form of a byte array.</p>
Bus interface	2 x BNC female connector + NAP	1 x open style connector, 5-pin, included
Data transfer rates	5 Mbaud	156 kbaud...10 Mbaud
Weight	approx. 170 g	approx. 100 g
Operating temperature	0...+55 °C	0...+55 °C
Approvals	CE, UL, Ex	CE, Ex
Further information	www.beckhoff.com/BK7000	www.beckhoff.com/BK7150
Accessories		
Cordsets and connectors	see page 608	see page 608
PC Fieldbus Cards	–	–

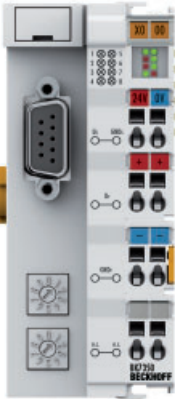

Modbus

Fipio





Modbus Bus Coupler for up to 64 Bus Terminals	Modbus "Compact" Bus Coupler for up to 64 Bus Terminals (255 with K-bus extension)	Fipio "Economy plus" Bus Coupler for up to 64 Bus Terminals (255 with K-bus extension)
BK7300	BK7350	BK7420
64	64 (255 with K-bus extension)	64 (255 with K-bus extension)
512 byte input and 512 byte output		64 byte input and 64 byte output
1,750 mA	1,000 mA	1,750 mA
 <p>The BK7300 Bus Coupler connects the Modbus bus system to the modular, extendable electronic terminal blocks. One unit consists of one Bus Coupler, any number from 1 to 64 terminals and one end terminal.</p>	 <p>The "Compact" BK7350 Bus Coupler is a cost-optimised version with compact housing. With the K-bus extension, up to 255 Bus Terminals can be connected.</p>	 <p>The BK7420 Bus Coupler links the Fipio bus system to the modular, extendable electronic terminal blocks. One unit consists of a Bus Coupler, any number of Bus Terminals between 1 and 64, and up to 255 terminals with the K-bus extension. The Bus Coupler automatically recognises the connected terminals and activates the relevant transfer profile.</p>
D-sub 9-pin, RS485 150 baud...38,400 baud approx. 170 g 0...+55 °C CE, UL, Ex, GL www.beckhoff.com/BK7300	D-sub 9-pin, RS485 150 baud...38,400 baud approx. 100 g 0...+55 °C CE, UL, Ex www.beckhoff.com/BK7350	1 x D-sub 9-pin socket with shielding automatic detection up to max. 1 Mbaud approx. 170 g 0...+55 °C CE, UL, Ex www.beckhoff.com/BK7420
see page 608	see page 608	see page 608
-	-	-

SERCOS, RS485/RS232, Ethernet | Bus Coupler



	SERCOS Bus Coupler for up to 64 Bus Terminals	SERCOS "Economy plus" Bus Coupler for up to 64 Bus Terminals (255 with K-bus extension)	RS485 Bus Coupler for up to 64 Bus Terminals
Technical data	BK7500	BK7520	BK8000
Number of Bus Terminals	64	64 (255 with K-bus extension)	64
Max. number of bytes fieldbus	32 byte input/32 byte output for the cyclic interface (depending on the master)	254 word I/O for the cyclic interface (depending on the master)	512 byte input and 512 byte output
Current supply K-bus	1,750 mA	1,750 mA	1,750 mA
	 <p>The Bus Coupler BK7500 connects the SERCOS bus system with the electronic terminal blocks, which can be extended in modular fashion. One unit consists of one Bus Coupler, any number from 1 to 64 terminals and one end terminal.</p> <ul style="list-style-type: none"> – distance between stations: 40 m plastic fibre optic 	 <p>Compared with the Bus Coupler BK7500, the BK7520 allows, with the K-bus extension technology, the connection of up to 255 Bus Terminals to one Bus Coupler. The Bus Coupler recognises the connected terminals and automatically generates the affiliations of the inputs/outputs to the bytes of the process image.</p> <ul style="list-style-type: none"> – distance between stations: 40 m plastic fibre optic 	 <p>The Bus Coupler BK8000 uses the physics of the RS485 specification for data transmission. Application of the Bus Coupler with a serial interface is suited to those cases in which the use of a fieldbus system can be omitted. The RS485 interface can be used by any automation device to gain access to the Bus Coupler. Data exchange is made via an open, documented protocol.</p>
Bus interface	F-SMA standard, IEC 872-2	F-SMA standard, IEC 872-2	RS485 D-sub
Data transfer rates	2/4 Mbaud, adjustable by means of configuration switch	2/4/8/16 Mbaud, adjustable by means of configuration switch	9.6 kbaud, 19.2 kbaud, 38.4 kbaud
Weight	approx. 170 g	approx. 170 g	approx. 170 g
Operating temperature	0...+55 °C	0...+55 °C	0...+55 °C
Approvals	CE, UL, Ex	CE, UL, Ex	CE, UL, Ex, GL
Further information	www.beckhoff.com/BK7500	www.beckhoff.com/BK7520	www.beckhoff.com/BK8000
Accessories			
Cordsets and connectors	see page 608	see page 608	see page 608
PC Fieldbus Cards	FC750x 705	FC750x 705	–
Communication software	–	–	KS8000 717

Ethernet



	RS232 Bus Coupler for up to 64 Bus Terminals	Ethernet TCP/IP Bus Coupler for up to 64 Bus Terminals	Ethernet TCP/IP "Compact" Bus Coupler for up to 64 Bus Terminals (255 with K-bus extension)	Ethernet TCP/IP Bus Coupler for up to 64 Bus Terminals (with integrated 2-channel switch)
	BK8100	BK9000	BK9050	BK9100
		64	64 (255 with K-bus extension)	64
		512 byte input and 512 byte output		
	1,750 mA	1,750 mA	1,000 mA	1,750 mA
	 <p>The Bus Coupler BK8100 uses the physics of the RS232C (V.24) specification for data transmission. Application of the Bus Coupler with a serial interface is suited to those cases in which the use of a fieldbus system can be omitted. The RS232 interface can be used by any automation device (e.g. a PC with RS232 interface) to gain access to the Bus Coupler.</p>	 <p>The BK9000 Bus Coupler connects Ethernet with the modular, extendable electronic terminal blocks. One unit consists of one Bus Coupler, any number from 1 to 64 terminals and one end terminal.</p> <ul style="list-style-type: none"> – distance between stations: 100 m between hub/switch and Bus Coupler 	 <p>The "Compact" BK9050 Bus Coupler is a cost-optimised version with compact housing. With the K-bus extension, up to 255 Bus Terminals can be connected.</p> <ul style="list-style-type: none"> – distance between stations: 100 m between hub/switch and Bus Coupler 	 <p>The BK9100 Bus Coupler connects Ethernet with the modular, extendable electronic terminal blocks. One unit consists of one Bus Coupler, any number from 1 to 64 terminals and one end terminal.</p> <ul style="list-style-type: none"> – distance between stations: 100 m between hub/switch and Bus Coupler or between Bus Coupler and Bus Coupler
	RS232 D-sub	1 x RJ 45	1 x RJ 45	2 x RJ 45 (2-channel switch)
	9.6 kbaud, 19.2 kbaud, 38.4 kbaud	10/100 Mbaud, automatic recognition of the transmission rate	10/100 Mbaud, automatic recognition of the transmission rate	10/100 Mbaud, automatic recognition of the transmission rate
	approx. 170 g	approx. 170 g	approx. 100 g	approx. 170 g
	0...+55 °C	0...+55 °C	0...+55 °C	-20...+60 °C
	CE, UL, Ex, GL	CE, UL, Ex, GL	CE, UL, Ex, GL	CE, UL, Ex, GL
	www.beckhoff.com/BK8100	www.beckhoff.com/BK9000	www.beckhoff.com/BK9050	www.beckhoff.com/BK9100
	see page 608	see page 608	see page 608	see page 608
	–	FC90xx 706	FC90xx 706	FC90xx 706
	KS8000 717	–	–	–

PROFINET, EtherNet/IP, USB | Bus Coupler





PROFINET "Compact" Bus Coupler
for up to 64 Bus Terminals
(255 with K-bus extension)

PROFINET Bus Coupler
for up to 64 Bus Terminals
(with integrated 2-channel switch)

Technical data	BK9053	BK9103
Number of Bus Terminals	64 (255 with K-bus extension)	
Max. number of bytes fieldbus	512 byte input and 512 byte output	
Current supply K-bus	1,750 mA	1,750 mA
	 <p>The BK9053 Bus Coupler connects PROFINET with the modular, extendable electronic terminal blocks. One unit consists of one Bus Coupler, any number from 1 to 64 terminals (255 with K-bus extension) and one end terminal.</p> <ul style="list-style-type: none"> – distance between stations: 100 m between hub/switch and Bus Coupler or between Bus Coupler and Bus Coupler 	 <p>The BK9103 Bus Coupler connects PROFINET IO with the modular, extendable electronic terminal blocks. One unit consists of one Bus Coupler, any number from 1 to 64 terminals (255 with K-bus extension) and one end terminal.</p> <ul style="list-style-type: none"> – distance between stations: 100 m between hub/switch and Bus Coupler or between Bus Coupler and Bus Coupler
Bus interface	1 x RJ 45	2 x RJ 45 (2-channel switch)
Data transfer rates	10/100 Mbaud, automatic recognition of the transmission rate	
Weight	approx. 100 g	approx. 170 g
Operating temperature	0...+55 °C	
Approvals	CE	CE, UL, Ex, GL
Further information	www.beckhoff.com/BK9053	www.beckhoff.com/BK9103
Accessories		
Cordsets and connectors	see page 608	see page 608
PC Fieldbus Cards	FC90xx 706	FC90xx 706
TwinCAT Supplement	PROFINET IO Controller 810	PROFINET IO Controller 810

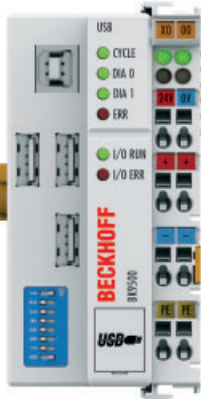

EtherNet/IP "Compact" Bus Coupler for up to 64 Bus Terminals (255 with K-bus extension)	EtherNet/IP Bus Coupler for up to 64 Bus Terminals (255 with K-bus extension)	USB Bus Coupler for up to 64 Bus Terminals
BK9055	BK9105	BK9500
64 (255 with K-bus extension)		64
512 byte input and 512 byte output		512 byte input and 512 byte output
1,000 mA	1,750 mA	1,750 mA (less downstream current)
 <p>The "Compact" BK9055 Bus Coupler is a cost-optimised version with compact housing. With the K-bus extension, up to 255 Bus Terminals can be connected.</p> <ul style="list-style-type: none"> distance between stations: 100 m between hub/switch and Bus Coupler 	 <p>The BK9105 Bus Coupler connects EtherNet/IP with the modular, extendable electronic terminal blocks. One unit consists of one Bus Coupler, any number from 1 to 64 terminals (255 with K-bus extension) and one end terminal.</p> <ul style="list-style-type: none"> distance between stations: 100 m between hub/switch and Bus Coupler or between Bus Coupler and Bus Coupler 	 <p>The Bus Coupler BK9500 connects the Universal Serial Bus (USB) system with the electronic terminal blocks, which can be extended in modular fashion. One unit consists of one Bus Coupler, any number from 1 to 64 terminals and one end terminal.</p> <ul style="list-style-type: none"> distance between stations: 30 m, 5 m from BK9500 to BK9500
1 x RJ 45	2 x RJ 45 (2-channel switch)	1 x B type (upstream), 3 x A type (downstream)
10/100 Mbaud, automatic recognition of the transmission rate	10/100 Mbaud, automatic recognition of the transmission rate	12 Mbaud
approx. 100 g	approx. 170 g	approx. 170 g
0...+55 °C	0...+55 °C	0...+55 °C
CE	CE, Ex, GL	CE, UL, Ex
www.beckhoff.com/BK9055	www.beckhoff.com/BK9105	www.beckhoff.com/BK9500
see page 608	see page 608	see page 608
FC90xx 706	FC90xx 706	-
-	-	driver included in TwinCAT

BCxxxx, BXxxxx | Bus Terminal Controllers

Controllers with fieldbus interface

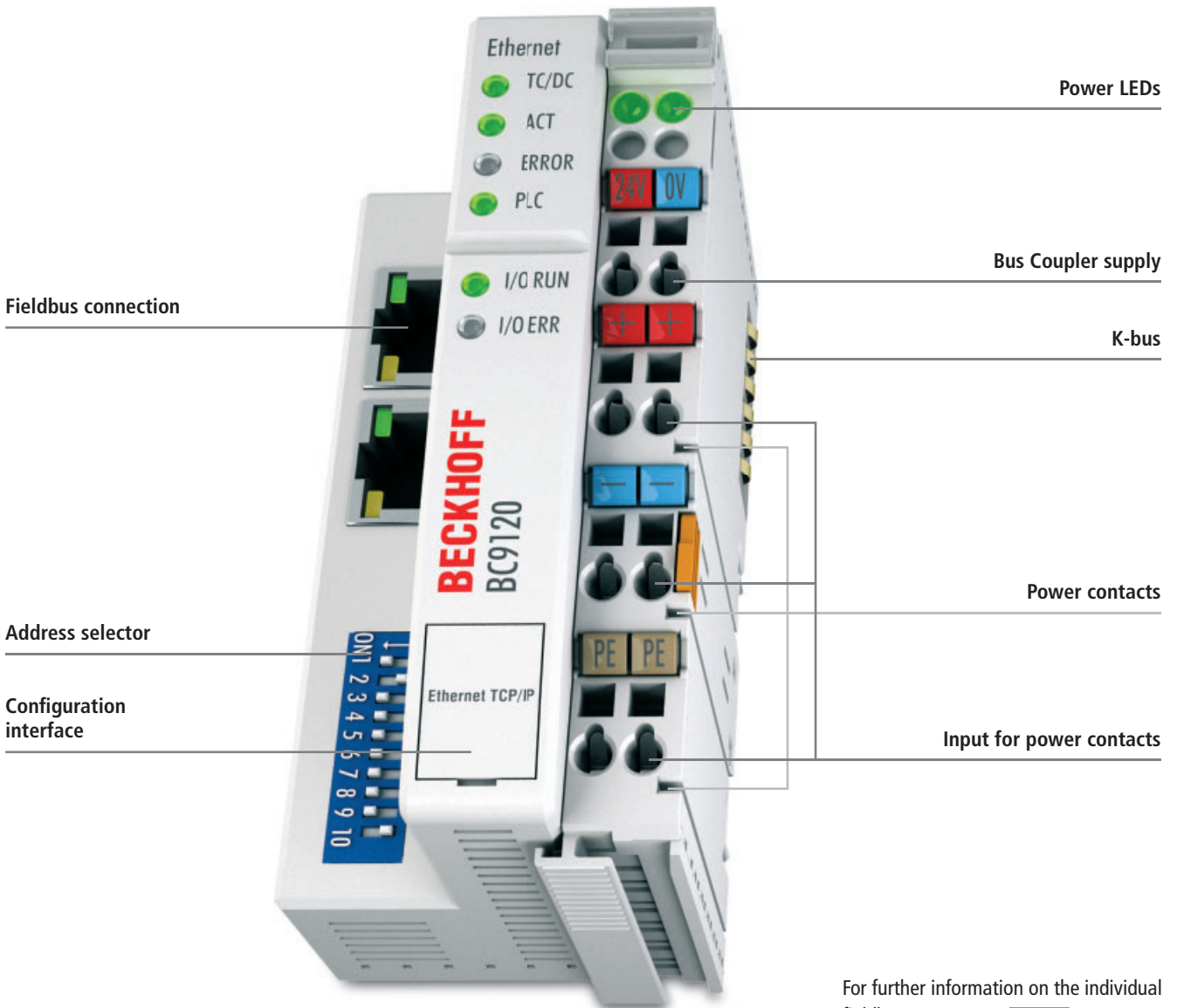

For further information on the individual fieldbuses see page [242](#)

Embedded PCs are alternatively available, see page [168](#)



BCxxxx | Bus Terminal
Controllers



BXxxxx | Bus Terminal
Controllers

The Bus Terminal Controllers of the BC and BX series are small controllers with a high degree of flexibility. The I/O system consisting of modularly expandable electronic terminal blocks, interfaces for all market-relevant fieldbus systems and the integrated IEC 61131-3 PLC enables the Bus Terminal Controllers to be used as stand-alone control systems or as intelligent fieldbus slaves. The Bus Terminal Controller is programmed using the TwinCAT programming system according to IEC 61131-3. The configuration or fieldbus interface of the controller is used for loading the PLC program.

The main distinguishing features between the BX series and the BC series are the larger memory capacity and a larger number of expandable interfaces.

The BCxx00 Bus Terminal Controllers form a unit consisting of the controller, any number (up to 64) of terminals and a bus end terminal. In contrast to the BCxx50, BCxx20 and BXxx00 series, a terminal bus extension cannot be used.

The "Compact" BCxx50 and BCxx20 Bus Terminal Controllers are fitted in cost-optimised, compact housings and support the K-bus extension (up to 255 Bus Terminals).

The devices of the BX family have two serial interfaces. The device itself comprises an illuminated LC display with 2 lines of 16 characters each, a joystick switch and a real-time clock. Further peripheral devices, e.g. displays, can be connected via the integrated Beckhoff Smart System Bus (SSB).





The Bus Terminal system has stood the test of time in machine or building automation applications where a temperature range of 0 to 55 °C is sufficient. For requirements beyond that, the operating temperature range of selected standard Bus Terminals and Couplers has been extended to -20 to +60 °C. The storage temperature of these ET components (Extended Temperature Range) has also been adapted and is now -40 to +85 °C. The exact definition of the operating conditions in temperature ranges outside 0 to 55 °C, installation requirements that possibly deviate from the standard and, if applicable, deviating technical data can be found in the documentation. Bus Terminal Controllers that have been qualified for the extended temperature range are identified accordingly.

Technical data	BCxxxx, BXxxxx
Power supply	24 V DC (-15 %/+20 %)
Programming	TwinCAT (via programming interface or fieldbus)
Programming languages	IEC 61131-3 (AWL, KOP, FUP, AS, ST)
Operating/storage temperature	0...+55 °C/-25...+85 °C (extended temperature range: -20...+60 °C/-40...+85 °C)
Relative humidity	95 %, no condensation
Vibration/shock resistance	conforms to EN 60068-2-6/EN 60068-2-27/29
EMC immunity/emission	conforms to EN 61000-6-2/EN 61000-6-4
Protect. class/installation pos.	IP 20/variable

Lightbus, PROFIBUS, Interbus, CANopen | Bus Terminal Controller

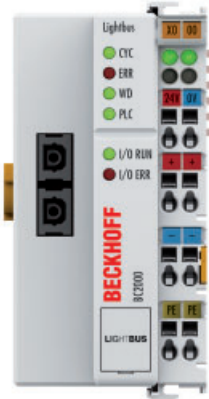

LIGHTBUS

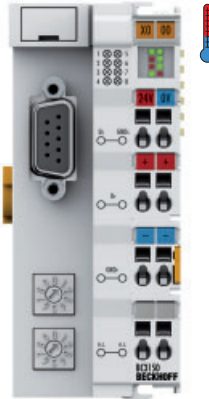

	Lightbus Bus Terminal Controller for up to 64 Bus Terminals	PROFIBUS Bus Terminal Controller for up to 64 Bus Terminals, 12 Mbaud	PROFIBUS "Compact" Bus Terminal Controller for up to 64 Bus Terminals (255 with K-bus extension), 12 Mbaud
Technical data	BC2000	BC3100	BC3150
Number of Bus Terminals	64	64	64 (255 with K-bus extension)
Max. number of bytes fieldbus	512 byte input and 512 byte output	128 byte input and 128 byte output	
Current supply K-bus	1,750 mA	1,750 mA	1,000 mA
	 <p>The Bus Terminal Controller BC2000 is a Bus Coupler with integrated PLC functionality and has a fieldbus interface for the Lightbus. The BC2000 is an intelligent slave and can be used as a non-central intelligence in the Lightbus system.</p>	 <p>The Bus Terminal Controller BC3100 is a Bus Coupler with integrated PLC functionality and has a fieldbus interface for PROFIBUS. It is an intelligent slave and can be used as distributed intelligence in the PROFIBUS system.</p>	 <p>The "Compact" BC3150 Bus Terminal Controller is housed in a cost-optimised and compact housing. Unlike the BC3100, the BC3150 supports up to 255 Bus Terminals via the K-bus extension.</p>
Bus interface	2 x standard fibre optic connector Z1000 (plastic fibre), Z1010 (HCS fibre)	1 x D-sub socket, 9-pin	1 x D-sub socket, 9-pin
Data transfer rates	2.5 Mbaud	automatic detection up to 12 Mbaud	automatic detection up to 12 Mbaud
Program memory	32/96 kbytes	32/96 kbytes	48 kbytes
Data memory	32/64 kbytes	32/64 kbytes	32 kbytes
Remanent data	512 bytes	512 bytes	2 kbytes
Online change	–	–	yes
Weight	approx. 170 g	approx. 170 g	approx. 100 g
Operating temperature	0...+55 °C	0...+55 °C	-20...+60 °C
Approvals	CE, UL, Ex	CE, UL, Ex, GL	CE, UL, Ex
Further information	www.beckhoff.com/BC2000	www.beckhoff.com/BC3100	www.beckhoff.com/BC3150
Accessories			
Cordsets and connectors	see page 608	see page 608	see page 608
PC Fieldbus Cards	FC200x 701	FC310x 702	FC310x 702
TwinCAT PLC	see page 794	see page 794	see page 794



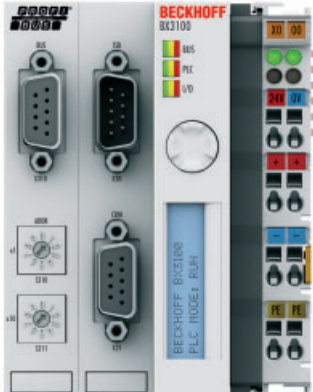

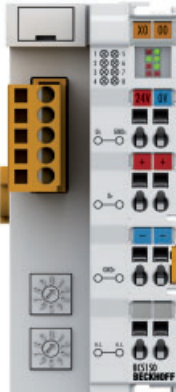
CANopen

<p>PROFIBUS Bus Terminal Controller for up to 64 Bus Terminals (255 with K-bus extension), 12 Mbaud</p>	<p>Interbus Bus Terminal Controller for up to 64 Bus Terminals</p>	<p>CANopen "Compact" Bus Terminal Controller for up to 64 Bus Terminals (255 with K-bus extension)</p>
<p>BX3100</p>	<p>BC4000</p>	<p>BC5150</p>
	<p>64</p>	<p>64 (255 with K-bus extension)</p>
<p>244 byte input and 244 byte output</p>	<p>64 byte input and 64 byte output</p>	<p>16 Tx/Rx PDOs</p>
<p>1,450 mA</p>	<p>1,750 mA</p>	<p>1,000 mA</p>
 <p>The BX3100 Bus Terminal Controller has a PROFIBUS slave interface with automatic baud rate detection up to 12 Mbaud and an address selection switch for address assignment.</p>	 <p>The Bus Terminal Controller BC4000 is a Bus Coupler with integrated PLC functionality and has a fieldbus interface for the Interbus. The BC4000 is an intelligent slave and can be used as a decentralised intelligence in the Interbus system.</p>	 <p>The "Compact" BC5150 Bus Terminal Controller for CANopen extends the Beckhoff small controller series by a cost-optimised version in a compact housing.</p>
<p>1 x D-sub socket, 9-pin</p>	<p>2 x D-sub plug, 9-pin, plug and socket with screening and vibration lock</p>	<p>open style connector, 5-pin</p>
<p>automatic detection up to 12 Mbaud</p>	<p>500 kbaud</p>	<p>automatic detection up to 1 Mbaud</p>
<p>256 kbytes</p>	<p>32/96 kbytes</p>	<p>48 kbytes</p>
<p>256 kbytes</p>	<p>32/64 kbytes</p>	<p>32 kbytes</p>
<p>2 kbytes</p>	<p>508 bytes</p>	<p>2 kbytes</p>
<p>yes</p>	<p>–</p>	<p>yes</p>
<p>approx. 250 g</p>	<p>approx. 170 g</p>	<p>approx. 100 g</p>
<p>0...+55 °C</p>	<p>0...+55 °C</p>	<p>-20...+60 °C</p>
<p>CE, UL</p>	<p>CE, UL, Ex</p>	<p>CE, UL, Ex</p>
<p>www.beckhoff.com/BX3100</p>	<p>www.beckhoff.com/BC4000</p>	<p>www.beckhoff.com/BC5150</p>
<p>see page 608</p>	<p>see page 608</p>	<p>see page 608</p>
<p>FC310x 702</p>	<p>–</p>	<p>FC510x 703</p>
<p>see page 794</p>	<p>see page 794</p>	<p>see page 794</p>



DeviceNet, Modbus, RS485/RS232 | Bus Terminal Controller



	CANopen Bus Terminal Controller for up to 64 Bus Terminals (255 with K-bus extension)	DeviceNet "Compact" Bus Terminal Controller for up to 64 Bus Terminals (255 with K-bus extension)	DeviceNet Bus Terminal Controller for up to 64 Bus Terminals (255 with K-bus extension)
Technical data	BX5100	BC5250	BX5200
Number of Bus Terminals	64 (255 with K-bus extension)	64 (255 with K-bus extension)	
Max. number of bytes fieldbus	32 Tx/Rx PDOs	512 byte input and 512 byte output	
Current supply K-bus	1,450 mA	1,000 mA	1,450 mA
	 <p>The BX5100 Bus Terminal Controller has a CANopen slave interface. It has automatic baud rate detection up to 1 Mbaud and an address selection switch for address assignment.</p>	 <p>The "Compact" BC5250 Bus Terminal Controller with DeviceNet interface extends the Beckhoff small controller series by a cost-optimised version in a compact housing. The DeviceNet Controller offers automatic baud rate detection up to 500 kbaud and two address selection switches for address assignment.</p>	 <p>The BX5200 Bus Terminal Controller has a DeviceNet slave interface. It has automatic baud rate detection up to 500 kbaud and an address selection switch for address assignment. Up to 512 byte of input and 512 byte of output can be exchanged with the controller.</p>
Bus interface	open style connector, 5-pin	open style connector, 5-pin	open style connector, 5-pin
Data transfer rates	automatic detection up to 1 Mbaud	automatic detection up to 500 kbaud	automatic detection up to 500 kbaud
Program memory	256 kbytes	48 kbytes	256 kbytes
Data memory	256 kbytes	32 kbytes	256 kbytes
Remanent data	2 kbytes	2 kbytes	2 kbytes
Online change	yes	yes	yes
Weight	approx. 250 g	approx. 100 g	approx. 250 g
Operating temperature	0...+55 °C	0...+55 °C	0...+55 °C
Approvals	CE, UL	CE, UL, Ex	CE, UL
Further information	www.beckhoff.com/BX5100	www.beckhoff.com/BC5250	www.beckhoff.com/BX5200
Accessories			
Cordsets and connectors	see page 608	see page 608	see page 608
PC Fieldbus Cards	FC510x 703	FC520x 704	FC520x 704
TwinCAT PLC	see page 794	see page 794	see page 794



Modbus

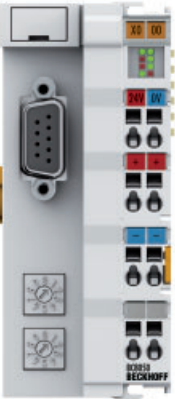



Modbus RS485 Bus Terminal Controller for up to 64 Bus Terminals	RS485 Bus Terminal Controller for up to 64 Bus Terminals	RS485 "Compact" Bus Terminal Controller for up to 64 Bus Terminals (255 with K-bus extension)
BC7300	BC8000	BC8050
64	64	64 (255 with K-bus extension)
512 byte input and 512 byte output	512 byte input and 512 byte output	
1,750 mA	1,750 mA	1,000 mA
 <p>The Bus Terminal Controller BC7300 is a Bus Coupler with integrated PLC functionality and has a fieldbus interface for Modbus. The BC7300 is an intelligent slave and can be used as a non-central intelligence in the Modbus system.</p>	 <p>The Bus Terminal Controller BC8000 is a Bus Coupler with integrated PLC functionality and has an RS485 interface. The programmable interface is suitable for the connection of serial devices. The protocol can be freely programmed. The serial interface then functions as a master.</p>	 <p>The "Compact" Bus Terminal Controller BC8050 with serial RS485 interface extends the Beckhoff small controller series by a cost-optimised version in a compact housing. An open serial protocol – like in the BK8x00 Bus Couplers – and the Modbus RTU/ASCII protocol are implemented. The address and the protocol are selected via the two rotary selection switches.</p>
D-sub 9-pin, RS485 150, 300, 600, 1,200, 2,400, 4,800, 9,600, 19,200, 38,400 baud (default: 9,600 baud) 32/96 kbytes 32/64 kbytes 512 bytes – approx. 170 g 0...+55 °C CE, UL, Ex, GL www.beckhoff.com/BC7300	RS485 D-sub 1.2 kbaud...57.6 kbaud 32/96 kbytes 32/64 kbytes 512 bytes – approx. 170 g 0...+55 °C CE, UL, Ex, GL www.beckhoff.com/BC8000	RS485 D-sub 1.2 kbaud...38.4 kbaud 48 kbytes 32 kbytes 2 kbytes yes approx. 100 g 0...+55 °C CE www.beckhoff.com/BC8050
see page 608	see page 608	see page 608
–	–	–
see page 794	see page 794	see page 794

RS232/RS485, Ethernet | Bus Terminal Controller



	RS232 Bus Terminal Controller for up to 64 Bus Terminals	RS232 "Compact" Bus Terminal Controller for up to 64 Bus Terminals (255 with K-bus extension)	RS232/RS485 Bus Terminal Controller for up to 64 Bus Terminals (255 with K-bus extension)
Technical data	BC8100	BC8150	BX8000
Number of Bus Terminals	64	64 (255 with K-bus extension)	
Max. number of bytes fieldbus	512 byte input and 512 byte output		
Current supply K-bus	1,750 mA	1,000 mA	1,450 mA
	 <p>The BC8100 Bus Terminal Controller is a Bus Coupler with integrated PLC functionality and has a RS232 interface, with which peer-to-peer connection is possible. The programmable interface is suitable for the connection of serial devices. The protocol can be freely programmed.</p>	 <p>The "Compact" Bus Terminal Controller BC8150 with serial RS232 interface extends the Beckhoff small controller series by a cost-optimised version in a compact housing. An open serial protocol – like in the BK8x00 Bus Couplers – and the Modbus RTU/ASCII protocol are implemented.</p>	 <p>The BX8000 Bus Terminal Controller is a stand-alone PLC. One unit consists of the BX8000 Bus Terminal Controller with up to 64 Bus Terminals and a bus end terminal. With the terminal bus extension system, the connection of up to 255 Bus Terminals is possible. The controller is programmed via the COM1 interface.</p>
Bus interface	RS232 D-sub	RS232 D-sub	open style connector, 5-pin
Data transfer rates	1.2 kbaud...57.6 kbaud	1.2 kbaud...38.4 kbaud	300 baud...115 kbaud
Program memory	32/96 kbytes	48 kbytes	256 kbytes
Data memory	32/64 kbytes	32 kbytes	256 kbytes
Remanent data	512 bytes	2 kbytes	2 kbytes
Online change	–	yes	yes
Weight	approx. 170 g	approx. 100 g	approx. 250 g
Operating temperature	0...+55 °C	0...+55 °C	0...+55 °C
Approvals	CE, UL, Ex	CE, UL, Ex	CE, UL
Further information	www.beckhoff.com/BC8100	www.beckhoff.com/BC8150	www.beckhoff.com/BX8000
Accessories			
Cordsets and connectors	see page 608	see page 608	see page 608
PC Fieldbus Cards	–	–	–
TwinCAT PLC	see page 794	see page 794	see page 794

Ethernet

Ethernet Bus Terminal Controller for up to 64 Bus Terminals	Ethernet "Compact" Bus Terminal Controller for up to 64 Bus Terminals (255 with K-bus extension)	Ethernet TCP/IP "Economy plus" Bus Terminal Controller for up to 64 Bus Terminals (255 with K-bus extension)
BC9000	BC9050	BC9020
64	64 (255 with K-bus extension)	
512 byte input and 512 byte output		
1,750 mA	1,000 mA	1,750 mA
 <p>The Bus Terminal Controller BC9000 is a Bus Coupler with integrated PLC functionality and has a fieldbus interface for Ethernet. It is an intelligent slave that can be used as a non-central intelligence in the Ethernet system. One unit consists of the Bus Terminal Controller, any number of terminals between 1 and 64, and a bus end terminal.</p>	 <p>The "Compact" BC9050 Bus Terminal Controller with Ethernet interface extends the Beckhoff small controller series by a cost-optimised version in a compact housing.</p>	 <p>The BC9020 "Economy plus" Bus Terminal Controller is a Bus Coupler with integrated PLC functionality and has a fieldbus interface for Ethernet. It is an intelligent slave and can be used as decentralised intelligence in the Ethernet system.</p>
<p>1 x RJ 45</p> <p>10/100 Mbaud, automatic recognition of the transmission rate</p> <p>64/96 kbytes</p> <p>64/128 kbytes</p> <p>4,080 bytes</p> <p>–</p> <p>approx. 170 g</p> <p>0...+55 °C</p> <p>CE, UL, Ex, GL</p> <p>www.beckhoff.com/BC9000</p>	<p>1 x RJ 45</p> <p>10/100 Mbaud, automatic recognition of the transmission rate</p> <p>48 kbytes</p> <p>32 kbytes</p> <p>2 kbytes</p> <p>yes</p> <p>approx. 100 g</p> <p>0...+55 °C</p> <p>CE, UL, Ex</p> <p>www.beckhoff.com/BC9050</p>	<p>1 x RJ 45</p> <p>10/100 Mbaud, automatic recognition of the transmission rate</p> <p>128 kbytes</p> <p>128 kbytes</p> <p>2 kbytes</p> <p>yes</p> <p>approx. 170 g</p> <p>0...+55 °C</p> <p>CE, UL, Ex, GL</p> <p>www.beckhoff.com/BC9020</p>
see page	see page	see page
608	608	608
FC90xx	FC90xx	FC90xx
706	706	706
see page	see page	see page
794	794	794

Ethernet | Bus Terminal Controller

Ethernet

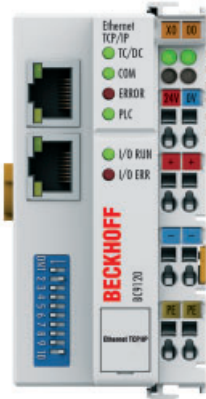
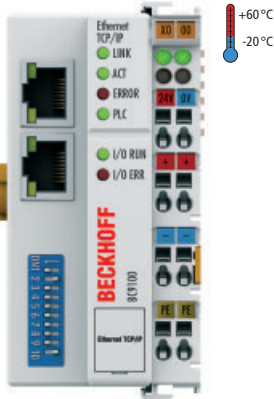
	Ethernet TCP/IP "Economy plus" Bus Terminal Controller for up to 64 Bus Terminals (255 with K-bus extension, with integrated 2-channel switch)	Ethernet TCP/IP Bus Terminal Controller for up to 64 Bus Terminals (with integrated 2-channel switch)
Technical data	BC9120	BC9100
Number of Bus Terminals	64 (255 with K-bus extension)	64
Max. number of bytes fieldbus	512 byte input and 512 byte output	
Current supply K-bus	1,750 mA	1,750 mA
	 <p>In contrast to the BC9020, the BC9120 has an additional RJ 45 port. Both Ethernet ports operate as 2-channel switches.</p>	 <p>The Bus Terminal Controller BC9100 is a Bus Coupler with integrated PLC functionality and has a fieldbus interface for Ethernet. The BC9100 is an intelligent slave and can be used as a non-central intelligence in the Ethernet system.</p>
Bus interface	2 x RJ 45 (2-channel switch)	2 x RJ 45 (2-channel switch)
Data transfer rates	10/100 Mbaud, automatic recognition of the transmission rate	10/100 Mbaud, automatic recognition of the transmission rate
Program memory	128 kbytes	64/96 kbytes
Data memory	128 kbytes	64/128 kbytes
Remanent data	2 kbytes	4,080 bytes
Online change	yes	–
Weight	approx. 170 g	approx. 170 g
Operating temperature	0...+55 °C	-20...+60 °C
Approvals	CE, UL, Ex, GL	CE, UL, Ex, GL
Further information	www.beckhoff.com/BC9120	www.beckhoff.com/BC9100
Accessories		
Cordsets and connectors	see page 608	see page 608
PC Fieldbus Cards	FC90xx 706	FC90xx 706
TwinCAT PLC	see page 794	see page 794

Ethernet Room Controller

<p>Ethernet Bus Terminal Controller for up to 64 Bus Terminals (255 with K-bus extension)</p>	<p>Building Automation Room Controller</p>
<p>BX9000</p>	<p>BC9191</p>
<p>64 (255 with K-bus extension)</p>	<p>64</p>
<p>1,450 mA</p>	<p>512 byte input and 512 byte output</p>
<div data-bbox="132 783 448 1187" data-label="Image"> </div> <p>The BX9000 Bus Terminal Controller has an Ethernet slave/master interface. The controller has automatic baud rate detection up to 100 Mbaud. The address can optionally be entered via DHCP, BootP, ARP or with the joystick switch.</p>	<div data-bbox="794 783 1193 1187" data-label="Image"> </div> <p>Digital inputs: – 3 x 24 V DC Analog inputs: – 3 x 0...10 V; 1 x PT/Ni1000 (-20...+60 °C); 1 x resistance measurement for set value specification</p> <p>Digital outputs: – 1 x 230 V AC, 10 A, relay; 3 x 230 V AC, 1 A, relay; 2 x 230 V AC, 1 A, triac Analog outputs: – 2 x 0...10 V</p>
<p>RJ 45</p>	<p>2 x RJ 45 (switched)</p>
<p>10/100 Mbaud, automatic recognition of the transmission rate</p>	<p>10/100 Mbaud, automatic recognition of the transmission rate</p>
<p>256 kbytes</p>	<p>48 kbytes</p>
<p>256 kbytes</p>	<p>32 kbytes</p>
<p>2 kbytes</p>	<p>2 kbytes</p>
<p>yes</p>	<p>yes</p>
<p>approx. 250 g</p>	<p>approx. 375 g</p>
<p>0...+55 °C</p>	<p>0...+55 °C</p>
<p>CE, UL</p>	<p>CE</p>
<p>www.beckhoff.com/BX9000</p>	<p>www.beckhoff.com/BC9191</p>
<p>see page 608</p>	<p>see page 608</p>
<p>FC90xx 706</p>	<p>FC90xx 706</p>
<p>see page 794</p>	<p>see page 794</p>

i For availability status see Beckhoff website at: www.beckhoff.com/BC9191

KLxxxx | Bus Terminals

The Bus Terminals have a galvanic isolation between the field level and the communication level (K-bus). A terminal is equipped with 1...n input or output channels. The channels within a terminal are usually not electrically isolated from each other.

The terminals are supplied with field voltage by the power contacts which are available on the left hand side, provided that the terminals have power contacts. Depending on the terminals 24 V DC, 230 V AC or other voltages are transferred by the power contacts. The supply power required for each terminal, which is provided through the power contacts, is listed in the technical data of each terminal. The maximum load of the power contacts is 10 A.

Some 2-channel Bus Terminals have a PE power contact, which can be used for PE distribution by connecting it together with similar terminals. The EMC spring contact on the underside of the terminal only serves to remove interference ⚡ and may not be used as a protective earth ⚡.

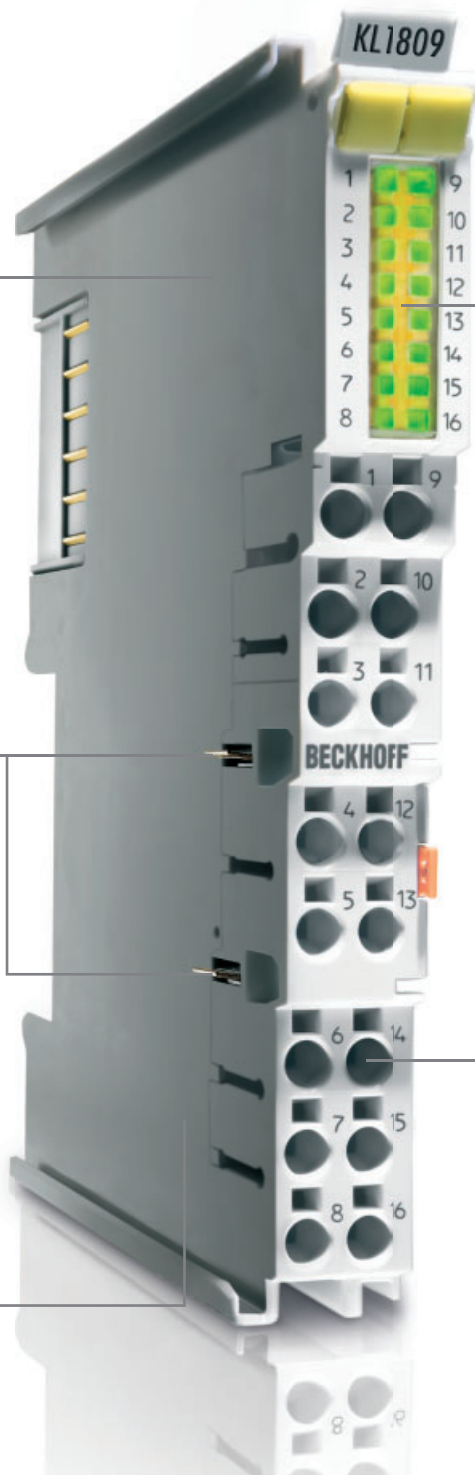

Beckhoff Bus Terminals feature function-dependant coloured labels: yellow for digital inputs, red for digital outputs, green for analog inputs, blue for analog outputs. The LED frames for HD Bus Terminals are also colour-coded accordingly.

Different field level connection techniques can be used for Bus Terminals:

- standard terminal point: 0.08...2.5 mm² spring force technology
- HD Bus Terminal: 0.08...0.75 mm² (with ferrule); 0.08...1.5 mm² (single-wire); spring force technology; direct plug-in technique
- ribbon: especially used in Asia for digital input/output channels
- plug-in wiring level: KS terminals

Technical data see page 487

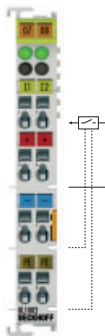

2-channel terminals

The 2-channel terminals provide additional power (+24 V DC), ground (0 V DC) and in many cases also PE for each channel. Connection is carried out with 3- or 4-wire connection.



4-channel terminals

Along with four channels the 4-channel terminals have another four connection points available. These can provide 24 V DC or ground. Connection is carried out with 2-wire connection.

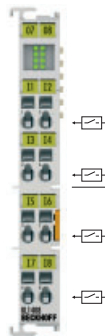

8-channel terminals

The 8-channel terminals have one channel per connection point due to a high packing density. The power contact of the terminal will be used as the common reference potential. Connection is carried out with 1-wire connection.

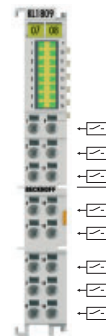

16-channel terminals

The HD (High Density) housing allows 16 channels to be accommodated on a unit that is only 12 mm wide. The power contact of the terminal will be used as the common reference potential. Connection is carried out with 1-wire connection.

The Bus Terminals offer the possibility to directly connect many different signals. No signal converter or additional evaluation device is needed. The direct connection reduces the costs and simplifies the control technology. Each Bus Terminal separates the internal electronics from the connection level and thus simplifies the creation of voltage groups with different voltages. In addition, interfering voltages on the signal connector lose their adverse effects.

The KL1xxx, KL2xxx Bus Terminal product family is designed for the processing of digital or binary signals. There are "High" and "Low" states. In the positive switching logic the High state corresponds to the level of the supply voltage, the Low state corresponds to ground level. For negative switching logic it is the other way around. The Bus Terminal product family supports both types of logic for

various supply voltages. 1-, 2-, 3- and 4-wire connections allow the use of Bus Terminals in almost all applications without further wiring work.

The KL3xxx and KL4xxx Bus Terminal product family processes analog signals. The most commonly used are 0...10 V, ±10 V, 0...20 mA and 4...20 mA. Also many other industry-standard voltage and current signals are supported and pre-processed.

In the KL5xxx and KL6xxx Bus Terminal product families other complex signals, such as position values and digital interfaces, are supported. Some Bus Terminals act as field-bus masters for subordinate bus systems. The Bus Terminal station thus becomes a universal gateway between different systems.

The KL9xxx system terminals round off the application of Bus Terminals with power feed and power supply units.



The Bus Terminal system has stood the test of time in machine or building automation applications where a temperature range of 0 to +55 °C is sufficient. For requirements beyond that, the operating temperature range of selected standard Bus Terminals and couplers was extended to -20 to +60 °C. The storage temperature of these ET components (Extended Temperature Range) has also been adapted and is now -40 to +85 °C. The exact definition of the operating conditions in temperature ranges outside 0 to +55 °C, installation requirements that possibly deviate from the standard and, if applicable, deviating technical data can be found in the documentation. Bus Terminals which are suited to the extended temperature range are marked accordingly.

Technical data	KLxxxx KSxxxx
Electrical isolation	500 V (K-bus/field voltage); is not indicated otherwise
Operating/storage temperature	0...+55 °C/-25...+85 °C (terminals with extended temperature range: -20...+60 °C/-40...+85 °C)
Relative humidity	95 %, no condensation
Vibration/shock resistance	conforms to EN 60068-2-6/EN 60068-2-27/29
EMC immunity/emission	conforms to EN 61000-6-2/EN 61000-6-4
Protect. class/installation pos.	IP 20/variable (see documentation)

Digital input | 24 V DC, positive switching

The digital inputs of a 24 V supply are among the most used signals. The EN 61131-2 standard describes the input characteristic and distinguishes three types. Type 1 has a small input current with low power dissipation. This input is optimised for mechanical switches and actively-switched electronic outputs. Type 2 has a significantly larger input current and is optimised for 2-wire sensors with a high quiescent current consumption. In switched-on state the current consumption of this input is high. The related power dissipation is generally not acceptable. Type 3 is a combination between type 1, with low current in switched-on state, and a satisfactorily high quiescent current for the majority of modern 2-wire sensors. The type 3 input can be used in almost all applications as a replacement for type 1.

The diagram shows the typical current/voltage curves of the Bus Terminal inputs and the allowable range of conformity in accordance with the standard.

The input circuits differ in their filtering functions. The filtering has the task of suppressing electromagnetic interference. However, this does have the drawback of signal deceleration. The filter time of 3 ms is comparatively slow, but it can suppress the bouncing of a mechanical switch and delivers a stable signal for simple PLC applications. Filter times of 0.2 ms are suitable for applications with shortest possible reaction times and should be used for mechanical switches only in a restricted manner.

8-channel digital input terminal, 24 V DC, 1-wire, type 1/3

Technical data	KL1408 KS1408	KL1418 KS1418
Connection technology	1-wire	
Specification	EN 61131-2, type 1/3	
Input filter	typ. 3.0 ms	typ. 0.2 ms
Number of inputs	8	

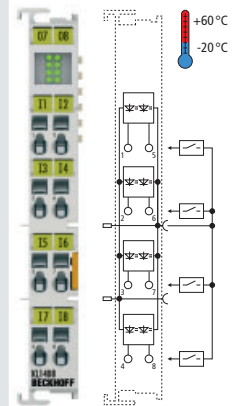

The KL1408 and KL1418 digital input terminals have eight inputs, which are each assigned to a connection point. This way, a high packing density can be achieved for signal sources with common grounds.

Nominal voltage	24 V DC (-15 %/+20 %)	
Current consumption power contacts	typ. 2 mA + load	
Current consumpt. K-bus	typ. 5 mA	
Operating temperature	-20...+60 °C	
Approvals	CE, UL, Ex, GL	
Weight	approx. 55 g	
Further information	www.beckhoff.com/KL1408	

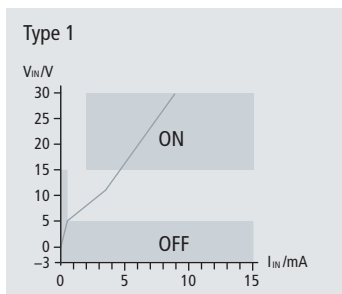

Signal voltage "0": -3...5 V DC
Signal voltage "1": 15...30 V DC

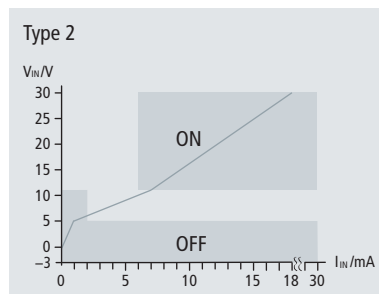

Signal voltage "0": -3...5 V DC
Signal voltage "1": 11...30 V DC

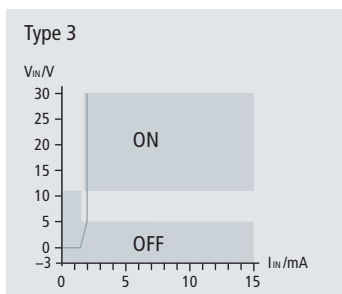

Signal voltage "0": -3...5 V DC
Signal voltage "1": 11...30 V DC

Characteristics of the 3 input types according to EN 61131-2 (24 V DC)

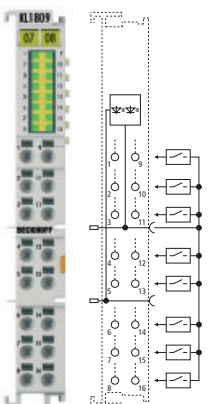
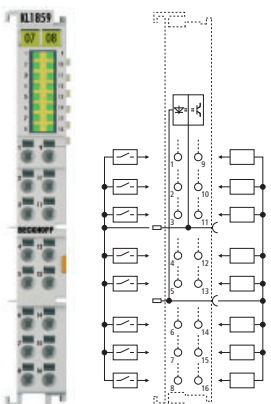
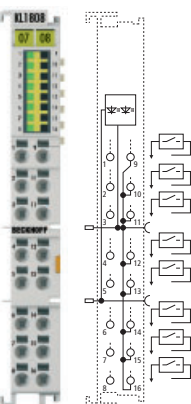
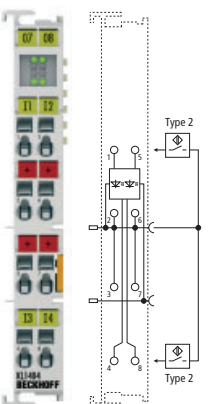
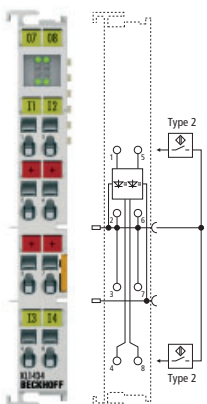
16-channel digital input terminal, 24 V DC, 1-wire, type 1/3		8-channel digital input + 8-channel digital output, 24 V DC, 1-wire, type 1/3	8-channel digital input terminal, 24 V DC, 2-wire, type 1/3	4-channel digital input terminal, 24 V DC, 2-wire, type 1/3	4-channel digital input terminal, 24 V DC, 2-wire, type 2
KL1809	KL1819	KL1859	KL1808	KL1404 KS1404	KL1414 KS1414
			2-wire		KL1434
					EN 61131-2, type 2
typ. 3.0 ms		typ. 3.0 ms	typ. 3.0 ms	typ. 3.0 ms	typ. 0.2 ms
16		8 inputs + 8 outputs	8	4	4
 <p>The HD (High Density) Bus Terminals with higher packing density contain 16 terminal points housed in a 12 mm terminal block.</p>		 <p>The KL1859 digital Bus Terminal combines eight digital inputs and eight digital outputs in one device.</p> <ul style="list-style-type: none"> – number of outputs: 8 – max. output current: 0.5 A (per channel) – load type: ohmic, inductive, lamp load – reverse voltage protection: yes 	 <p>The KL1808 HD (High Density) Bus Terminal has eight inputs and eight 24 V connections, which are suitable for the connection of 2-wire sensors.</p>	 <p>The KL1404 and KL1414 digital input terminals are suitable for the connection of four 2-wire sensors.</p>	 <p>The KL1434 digital input terminal is suitable for the connection of four 2-wire sensors of type 2 (EN 61131-2).</p>
24 V DC (-15 %/+20 %)		24 V DC (-15 %/+20 %)	24 V DC (-15 %/+20 %)	24 V DC (-15 %/+20 %)	24 V DC (-15 %/+20 %)
typ. 4 mA + load		typ. 15 mA + load	typ. 2 mA + load	typ. 1 mA + load	only load
typ. 20 mA		typ. 25 mA	typ. 15 mA	typ. 3 mA	typ. 3 mA
0...+55 °C		0...+55 °C	0...+55 °C	0...+55 °C	0...+55 °C
CE, Ex		CE, Ex	CE, Ex	CE, UL, Ex, GL	CE, UL, Ex
approx. 60 g		approx. 60 g	approx. 60 g	approx. 50 g	approx. 50 g
www.beckhoff.com/KL1809		www.beckhoff.com/KL1859	www.beckhoff.com/KL1808	www.beckhoff.com/KL1404	www.beckhoff.com/KL1434

Digital input | 24 V DC, positive switching

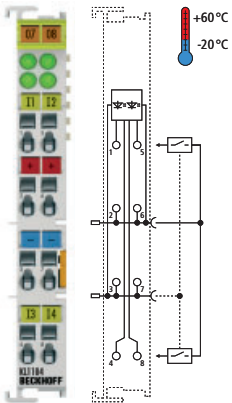
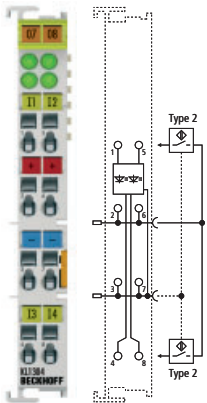
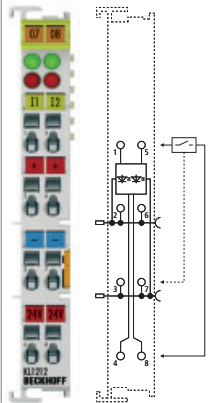
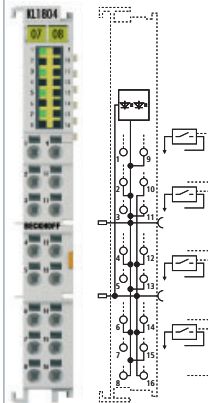
	4-channel digital input terminal, 24 V DC, 2-/3-wire, type 1/3		4-channel digital input terminal, 24 V DC, 2-/3-wire, type 2		2-channel digital input terminal, 24 V DC, with short-circuit protected sensor supply and diagnostics, 3-wire, type 1		4-channel digital input terminal, 24 V DC, 3-wire, type 1/3	
Technical data	KL1104 KS1104	KL1114 KS1114	KL1304 KS1304	KL1314 KS1314	KL1212 KS1212		KL1804	KL1814
Connection technology	2-/3-wire				3-wire			
Specification	EN 61131-2, type 1/3		EN 61131-2, type 2		EN 61131-2, type 1		EN 61131-2, type 1/3	
Input filter	typ. 3.0 ms	typ. 0.2 ms	typ. 3.0 ms	typ. 0.2 ms	typ. 3.0 ms		typ. 3.0 ms	typ. 0.2 ms
Number of inputs	4		4		2		4	
	 <p>The KL1104 and KL1114 digital input terminals have four inputs and also provide 24 V DC and ground per channel.</p>		 <p>The KL1304 and KL1314 digital input terminals have four inputs and also provide 24 V DC and ground per channel. The terminals are especially suitable for sensors which require a high quiescent current.</p>		 <p>The KL1212 digital input terminal contains two inputs, which are suitable for the connection of 3-wire sensors. The terminal offers a short-circuit-proof sensor supply voltage with integrated diagnostic. A short-circuit or an open lead in the sensor supply is detected and the terminal status is relayed to the controller via the K-bus.</p>		 <p>The KL1804 and KL1814 HD Bus Terminals contain four inputs, 24 V and ground connections, which are suitable for the application of 3-wire sensors.</p>	
Nominal voltage	24 V DC (-15 %/+20 %)		24 V DC (-15 %/+20 %)		24 V DC (-15 %/+20 %)		24 V DC (-15 %/+20 %)	
Current consumption power contacts	only load		only load		only load		typ. 1 mA + load	
Current consumpt. K-bus	typ. 5 mA		typ. 3 mA		typ. 8 mA		typ. 10 mA	
Operating temperature	-20...+60 °C		0...+55 °C		0...+55 °C		0...+55 °C	
Approvals	CE, UL, Ex, GL		CE, UL, Ex		CE, UL, Ex, GL		CE, Ex	
Weight	approx. 55 g		approx. 50 g		approx. 55 g		approx. 60 g	
Further information	www.beckhoff.com/KL1104		www.beckhoff.com/KL1304		www.beckhoff.com/KL1212		www.beckhoff.com/KL1804	
Special terminals								
Distinguishing features								

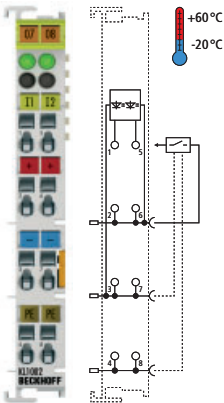
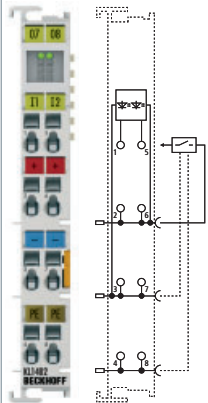
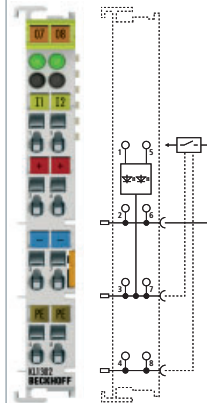
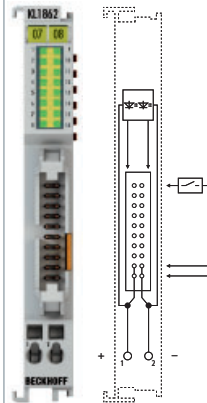
2-channel digital input terminal, 24 V DC, 4-wire, type 1/3		2-channel digital input terminal, 24 V DC, 4-wire, type 1/3		2-channel digital input terminal, 24 V DC, 4-wire, type 2		16-channel digital input terminal, 24 V DC, 1-wire, flat-ribbon cable connection, type 1/3	
KL1002 KS1002	KL1012 KS1012	KL1402 KS1402	KL1412 KS1412	KL1302 KS1302	KL1312 KS1312	KL1862	KL1872
4-wire						flat-ribbon cable	
				EN 61131-2, type 2		EN 61131-2, type 1/3	
typ. 3.0 ms	typ. 0.2 ms	typ. 3.0 ms	typ. 0.2 ms	typ. 3.0 ms	typ. 0.2 ms	typ. 3.0 ms	typ. 0.2 ms
2		2		2		16	
 <p>The KL1002 and KL1012 digital input terminals have two inputs, which are suitable for the connection of 4-wire sensors.</p>		 <p>The current/voltage characteristics have been optimised for 4-wire sensors. The input current in low state is increased to a minimum value of 1.5 mA and therefore supports the majority of commercially available 4-wire sensors. A typical value for the energy-saving high current is 2.2 mA.</p>		 <p>The KL1302 and KL1312 digital input terminals have two inputs, which are suitable for the connection of 4-wire sensors. The terminals are especially suitable for sensors which require a high quiescent current.</p>		 <p>A 20-pin plug connector with 2.54 mm contact spacing enables the secure connection of plug connectors using insulation displacement contact, as is usual for ribbon cables and special round cables. The required 24 V DC voltage supply must be input by the ribbon cable or the terminal points.</p>	
24 V DC (-15 %/+20 %)		24 V DC (-15 %/+20 %)		24 V DC (-15 %/+20 %)		24 V DC (-15 %/+20 %)	
only load		typ. 1 mA + load		only load		typ. 4 mA from the 24 V supply (no power contacts)	
typ. 3 mA		typ. 3 mA		typ. 3 mA		typ. 3 mA	
-20...+60 °C		0...+55 °C		0...+55 °C		0...+55 °C	
CE, UL, Ex, GL		CE, Ex		CE, UL, Ex		CE	
approx. 50 g		approx. 50 g		approx. 50 g		approx. 50 g	
www.beckhoff.com/KL1002		www.beckhoff.com/KL1402		www.beckhoff.com/KL1302		www.beckhoff.com/KL1862	
						KL1862-0010	
						negative switching	

Digital input | 24 V DC, negative switching

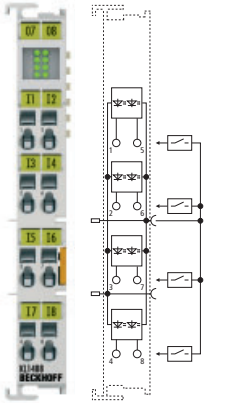
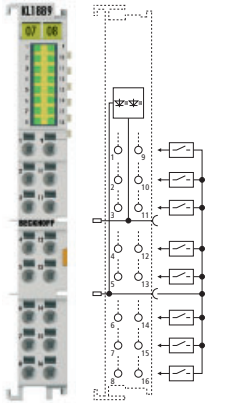
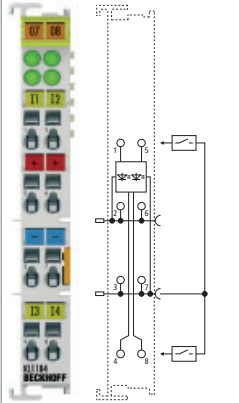
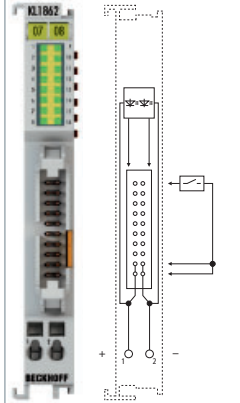
	8-channel digital input terminal, 24 V DC, 1-wire		16-channel digital input terminal, 24 V DC, 1-wire		4-channel digital input terminal, 24 V DC, 2-/3-wire		16-channel digital input terminal, 24 V DC, 1-wire, flat-ribbon cable									
Technical data	KL1488 KS1488		KL1498 KS1498		KL1889		KL1184 KS1184		KL1194 KS1194		KL1862-0010					
Connection technology	1-wire					2-/3-wire		flat-ribbon cable								
Specification	negative switching															
Input filter	typ. 3.0 ms		typ. 0.2 ms		typ. 3.0 ms		typ. 3.0 ms		typ. 0.2 ms		typ. 3.0 ms					
Number of inputs	8				16				4				16			
	 <p>The negative switching KL1488 and KL1498 digital input terminals are suitable for the connection of eight sensors by 1-wire technology.</p>				 <p>The HD (High Density) Bus Terminals with higher packing density contain 16 terminal points housed in a 12 mm terminal block.</p>				 <p>Negative switching sensors can be connected to the KL1184 and KL1194 digital input terminals.</p>				 <p>A 20-pin plug connector with 2.54 mm contact spacing enables the secure connection of plug connectors using insulation displacement contact, as is usual for ribbon cables and special round cables. The required 24 V DC voltage supply must be input by the ribbon cable or the terminal points.</p>			
Nominal voltage	24 V DC (-15 %/+20 %)				24 V DC (-15 %/+20 %)				24 V DC (-15 %/+20 %)				24 V DC (-15 %/+20 %)			
Current consumption power contacts	typ. 2 mA + load				typ. 4 mA + load				only load				typ. 4 mA from the 24 V supply (no power contacts)			
Current consumpt. K-bus	typ. 5 mA				typ. 20 mA				typ. 8 mA				typ. 3 mA			
Operating temperature	0...+55 °C				0...+55 °C				0...+55 °C				0...+55 °C			
Approvals	CE, UL, Ex				CE, Ex				CE, UL, Ex				CE			
Weight	approx. 55 g				approx. 55 g				approx. 55 g				approx. 50 g			
Further information	www.beckhoff.com/KL1488				www.beckhoff.com/KL1889				www.beckhoff.com/KL1184				www.beckhoff.com/KL1862			
Special terminals													KL1862			
Distinguishing features													positive switching		521	

Digital input | 24 V DC, positive/negative switching

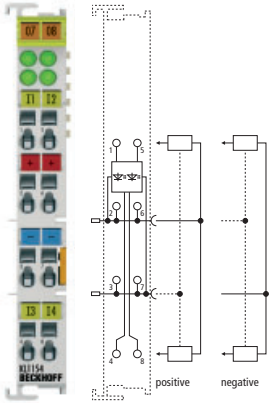
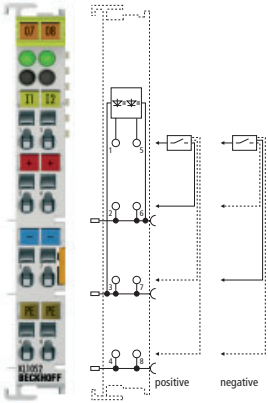
	4-channel digital input terminal, 24 V DC, 2-/3-wire		2-channel digital input terminal, 24 V DC, 4-wire
Technical data	KL1154 KS1154	KL1164 KS1164	KL1052 KS1052
Connection technology	2-/3-wire		4-wire
Specification	positive and negative switching		
Input filter	typ. 3.0 ms	typ. 0.2 ms	typ. 3.0 ms
Number of inputs	4		2
	 <p>Positive or negative switching sensors can be connected to the KL1154 and KL1164 digital input terminals.</p> <ul style="list-style-type: none"> – signal voltage "0": 7.6...17.4 V DC – signal voltage "1": 0...7 V DC and 18...30 V DC 		 <p>Positive or negative switching sensors can be connected to the KL1052 digital input terminal.</p> <ul style="list-style-type: none"> – signal voltage "0": 7.6...17.4 V DC – signal voltage "1": 0...7 V DC and 18...30 V DC
Nominal voltage	24 V DC (-15 %/+20 %)		24 V DC (-15 %/+20 %)
Current consumption power contacts	–		–
Current consumpt. K-bus	typ. 8 mA		typ. 8 mA
Operating temperature	0...+55 °C		0...+55 °C
Approvals	CE, UL, Ex		CE, UL, Ex
Weight	approx. 55 g		approx. 50 g
Further information	www.beckhoff.com/KL1154		www.beckhoff.com/KL1052
Special terminals			KL1052-0010
Distinguishing features			96 V DC (not in accordance with the EN 61131-2 specifications)

Digital input | 5...230 V

Rather than the usual 24 V DC control voltage, additional voltage range/potentials are implemented for sensors and actuators. The digital input terminals from the signal range 5...230 V allow direct input of these special sensor/actuator supplies without a further level conversion. The Bus Terminals are separately supplied with the corresponding control voltage by a power feed terminal, so that a Bus Terminal station can be operated with various different potential groups.

KL9xxx power feed terminals
see page [594](#)

4-channel digital
input terminal,
5 V DC,
2-/3-wire

2-channel digital
input terminal,
48 V DC,
4-wire, type 1

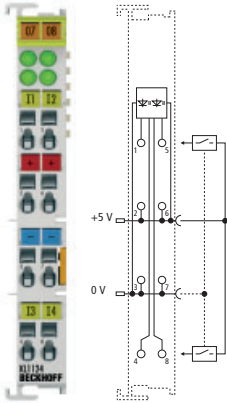
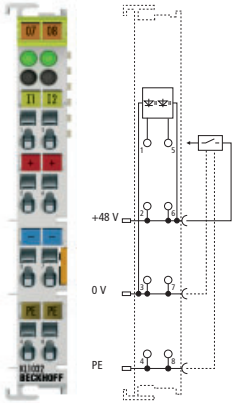
Technical data	KL1124 KS1124	KL1032 KS1032
Connection technology	2-/3-wire	4-wire
Signal voltage logic "0"	CMOS (< 0,8 V)	-6...+34 V
Signal voltage logic "1"	CMOS (> 2,4 V)	34...60 V
Input filter	typ. 0.2 ms	typ. 3.0 ms
Number of inputs	4	2
	 <p>The KL1124 digital input terminal is suitable for the reading of 5 V DC logic signals. The 5 V DC supply voltage can be generated with the KL9505 power supply unit terminal and fed in via the power contacts.</p>	 <p>The KL1032 digital input terminal is suitable for the reading of 48 V DC logic signals.</p>
Nominal voltage	5 V DC	48 V DC (-15 %/+20 %)
Current consumption power contacts	typ. 1 mA + load	–
Current consumpt. K-bus	typ. 5 mA	typ. 3 mA
Electrical isolation	500 V (K-bus/field potential)	500 V (K-bus/field potential)
Special features	supply 5 V DC via power contacts	further voltage values on request
Operating temperature	0...+55 °C	0...+55 °C
Approvals	CE, UL, Ex	CE, UL, Ex
Weight	approx. 50 g	approx. 50 g
Further information	www.beckhoff.com/KL1124	www.beckhoff.com/KL1032
Special terminals		
Distinguishing features		

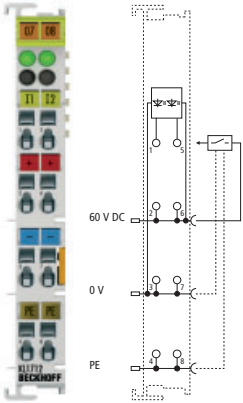
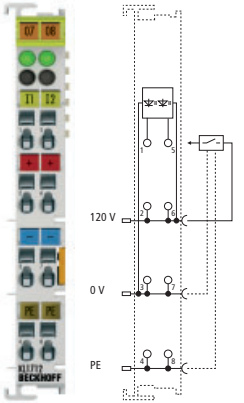
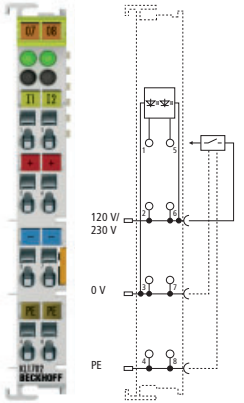
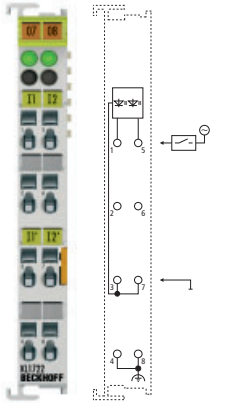
	2-channel digital input terminal, 60 V DC, 4-wire, type 1	2-channel digital input terminal, 120 V AC/DC, 4-wire, type 1	2-channel digital input terminal, 120 V AC/230 V AC, 4-wire, type 1	2-channel digital input terminal, 120 V AC/230 V AC, 2-wire, type 1
	KL1712-0060 KS1712-0060	KL1712	KL1702	KL1722
				2-wire
	0...20 V	0...40 V	0...40 V	0...40 V
	40...70 V	80...140 V	79...260 V	79...260 V
	typ. 10 ms	typ. 10 ms	typ. 10 ms	typ. 10 ms
	2	2	2	2
	 <p>The KL1712-0060 digital input terminal is suitable for the reading of 60 V DC logic signals.</p>	 <p>The KL1712 digital input terminal is suitable for the acquisition of direct and alternating voltage logic signals.</p>	 <p>The KL1702 digital input terminal is suitable for the acquisition of logic signals in the alternating voltage range from 120...230 V AC.</p>	 <p>The KL1722 digital input terminal does not have a power contact, so that individual potential groups can be built up. The voltage between input 1 and input 2 must not exceed 230 V AC.</p>
	60 V DC	120 V AC/DC	120 V AC/230 V AC	120 V AC/230 V AC
	–	–	–	–
	typ. 3 mA	typ. 3 mA	typ. 3 mA	typ. 3 mA
	500 V (K-bus/mains voltage); 3,750 V AC, 1 min.	500 V (K-bus/mains voltage); 3,750 V AC, 1 min.	500 V (K-bus/mains voltage); 3,750 V AC, 1 min.	500 V (K-bus/mains voltage); 3,750 V AC, 1 min.
	60 V DC rail applications	120 V AC power grids	ohmic/capacitive input behaviour	ohmic/capacitive input behaviour
	0...+55 °C	0...+55 °C	0...+55 °C	0...+55 °C
	CE	CE, UL	CE, UL	CE, UL
	approx. 60 g	approx. 60 g	approx. 60 g	approx. 60 g
	www.beckhoff.com/KL1712	www.beckhoff.com/KL1712	www.beckhoff.com/KL1702	www.beckhoff.com/KL1722
		KL1712-0010	KL1702-0010	
		24 V AC/DC input circuit	230 V AC input circuit with type 2 characteristics	

Digital input | 24 V DC, terminal modules

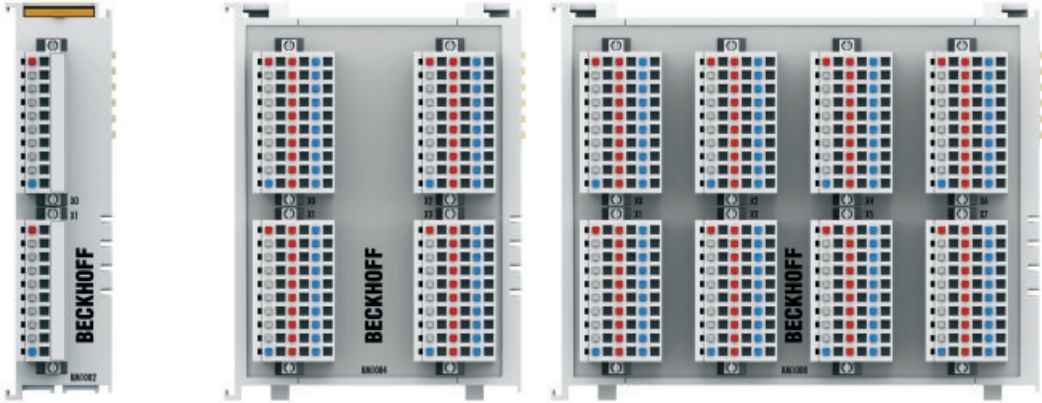
	16-channel digital input module, 24 V DC, plug connector, type 1		32-channel digital input module, 24 V DC, plug connector, type 1		64-channel digital input module, 24 V DC, plug connector, type 1	
Technical data	KM1002	KM1012	KM1004	KM1014	KM1008	KM1018
Connection technology	plug					
Specification	EN 61131-2, type 1					
Input filter	typ. 3.0 ms	typ. 0.2 ms	typ. 3.0 ms	typ. 0.2 ms	typ. 3.0 ms	typ. 0.2 ms
Number of inputs	16 (2 x 8)		32 (4 x 8)		64 (8 x 8)	
						
	<p>Like the standard Bus Terminals, the terminal modules are integrated in the I/O system. Plug connectors with spring connections enable plug-in wiring and are optionally available with 1 or 3 pins. LEDs integrated in the plug indicate the signal state for each channel directly at the wire.</p> <p>Ordering information:</p> <ul style="list-style-type: none"> KM10xx-0000 without plugs -0001 1-pin plug (without status LED) -0002 1-pin plug (with status LED) -0004 3-pin plug (with status LED) 					
Nominal voltage	24 V DC (-15 %/+20 %)		24 V DC (-15 %/+20 %)		24 V DC (-15 %/+20 %)	
Current consumption power contacts	– (no power contacts)		– (no power contacts)		– (no power contacts)	
Current consumpt. K-bus	typ. 3 mA		typ. 3 mA		typ. 3 mA	
Operating temperature	0...+55 °C		0...+55 °C		0...+55 °C	
Approvals	CE		CE		CE	
Weight	approx. 90 g with 1-pin connector, approx. 110 g with 3-pin connector		approx. 90 g with 1-pin connector, approx. 110 g with 3-pin connector		approx. 310 g with 1-pin connector, approx. 390 g with 3-pin connector	
Further information	www.beckhoff.com/KM1002		www.beckhoff.com/KM1004		www.beckhoff.com/KM1008	
Special terminals	KM10x2-000x		KM10x4-000x		KM10x8-000x	
Distinguishing features	different connectors		different connectors		different connectors	

Digital input | Manual operation

Manual input of process data directly to the terminal is suitable for example for:

- training and test installations
- emergency operating levels in buildings
- operating levels in the control cabinet
- program development/simulation

It is possible to have a response directly on the module by the LEDs controlled by the process image.

Together with the following terminals, further manual operational functions can be implemented:

- **KL2641**: 1-channel relay output terminal, 230 V AC, 16 A, bistable, manual operation
- **KM2642, KM2652**: 2-channel relay module, 230 V AC, 6 A, manual/automatic operation
- **KM2614**: 4-channel relay module, 230 V AC, 16 A, automatic operation/manual operation on the relay
- **KM4602**: 2-channel analog output terminal, 0...10 V, manual/automatic operation

4-channel manual operation,
4 x switch, 4 x LED

Technical data	KM1644
Specification	manual operation level
Number of inputs	4 inputs + 4 outputs
	
	<p>The digital KM1644 input terminal is used for manual input directly in the process data. The four switches supply their status to the control system as digital bit information. The four LEDs indicate the four output bits from the process data and cannot be activated directly via the switches.</p>
Nominal voltage	–
Current consumption power contacts	– (no power contacts)
Current consumpt. K-bus	typ. 5 mA
Switch settings	ON, OFF, PUSH
Special features	manual/emergency operation
Operating temperature	0...+55 °C
Approvals	CE
Weight	approx. 65 g
Further information	www.beckhoff.com/KM1644

Digital input | Special functions

A specific alignment of the logic signals to the application is possible with the special terminals. The signal is either pre-processed inside the terminal or prepared as far as possible by a specialised input circuit, so that no additional module needs to be switched between sensor and Bus Terminal.

The KL1362, KL1382 and KL1352 Bus Terminals generate a voltage internally for sensor supply. Depending on the logical state of the sensor this changes the current or the voltage. The Bus Terminal evaluates this state and transmits it to the process image of the controller. If required, a diagnostic for wiring breaks and short-circuits is available in the event of a fault.

2-channel digital input terminal, 24 V DC, with edge triggered pulse expansion

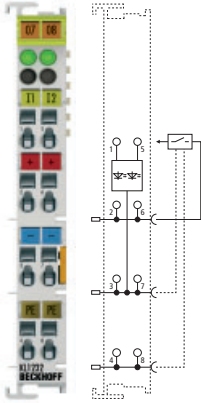
Technical data	KL1232 KS1232
Connection technology	4-wire
Specification	pulse expansion
Input filter	0.2 ms
Number of inputs	2
	
	<p>The KL1232 has an input circuit that extends plus-switched signals, triggered on the rising edge, to 100 ms. The KL1232 is particularly suitable for recording very short signals in control systems with a longer processing time than the signal length.</p>
Nominal voltage	24 V DC (-15 %/+20 %)
"0" signal voltage	-3...+5 V
"1" signal voltage	15...30 V
Current consumption power contacts	–
Current consumpt. K-bus	typ. 5 mA
Special features	edge triggered pulse expansion
Operating temperature	0...+55 °C
Approvals	CE, UL, Ex
Weight	approx. 55 g
Further information	www.beckhoff.com/KL1232
Special terminals	KL1232-xxxx
Distinguishing features	special terminals see page 605

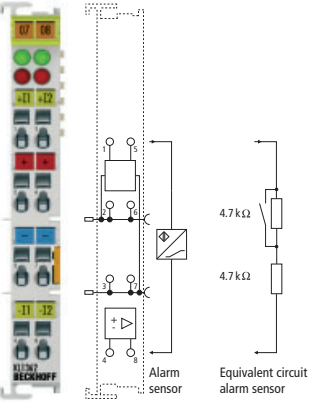
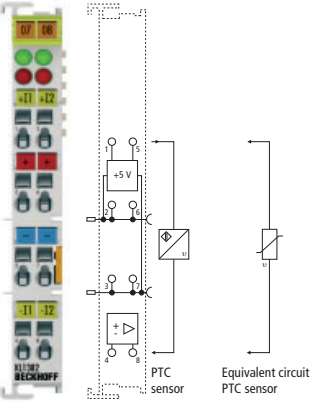
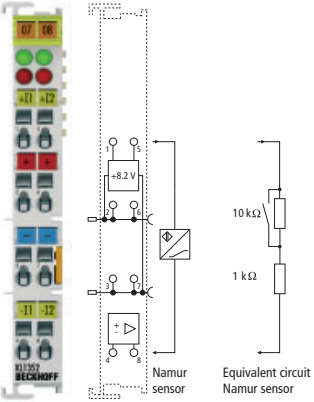
<p>2-channel digital input terminal, 24 V DC, for break-in alarm</p>	<p>2-channel digital input terminal, 24 V DC, thermistor</p>	<p>2-channel digital input terminal, 24 V DC, for Namur sensors</p>
<p>KL1362 KS1362 KL1382 KS1382 KL1352 KS1352</p>		
<p>2-wire</p>		
<p>break-in alarm</p>	<p>thermistor PTC</p>	<p>Namur</p>
<p>3.0 ms</p>	<p>30 ms</p>	<p>3.0 ms</p>
<p>2</p>	<p>2</p>	<p>2</p>
<div style="display: flex; align-items: center;">  </div> <p>The digital KL1362 input terminal analyses the input signals of break-in sensors with the aid of a current loop. It enables safe monitoring of alarm contacts with fixed resistance ratio. In the process image, the state of the sensor is indicated by one bit each. A further bit reports short circuits or line interruptions.</p> <ul style="list-style-type: none"> - line interruption: < 0.1 mA - short circuit: > 3 mA - cable resistance: ≤ 200 Ω 	<div style="display: flex; align-items: center;">  </div> <p>The digital KL1382 input terminal analyses the input signal of thermistor sensors with the aid of a current loop and a voltage of less than 5 V. It is a monitoring device for the thermal machine protection of PTC sensors, suitable for the direct monitoring of motors, bearings and equipment. In the process image, the state of the sensor is indicated by one bit each. A further bit reports short circuits or line interruptions.</p> <ul style="list-style-type: none"> - sensor voltage: ≤ 5 V - diagnostics: open-circuit: > 8 kΩ short-circuit: < 25 Ω 	<div style="display: flex; align-items: center;">  </div> <p>The digital input terminal KL1352 analyses the input signal from Namur sensors in accordance with EN 50277 (previously DIN 19234). One bit indicates the sensor's signal state in the process image. A further bit reports short circuits or line interruptions.</p> <ul style="list-style-type: none"> - switching hysteresis: 0.2 mA - short circuit current: < 8.2 mA - short circuit detection: > 6.5 mA
<p>24 V (-15 %/+20 %)</p>	<p>24 V (-15 %/+20 %)</p>	<p>24 V (-15 %/+20 %)</p>
<p>< 1 mA</p>	<p>≤ 1.5 kΩ</p>	<p>≤ 1.2 mA</p>
<p>> 1 mA</p>	<p>≥ 3 kΩ</p>	<p>≥ 2.1 mA</p>
<p>-</p>	<p>-</p>	<p>-</p>
<p>typ. 35 mA</p>	<p>typ. 60 mA</p>	<p>typ. 70 mA</p>
<p>monitoring of alarm contacts</p>	<p>monitoring device for thermal machine protection</p>	<p>Namur</p>
<p>0...+55 °C</p>	<p>0...+55 °C</p>	<p>0...+55 °C</p>
<p>CE, UL, Ex, GL</p>	<p>CE, UL, Ex, GL</p>	<p>CE, UL, Ex, GL</p>
<p>approx. 55 g</p>	<p>approx. 55 g</p>	<p>approx. 55 g</p>
<p>www.beckhoff.com/KL1362</p>	<p>www.beckhoff.com/KL1382</p>	<p>www.beckhoff.com/KL1352</p>

Digital input | Counter

Pulses often need to be captured in technical control applications. If the pulse length is the order of magnitude of the control cycle time or less, the controller cannot record these signals correctly any more. Pre-processing is then required. The "counter terminals" can count the number of pulses and deliver reliable values to the controller, even though the controller cannot capture the pulse at that speed. The counter is adapted to the individual requirements, such as forwards/backwards counter or Gate/Latch-controlled, by parameterisation. With a counter depth of 16- or 32-bit an overflow, even at high frequencies, can easily be managed by the controller.

The KL1501 is optimised for particularly fast signals. On this basis, other input voltages and special pre-processing are available with special varieties of terminals. The KL1512 is developed for price-sensitive areas of application and has certain limitations in relation to speed, bit width and functionality.

Up/down counter,
24 V DC, 100 kHz, 32 bit

Up/down counter,
24 V DC, 1 kHz, 16 bit

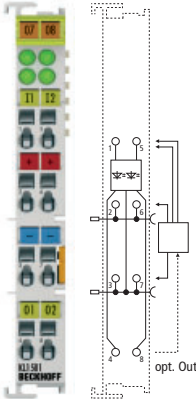
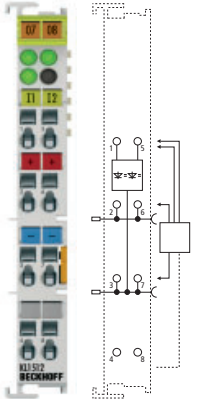
Technical data	KL1501 KS1501	KL1512 KS1512
Input filter	–	0.2 ms
Number of inputs	2	
	 <p>The up/down counter counts binary pulses, and transmits the counter state, in an electrically isolated form, to the higher-level automation device. In the KL1501 Bus Terminal it is possible to choose the (32-bit) counting direction (forwards/backwards) using the forwards/backwards input, and the gate connection can be used to trigger the counter.</p>	 <p>In the KL1512 digital input terminal it is possible to choose forwards or backwards counter (16-bit) direction. It is particularly suitable for simple counting tasks.</p>
Nominal voltage	24 V DC (-15 %/+20 %)	24 V DC (-15 %/+20 %)
"0" signal voltage	-3...+5 V	-3...+5 V
"1" signal voltage	15...30 V	15...30 V
Current consum. pow.cont.	–	–
Current consumpt. K-bus	typ. 50 mA	typ. 50 mA
Counting frequency	max. 100 kHz (2 kHz for switching up and down)	max. 1 kHz
Max. output current	0.5 A typ. (short-circuit-proof) per channel	–
Counter depth	32 bits	16 bits
Special features	2 additional outputs	–
Operating temperature	0...+55 °C	0...+55 °C
Approvals	CE, UL, Ex	CE, Ex
Weight	approx. 50 g	approx. 55 g
Further information	www.beckhoff.com/KL1501	www.beckhoff.com/KL1512
Special terminals	KL1501-0010	
Distinguishing features	special terminal see	605

Digital input | TwinSAFE

The KL1904 safety Bus Terminal is a digital input terminal for sensors with potential-free 24 V DC contacts and comprises four fail-safe inputs. The KL1904 meets the requirements of IEC 61508 SIL 3 and DIN EN ISO 13849-1:2008 PL_e.

For further information on TwinSAFE and the TwinSAFE products see page **828**

4-channel digital input terminal, TwinSAFE, 24 V DC

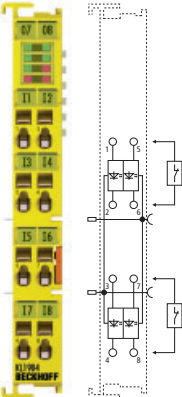
Technical data	KL1904
Connection technology	2-wire
Safety standard	IEC 61508 SIL 3 and DIN EN ISO 13849-1:2008 PL _e
Number of inputs	4
	 <p>The KL1904 Safety Bus Terminal has four fail-safe inputs.</p>
Protocol	TwinSAFE/FSoE
Nominal voltage	24 V DC (-15 %/+20 %)
Current consumption power contacts	–
Current consumpt. K-bus	48 mA
Response time	typ. 4 ms (read input/write to K-bus)
Fault response time	≤ watchdog time (parameterisable)
Permiss. degree of contamination	2
Climate class EN60721-3-3	3K3
Installation position	horizontal
Special features	4 safe inputs
Operating temperature	0...+55 °C
Approvals	CE, UL, Ex, TÜV Süd
Weight	approx. 50 g
Protection class	IP 20
Further information	www.beckhoff.com/KL1904

Digital output | 24 V DC, positive switching

Many actuators are driven or controlled with 24 V DC. The Bus Terminals of the "positive switching" category switch all output channels to 24 V DC, so all connected actuators are hard-wired to ground (0 V). The output of a Bus Terminal can be considered as a functional 24 V DC relay contact. The output circuit offers further functions such as short-circuit-current limitation, short-circuit switch-off and the rapid depletion of inductive energy from the coil.

The most common output circuit delivers a maximum continuous current of 0.5 A. Special output terminals are available for higher currents. Any type of load (ohmic, capacitive, inductive) can be connected to an output terminal. As lamp and capacitive loads are critical due to their high starting currents, they are limited by the output circuits of the Bus Terminals. This ensures that the upstream circuit-breaker is not triggered. Inductive loads are problematic at switch-off, as high induction voltages develop if the current is interrupted too fast. An integrated freewheeling diode prevents this voltage peak. However, the current is reduced so slowly that it leads to faults in many technical control applications.

For example, a valve remains open for many milliseconds. The Bus Terminals represent a compromise between prevention of overvoltage and rapid switch-off. They suppress the induction voltage to about 24 V DC and realise switch-off times which approximately correspond to the switch-on time of the coil.

In the case of short-circuit, the output circuit limits the current and prevents the activation of the upstream circuit-breaker. The Bus Terminal maintains this current until important self-heating and finally switches off. After the circuit has cooled, it switches back on. The output signal is driven in time until the output of the controller is switched off or the short-circuit is rectified. The clock frequency depends on the ambient temperature and the load of the other terminal channels. The overload protection of the output is also realised by thermal switch-off. The total current specified should be observed. If a total current is not given, it is not limited.

8-channel digital output terminal, 24 V DC, 1-wire

Technical data	KL2408 KS2408
Connection technology	1-wire
Load type	ohmic, inductive, lamp load
Max. output current	0.5 A (short-circuit-proof) per channel
Number of outputs	8

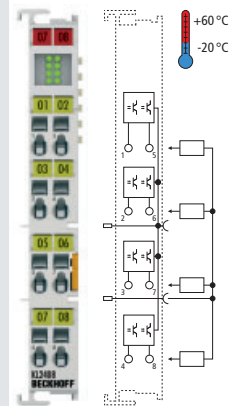

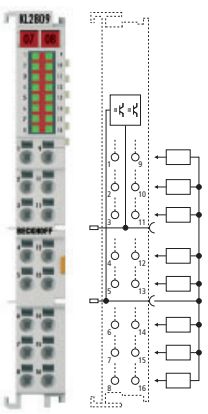
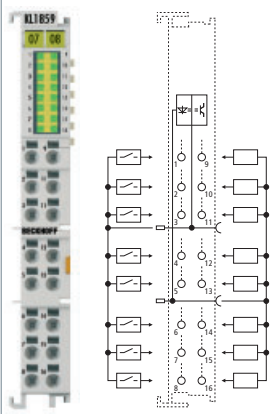
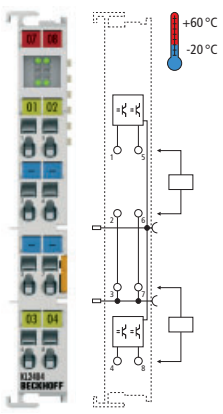
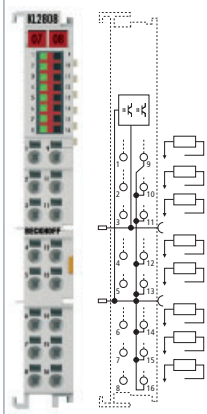

The KL2408 digital output terminal has 8 outputs, each one is assigned a terminal point. This way, a high packing density can be achieved for actuators with common ground potential.

Nominal voltage	24 V DC (-15 %/+20 %)
Current consumption power contacts	typ. 60 mA + load
Current consumpt. K-bus	typ. 18 mA
Breaking energy	< 150 mJ/channel
Reverse voltage protection	yes
Short circuit current	< 2 A
Operating temperature	-20...+60 °C
Approvals	CE, UL, Ex, GL
Weight	approx. 70 g
Further information	www.beckhoff.com/KL2408

	16-channel digital output terminal, 24 V DC, 1-wire	8-channel digital input + 8-channel digital output, 24 V DC, 1-wire	4-channel digital output terminal, 24 V DC, 2-wire	8-channel digital output terminal, 24 V DC, 2-wire
	KL2809	KL1859	KL2404 KS2404	KL2424 KS2424
			2-wire	
	0.5 A (short-circuit-proof) per channel		0.5 A (short-circuit-proof) per channel	2.0 A (short-circuit-proof) per channel
	16	8 outputs + 8 inputs	4	8
	 <p>The KL2809 HD (High Density) Bus Terminal has 16 digital outputs and is suitable for applications in which a very high packing density is required.</p>	 <p>The KL1859 digital Bus Terminal combines eight digital inputs and eight digital outputs in one device.</p> <ul style="list-style-type: none"> – number of inputs: 8 – input filter: 3.0 ms – type 1/3 	 <p>The KL2404 and KL2424 digital input terminals are suitable for the connection of four 2-wire actuators.</p>	 <p>The KL2808 High Density Bus Terminal contains eight outputs and eight ground connection points for the connection of 2-wire actuators and thus allows a very high packing density.</p>
	24 V DC (-15 %/+20 %)	24 V DC (-15 %/+20 %)	24 V DC (-15 %/+20 %)	24 V DC (-15 %/+20 %)
	typ. 35 mA + load	typ. 15 mA + load	typ. 30 mA + load	typ. 15 mA + load
	typ. 35 mA	typ. 25 mA	typ. 9 mA	typ. 20 mA
	< 150 mJ/channel	< 150 mJ/channel	< 150 mJ/channel	< 150 mJ/channel
	yes	yes	yes	yes
	< 2 A	< 2 A	< 2 A	< 2 A
	0...+55 °C	0...+55 °C	-20...+60 °C	0...+55 °C
	CE, Ex	CE, Ex	CE, UL, Ex	CE, Ex
	approx. 70 g	approx. 60 g	approx. 70 g	approx. 65 g
	www.beckhoff.com/KL2809	www.beckhoff.com/KL1859	www.beckhoff.com/KL2404	www.beckhoff.com/KL2808

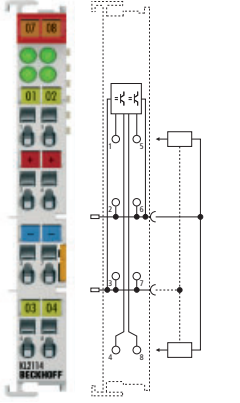
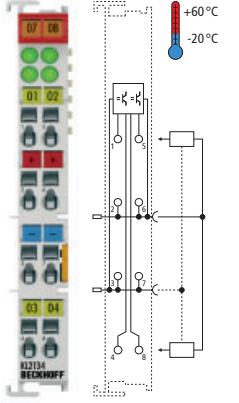
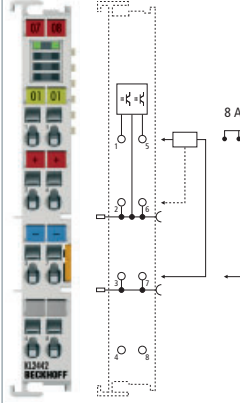
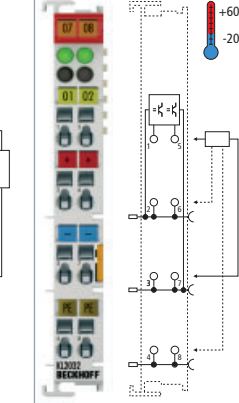
Digital output | 24 V DC, positive switching

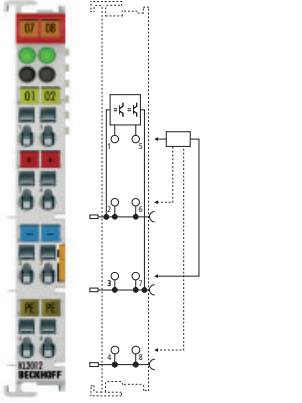
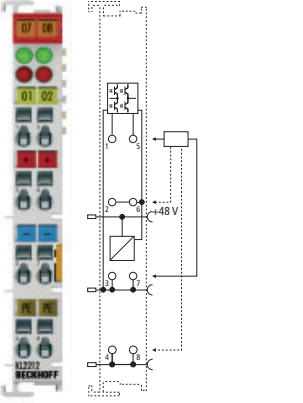
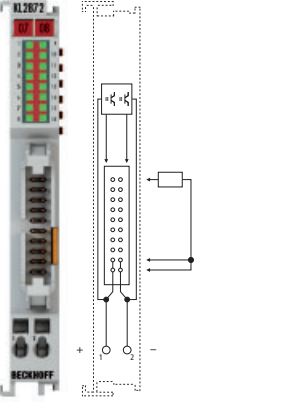
	4-channel digital output terminal, 24 V DC, 2-/3-wire	4-channel digital output terminal, 24 V DC, 2-/3-wire	2-channel digital output terminal, 24 V DC, 3-wire	2-channel digital output terminal, 24 V DC, 4-wire
Technical data	KL2114 KS2114	KL2134 KS2134	KL2442	KL2032
Connection technology	2-/3-wire		3-wire	4-wire
Load type	ohmic, inductive, lamp load			
Max. output current	0.5 A (short-circuit-proof) per channel	0.5 A (short-circuit-proof) per channel	4.0 A (short-circuit-proof) per channel, 8 A for parallel connection	0.5 A (short-circuit-proof) per channel
Number of outputs	4	4	2	2
	 <p>The KL2114 digital output terminal connects the control signals to the actuators in an electrically isolated manner.</p>	 <p>The KL2134 digital output terminal connects the control signals to the actuators in an electrically isolated manner.</p>	 <p>The KL2442 is suitable for the connection of actuators with high current requirement of 4 A. For parallel switched outputs, even 8 A is possible.</p>	 <p>The KL2032 digital output terminal connects the control signals to the actuators in an electrically isolated manner.</p>
Nominal voltage	24 V DC (-15 %/+20 %)	24 V DC (-15 %/+20 %)	24 V DC (-15 %/+20 %)	24 V DC (-15 %/+20 %)
Current consumption power contacts	typ. 30 mA + load	typ. 30 mA + load	typ. 30 mA + load	typ. 20 mA + load
Current consumpt. K-bus	typ. 9 mA	typ. 9 mA	typ. 9 mA	typ. 5 mA
Breaking energy	< 150 mJ/channel	< 150 mJ/channel	no data	< 150 mJ/channel
Reverse voltage protection	–	yes	yes	yes
Short circuit current	< 2 A	< 2 A	< 70 A	< 2 A
Operating temperature	0...+55 °C	-20...+60 °C	0...+55 °C	-20...+60 °C
Approvals	CE, UL, Ex	CE, UL, Ex, GL	CE	CE, UL, Ex, GL
Weight	approx. 70 g	approx. 70 g	approx. 70 g	approx. 55 g
Further information	www.beckhoff.com/KL2114	www.beckhoff.com/KL2134	www.beckhoff.com/KL2442	www.beckhoff.com/KL2032
Special terminals				
Distinguishing features				

2-channel digital output terminal, 24 V DC, 4-wire		2-channel digital output terminal, 24 V DC, 4-wire, with diagnostics		16-channel digital output terminal, 24 V DC, flat-ribbon cable connection		16-channel digital output terminal, 24 V DC, D-sub connection	
KL2012 KS2012		KL2022 KS2022		KL2212 KS2212		KL2872	
				flat-ribbon cable		D-sub	
0.5 A (short-circuit-proof) per channel		2.0 A (short-circuit-proof) per channel		0.5 A (short-circuit-proof) per channel		0.5 A (short-circuit-proof) per channel	
2		2		16		16	
 <p>The digital output terminals KL2012 and KL2022 connect the control signals to the actuators in an electrically isolated manner.</p>		 <p>Diagnostic possibilities:</p> <ul style="list-style-type: none"> – short-circuit to 24 V – short-circuit to 0 V – undervoltage 		 <p>The KL2872 allows the connection of 16 actuators by direct ribbon cable via a 20-pin contact strip with a 2.54 mm contact spacing. The required 24 V DC voltage supply must be input by the ribbon cable or the terminal points.</p>		 <p>The digital output terminal KM2042 allows direct connection of actuators by D-sub connection, which is common in e.g. valve terminals.</p>	
24 V DC (-15 %/+20 %)		24 V DC (-15 %/+20 %)		24 V DC (-15 %/+20 %)		24 V DC (-15 %/+20 %)	
typ. 15 mA + load		typ. 20 mA + load		typ. 15 mA + load		typ. 60 mA from the supply (no power contacts)	
typ. 5 mA		typ. 15 mA		typ. 15 mA		typ. 5 mA	
< 150 mJ/channel		< 1.7 J/channel		< 150 mJ/channel		< 150 mJ/channel	
–		–		yes		yes	
< 2 A		< 70 A		< 2 A		< 2 A	
0...+55 °C		0...+55 °C		0...+55 °C		0...+55 °C	
CE, UL, Ex		CE, UL, Ex, GL		CE, UL, Ex		CE	
approx. 55 g		approx. 60 g		approx. 55 g		approx. 90 g	
www.beckhoff.com/KL2012		www.beckhoff.com/KL2212		www.beckhoff.com/KL2872		www.beckhoff.com/KM2042	
				KL2872-0010			
				negative switching		538	

Digital output | 24 V DC, terminal modules

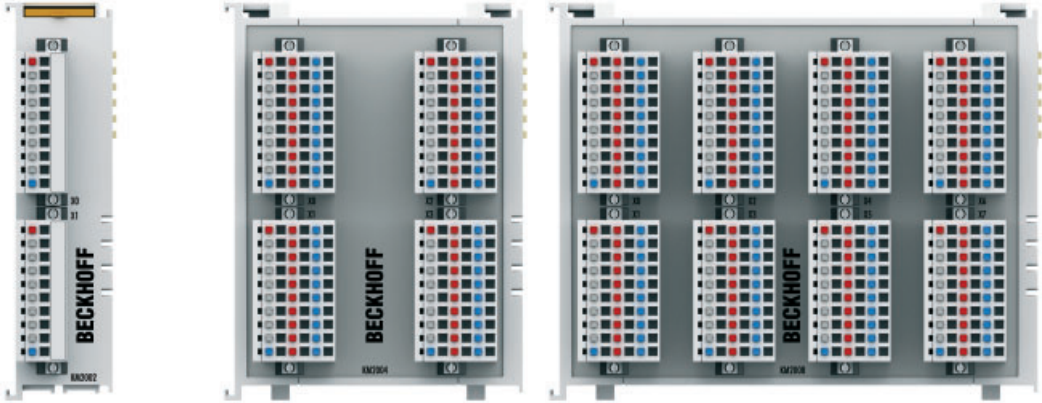
	16-channel digital output, 24 V DC, plug connector	32-channel digital output, 24 V DC, plug connector	64-channel digital output, 24 V DC, plug connector
Technical data	KM2002	KM2004	KM2008
Connection technology	plug		
Load type	ohmic, inductive, lamp load		
Max. output current	0.5 A (short-circuit-proof) per channel	0.5 A (short-circuit-proof) per channel	0.5 A (short-circuit-proof) per channel
Number of outputs	16 (2 x 8)	32 (4 x 8)	64 (8 x 8)
			
	<p>Like the standard Bus Terminals, the terminal modules are integrated in the I/O system. Plug connectors with spring connections enable plug-in wiring and are optionally available with 1 or 3 pins. LEDs integrated in the plug indicate the signal state for each channel directly at the wire.</p> <p>Ordering information:</p> <p>KM200x-0000 without plugs -0001 1-pin plug (without status LED) -0002 1-pin plug (with status LED) -0004 3-pin plug (with status LED)</p>		
Nominal voltage	24 V DC (-15 %/+20 %)	24 V DC (-15 %/+20 %)	24 V DC (-15 %/+20 %)
Current consumption power contacts	– (no power contacts)	– (no power contacts)	– (no power contacts)
Current consumpt. K-bus	typ. 5 mA	typ. 5 mA	typ. 5 mA
Breaking energy	< 150 mJ/channel	< 150 mJ/channel	< 150 mJ/channel
Reverse voltage protection	yes	yes	yes
Short circuit current	< 2 A	< 2 A	< 2 A
Operating temperature	0...+55 °C	0...+55 °C	0...+55 °C
Approvals	CE	CE	CE
Weight	approx. 90 g with 1-pin connector, approx. 110 g with 3-pin connector	approx. 90 g with 1-pin connector, approx. 110 g with 3-pin connector	approx. 310 g with 1-pin connector, approx. 390 g with 3-pin connector
Further information	www.beckhoff.com/KM2002	www.beckhoff.com/KM2004	www.beckhoff.com/KM2008
Special terminals	KM2002-000x	KM2004-000x	KM2008-000x
Distinguishing features	different connectors	different connectors	different connectors

Digital output | TwinSAFE; 5 V DC, positive switching

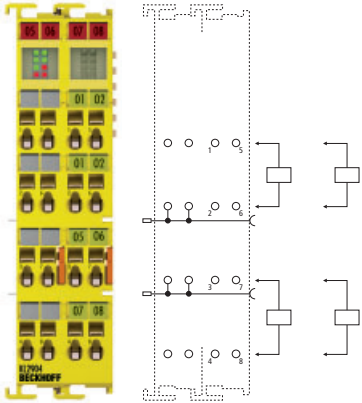
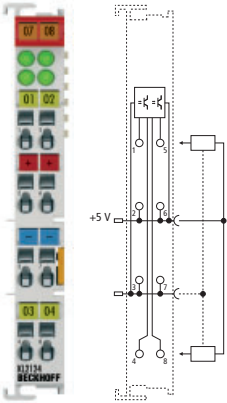
	4-channel digital output terminal, TwinSAFE, 24 V DC	4-channel digital output terminal, 5 V DC, 2-/3-wire
Technical data	KL2904	KL2124 KS2124
Connection technology	2-wire	2-/3-wire
Safety standard	IEC 61508 SIL 3 and DIN EN ISO 13849-1:2008 PL _e	–
Max. output current	0.5 A/20 mA min. (per channel)	±20 mA (short-circuit-proof) per channel, 8 mA signal current
Number of outputs	4	4
	 <p>The KL2904 Safety Bus Terminal has four outputs.</p> <p>For further information on TwinSAFE and the TwinSAFE products see page 828</p>	 <p>The positive-switching KL2124 output terminal offers four outputs and additionally provides 5 V DC and ground (0 V) for each channel.</p>
Nominal voltage	24 V DC (-15 %/+20 %)	5 V DC
Current consumption power contacts	load-dependent	typ. 16 mA + load
Current consumpt. K-bus	250 mA	typ. 14 mA
Protocol	TwinSAFE/FS _o E	–
Fault response time	≤ watchdog time (parameterisable)	–
Installation position	horizontal	variable
Special features	4 safe outputs	–
Operating temperature	0...+55 °C	0...+55 °C
Approvals	CE, UL, Ex, TÜV Süd	CE, Ex
Weight	approx. 100 g	approx. 70 g
Further information	www.beckhoff.com/KL2904	www.beckhoff.com/KL2124

Digital output | 24 V DC, negative switching

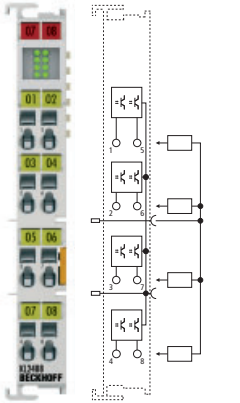
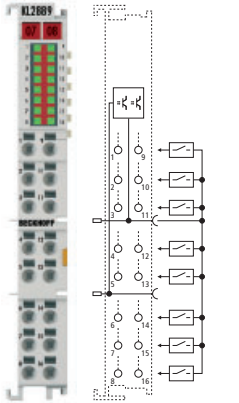
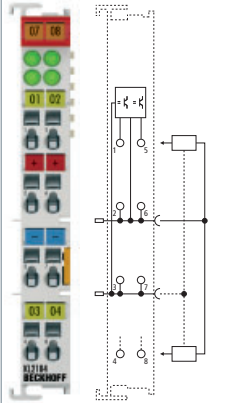
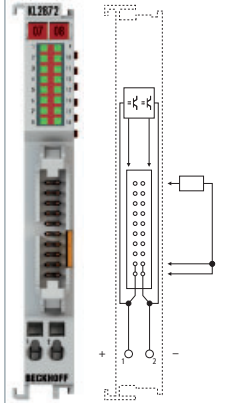
	8-channel digital output terminal, 24 V DC, 1-wire	16-channel digital output terminal, 24 V DC, 1-wire	4-channel digital output terminal, 24 V DC, 2-/3-wire	16-channel digital output terminal, 24 V DC, flat-ribbon cable connection
Technical data	KL2488 KS2488	KL2889	KL2184 KS2184	KL2872-0010
Connection technology	1-wire		2-/3-wire	flat-ribbon cable
Load type	ohmic, inductive, lamp load			
Max. output current	0.5 A (short-circuit-proof) per channel	0.5 A (short-circuit-proof) per channel	0.5 A (short-circuit-proof) per channel	0.5 A (short-circuit-proof) per channel
Number of outputs	8	16	4	16
	 <p>The KL2488 digital output terminal is suitable for the connection of eight negative switching actuators using 1-wire connection technology.</p>	 <p>The KL2889 HD (High Density) Bus Terminal offers terminal points for 16 negative switching actuators using 1-wire connection technology and thus a very high packing density.</p>	 <p>The KL2184 digital output terminal offers four outputs and additionally provides 24 V DC and ground (0 V) for each channel.</p>	 <p>A 20-pin plug connector with 2.54 mm contact spacing enables the secure connection of plug connectors using insulation displacement contact, as is usual for ribbon cables and special round cables. The required 24 V DC voltage supply must be input by the ribbon cable or the terminal points 1 and 2.</p>
Nominal voltage	24 V DC (-15 %/+20 %)	24 V DC (-15 %/+20 %)	24 V DC (-15 %/+20 %)	24 V DC (-15 %/+20 %)
Current consumption power contacts	typ. 60 mA + load	typ. 35 mA + load	typ. 30 mA + load	typ. 60 mA from the supply (no power contacts)
Current consumpt. K-bus	typ. 18 mA	typ. 45 mA	typ. 9 mA	typ. 5 mA
Breaking energy	< 100 mJ/channel	< 100 mJ/channel	< 100 mJ/channel	< 100 mJ/channel
Reverse voltage protection	yes	yes	yes	yes
Short circuit current	< 7 A	< 7 A	< 7 A	< 7 A
Operating temperature	0...+55 °C	0...+55 °C	0...+55 °C	0...+55 °C
Approvals	CE, UL, Ex	CE, Ex	CE, UL, Ex	CE
Weight	approx. 70 g	approx. 70 g	approx. 70 g	approx. 55 g
Further information	www.beckhoff.com/KL2488	www.beckhoff.com/KL2889	www.beckhoff.com/KL2184	www.beckhoff.com/KL2872

Digital output | 24 V AC/DC, solid state relays

The KL2784 and KL2794 digital output terminals each provide four switches, which can be used like a relay contact for AC/DC voltages. The KL2784 uses a power contact as a common potential. In the KL2794, the power contacts are passed directly to the circuit without connection.

The electronic switch in the Bus Terminal is implemented by efficient Mosfet transistors with a low switch-on resistance. The electronics are virtually wear-free. The switch itself is not short-circuit-proof, but can conduct a high current with its high pulse current capability long enough, until the circuit-breaker switches off. It behaves like a robust relay contact.

Inductive loads can be switched directly, without further safety measures. The circuit switches relatively slowly and prevents high peak voltages. No break sparks are created in the terminal and thus no electromagnetic interference pulse.

4-channel digital output terminal, 24 V AC/DC, solid state relay

4-channel digital output terminal, 24 V AC/DC, solid state relay, potential-free

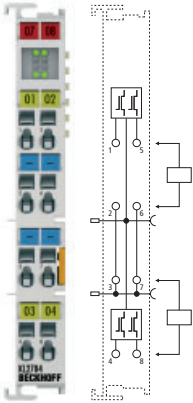
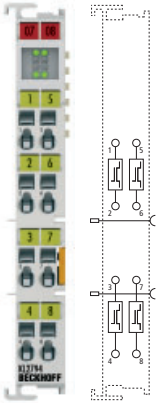
Technical data	KL2784 KS2784	KL2794 KS2794
Connection technology	2-wire	
Load type	AC/DC loads	
Max. output current	2 A	2 A
Number of outputs	4 x make contacts	4 x make contacts
	 <p>4 electronic switches on the power contact</p>	 <p>4 potential-free electronic switches</p>
Nominal voltage	0...24 V AC/DC	0...24 V AC/DC
Switching on speed	typ. 1.8 ms, max. 5 ms	typ. 1.8 ms, max. 5 ms
Switching off speed	typ. 30 ms, max. 50 ms	typ. 30 ms, max. 50 ms
Current consumption power contacts	only load	–
Current consumpt. K-bus	80 mA	80 mA
Breaking energy	no data	no data
Short circuit current	90 A	90 A
Surge voltage protection	> 39 V	> 39 V
Peak current	5 A (100 ms), < 50 A (10 ms)	5 A (100 ms), < 50 A (10 ms)
Closing resistor	typ. 0.03 Ω	typ. 0.03 Ω
Special features	alternative for relay contacts	alternative for relay contacts, potential-free
Operating temperature	0...+55 °C	0...+55 °C
Approvals	CE, Ex	CE, Ex
Weight	approx. 70 g	approx. 70 g
Further information	www.beckhoff.com/KL2784	www.beckhoff.com/KL2794

Digital output | Relay outputs up to 400 V AC

The Bus Terminals switch a relay as a function of the bits in the process image. The relays completely isolate the current flow by a mechanical contact; there is no residual current through the open contact. The Bus Terminals are not equipped with a protective circuit, so as not to allow for residual current by parallel switched components. The relay contacts differ in their contact material. Signal contacts also switch small voltages and currents; large current here lead to a change in the contact characteristics. Power contacts can switch large loads. An oxide layer on the power contacts prevents safe contact for small voltages below 1 V DC.

Switching on is accompanied by a bouncing. The electrical connection is initially switched on and off briefly, until the contact is securely in its closed location. With an inductive load (coil) this behaviour leads to a spark and to corresponding electromagnetic radiation. Capacitive loads create a short-circuit for a brief period of time. This can – particularly with alternating voltages – lead to such high switch-on currents at switch-on under peak value that the bouncing contact is burned shut. A capacitive load can also be electronic devices, which are typically equipped with a rectifier in the input and a relatively large smoothing capacitor. Electronic ballast is especially critical for fluorescent lamps. The maximum switch-on currents of the devices, which should be observed, are shown in the technical data numerous times.

The switch-off of a relay takes place by mechanical opening the contact. An arc burns for a short moment and warms the contact. For an inductive load (coil) a large part of the magnetic energy stored in the coil is additionally released as heat at the contact. This load on the contact determines the service life of the relay and is called the electrical service life. The mechanical service life is defined as the number of switching operations without current flow through the contact.



2-channel relay output terminal, 125 V AC

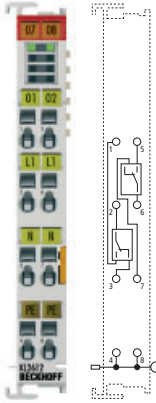
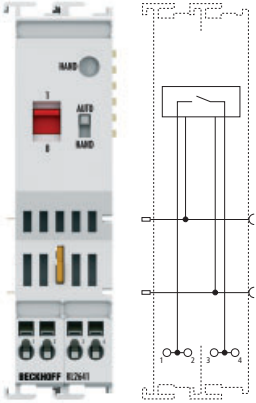

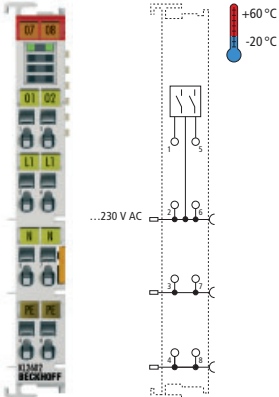
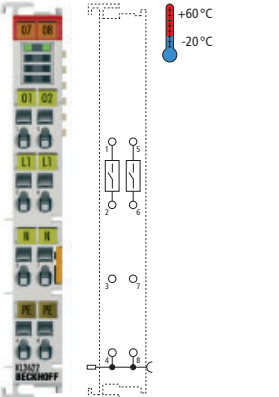
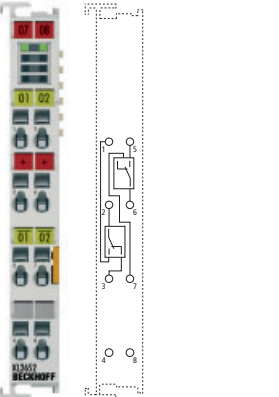
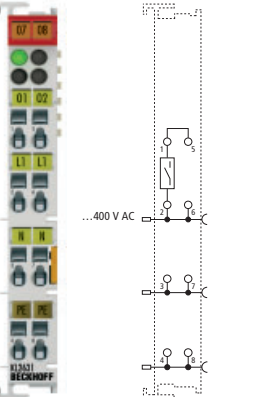
1-channel relay output terminal, 230 V AC, bistable, manual operation

Technical data	KL2612	KL2641
Load type	ohmic	ohmic, inductive, lamp load
Max. output current	2 A	16 A
Number of outputs	2 x change-over	1 make contact
	 <p>The KL2612 Bus Terminal is equipped with potential-free contacts.</p>	 <p>The KL2641 output terminal has a relay with a single contact, which can be used universally for the switching of mains voltage consumers. The relay can optionally be switched in manual or automatic mode.</p>
Nominal voltage	125 V AC/30 V DC	230 V AC (max. switching voltage 440 V AC)
Current consum. pow.cont.	– (no power contacts)	typ 65 mA + load
Current consumpt. K-bus	typ. 60 mA	typ. 5 mA
Switching current	0.5 A AC/2 A DC (ohmic)	16 A AC
Operat. cycles mech. (min.)	1 x 10 ⁸	1 x 10 ⁶
Operat. cycles electr. (min.)	2 x 10 ⁵ (1 A/30 V DC)	no data
Lamp test, electronic ballast	max. 2 A starting current	max. 16 A starting current
Minimum permitted load	10 µA at 10 mV	–
Special features	signal relay	manual operation; bistable relay contact
Operating temperature	0...+55 °C	0...+55 °C
Approvals	CE, UL, GL	CE
Weight	approx. 80 g	approx. 110 g
Further information	www.beckhoff.com/KL2612	www.beckhoff.com/KL2641

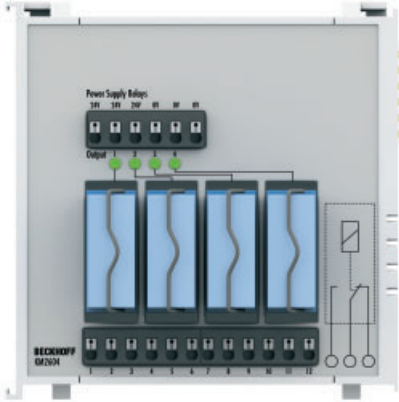
	2-channel relay output terminal, 230 V AC	2-channel relay output terminal, 230 V AC	2-channel relay output terminal, 230 V AC, 300 V DC	1-channel relay output terminal, 400 V AC, 300 V DC
	KL2602 KS2602	KL2622 KS2622	KL2652 KS2652	KL2631 KS2631
	5 A		2 A	
	2 x make contacts for power contact	2 x make contacts	2 x change-over	1 x make contacts for power contact
	 <p>The KL2602 output terminal has two relays each of which has a single contact. The relay contact is connected to the power contacts, which are suitable for use at up to 230 V AC, and can be generally used for switching devices requiring mains power.</p>	 <p>The KL2622 Bus Terminal has potential-free contacts; the power contacts are not looped through.</p>	 <p>The KL2652 output terminal has two relays each with a changeover contact, which can be used universally for the switching of mains voltage consumers of 230 V AC or 300 V DC. The KL2652 Bus Terminal is equipped with potential-free contacts.</p>	 <p>The KL2631 output terminal has a relay with a single contact, which is connected with the power contacts (usable up to 400 V AC) and can be used universally for the switching of mains voltage consumers. In order to use high voltages of up to 400 V AC, the KL2631 must be supplied via the KL9190 power feed terminal.</p>
	230 V AC/30 V DC	230 V AC/30 V DC	230 V AC (max. switching voltage 250 V AC/300 V DC)	400 V AC/300 V DC
	only load	–	– (no power contacts)	only load
	typ. 80 mA	typ. 85 mA	typ. 90 mA	typ. 80 mA
	5 A AC/DC (ohmic)/2 A AC/DC (inductive)	5 A AC/DC (ohmic)/2 A AC/DC (inductive)	max. 3 A AC/3 A DC at 30 V DC	switching capacity DC: 300 V = 0.15 A; 24 V = 5 A; non-linear; AC:1,500 VA
	2 x 10 ⁷	2 x 10 ⁷	5 x 10 ⁶	1 x 10 ⁷
	3 x 10 ⁵ (5 A/30 V DC)	3 x 10 ⁵ (5 A/30 V DC)	1 x 10 ⁶ (1 A/250 V AC)	1.3 x 10 ⁵ (2 A/250 V AC)
	max. 5 A starting current (4 x 58 W)	max. 5 A starting current (4 x 58 W)	max. 6 A starting current	no data
	10 mA at 5 V DC	10 mA at 5 V DC	100 mA (12 V DC)	no data
	power relay	potential-free contacts	reverse switching realisable	400 V contact
	-20...+60 °C	-20...+60 °C	0...+55 °C	0...+55 °C
	CE, UL, GL	CE, UL, GL	CE	CE, GL
	approx. 85 g	approx. 80 g	approx. 55 g	approx. 85 g
	www.beckhoff.com/KL2602	www.beckhoff.com/KL2622	www.beckhoff.com/KL2652	www.beckhoff.com/KL2631

Digital output | Relay outputs up to 400 V AC

	4-channel relay module, 230 V AC	4-channel relay module, 230 V AC, automatic/ manual operation
Technical data	KM2604	KM2614
Load type	ohmic, inductive, lamp load	
Max. output current	16 A	
Number of outputs	4 x change-over	4 x change-over
	 <p>The KM2604 terminal module combines four pluggable power relays in one fieldbus module. The high switching capacity of 16 A at 230 V AC enables direct mains connection of consumers with high current consumption. The relays are positioned at the top and can therefore be exchanged easily.</p>	 <p>The KM2614 terminal module combines four pluggable power relays in one fieldbus module. The high switching capacity of 16 A at 230 V AC enables direct mains connection of consumers with high current consumption. The relays are positioned at the top and can therefore be exchanged easily. Each relay can be manually switched to the ON status. A seal indicates the initial manual operation.</p>
Nominal voltage	230 V AC (max. switching voltage 250 V AC/30 V DC)	230 V AC (max. switching voltage 250 V AC/30 V DC)
Current consumption power contacts	– (no power contacts)	– (no power contacts)
Current consumpt. K-bus	typ. 15 mA	typ. 15 mA
Switching current	16 A AC/12 A DC at 30 V DC	16 A AC/12 A DC at 30 V DC
Operat. cycles mech. (min.)	5 x 10 ⁶	5 x 10 ⁶
Operat. cycles electr. (min.)	1 x 10 ⁶ (1 A/250 V AC)	1 x 10 ⁶ (1 A/250 V AC)
Lamp test, electronic ballast	max. 25 A starting current	max. 25 A starting current
Minimum permitted load	5 mA (10 V DC)	5 mA (10 V DC)
Special features	–	automatic/manual operation at the relay
Operating temperature	0...+55 °C	0...+55 °C
Approvals	CE	CE
Weight	approx. 250 g	approx. 250 g
Further information	www.beckhoff.com/KM2604	www.beckhoff.com/KM2614

<p>2-channel relay module, 230 V AC, manual/automatic operation</p>	<p>2-channel relay module, 230 V AC, manual/automatic operation</p>
<p>KM2642</p>	<p>KM2652</p>
<p>6 A</p>	
<p>2 x change-over</p>	<p>2 x change-over</p>
 <p>The digital KM2642 output terminal has two independent relay change-over contacts, which can be used for switching mains current consumers. For each channel a switch enables selection between automatic, manual on, manual off. In automatic mode the logical state of an output bit switches the relay. For manual mode a 24 V supply is required for the Bus Coupler. The output state can be read by the controller.</p>	 <p>The digital KM2652 output terminal has two independent relay change-over contacts, which can be used for switching mains current consumers. For each channel a switch enables selection between automatic, manual on, manual off. In automatic mode the logical state of an output bit switches the relay. For manual mode a 24 V supply is required for the Bus Coupler. The state of the output and the switch can be read by the controller.</p>
<p>230 V AC (max. switching voltage 250 V AC) – (no power contacts)</p>	
<p>typ. 130 mA</p>	<p>typ. 130 mA</p>
<p>6 A AC/4 A DC at 30 V DC</p>	<p>6 A AC/4 A DC at 30 V DC</p>
<p>1 x 10⁶</p>	<p>1 x 10⁶</p>
<p>1 x 10⁵ (3 A/250 V AC)</p>	<p>1 x 10⁵ (3 A/250 V AC)</p>
<p>max. 10 A starting current</p>	<p>max. 10 A starting current</p>
<p>100 mA (12 V DC)</p>	<p>100 mA (12 V DC)</p>
<p>manual/automatic operation</p>	<p>manual/automatic operation</p>
<p>0...+55 °C</p>	<p>0...+55 °C</p>
<p>CE</p>	<p>CE</p>
<p>approx. 110 g</p>	<p>approx. 110 g</p>
<p>www.beckhoff.com/KM2642</p>	<p>www.beckhoff.com/KM2652</p>

Digital output | Triac outputs up to 230 V AC

In applications with particularly frequent switching operations the service life of a mechanical relay is potentially very short. An electronic switch in the form of triacs and Mosfet transistors is an almost wear-free replacement.

A triac is a robust switch and will only be used as a zero crossing switch in the Bus Terminals. Switch-on only occurs in zero crossing voltage and switch-off only in zero crossing current. Inductive loads are therefore switched off without overvoltage. The disadvantage of a Triac is a relatively high voltage drop in switched-on state, which leads to a higher power dissipation compared to a relay contact. An essential protective circuit leads to a leakage current in switched-off state. The output is not safely isolated from the mains. Triacs need a minimum load so that they remain switched-on, and a minimum voltage for error-free zero crossing detection.

A solid-state output is realised with Mosfet transistors. This implementation is very similar to the relay contact, but not as resilient. The solid-state output always switches immediately (no zero crossing switching) and has high ohmic isolation in switched-off state. Because switching-off takes some milliseconds, no break spark is created even for inductive loads. Solid-state outputs can also switch signals with low voltages and small currents.

When fusing Bus Terminals from the triac/solid-state family it should be noted that electronic switches cannot withstand high short-circuit currents. The fuses which are used should at least be fast-acting (characteristic: F) with low rated/reference current.

2-channel triac output terminal, 12...230 V AC

2-channel triac output terminal, 12...230 V AC

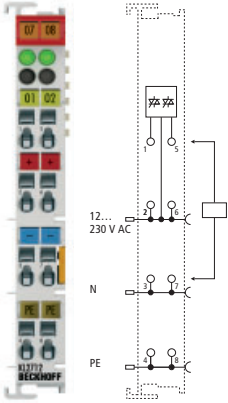
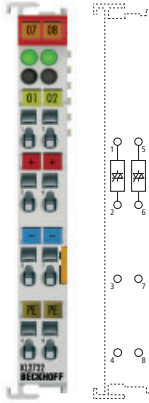
Technical data	KL2712 KS2712	KL2722 KS2722	KL2732
Connection technology	4-wire		2-wire
Load type	ohmic, inductive		
Max. output current	2 x 0.01...0.5 A	1 x 1 A	1 x 1 A
Number of outputs	2 x make contacts	2 x make contacts	2 x make contacts
	 <p>The KL2712 and KL2722 output terminals use a power switch to control mains voltage from 12 V to 230 V AC. The switching element is a Triac which is connected to the power contact potential. As a semiconductor switch, it is not subject to wear.</p>		 <p>The KL2732 output terminal uses a power switch to control mains voltage from 12 V to 230 V AC. The switching element is a Triac. As a semiconductor switch, it is not subject to wear.</p>
Nominal voltage	12...230 V AC		12...230 V AC
Current consumption power contacts	only leakage and load current		– (no power contacts)
Current consumpt. K-bus	typ. 10 mA		typ. 10 mA
Switching times	0.1...10 ms, zero crossing		0.1...10 ms, zero crossing
Frequency range	47...63 Hz		47...63 Hz
Surge voltage protection	> 275 V AC		> 275 V AC
Peak current	40 A (16 ms), 1.5 A (30 s)		40 A (16 ms), 3 A (30 s)
Leakage current	typ. 0.8 mA, max. 1.5 mA (OFF state)		typ. 0.8 mA, max. 1.5 mA (OFF state)
Switch-off time	T/2		T/2
Maximum residual voltage	1.5 V		1.5 V
Special features	reverse motors (blinds)		reverse motors (blinds)
Operating temperature	0...+55 °C		0...+55 °C
Approvals	CE, UL, GL	CE, Ex, GL	CE, GL
Weight	approx. 55 g		approx. 55 g
Further information	www.beckhoff.com/KL2712		www.beckhoff.com/KL2732
Special terminals	KL27x2-0010		KL2732-0010
Distinguishing features	special terminals see page	605	special terminals see page 605

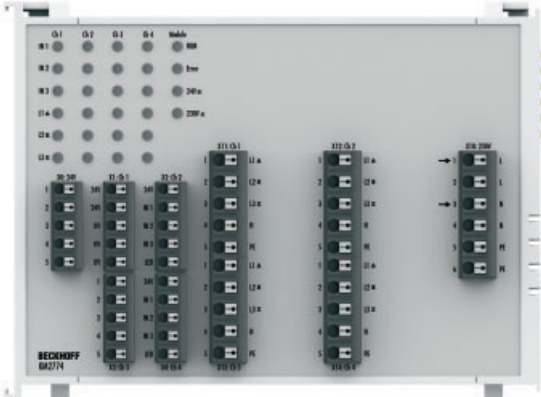
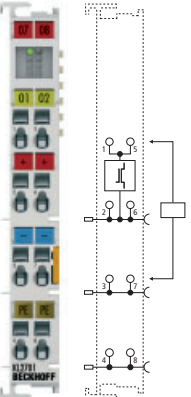
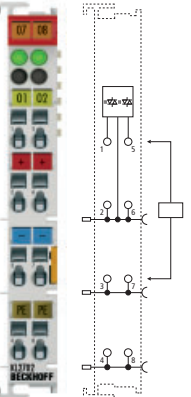
4-channel triac output module for 4 blind motors	1-channel solid state load relay up to 230 V AC/DC	2-channel solid state load relay up to 230 V AC/DC	
KM2774	KL2701 KS2701	KL2702 KS2702	KL2702-0020
mixed	2-/3-/4-wire		
1.5 A per channel	3 A steady load	0.3 A steady load on each channel	1.5 A steady load on each channel
4 x 3 make contacts	1 make contact	2 x make contacts	
 <p>Mixed module 24 V DC/230 V AC for the direct control of blinds applications</p>	 <p>The KL2701 output terminal uses an electronic load relay to switch a mains voltage of up to 230 V AC/DC. The switching element is a high-power MOSFET which is connected to the power contact potential. As a semiconductor switch, it is not subject to wear.</p>	 <p>The KL2702 output terminal uses an electronic load relay to switch a mains voltage of up to 230 V AC/DC. The switching element is a high-power MOSFET which is connected to the power contact potential. As a semiconductor switch, it is not subject to wear.</p>	
80...230 V AC – (no power contacts)	0...230 V AC/DC only leakage and load current	0...230 V AC/DC only leakage and load current	
typ. 30 mA	typ. 65 mA	typ. 10 mA	
0.1...10 ms, zero crossing	1.5...5 ms	1.5...5 ms	
50 Hz	DC > 100 Hz	DC > 100 Hz	
> 275 V AC	> 400 V AC	> 400 V AC	
40 A (16 ms), 3 A (30 s)	5 A (20 s), 50 A (100 ms)	0.5 A (20 s), 1.5 A (100 ms)	
typ. 0.8 mA, max. 1.5 mA (OFF state)	<< 1 mA (OFF state)	<< 1 mA (OFF state)	
T/2	2...4 ms	2...4 ms	
1.5 V	100 mΩ	2.1 Ω	
–	–	–	
0...+55 °C	0...+55 °C	0...+55 °C	
CE	CE	CE, UL, Ex, GL	CE
approx. 270 g	approx. 55 g	approx. 55 g	
www.beckhoff.com/KM2774	www.beckhoff.com/KL2701	www.beckhoff.com/KL2702	

Digital output | Cycle monitoring

The KL2692 Bus Terminal monitors a bit that is toggled by the controller during each cycle. If the toggle signal fails, the terminal switches off two potential-free relays in order to prevent damage to the machine. Failure of the toggle signal may be caused by the PLC cycle stopping, by a fault in the bus cable or connector, or by a fault in a bus device. The cycle monitoring time can be parameterised. The Bus Terminal has an enable input that enables the relay to be switched on if a correct toggle signal is detected.

Cycle monitoring terminal (watchdog)

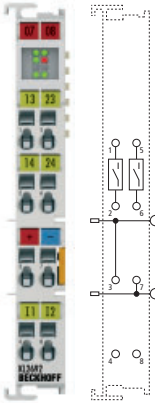
Technical data	KL2692 KS2692
Connection technology	2-wire
Max. output current	3 A
Number of outputs	2 potential-free relay outputs (normally-open contacts)
Number of inputs	2 digital 24 V inputs
	
Nominal voltage	30 V DC
Current consumption power contacts	–
Current consumpt. K-bus	approx. 165 mA
Switching times	parameterisable
Ohmic switching current	5 A AC/DC
Inductive switching current	2 A AC/DC
Operat. cycles mech. (min.)	2 x 10 ⁷
Operat. cycles electr. (min.)	1 x 10 ⁵ (5 A/30 V DC)
Minimum permitted load	10 mA at 5 V DC
Operating temperature	0...+55 °C
Approvals	CE, UL
Weight	approx. 60 g
Further information	www.beckhoff.com/KL2692
Special terminals	KL2692-1001
Distinguishing features	2 digital inputs, 2 potential-free relays, end terminal variant

Digital output | Frequency output (pulse train)

The KL2521-xxxx output terminals provide a parameterisable pulse sequence through both their outputs. The relation between channel A and B is adjustable, e.g. as encoder characteristic. The pulse rate and the frequency are specified by the controller via a 16-bit value. The LEDs are driven in time with the outputs and each displays an active output. The galvanic isolation of the K-bus is realised.

The KL2521 has two RS422-compatible differential outputs, which are fed electrically isolated from the K-bus. For the KL2521-0024 both output channels are implemented as potential-free FET switches and must be fed externally. The 100 mA switch output is short-circuit-proof.

The KL2521 series offers different modes of operation: frequency modulation on the individual channels, incremental encoder or pulse/direction signals. A travel distance control can also be parameterised.

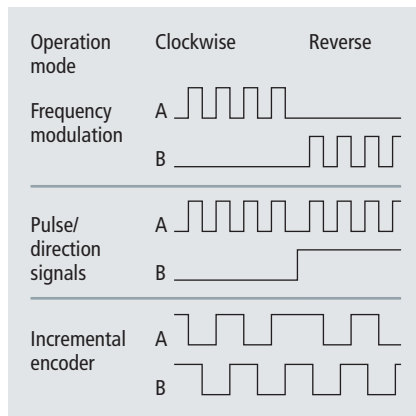

Frequency pulse patterns

	1-channel pulse train output terminal, RS422	1-channel pulse train output terminal, 24 V DC
Technical data	KL2521 KS2521	KL2521-0024 KS2521-0024
Output pattern	pulse direction, encoder simulation	
Max. output current	RS422 specification	0.5 A
Number of outputs	1 channel (2 differential outputs A, B)	1 channel (2 single-ended low side switches A, B)
Number of inputs	2 (+T, +Z)	2 (+T, +Z)
Nominal voltage	RS422 level	24 V DC (externally supplied)
Current consumption power contacts	– (no power contacts)	– (no power contacts)
Current consumption K-bus	typ. 50 mA, max. 120 mA (load-dependent)	typ. 50 mA, max. 120 mA (load-dependent)
PWM clock frequency	1...500 kHz, 50 kHz default	1...500 kHz, 50 kHz default
Duty factor	50 % (±20 %)	50 % (±20 %)
Resolution	max. 15 bits	max. 15 bits
Operating temperature	0...+55 °C	0...+55 °C
Approvals	CE, Ex	CE
Weight	approx. 50 g	approx. 50 g
Further information	www.beckhoff.com/KL2521	www.beckhoff.com/KL2521
Special terminals	KL2521-0010	
Distinguishing features	with additional outputs (230 V AC/DC, 100 mA) instead of the additional inputs of the default variant	

Digital output | 24/50 V DC, PWM output

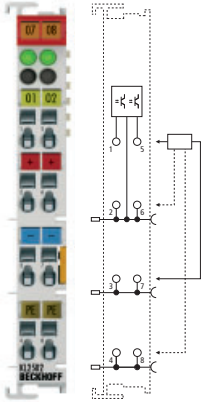
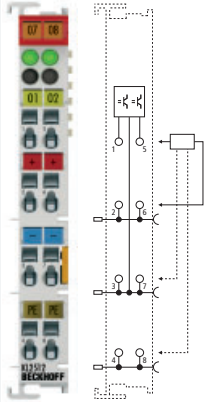
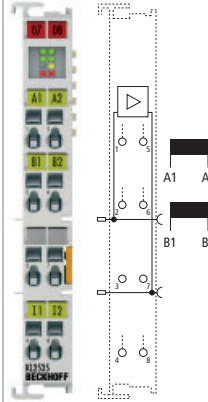
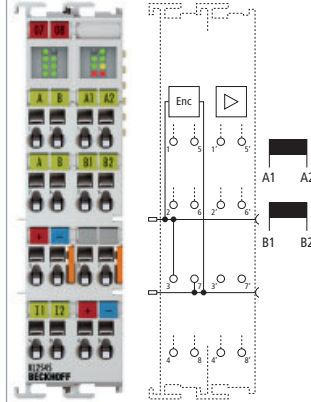
	2-channel pulse width output terminal, 24 V DC	2-channel pulse width output terminal, 24 V DC	2-channel pulse width current terminal, 24 V DC	2-channel pulse width current terminal, 50 V DC
Technical data	KL2502 KS2502	KL2512 KS2512	KL2535 KS2535	KL2545 KS2545
Load type	ohmic		inductive > 1 mH, valves, coils	
Max. output current	0.1 A (1 A driver component) per channel	1.5 A per channel	2 x 1 A (short-circuit-proof, thermal overload-proof for both channels together)	2 x 3.5 A (short-circuit-proof, thermal overload-proof for both channels together)
Number of outputs	2	2	2	2
	 <p>The KL2502 digital output terminal modulates the pulse width of a binary signal, and outputs it electrically isolated from the K-bus. The mark/space ratio is prescribed by a 16-bit value from the automation unit.</p>	 <p>The negative switching KL2512 output terminal enables direct connection of different ohmic loads. The output signal is a pulse-width modulated voltage. The typical load of an LED group or an incandescent lamp is connected between the positive side of the supply voltage and the output of the KL2512.</p>	 <p>The KL2535 digital output terminal controls an output current via pulse width control of the supply voltage. It is electrically isolated from the K-bus. The current value (0 to 1 A) is specified by the automation device via a 16-bit value.</p>	 <p>The KL2545 digital output terminal controls an output current via pulse width control of the supply voltage. It is electrically isolated from the K-bus. The current value (0 to 3.5 A) is specified by the automation device via a 16-bit value.</p>
Nominal voltage	24 V DC (-15 %/+20 %)	24 V DC (-15 %/+20 %)	24 V DC (-15 %/+20 %)	8...50 V DC
Current consum. pow.cont.	typ. 10 mA + load	typ. 10 mA + load	only load	typ. 30 mA + load
Current consumpt. K-bus	typ. 18 mA	typ. 18 mA	typ. 60 mA	typ. 100 mA
PWM clock frequency	1...20 kHz, 250 Hz default	1...20 kHz, 250 Hz default	36 kHz	36 kHz
Duty factor	0...100 % ($T_{ON} > 750 \text{ ns}$, $T_{OFF} > 500 \text{ ns}$)	0...100 %	0...100 % (current-controlled)	0...100 % (current-controlled)
Resolution	max. 10 bits	max. 10 bits	max. 12 bits	max. 12 bits
Operating temperature	0...+55 °C	0...+55 °C	0...+55 °C	0...+55 °C
Approvals	CE, Ex	CE	CE	CE
Weight	approx. 50 g	approx. 50 g	approx. 55 g	approx. 100 g
Further information	www.beckhoff.com/KL2502	www.beckhoff.com/KL2512	www.beckhoff.com/KL2535	www.beckhoff.com/KL2545
Special terminals	KL2502-xxxx			
Distinguishing features	for special terminals see page 605			

Digital output | Universal dimmer up to 230 V AC

To dim light efficiently means electronically regulating the current flow through the lighting medium using the phase control principle. The ratio of the switch-on time to the switch-off time determines the output light quantity via the flow of current. Depending on the load connected (ohmic, capacitive, inductive) either the switch-on time (leading edge phase control | load type: L) or the switch-off time (trailing edge phase control | load type: C, R) must be regulated. The load type of an electronic ballast depends on the transformer used and must be taken into account.

The KL2751 and KL2761 universal dimmer terminals automatically recognise the connected load and select the corresponding control principle. The short-circuit resistance prevents damage to the fuse, so that no additional maintenance work is necessary when exchanging the lamp.

1-channel universal dimmer terminal,
230 V AC

Technical data	KL2751 KS2751	KL2761 KS2761
Connection technology	4-wire	
Load type	ohmic, inductive or capacitive (not mixed), lamp load, automatic load detection	
Max. output current	1.35 A	2.7 A
Number of outputs	1	
Nominal voltage	230 V AC	
Current consumption power contacts	only load	
Current consumpt. K-bus	typ. 65 mA	
Short circuit current	10...20 A	20...40 A
Mains voltage	230 V AC (50 Hz)	
Rated output	300 VA (W)	600 VA (W)
Rated current	max. 1.35 A	max. 2.7 A
Control type	phase control	
Resolution	1 %	
Leakage current	< 1 mA (OFF state)	
Special features	dimmers with fieldbus functionality	
Operating temperature	0...+55 °C	
Approvals	CE	
Weight	approx. 60 g	
Further information	www.beckhoff.com/KL2751	www.beckhoff.com/KL2761
Special terminals	KL2751-0011	KL2761-0011
Distinguishing features	without power contacts	600 W, 50 Hz (without power contacts)

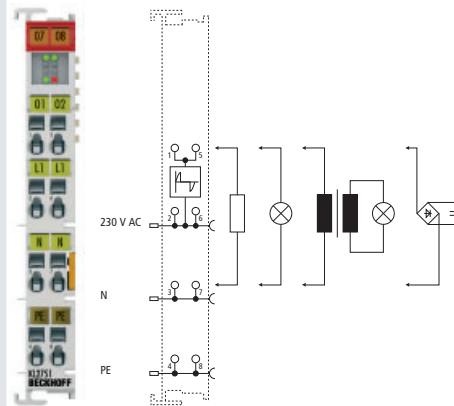

Leading edge phase control

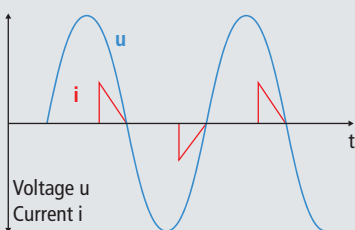

Trailing edge phase control

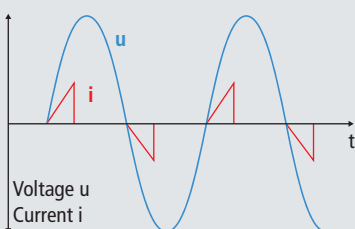

Digital output | 24/50 V DC, stepper motor terminals

Stepper motors are often used in positioning drives. They allow, by the combination of single steps, a positioning process without feedback of the rotor positions. This "open control chain" mode of operation and the longevity of a stepper motor are particularly interesting for price-sensitive fields of application. However, safe positioning is only guaranteed within the performance limits.

In contrast with a DC motor the control of a stepper motor is carried out by the different energisation of the individual motor windings following a defined pattern of pulses. The electromagnetic field of the stator is switched intermittently so that the shaft turns through the step angle α . The motor follows the impulse pattern of the control unit, until the coupled momentum exceeds its holding momentum or the impulse demand is too dynamic, which leads to standstill of the motor. With the KL2531 and KL2541 stepper motor terminals, which are suitable for highly dynamic movement, this problem in areas of higher speeds of rotation can be solved.

The KL2531 and KL2541 stepper motor terminals are designed for direct connection of medium capacity stepper motors. A high frequency clocked PWM output stage regulates the currents through the motor coils. The stepper motor terminals are synchronised with the motor by parameterising. Unipolar as well as bipolar stepper motors can be driven.

Additional inputs support functions like homing and final position monitoring. 64-fold micro stepping ensures particularly quiet and precise motor operation. Together with a stepper motor, the stepper motor terminals represent an inexpensive small servo axis. The KL2541 also includes an incremental encoder interface to read position data.

Both KL2531 and KL2541 stepper motor terminals can be controlled like a servo drive by a speed interface from a Motion Control software such as TwinCAT for example. In applications with a less complex and less powerful CPU the control is also possible via a position interface (travel distance control). The stepper motor terminals move the motor themselves to a desired position. Ramp steepness and maximum speed can be entered as parameters.

Irregular operation at certain speed ranges, particularly without coupled load, indicates that the stepper motor is being run at its resonance frequency. Under certain circumstances the motor may even stop. Resonances in the lower frequency range essentially result from the mechanical motor parameters. Apart from their impact on smooth running, such resonances can lead to significant loss of torque, or even loss of step of the motor, and are therefore particularly undesirable. Due to their sine/cosine current profile, KL2531 and KL2541 stepper motor terminals are able to prevent

this effect in almost all standard motors.

The rotor is not moved from step to step, so it no longer jumps to the next position, but moves through 64 intermediate steps. So the rotor is carefully moved from one step to the next. The usual loss of torque at certain speeds is avoided and operation can be optimised for the particular application. This means that the lower speed range, where particularly high torque is available, can be fully utilised.

The KL2531 stepper motor terminal is designed exclusively for 24 V supply voltage. The motor current can reach up to 1.5 A. The KL2541 covers a supply voltage range from 8 V DC to 50 V DC and also needs a 24 V supply from the power contacts. The motor current can be set from 1 to 5 A.

The peak current may briefly significantly exceed the rated current and in this way makes the whole drive system very dynamic. In such dynamic applications, negative acceleration causes the feedback of energy, which leads to voltage peaks at the power supply unit. A KL9570 buffer capacitor terminal protects from the effects of overvoltage, in that it absorbs some of the energy. If the voltage exceeds the capacity of the terminal, it gets rid of the excess energy via an external resistance.

AS1xxx | Stepper motors see page **776**

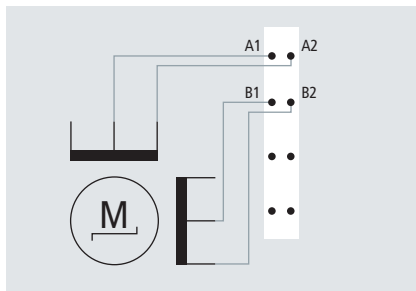

Connection of a unipolar stepper motor

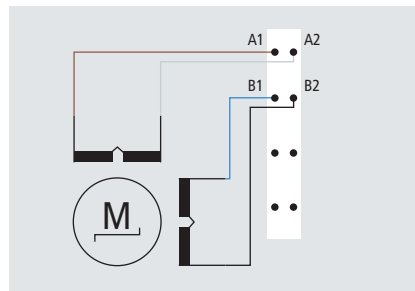

Connection of a bipolar AS10x0 stepper motor, serial

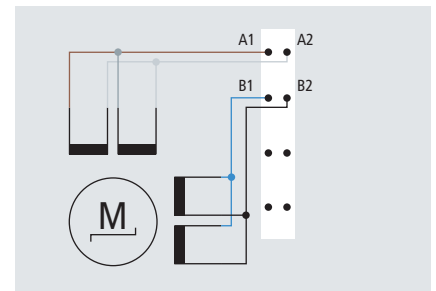

Connection of a bipolar AS10x0 stepper motor, parallel

	Stepper motor terminal 24 V DC, 1.5 A	Stepper motor terminal 50 V DC, 5 A, with incremental encoder
Technical data	KL2531 KS2531	KL2541 KS2541
Connection technology	direct motor connection	
Load type	stepper motors	
Max. output current	1.5 A	5 A
Number of outputs	1 stepper motor	1 stepper motor, encoder input
Nominal voltage	24 V (-15 %/+20 %)	8...50 V DC
Current consumption power contacts	only load	typ. 35 mA
Current consumpt. K-bus	typ. 60 mA	typ. 100 mA
Number of inputs	2	2 for limit position, 4 for an encoder system
Maximum step frequency	125,000 steps/s	125,000 steps/s
Step pattern	full step, half step, up to 64-fold micro stepping	full step, half step, up to 64-fold micro stepping
Current controller frequency	approx. 25 kHz	approx. 25 kHz
Resolution	approx. 5,000 positions in typ. applications (per revolution)	approx. 5,000 positions in typ. applications (per revolution)
Special features	integrated travel distance control	integrated travel distance control
Operating temperature	0...+55 °C	0...+55 °C
Approvals	CE	CE
Weight	approx. 50 g	approx. 100 g
Further information	www.beckhoff.com/KL2531	www.beckhoff.com/KL2541
Special terminals		KL2541-0006
Distinguishing features		stepper motor terminal 50 V DC, 5 A, 5 V encoder supply

Digital output | 24/50 V DC, DC motor output stage

Compared to other motors a DC motor is easier to adjust. The speed of rotation is proportional to the voltage. With the KS2532 Bus Terminal the rotation speed can easily be set through the process data. The integrated compensation of the internal resistance keeps the motor at the desired speed for load changes. A simple drive task can be performed by a simple controller.

For demanding positioning tasks a closed speed control loop with a feedback system is needed. The KL2542 allows connection of an incremental encoder. The control loop can be closed by the higher-level controller.

The peak current may briefly significantly exceed the rated current and in this way makes the whole drive system very dynamic. In such dynamic applications, negative acceleration causes the feedback of energy, which leads to voltage peaks at the power supply unit. A KL9570 buffer capacitor terminal protects from the effects of overvoltage, in that it absorbs some of the energy. If the voltage exceeds a threshold, the terminal dissipates the excess energy via an external resistance.

KL9750 | Buffer capacitor terminal
see page [604](#)

2-channel DC motor
output stage, 24 V DC,
1 A

2-channel DC motor
output stage, 50 V DC,
5 A

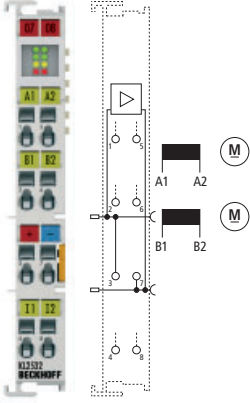
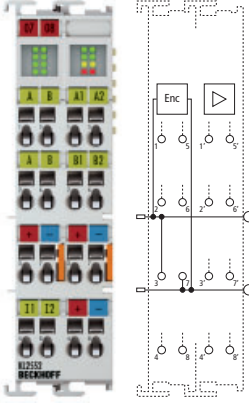
Technical data	KL2532 KS2532	KL2552 KS2552
Connection technology	direct motor connection	
Load type	DC brush motors, inductive	
Max. output current	2 x 1 A (short-circuit-proof, thermal overload-proof for both channels together)	2 x 5 A (short-circuit-proof, thermal overload-proof for both channels together)
Number of outputs	2 DC motors	2 DC motors, encoder input
		
Nominal voltage	24 V DC (-15 %/+20 %)	8...50 V DC
Current consumption power contacts	typ. 30 mA + load	typ. 50 mA
Current consumpt. K-bus	typ. 50 mA	typ. 100 mA
Reverse voltage protection	–	–
PWM clock frequency	30 kHz with 180° phase shift each	30 kHz with 180° phase shift each
Duty factor	0...100 % (voltage-controlled)	0...100 % (voltage-controlled)
Resolution	max. 10 bits current, 16 bits speed	max. 10 bits current, 16 bits speed
Encoder signal	–	5...24 V, 5 mA single-ended
Pulse frequency	–	max. 400,000 increments/s (with 4-fold evaluation)
Operating temperature	0...+55 °C	0...+55 °C
Approvals	CE	CE
Weight	approx. 55 g	approx. 100 g
Further information	www.beckhoff.com/KL2532	www.beckhoff.com/KL2552

Digital output | 230 V AC, AC motor speed controller

When driving working machines whose production or conveying performance can be influenced via the drive speed of the motor, energy can be saved by means of variable speed. This particularly applies if the change in the motor speed is also linked with large changes in the emitted mechanical output. Increase the speed – higher load, decrease – lower load. This procedure is particularly suitable for uncontrolled units with a square load characteristic, because regulating the speed just a little brings about a large change in energy consumption due to its square influence.

Using the KL2791 single-phase AC motor terminal, a single-phase AC motor with a maximum power consumption of 0.2 KW can be operated with speed control depending on the process data. L1 and N of the motor are wired directly to the terminal; this is in turn integrated in the control environment via a Bus Coupler or connected directly to an embedded device. The controller specifies the set value for the motor speed in the form of a 16-bit word; the speed is regulated internally in the terminal. The motor is switched on and off with a practice-proven mains-synchronous pattern, so that the motor consumes less power and the speed falls significantly. This method is well suited to motors with fixed loads, such as pumps and fans, in order to achieve a control range for the flow rate from 10 to 100 %.

1-channel AC motor speed controller, 230 V AC, 200 VA

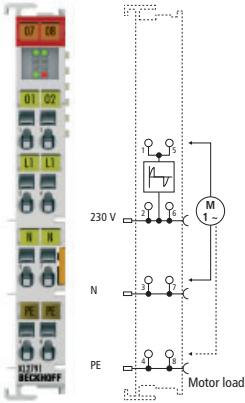
Technical data	KL2791 KS2791	
Connection technology	direct motor connection	
Load type	1-phase AC motors	
Max. output current	0.9 A	
Number of outputs	1 motor	
		
Nominal voltage	230 V AC	
Current consumption power contacts	only load	
Current consumpt. K-bus	typ. 65 mA	
Reverse voltage protection	no	
Rated output	≤ 200 VA	
Control type	phase/full wave control	
Resolution	1 %	
Leakage current	< 1 mA (OFF state)	
Operating temperature	0...+55 °C	
Approvals	CE	
Weight	approx. 60 g	
Further information	www.beckhoff.com/KL2791	
Special terminals	KL2791-0011	KL2791-1200
Distinguishing features	230 V AC, 200 VA, max. 0.9 A, without power contacts	120 V AC, 100 VA

Analog input | -10...+10 V

The KL3xxx Bus Terminals read analog signal voltages in the common standard signal range of -10 to +10 V, 0 to 10 V, 0 to 20 mA and 4 to 20 mA. Inside the terminal the field side of the K-bus is electrically isolated and enables the interconnection to desired potential groups. The 1-channel terminals are available for applications in which each signal must be completely isolated. An additional electrically isolated 24 V DC supply can be created by the application of the KL9560 power supply terminal (24 V DC/24 V DC).

The analog input Bus Terminals differ in their different resolutions of the analog/digital conversion, conversion speed and accuracy. For 1- and 2-channel terminals 1-, 2-, 3- and 4-wire connections are available for the sensors. 4-channel Bus Terminals can only be used with 1- and 2-wire connections. The KL3454 is optimised for the use of 2-wire sensors with 24 V DC supply. The signal current is measured between ground and the input. The second connection point for the sensor is the 24 V supply from the terminal's power contact.

The input circuit of the terminals differs between single-ended and differential inputs. A single-ended input expects a signal with a fixed reference to ground. In practice, single-ended is easily to be wired using single-wire connection. The differential input only measures the difference between both inputs +I and -I. An overlap within the common-mode area (common-mode voltage) has no effect on the result. For measurement two conductors should always be connected; in the case of single-wire connection input -I can be connected to ground.

The product range is rounded off by further special input voltages and covers a wide field of applications for the processing of analog signals. By the expansion of power supply terminals well-stabilised auxiliary voltages from 5 to 15 V can be generated.

1-channel analog input terminal, -10...+10 V, 12 bits, differential input

2-channel analog input terminal, -10...+10 V, 12 bits, differential input

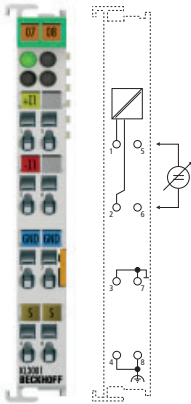
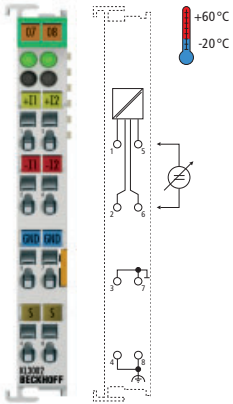
Technical data	KL3001 KS3001	KL3002 KS3002
Signal voltage	-10...+10 V	
Resolution	12 bits (for 0...10 V range: resolution 11 bits)	
Technology	differential input	differential input
Conversion time	~ 1 ms	~ 2 ms
Number of inputs	1	2
	 <p>The KL3001 analog input terminal is characterised by its electrical isolation.</p>	 <p>The KL3002 analog input terminal combines two differential inputs with a common internal ground potential in one housing.</p>
Measuring error	< ±0.3 % (relative to full scale value)	< ±0.3 % (relative to full scale value)
Current consumption power contacts	– (no power contacts)	– (no power contacts)
Current consumpt. K-bus	typ. 65 mA	typ. 65 mA
Internal resistance	> 200 kΩ	> 200 kΩ
Common-mode voltage U_{CM}	35 V max.	35 V max.
Special features	–	–
Operating temperature	0...+55 °C	-20...+60 °C
Approvals	CE, UL, Ex	CE, UL, Ex
Weight	approx. 70 g	approx. 70 g
Further information	www.beckhoff.com/KL3001	www.beckhoff.com/KL3002
Special terminals		KL3002-00xx
Distinguishing features		special terminals see 605

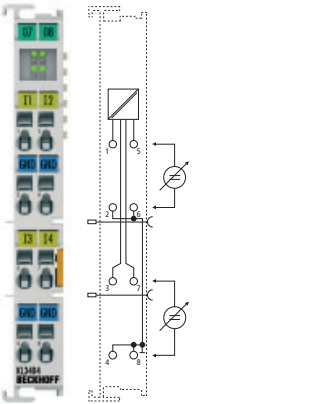
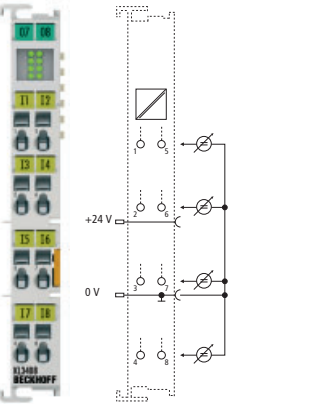
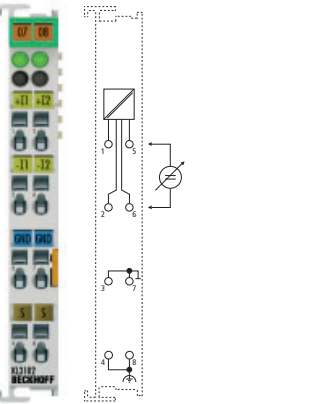
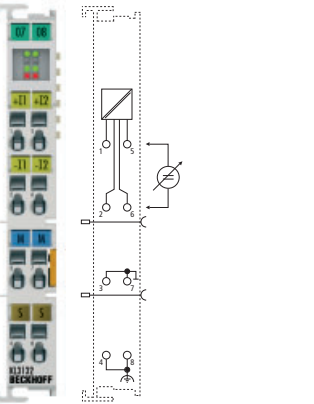
4-channel analog input terminal, -10...+10 V, 12 bits, single-ended	8-channel analog input terminal, -10...+10 V, 12 bits, single-ended	2-channel analog input terminal, -10...+10 V, 16 bits, differential input	2-channel analog input terminal, -10...+10 V, 16 bits, differential input
KL3404 KS3404	KL3408 KS3408	KL3102 KS3102	KL3132
		16 bits (for 0...10 V range: resolution 15 bits)	
single-ended	single-ended	differential input	differential input
~ 2 ms	~ 4 ms	~ 140 ms, configurable to 2 ms	~ 140 ms, configurable
4	8	2	2
 <p>The KL3404 analog input terminal has four inputs, which are implemented in 2-wire technique. The common reference ground of the inputs is the internal ground.</p>	 <p>The KL3408 analog input terminal combines eight inputs in one housing. The use of single conductor connection technology enables the connection of multi-channel sensor technology with minimum space requirements. The reference ground for all inputs is the 0 V power contact.</p>	 <p>The KL3102 analog input terminal combines two differential inputs with a common internal ground potential in one housing.</p>	 <p>The KL3132 analog input terminal is optimised for highly accurate control processes due to its low measuring error of ±0.05 % (in relation to the full scale value). The differential inputs have a common, internal ground potential.</p>
< ±0.3 % (relative to full scale value)	< ±0.3 % (relative to full scale value)	< ±0.3 % (relative to full scale value)	< ±0.05 % (relative to full scale value)
-	-	- (no power contacts)	-
typ. 100 mA	typ. 140 mA	typ. 65 mA	typ. 85 mA
> 130 kΩ	> 130 kΩ	> 200 kΩ	> 200 kΩ
-	-	35 V max.	35 V max.
-	high packing density	-	increased measuring accuracy
0...+55 °C	0...+55 °C	0...+55 °C	0...+55 °C
CE, UL, Ex, GL	CE, UL, Ex, GL	CE, UL, Ex	CE, UL, Ex
approx. 75 g	approx. 75 g	approx. 70 g	approx. 70 g
www.beckhoff.com/KL3404	www.beckhoff.com/KL3408	www.beckhoff.com/KL3102	www.beckhoff.com/KL3132
		KL3102-0050	
		Siemens S7 format	

Analog input | 0...10 V, 0...2 V, 0...500 mV, ±2 V

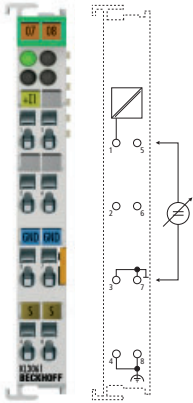
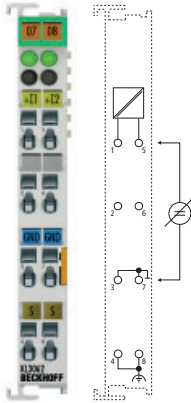
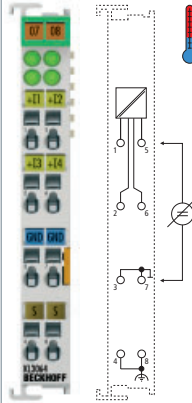
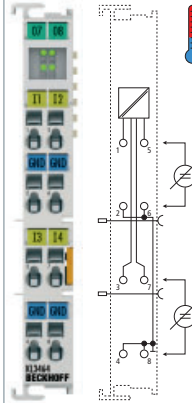
	1-channel analog input terminal, 0...10 V, 12 bits, single-ended	2-channel analog input terminal, 0...10 V, 12 bits, single-ended	4-channel analog input terminal, 0...10 V, 12 bits, single-ended	4-channel analog input terminal, 0...10 V, 12 bits, single-ended
Technical data	KL3061 KS3061	KL3062 KS3062	KL3064 KS3064	KL3464 KS3464
Signal voltage	0...10 V			
Resolution	12 bits			
Technology	single-ended	single-ended	single-ended	single-ended
Conversion time	~ 1 ms	~ 2 ms	~ 4 ms	~ 2 ms
Number of inputs	1	2	4	4
	 <p>The KL3061 analog input terminal is characterised by its fine granularity and electrical isolation.</p>	 <p>The KL3062 analog input terminal combines two single-ended inputs with a common internal ground potential in one housing.</p>	 <p>The KL3064 analog input terminal contains four single-ended inputs with a common internal ground potential.</p>	 <p>The KL3464 analog input terminal combines four single-ended inputs with a common internal ground potential in one housing.</p>
Measuring error	< ±0.3 % (relative to full scale value)	< ±0.3 % (relative to full scale value)	< ±0.3 % (relative to full scale value)	< ±0.3 % (relative to full scale value)
Current consumption power contacts	– (no power contacts)	– (no power contacts)	– (no power contacts)	–
Current consumpt. K-bus	typ. 60 mA	typ. 60 mA	typ. 85 mA	typ. 100 mA
Internal resistance	> 130 kΩ	> 130 kΩ	> 130 kΩ	> 130 kΩ
Common-mode voltage U _{CM}	–	–	–	–
Special features	–	–	–	–
Operating temperature	0...+55 °C	0...+55 °C	-20...+60 °C	-20...+60 °C
Approvals	CE, UL, Ex	CE, UL, Ex	CE, UL, Ex, GL	CE, UL, Ex, GL
Weight	approx. 60 g	approx. 60 g	approx. 80 g	approx. 75 g
Further information	www.beckhoff.com/KL3061	www.beckhoff.com/KL3062	www.beckhoff.com/KL3064	www.beckhoff.com/KL3464
Special terminals		KL3062-00xx	KL3064-00xx	
Distinguishing features		special terminals see 605	special terminals see 605	

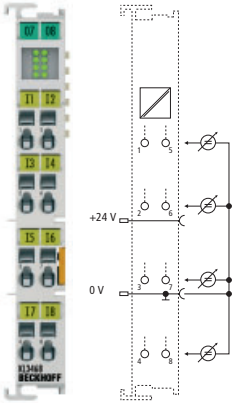
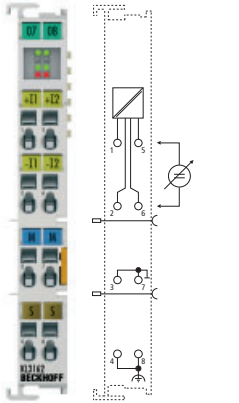
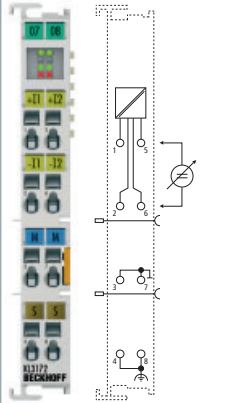
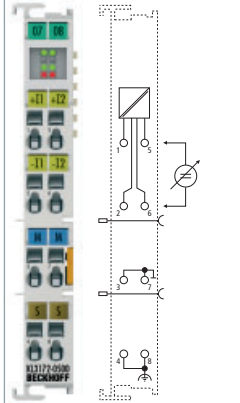
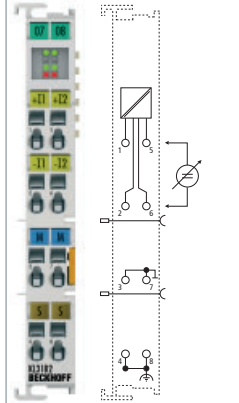
	8-channel analog input terminal, 0...10 V, 12 bits, single-ended	2-channel analog input terminal, 0...10 V, 16 bits, differential input	2-channel analog input terminal, 0...2 V, 16 bits, differential input	2-channel analog input terminal, 0...500 mV, 16 bits, differential input	2-channel analog input terminal, -2...+2 V, 16 bits, differential input
	KL3468 KS3468	KL3162	KL3172	KL3172-0500	KL3182
			0...2 V	0...500 mV	-2...+2 V
		16 bits			
	single-ended	differential input	differential input	differential input	differential input
	~ 4 ms	140 ms, configurable	140 ms, configurable	140 ms, configurable	140 ms, configurable
	8	2	2	2	2
					
	The KL3468 analog input terminal combines eight inputs in one housing. The use of single conductor connection technology enables the connection of multi-channel sensor technology with minimum space requirements. The reference ground for all inputs is the 0 V power contact.	The KL3162 analog input terminal is optimised for highly accurate control processes due to its low measuring error of ±0.05 % (in relation to the full scale value). The differential inputs have a common, internal ground potential.	The KL3172 analog input terminal is optimised for highly accurate control processes due to its low measuring error of ±0.05 % (in relation to the full scale value). The differential inputs have a common, internal ground potential.	The KL3172-0500 analog input terminal is optimised for highly accurate control processes due to its low measuring error of ±0.05 % (in relation to the full scale value). The differential inputs have a common, internal ground potential.	The KL3182 analog input terminal is optimised for highly accurate control processes due to its low measuring error of ±0.05 % (in relation to the full scale value). The differential inputs have a common, internal ground potential.
	< ±0.3 % (relative to full scale value)	< ±0.05 % (relative to full scale value)	< ±0.05 % (relative to full scale value)	< ±0.05 % (relative to full scale value)	< ±0.05 % (relative to full scale value)
	–	–	–	–	–
	typ. 140 mA	typ. 85 mA	typ. 85 mA	typ. 85 mA	typ. 85 mA
	> 130 kΩ	> 200 kΩ	> 200 kΩ	> 200 kΩ	> 200 kΩ
	–	35 V max.	35 V max.	35 V max.	35 V max.
	high packing density	increased measuring accuracy	increased measuring accuracy	increased measuring accuracy	increased measuring accuracy
	0...+55 °C	0...+55 °C	0...+55 °C	0...+55 °C	0...+55 °C
	CE, UL, Ex, GL	CE, UL, Ex	CE, UL, Ex	CE, UL, Ex	CE, UL, Ex
	approx. 75 g	approx. 70 g	approx. 70 g	approx. 70 g	approx. 70 g
	www.beckhoff.com/KL3468	www.beckhoff.com/KL3162	www.beckhoff.com/KL3172	www.beckhoff.com/KL3172	www.beckhoff.com/KL3182

Analog input | 0...20 mA

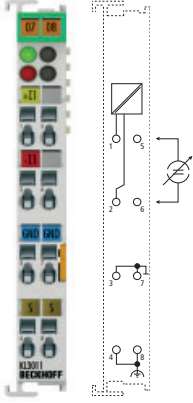
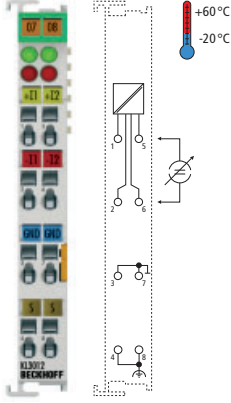
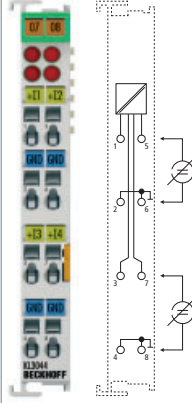
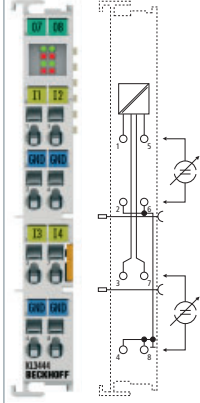
	1-channel analog input terminal, 0...20 mA, 12 bits, differential input	2-channel analog input terminal, 0...20 mA, 12 bits, differential input	4-channel analog input terminal, 0...20 mA, 12 bits, single-ended	4-channel analog input terminal, 0...20 mA, 12 bits, single-ended
Technical data	KL3011 KS3011	KL3012 KS3012	KL3044	KL3444 KS3444
Signal current	0...20 mA			
Resolution	12 bits			
Technology	differential input	differential input	single-ended	single-ended
Conversion time	~ 1 ms	~ 2 ms	~ 4 ms	~ 2 ms
Number of inputs	1	2	4	4
	 <p>The KL3011 analog input terminal is characterised by its electrical isolation. The input channels of the Bus Terminal have differential inputs and possess a common, internal ground potential.</p>	 <p>The KL3012 analog input terminal combines two differential inputs with a common internal ground potential in one housing.</p>	 <p>The KL3044 analog input terminal has four inputs, which are implemented in 2-wire technique. The common reference ground of the inputs is the internal ground.</p>	 <p>The KL3444 analog input terminal has four inputs, which are implemented in 2-wire technique. The common reference ground of the inputs is the internal ground.</p>
Measuring error	< ±0.3 % (relative to full scale value)	< ±0.3 % (relative to full scale value)	< ±0.3 % (relative to full scale value)	< ±0.3 % (relative to full scale value)
Current consum. pow.cont.	– (no power contacts)	– (no power contacts)	– (no power contacts)	–
Current consumpt. K-bus	typ. 60 mA	typ. 60 mA	typ. 65 mA	typ. 85 mA
Internal resistance	80 Ω + 0.7 V	80 Ω + 0.7 V	80 Ω + 0.7 V	< 85 Ω
Common-mode voltage U_{CM}	35 V max.	35 V max.	–	–
Surge voltage resistance	35 V DC	35 V DC	35 V max.	30 V DC
Special features	–	–	–	–
Operating temperature	0...+55 °C	-20...+60 °C	0...+55 °C	0...+55 °C
Approvals	CE, UL, Ex, GL	CE, UL, Ex, GL	CE, UL, Ex, GL	CE, UL, Ex, GL
Weight	approx. 70 g	approx. 70 g	approx. 70 g	approx. 75 g
Further information	www.beckhoff.com/KL3011	www.beckhoff.com/KL3012	www.beckhoff.com/KL3044	www.beckhoff.com/KL3444
Special terminals		KL3012-00xx		
Distinguishing features		special terminals see 605		

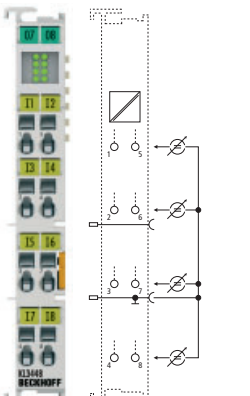
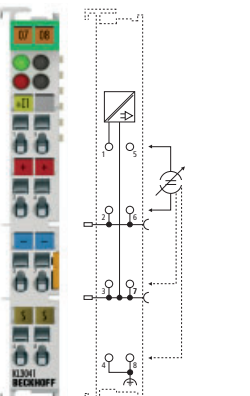
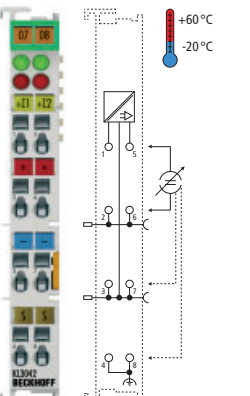
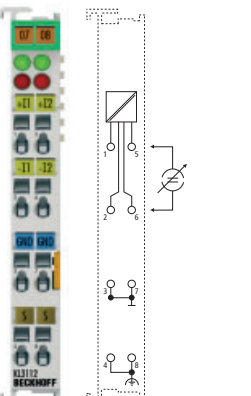
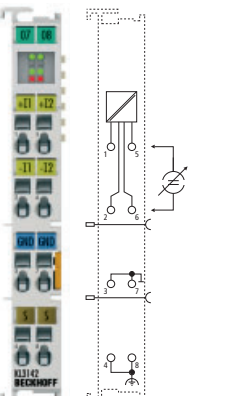
8-channel analog input terminal, 0...20 mA, 12 bits, single-ended	1-channel analog input terminal, 0...20 mA, 12 bits, with sensor supply	2-channel analog input terminal, 0...20 mA, 12 bits, with sensor supply	2-channel analog input terminal, 0...20 mA, 15/16 bits, differential input	2-channel analog input terminal, 0...20 mA, 16 bits, differential input
KL3448 KS3448	KL3041 KS3041	KL3042 KS3042	KL3112	KL3142
single-ended	single-ended	single-ended	15 bit, configurable to 16 bit	16 bits
~ 4 ms	~ 1 ms	~ 2 ms	differential input	differential input
8	1	2	140 ms, configurable to 2 ms	140 ms, configurable
 <p>The KL3448 analog input terminal combines eight inputs in one housing. The use of single conductor connection technology enables the connection of multi-channel sensor technology with minimum space requirements. The reference ground for all inputs is the 0 V power contact.</p>	 <p>The job of the KL3041 and KL3042 analog input terminals is to supply power to measuring transducers located in the field and to transmit analog measurement signals with electrical isolation to the automation device. The voltage for the sensors is supplied to the terminals via the power contacts. The power contacts can optionally be supplied with operating voltage in the standard way or via a supply terminal (KL9560) with electrical isolation. The 0 V power contact is the reference potential for the inputs.</p>		 <p>The KL3112 analog input terminal combines two differential inputs with a common internal ground potential in one housing.</p>	 <p>The KL3142 analog input terminal is optimised for highly accurate control processes due to its low measuring error of ±0.05% (in relation to the full scale value). The differential inputs have a common, internal ground potential.</p>
< ±0.3 % (relative to full scale value)	< ±0.3 % (relative to full scale value)	< ±0.3 % (relative to full scale value)	< ±0.3 % (relative to full scale value)	< ±0.05 % (relative to full scale value)
–	only load	only load	– (no power contacts)	–
typ. 105 mA	typ. 65 mA	typ. 65 mA	typ. 60 mA	typ. 85 mA
< 85 Ω	80 Ω + 0.7 V	80 Ω + 0.7 V	50 Ω typ. shunt, load: 60 Ω + diode voltage	1 Ω typ. shunt
–	–	–	35 V max.	±10 V max.
30 V DC	35 V max.	35 V max.	35 V DC	35 V DC
high packing density	with sensor supply	with sensor supply	–	increased measuring accuracy
0...+55 °C	0...+55 °C	-20...+60 °C	0...+55 °C	0...+55 °C
CE, UL, Ex, GL	CE, UL, Ex, GL	CE, UL, Ex, GL	CE, UL, Ex	CE, UL, Ex
approx. 75 g	approx. 70 g	approx. 70 g	approx. 70 g	approx. 70 g
www.beckhoff.com/KL3448	www.beckhoff.com/KL3041	www.beckhoff.com/KL3042	www.beckhoff.com/KL3112	www.beckhoff.com/KL3142
		KL3042-00xx	KL3112-0050	
		special terminals see 605	special terminals see 605	

Analog input | 4...20 mA

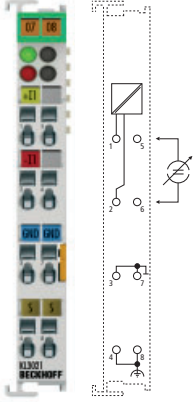
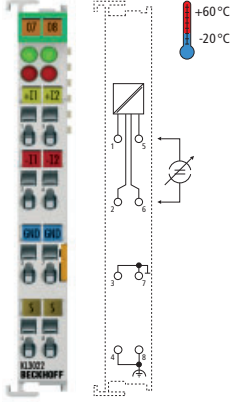
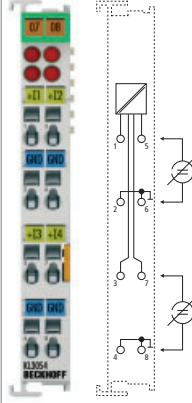
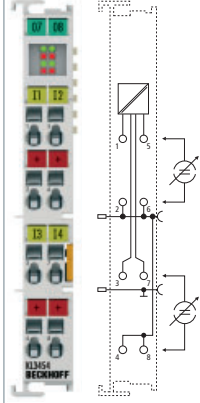
	1-channel analog input terminal, 4...20 mA, 12 bits, differential input	2-channel analog input terminal, 4...20 mA, 12 bits, differential input	4-channel analog input terminal, 4...20 mA, 12 bits, single-ended	4-channel analog input terminal, 4...20 mA, 12 bits, single-ended
Technical data	KL3021 KS3021	KL3022 KS3022	KL3054	KL3454 KS3454
Signal current	4...20 mA			
Resolution	12 bits			
Technology	differential input	differential input	single-ended	single-ended
Conversion time	~ 1 ms	~ 2 ms	~ 4 ms	~ 2 ms
Number of inputs	1	2	4	4
	 <p>The KL3021 analog input terminal is characterised by its fine granularity and electrical isolation. The input channels of the Bus Terminal have differential inputs and possess a common, internal ground potential.</p>	 <p>The KL3022 analog input terminal combines two differential inputs with a common internal ground potential in one housing.</p>	 <p>The KL3054 analog input terminal has four inputs, which are implemented in 2-wire technique. The common reference ground of the inputs is the internal ground.</p>	 <p>In the KL3454 Bus Terminal, the four inputs are 2-wire versions and have a common ground potential. The 24 V power contact is connected to the terminal in order to enable the connection of 2-wire sensors.</p>
Measuring error	< ±0.3 % (relative to full scale value)	< ±0.3 % (relative to full scale value)	< ±0.3 % (relative to full scale value)	< ±0.3 % (relative to full scale value)
Current consum. pow.cont.	– (no power contacts)	– (no power contacts)	– (no power contacts)	only load
Current consumpt. K-bus	typ. 60 mA	typ. 60 mA	typ. 75 mA	typ. 85 mA
Internal resistance	80 Ω + 0.7 V	80 Ω + 0.7 V	80 Ω + 0.7 V	< 85 Ω
Common-mode voltage U_{CM}	35 V max.	35 V max.	–	–
Surge voltage resistance	35 V DC	35 V DC	35 V max.	30 V DC
Special features	–	–	for 2-wire sensors	–
Operating temperature	0...+55 °C	-20...+60 °C	0...+55 °C	0...+55 °C
Approvals	CE, UL, Ex	CE, UL, Ex, GL	CE, UL, Ex, GL	CE, UL, Ex, GL
Weight	approx. 70 g	approx. 70 g	approx. 70 g	approx. 75 g
Further information	www.beckhoff.com/KL3021	www.beckhoff.com/KL3022	www.beckhoff.com/KL3054	www.beckhoff.com/KL3454
Special terminals		KL3022-00xx	KL3054-0050	
Distinguishing features		special terminals see 605	Siemens S7 format	

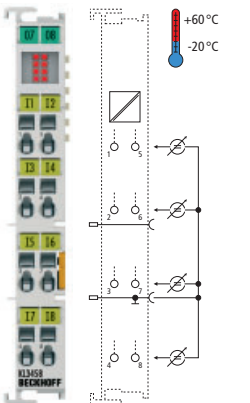
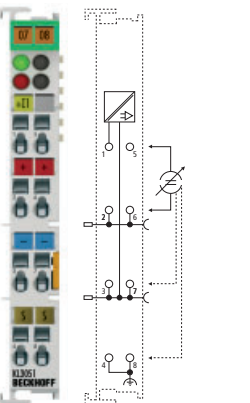
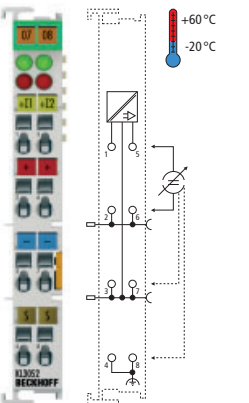
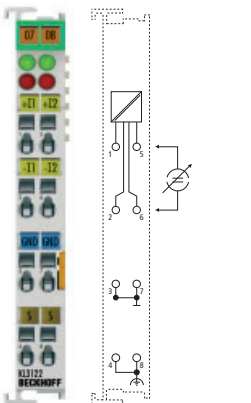
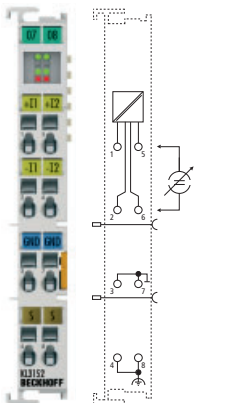
8-channel analog input terminal, 4...20 mA, 12 bits, single-ended	1-channel analog input terminal, 4...20 mA, 12 bits, with sensor supply	2-channel analog input terminal, 4...20 mA, 12 bits, with sensor supply	2-channel analog input terminal, 4...20 mA, 15/16 bits, differential input	2-channel analog input terminal, 4...20 mA, 16 bits, differential input
KL3458 KS3458	KL3051 KS3051	KL3052 KS3052	KL3122	KL3152
			15 bit, configurable to 16 bit	16 bits
single-ended	single-ended	single-ended	differential input	differential input
~ 4 ms	~ 1 ms	~ 2 ms	140 ms, configurable to 2 ms	140 ms, configurable
8	1	2	2	2
 <p>The KL3458 analog input terminal combines eight inputs in one housing. The use of single conductor connection technology enables the connection of multi-channel sensor technology with minimum space requirements. The reference ground for all inputs is the 0 V power contact.</p>	 <p>The job of the KL3051 and KL3052 analog input terminals is to supply power to measuring transducers located in the field and to transmit analog measurement signals with electrical isolation to the automation device. The voltage for the sensors is supplied to the terminals via the power contacts. The power contacts can optionally be supplied with operating voltage in the standard way or via a power feed terminal (KL9xxx) with electrical isolation. The 0 V power contact is the reference potential for the inputs.</p>		 <p>The KL3122 analog input terminal combines two differential inputs with a common internal ground potential in one housing.</p>	 <p>The KL3152 analog input terminal is optimised for highly accurate control processes due to its low measuring error of ±0.05 % (in relation to the full scale value). The differential inputs have a common, internal ground potential.</p>
< ±0.3 % (relative to full scale value)	< ±0.3 % (relative to full scale value)	< ±0.3 % (relative to full scale value)	< ±0.3 % (relative to full scale value)	< ±0.05 % (relative to full scale value)
–	only load	only load	– (no power contacts)	–
typ. 105 mA	typ. 65 mA	typ. 65 mA	typ. 60 mA	typ. 85 mA
< 85 Ω	80 Ω + 0.7 V	80 Ω + 0.7 V	50 Ω typ. shunt, load: 60 Ω + diode voltage	1 Ω typ. shunt
–	–	–	35 V max.	±10 V max.
30 V DC	35 V max.	35 V max.	35 V DC	35 V DC
high packing density	with sensor supply	with sensor supply	–	increased measuring accuracy
-20...+60 °C	0...+55 °C	-20...+60 °C	0...+55 °C	0...+55 °C
CE, UL, Ex, GL	CE, UL, Ex, GL	CE, UL, Ex, GL	CE, UL, Ex	CE, UL, Ex
approx. 75 g	approx. 70 g	approx. 70 g	approx. 70 g	approx. 70 g
www.beckhoff.com/KL3458	www.beckhoff.com/KL3051	www.beckhoff.com/KL3052	www.beckhoff.com/KL3122	www.beckhoff.com/KL3152
		KL3052-00xx	KL3122-0050	
		special terminals see 605	special terminals see 605	

Analog input | Resistance thermometer (RTD, PT100)

The KL32xx Bus Terminals are intended for direct connection of resistance thermometers. The resistance is measured with a small measurement current and the temperature value is calculated by a linearisation corresponding to the sensor type which has been implemented.

In practice, platinum and nickel sensors with different resistance values are used. The resistance value of the sensor is always defined at 0 °C:

- PT100 = 100 Ω at 0 °C
- PT1000 = 1000 Ω at 0 °C
- Ni100 = 100 Ω at 0 °C
- ...

The Bus Terminals support 2-, 3- or 4-wire measurement. The measurement and the sensor can be used in any combination, depending on the type of application. For 2-wire measurement 1000 Ω sensors are recommended to reduce the influence of the conductor resistance.

2-channel analog input terminal, PT100 (RTD), high-precision

1-channel analog input terminal, PT100 (RTD)

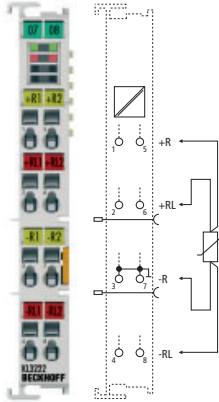
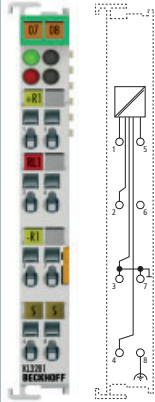
Technical data	KL3222 KS3222	KL3201 KS3201
Sensor types	PT100, PT200, PT500, PT1000, Ni100, Ni120, Ni1000 resistance measurement (e.g. potentiometer, 10 Ω...1.2/5 kΩ)	
Resolution	0.01 °C per digit	
Technology	2-/3-/4-wire	2-/3-wire
Conversion time	typ. 50 ms	~ 200 ms
Number of inputs	2	1
	 <p>The Bus Terminal's standard settings are: resolution 0.01 °C in the temperature range of PT100 sensors in 4-wire connection.</p>	 <p>The Bus Terminal's standard settings are: resolution 0.1 °C in the temperature range of PT100 sensors in 3-wire connection.</p>
Measuring error	0.1 °C at 40 °C ambient temperature, 4-wire connection, PT100 sensors and 50 Hz filter	< ±1 °C
Measuring range	-200...+850 °C (PT sensors); -60...+250 °C (Ni sensors); -200...+320 °C (high-precision)	-200...+850 °C (PT sensors); -60...+250 °C (Ni sensors)
Current consumption power contacts	–	– (no power contacts)
Current consumpt. K-bus	typ. 60 mA	typ. 60 mA
Measuring current	typ. 0.5 mA	typ. 0.5 mA
Special features	open-circuit recognition, high-precision	open-circuit recognition
Operating temperature	0...+55 °C	0...+55 °C
Approvals	CE	CE, UL, Ex
Weight	approx. 70 g	approx. 70 g
Further information	www.beckhoff.com/KL3222	www.beckhoff.com/KL3201
Special terminals		
Distinguishing features		

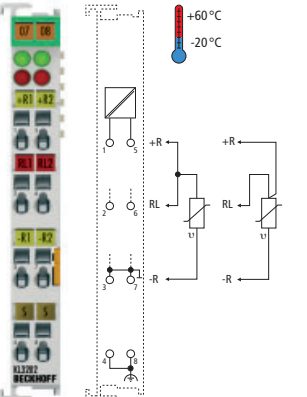
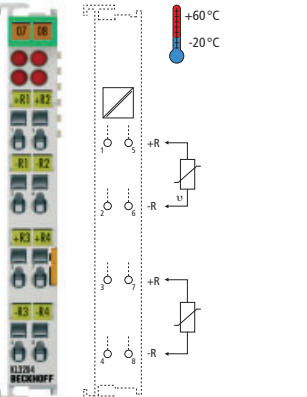
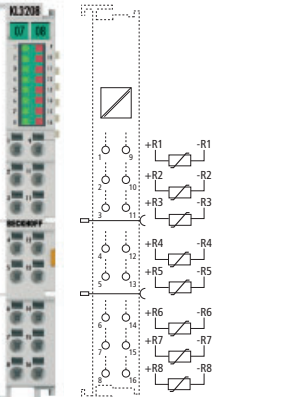
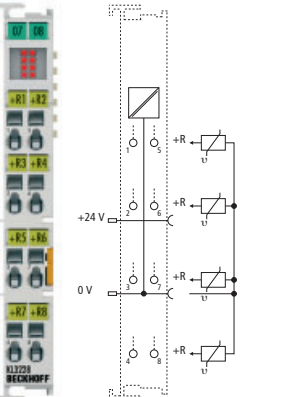
2-channel analog input terminal, PT100 (RTD)	4-channel analog input terminal, PT100 (RTD)	8-channel analog input terminal, PT1000, Ni1000 (RTD)	8-channel analog input terminal, PT1000, Ni1000 (RTD)
KL3202 KS3202	KL3204 KS3204	 KL3208-0010	KL3228 KS3228
		PT1000, Ni1000, PTC	
2-/3-wire ~ 250 ms	2-wire ~ 250 ms	2-wire ~ 1 s	1-wire ~ 1 s
2	4	8	8
			
<p>The Bus Terminal's standard settings are: resolution 0.1 °C in the temperature range of PT100 sensors in 3-wire connection.</p>	<p>The Bus Terminal's standard settings are: resolution 0.1 °C in the temperature range of PT100 sensors.</p>	<p>The Bus Terminal's standard settings are: resolution 0.25 °C in the temperature range of Ni1000 sensors.</p>	<p>The Bus Terminal's standard settings are: resolution 0.1 °C in the temperature range of Ni1000 sensors. The inputs have a common, internal ground potential.</p>
< ±1 °C	< ±1 °C	-20...+60 °C: ±0.25 °C at 25 °C ambient temperature; -50...+150 °C: ±1.5 °C	~ ±1 °C, depending on wiring
-200...+850 °C (PT sensors); -60...+250 °C (Ni sensors)	-200...+850 °C (PT sensors); -60...+250 °C (Ni sensors)	-50...+150 °C (PT sensors); -50...+150 °C (Ni sensors)	-50...+150 °C (PT sensors); -50...+150 °C (Ni sensors)
– (no power contacts)	– (no power contacts)	–	–
typ. 60 mA	typ. 60 mA	typ. 85 mA	typ. 85 mA
typ. 0.5 mA	typ. 0.5 mA	~ 0.5 mA typ.	~ 0.5 mA typ.
open-circuit recognition	open-circuit recognition	open-circuit recognition, cable resistance calibration, particularly suitable for building automation	open-circuit recognition
-20...+60 °C	-20...+60 °C	0...+55 °C	0...+55 °C
CE, UL, Ex	CE, UL, Ex	CE	CE, UL, Ex
approx. 70 g	approx. 70 g	approx. 75 g	approx. 75 g
www.beckhoff.com/KL3202	www.beckhoff.com/KL3204	www.beckhoff.com/KL3208	www.beckhoff.com/KL3228
KL3202-00xx			
special terminals see	605		

 For availability status see Beckhoff website at: www.beckhoff.com/KL3208

Analog input | Thermocouple

Thermocouples can be classified as active transducers. They exploit the thermo-electric effect (Seebeck, Peltier, Thomson). Where two electrical conductors of different materials (e.g. iron and constantan) make contact, a contact voltage occurs at the contact points, which is clearly a function of temperature and so is called thermovoltage. Due to changes in the material during the implementation of a thermocouple, at least two of such material pairings occur. One is placed at the measurement location, the other is the so-called comparison point, which is normally located in the measurement device. In order to compensate for the reference point effect, the temperature at the reference point must be known. For the KL331x this is the connection point of the thermocouple to the terminal contacts, which is why the terminal contact temperature is specially measured here.

Thermocouples represent economical and easy to install sensors for temperature measurement with reduced need for accuracy. Depending on the type of thermocouple, temperatures from -200 to +2,300 °C can be measured. The linearisation and cold junction compensation is carried out by a characteristic curve on a microprocessor. The directions in the documentation, concerning earthing and thermocouples which are not potential-free, must be observed. An error LED indicates a broken wire.

1-channel analog input terminal,
thermocouple with open-circuit recognition

Technical data	KL3311
Thermocouple sensor types	types J, K, L, B, E, N, R, S, T, U (default setting type K), mV measurement
Resolution	0.1 °C per digit
Technology	2-wire
Conversion time	~ 200 ms
Number of inputs	1

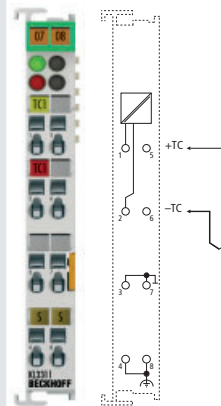

The analog input terminal KL3311 enables direct connection of a thermocouple. The circuit of the Bus Terminal can operate thermocouples using 2-wire technique. Linearisation over the full temperature range is realised with the aid of a microprocessor. Compensation for the cold junction is made through an internal temperature measurement at the terminal. The KL3311 can also be used for mV measurement.

Measuring error	< ±0.5 % (relative to full scale value)
Measuring range	in the range defined in each case for the sensor (default setting: type K; -100...+1,370 °C); mV measurement: ±30 mV...±120 mV
Current consumption power contacts	– (no power contacts)
Current consumpt. K-bus	typ. 65 mA
Special features	electrically isolated
Operating temperature	0...+55 °C
Approvals	CE, UL, Ex
Weight	approx. 70 g
Further information	www.beckhoff.com/KL3311
Special terminals	
Distinguishing features	

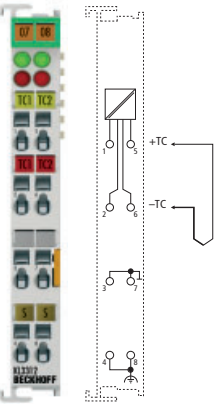
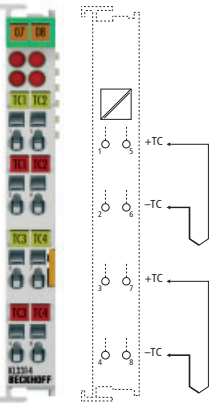
<p>2-channel analog input terminal, thermocouple with open-circuit recognition</p>	<p>4-channel analog input terminal, thermocouple with open-circuit recognition</p>
<p>KL3312</p>	<p>KL3314</p>
<p>2-wire</p>	<p>2-wire</p>
<p>~ 250 ms</p>	<p>~ 250 ms</p>
<p>2</p>	<p>4</p>
 <p>The KL3312 analog input terminal allows two thermocouples to be connected directly. The circuit of the Bus Terminal can operate thermocouples using 2-wire technique. Linearisation over the full temperature range is realised with the aid of a microprocessor. Compensation for the cold junction is made through an internal temperature measurement at the terminals. The KL3312 can also be used for mV measurement.</p>	 <p>The KL3314 analog input terminal allows four thermocouples to be connected directly. The circuit of the Bus Terminals can operate thermocouples using 2-wire technique. Linearisation over the full temperature range is realised with the aid of a microprocessor. Compensation for the cold junction is made through an internal temperature measurement at the terminals. The KL3314 can also be used for mV measurement.</p>
<p>< ±0.5 % (relative to full scale value)</p>	<p>< ±0.5 % (relative to full scale value)</p>
<p>in the range defined in each case for the sensor (default setting: type K; -100...+1,370 °C); mV measurement: ±30 mV...±120 mV</p>	<p>in the range defined in each case for the sensor (default setting: type K; -100...+1,370 °C); mV measurement: ±30 mV...±120 mV</p>
<p>– (no power contacts)</p>	<p>– (no power contacts)</p>
<p>typ. 65 mA</p>	<p>typ. 75 mA</p>
<p>–</p>	<p>–</p>
<p>0...+55 °C</p>	<p>0...+55 °C</p>
<p>CE, UL, Ex</p>	<p>CE, UL, Ex</p>
<p>approx. 70 g</p>	<p>approx. 75 g</p>
<p>www.beckhoff.com/KL3312</p>	<p>www.beckhoff.com/KL3314</p>
<p>KL3312-xxxx</p>	<p>KL3314-xxxx</p>
<p>special terminals see page</p>	<p>special terminals see page</p>

Analog input | Resistor bridge

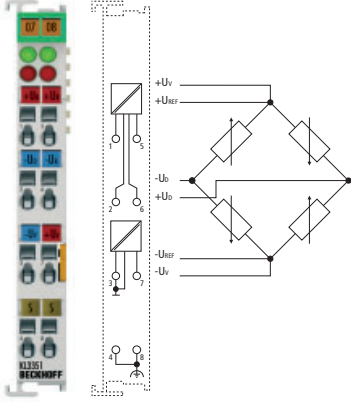
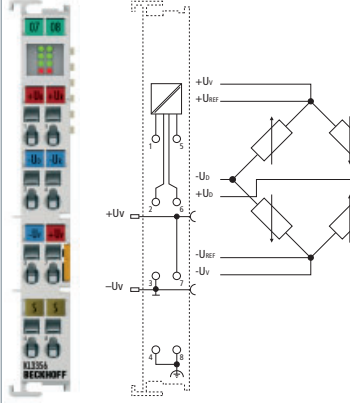
	1-channel analog input terminal, resistor bridge (strain gauge)	1-channel analog input terminal, accurate resistor bridge evaluation
Technical data	KL3351 KS3351	KL3356 KS3356
Signal voltage	U_D : -16...+16 mV U_{REF} : -10...+10 V	U_D : -20...+20 mV U_{REF} : -12...+12 V
Resolution	16 bits	
Technology	DMS connection	DMS connection
Conversion time	< 250 ms, configurable	< 250 ms, configurable
Number of inputs	2, for one resistor bridge	2, for one resistor bridge
	 <p>The KL3351 analog input terminal permits direct connection of a resistor bridge. The bridge voltage, U_D, and the supply voltage, U_{REF}, to the bridge are digitised with 16 bit resolution, and are transmitted along an electrically isolated channel to the supervising automation system. The input channels are available in the form of two 16 bit values for further processing. The resulting measurement can be calculated from the formula: measurement = U_D / U_{REF}. Precise acquisition of the supply voltage along with the bridge voltage compensates for long-term and temperature drift.</p>	 <p>The KL3356 analog input terminal permits direct connection of a resistor bridge. Its improved input circuit makes the KL3356 significantly more accurate than the KL3351. The ratio between the bridge voltage U_D and the supply voltage U_{REF} is determined in the input circuit. In order to achieve good long-term stability, the complete circuit is re-calibrated at least every three minutes. This procedure can be synchronised by the control in order to prevent the calibration leading to a delay in the production process.</p>
Measuring error	< ± 0.1 % (relative to full scale value)	< ± 0.01 % (relative to full scale value)
Current consumption power contacts	– (no power contacts)	only load
Current consumpt. K-bus	typ. 65 mA	typ. 85 mA
Internal resistance	> 200 k Ω (U_{REF}), > 1 M Ω (U_D)	> 200 k Ω (U_{REF}), > 1 M Ω (U_D)
Power supply U_V	5 V DC, max. 20 mA	via power contacts
Filter	50 Hz, configurable	50 Hz, configurable
Special features	with internal bridge supply	increased measuring accuracy, self-calibration
Operating temperature	0...+55 °C	0...+55 °C
Approvals	CE, UL, Ex	CE, UL, Ex
Weight	approx. 70 g	approx. 75 g
Further information	www.beckhoff.com/KL3351	www.beckhoff.com/KL3356
Special terminals	KL3351-0001	
Distinguishing features	with faster measurement time approx. 10 ms	

Analog input | Oscilloscope

	1-channel analog input terminal, oscilloscope, -16...+16 mV	2-channel analog input terminal, oscilloscope, -10...+10 mV
Technical data	KL3361 KS3361	KL3362 KS3362
Signal voltage	U_{in} : -16...+16 mV	-10...+10 V
Resolution	14 bits + sign	
Technology	high-speed data logger	high-speed data logger
Conversion time	< 100 μ s, configurable (10 μ s with fast sampling mode)	
Number of inputs	1 analog, 1 trigger	2 analog, 1 trigger
	<p>The KL3361 and KL3362 analog input terminals make it possible to perform non-central preliminary processing of analog values. The input values are digitised with a 14-bit resolution and written into an internal memory. An efficient processor can pre-process the values. Limit values, maximum and minimum values will be determined or monitored. The Bus Terminals can also carry out envelope curve monitoring. A trigger starts cyclical processes. The result or all the measured values are transported to the higher-level automation unit.</p>	
Measuring error	< ± 1 % (relative to full scale value)	< ± 0.5 % (relative to full scale value)
Current consumption power contacts	– (no power contacts)	– (no power contacts)
Current consumption K-bus	typ. 120 mA with external DMS power supply, typ. 140 mA with internal DMS power supply from terminal (4 x 350 Ω)	typ. 120 mA
Internal resistance	> 1 M Ω (U_s)	> 500 k Ω
Supply voltage	5 V DC, max. 20 mA	–
Power supply	via the K-bus	via the K-bus
Internal memory	32 kbytes	32 kbytes
Special features	high-speed strain gauge analysis (for all fieldbuses)	high-speed analog analysis
Operating temperature	0...+55 $^{\circ}$ C	0...+55 $^{\circ}$ C
Approvals	CE, UL, Ex	CE, UL, Ex
Weight	approx. 55 g	approx. 55 g
Further information	www.beckhoff.com/KL3361	www.beckhoff.com/KL3362

Analog input | Power measurement

The KL3403 Bus Terminal enables the measurement of all relevant electrical data of the supply network. The voltage is measured via the direct connection of L1, L2, L3 and N. The current of the three phases L1, L2 and L3 is fed via simple current transformers. All measured currents and voltages are available as root-mean-square values. In the KL3403 version, the effective power and the energy consumption for each phase are calculated. Through the relationship of the root-mean-square values of voltage and current all other information, such as effective power P , apparent power S or phase shift angle $\cos \varphi$ can be derived. For each fieldbus, KL3403 provides a comprehensive network analysis and an energy management option.

3-phase power measurement terminal

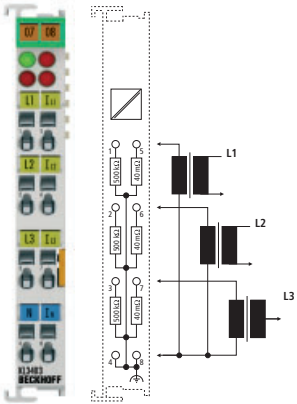
Technical data	KL3403 KS3403	KL3403-0010
Measuring voltage	max. 500 V AC 3~ (ULx-N: max. 288 V AC)	
Resolution	16 bits (21 bits, internal)	
Technology	3-phase connection technique	
Update time	50 ms per measured value preset, free configurable	
Number of inputs	3 phases + N	
		
Measuring error	0.5 % relative to full scale value (U, I), 1 % calculated value	
Current consumption power contacts	– (no power contacts)	
Current consumpt. K-bus	typ. 115 mA	
Measuring procedure	true RMS with 64,000 samples/s	
Measured values	current, voltage, effective power, energy, $\cos \varphi$, peak values U, I and P, frequency	
Measuring current	max. 1 A, via measuring transformers x A/1 A	max. 5 A (AC/DC), via measuring transformers x A/5 A
Electrical isolation	1,500 V (terminal/K-bus)	
Special features	energy meter, power measurement, True RMS	
Operating temperature	0...+55 °C	
Approvals	CE, UL	
Weight	approx. 75 g	
Further information	www.beckhoff.com/KL3403	
Special terminals	KL3403-0020	KL3403-0022
Distinguishing features	current path designed for 20 mA, optimised for electronic current transformer	current path and voltage input designed for 20 mA

Analog input | Digital multimeter

The KL3681 Bus Terminal enables measurement of currents and voltages in a wide input range. The measuring ranges are switched automatically, as usual in advanced digital multimeters. There are two current paths available for current measurement. One of them is a high current path for up to 10 A. The current and the voltage measurement facility can be used for DC and AC. The alternating parameters are output as true RMS values. The measurement readings can be read and processed with commercially available fieldbuses. At the same time the KL3681 enables the measuring type and range to be set via the bus.

Excellent interference immunity is achieved through the fully electrically isolated design of the electronic measuring system and the dual slope conversion system. High precision and simple, high impedance measurement from 300 mV to 300 V allow the Bus Terminal to be used like a modern digital multimeter.

In measuring applications in particular, the voltage to be expected is often not yet known during the planning phase. Automatic adjustment of the measurement range simplifies use and reduces stock levels. The selected measuring type and overload are indicated by LEDs.

Digital multimeter terminal

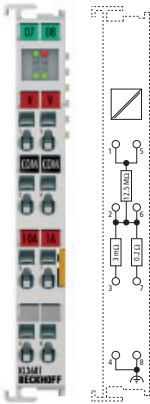
Technical data	 KL3681 KS3681
Measuring voltage	300 mV, 3 V, 30 V, 300 V
Resolution	18 bit + sign in each measurement range
Technology	wide-range current and voltage measurement
Update time	0.5 s, 1 s for measuring range selection
Number of inputs	1 voltage; 2 current (10 A/1 A)
	
Measuring error	0.01 % DC voltage measurement at 25 °C
Current consumption power contacts	– (no power contacts)
Current consumpt. K-bus	typ. 100 mA
Measuring procedure	DC with arithmetic averaging, AC with true RMS value calculation
Measured values	current, voltage
Measuring current	100 mA, 1 A and 10 A via high-current path
Electrical isolation	1,500 V (terminal/K-bus)
Special features	automatic measuring range selection
Operating temperature	0...+55 °C
Approvals	CE
Weight	approx. 70 g
Further information	www.beckhoff.com/KL3681



For availability status see Beckhoff website at: www.beckhoff.com/KL3681

Analog input | Pressure measuring

The pressure measuring terminals are divided into two groups: differential pressure measurement with the measurement between two connections and relative pressure measurement with duplicate measurement against ambient.

The Bus Terminal can be used for measurement of the pressure or also as a replacement for a pressure switch. Through the pressure value in the control unit the switching threshold for a logical linking can be stored as a parameter. Manual setting of the pressure switch in the practice is no longer necessary.

The measuring hoses can simply be connected by plugging them into a quick coupling. Normal 4 mm compressed air hoses are used.

With the direct integration of the pressure measurement into the Bus Terminal system the installation of a pressure measurement unit including its wiring can be omitted.

The pressure measurement terminals are suitable for the measurement of non-aggressive gases. Water or gases which encourage oxidation should not be allowed to get into the Bus Terminal.

1-channel differential pressure measuring terminal -100...+100 hPa

Technical data	KM3701	KM3701-0340
Technology	differential pressure measurement	
Resolution	0.1 hPa (0.1 mbar) per digit	
Number of inputs	1 (differential pressure)	
Measuring range	-100...+100 hPa (-100...+100 mbar)	up to 340 hPa (340 mbar)
Current consumption power contacts	– (no power contacts)	
Current consumpt. K-bus	typ. 15 mA	
Max. overload	500 hPa (500 mbar) differential, 5,000 hPa (5 bar) to ambient	
Medium	non-aggressive gases	
Special features	–	
Operating temperature	0...+55 °C	
Approvals	CE, UL	
Weight	approx. 95 g	
Further information	www.beckhoff.com/KM3701	

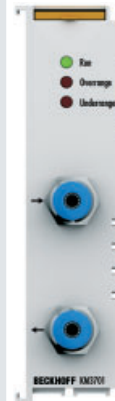

The KM3701 pressure measuring terminal enables direct measurement of pressure differences between two hose connections. The pressure difference is available in the fieldbus as a 16 bit value and can be measured between any points up to an ambient pressure of 10 bar. The status LEDs indicate proper function or errors such as over-range.

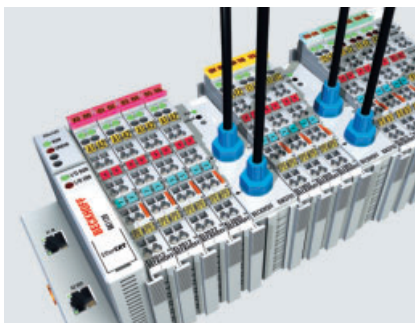

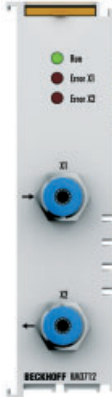
	2-channel relative pressure measuring terminal 7,500 hPa	2-channel relative pressure measuring terminal -1,000...+1,000 hPa
	KM3702	KM3712
	relative pressure measurement	
	2	2
	 <p>The KM3702 pressure measuring terminal enables direct measurement of two pressure values at the hose connections. The pressure is determined as a pressure difference to the ambiance of the KM3702 and is available in the fieldbus as a 16 bit value. The status LEDs indicate proper function or errors such as over-range.</p>	 <p>The KM3712 pressure measuring terminal enables direct measurement of two negative pressure values at the hose connections. The pressure is determined as a pressure difference to the ambiance of the KM3712 and is available in the fieldbus as a 16 bit value. The status LEDs indicate proper function or errors such as over-range.</p>
	0...7,500 hPa (7.5 bar)	-1,000...+1,000 hPa (-1...+1 bar)
	– (no power contacts)	– (no power contacts)
	typ. 15 mA	typ. 15 mA
	10,000 hPa (10 bar)	5,000 hPa (5 bar)
	non-aggressive gases	non-aggressive gases
	–	–
	0...+55 °C	0...+55 °C
	CE, UL	CE, UL
	approx. 95 g	approx. 95 g
	www.beckhoff.com/KM3702	www.beckhoff.com/KM3712

Analog output | -10...+10 V

The KL4xxx Bus Terminals provide analog signal voltages in the common standard signal range of -10 to +10 V, 0 to 10 V, 0 to 20 mA and 4 to 20 mA. Inside the terminal the field side is electrically isolated from the K-bus and enables the interconnection to the desired potential groups. The 1-channel Bus Terminals are available for application instances, in which each signal must be completely electrically isolated. An additional electrically isolated 24 V DC supply can be created by the introduction of the KL9560 power supply terminal.

The Bus Terminals of this group differ in their different resolutions of the analog/digital conversion, conversion speed and accuracy. For 1- and 2-channel Bus Terminals 1-, 2-, 3- and 4-wire sensor connections are available. 4-channel Bus Terminals can only be used with 1- and 2-wire connections.

The current output terminals 0...20 mA and 4...20 mA are fed from the 24 V DC supply and are electrically connected with it. The signal current flows from the output to ground.

Most Bus Terminals with voltage outputs are supplied from the internal K-bus. These Bus Terminals are potential-free and must be connected with the actuator through an additional ground wire. In contrast, the KL4404/08 and KL4434/38 Bus Terminals are supplied by the 24 V from the power contacts and use a power contact as a reference ground.

KL9570 | Power supply terminal
see page **601**

1-channel analog output terminal, -10...+10 V, 12 bits

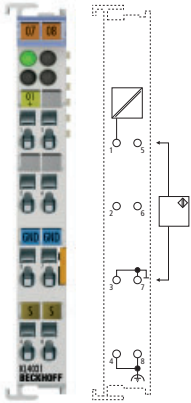
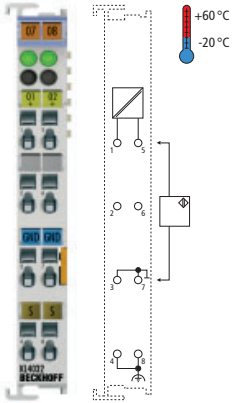

2-channel analog output terminal, -10...+10 V, 12 bits

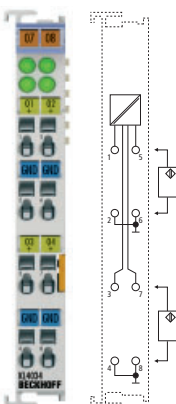
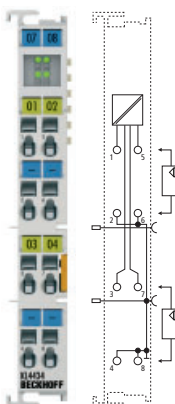
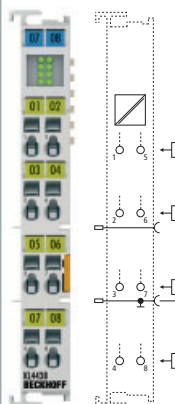
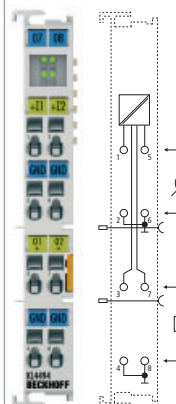
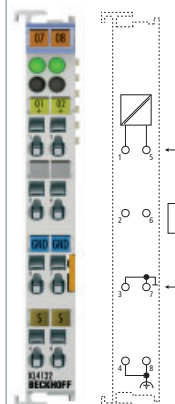
Technical data	KL4031 KS4031	KL4032 KS4032
Signal voltage	-10...+10 V	
Resolution	12 bits	
Technology	–	single-ended
Conversion time	~ 1.5 ms	~ 1.5 ms
Number of outputs	1	2
	 <p>The KL4031 analog output terminal generates signals in the range from -10 to +10 V. It combines two output channels, which have a common ground potential in one housing.</p>	 <p>The KL4032 analog output terminal generates signals in the range from -10 to +10 V. It combines two output channels, which have a common ground potential in one housing.</p>
Output error	< ±0.1 % (relative to end value)	< ±0.1 % (relative to end value)
Current consumption power contacts	– (no power contacts)	– (no power contacts)
Current consumpt. K-bus	typ. 75 mA	typ. 75 mA
Load	> 5 kΩ (short-circuit-proof)	> 5 kΩ (short-circuit-proof)
Special features	potential-free output	–
Operating temperature	0...+55 °C	-20...+60 °C
Approvals	CE, UL, Ex, GL	CE, UL, Ex, GL
Weight	approx. 85 g	approx. 85 g
Further information	www.beckhoff.com/KL4031	www.beckhoff.com/KL4032
Special terminals		KL4032-00xx
Distinguishing features		for special terminals see page 605

	4-channel analog output terminal, -10...+10 V, 12 bits	4-channel analog output terminal, -10...+10 V, 12 bits	8-channel analog output terminal, -10...+10 V, 12 bits	2-channel analog input, 2-channel analog output terminal, -10...+10 V, 12 bits	2-channel analog output terminal, -10...+10 V, 16 bits
	KL4034 KS4034	KL4434 KS4434	KL4438 KS4438	KL4494 KS4494	KL4132 KS4132
					16 bits
	single-ended	single-ended	single-ended	single-ended	single-ended
	~ 2 ms	~ 4 ms	~ 8 ms	< 2ms	~ 1.5 ms
	4	4	8	2 outputs + 2 inputs	2
					
	The KL4034 analog output terminal generates signals in the range from -10 to +10 V. It combines four output channels, which have a common ground potential in one housing.	The KL4434 analog output terminal generates signals in the range from -10 to +10 V. It combines four output channels, which have a common ground potential in one housing.	The KL4438 analog output terminal generates signals in the range from -10 to +10 V. It combines eight output channels in one housing and is thus particularly suited for space-saving use in the control cabinet. The 0 V power contact serves as the common ground potential.	The KL4494 analog output terminal combines two analog inputs and two analog outputs. The input and output channels of the Bus Terminal have a common ground potential. – input internal resistance: > 130 kΩ	The KL4132 analog output terminal generates signals in the range from -10 to +10 V. It combines two output channels, which have a common ground potential in one housing.
	< ±0.1 % (relative to end value)	< ±0.1 % (relative to end value)	< ±0.2 % (relative to end value)	< ±0.3 % (relative to end value)	< ±0.1 % (relative to end value)
	– (no power contacts)	only load	only load	only load	– (no power contacts)
	typ. 85 mA	typ. 20 mA	typ. 20 mA	typ. 70 mA	typ. 75 mA
	> 5 kΩ (short-circuit-proof)	> 5 kΩ (short-circuit-proof)	> 5 kΩ (short-circuit-proof)	> 5 kΩ (short-circuit-proof)	> 5 kΩ (short-circuit-proof)
	–	–	high packing density	input/output terminal	increased resolution
	0...+55 °C	0...+55 °C	0...+55 °C	0...+55 °C	0...+55 °C
	CE, UL, Ex, GL	CE, UL, Ex, GL	CE, UL, Ex, GL	CE, UL, Ex	CE, UL, Ex
	approx. 85 g	approx. 75 g	approx. 75 g	approx. 55 g	approx. 85 g
	www.beckhoff.com/KL4034	www.beckhoff.com/KL4434	www.beckhoff.com/KL4438	www.beckhoff.com/KL4494	www.beckhoff.com/KL4132
	KL4034-0010				KL4132-00xx
	Siemens S5 format				for special terminals see page

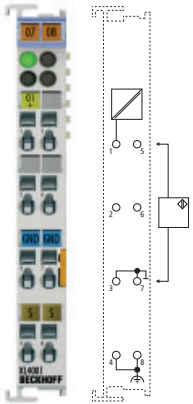
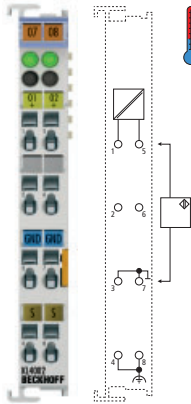
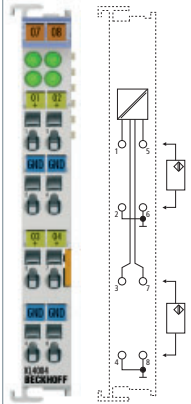
Analog output | 0...10 V

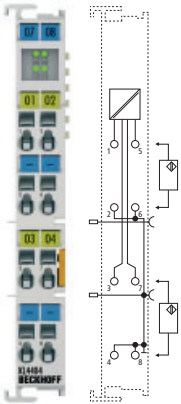
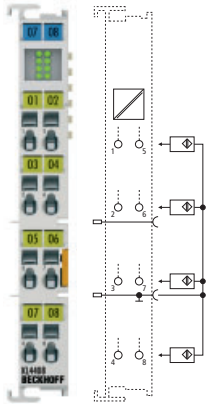
	1-channel analog output terminal, 0...10 V, 12 bits	2-channel analog output terminal, 0...10 V, 12 bits	4-channel analog output terminal, 0...10 V, 12 bits
Technical data	KL4001 KS4001	KL4002 KS4002	KL4004 KS4004
Signal voltage	0...10 V		
Resolution	12 bits		
Technology	–	single-ended	single-ended
Conversion time	~ 1.5 ms	~ 1.5 ms	~ 2 ms
Number of outputs	1	2	4
	 <p>The KL4001 analog output terminal generates signals in the range from 0 to +10 V. It combines two output channels, which have a common ground potential in one housing.</p>	 <p>The KL4002 analog output terminal generates signals in the range from 0 to +10 V. It combines two output channels, which have a common ground potential in one housing.</p>	 <p>The KL4004 analog output terminal generates signals in the range from 0 to +10 V. It combines four output channels, which have a common ground potential in one housing.</p>
Output error	< ±0.1 % (relative to end value)	< ±0.1 % (relative to end value)	< ±0.1 % (relative to end value)
Current consumption power contacts	– (no power contacts)	– (no power contacts)	– (no power contacts)
Current consumpt. K-bus	typ. 75 mA	typ. 75 mA	typ. 85 mA
Load	> 5 kΩ (short-circuit-proof)	> 5 kΩ (short-circuit-proof)	> 5 kΩ (short-circuit-proof)
Special features	potential-free output	–	–
Operating temperature	0...+55 °C	-20...+60 °C	0...+55 °C
Approvals	CE, UL, Ex	CE, UL, Ex	CE, UL, Ex
Weight	approx. 85 g	approx. 85 g	approx. 85 g
Further information	www.beckhoff.com/KL4001	www.beckhoff.com/KL4002	www.beckhoff.com/KL4004
Special terminals		KL4002-00xx	KL4004-0050
Distinguishing features		special terminals see page 605	Siemens S7 format

<p>4-channel analog output terminal, 0...10 V, 12 bits</p>	<p>8-channel analog output terminal, 0...10 V, 12 bits</p>	<p>2-channel analog output terminal, 0...10 V, 12 bits, manual/automatic operation</p>
<p>KL4404 KS4404</p>	<p>KL4408 KS4408</p>	<p>KM4602</p>
<p style="background-color: #e0e0e0; text-align: center;"> </p>		
<p>single-ended</p>	<p>single-ended</p>	<p>single-ended</p>
<p>~ 4 ms</p>	<p>~ 8 ms</p>	<p>~ 1.5 ms</p>
<p>4</p>	<p>8</p>	<p>2</p>
<div style="display: flex; align-items: center;">  <div style="margin-left: 20px;"> <p>The KL4404 analog output terminal generates signals in the range from 0 to +10 V. It combines four output channels, which have a common ground potential in one housing.</p> </div> </div>	<div style="display: flex; align-items: center;">  <div style="margin-left: 20px;"> <p>The KL4408 analog output terminal generates signals in the range from 0 to +10 V. It combines eight output channels in one housing and is thus particularly suited to space-saving use in the control cabinet. The 0 V power contact serves as the common ground potential.</p> </div> </div>	<div style="display: flex; align-items: center;">  <div style="margin-left: 20px;"> <p>The analog KM4602 output terminal has two potential-free analog 0...10 V outputs. Both are connected internally to common ground. For each channel a switch enables selection of automatic or manual mode. In automatic mode, an analog value is issued depending on the process data. With the manual switch settings, the value set via the potentiometer is applied to the output. For manual mode a 24 V supply is required for the Bus Coupler. The switch state can be read by the controller.</p> </div> </div>
<p>< ±0.1 % (relative to end value) only load</p>	<p>< ±0.2 % (relative to end value) only load</p>	<p>< ±0.1 % (relative to end value) – (no power contacts)</p>
<p>typ. 20 mA > 5 kΩ (short-circuit-proof)</p>	<p>typ. 20 mA > 5 kΩ (short-circuit-proof)</p>	<p>typ. 75 mA > 5 kΩ (short-circuit-proof)</p>
<p>– 0...+55 °C</p>	<p>high packing density 0...+55 °C</p>	<p>manual/automatic operation 0...+55 °C</p>
<p>CE, UL, Ex, GL approx. 75 g</p>	<p>CE, UL, Ex, GL approx. 75 g</p>	<p>CE approx. 85 g</p>
<p>www.beckhoff.com/KL4404</p>	<p>www.beckhoff.com/KL4408</p>	<p>www.beckhoff.com/KM4602</p>

Analog output | 0...20 mA

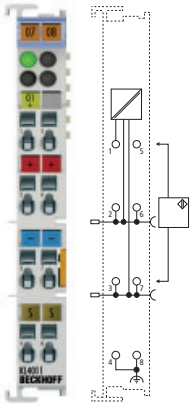
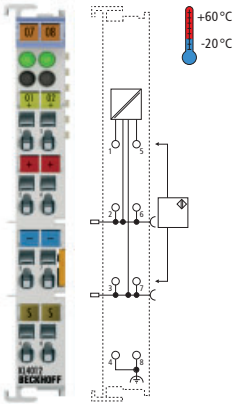
	1-channel analog output terminal, 0...20 mA, 12 bits	2-channel analog output terminal, 0...20 mA, 12 bits
Technical data	KL4011 KS4011	KL4012 KS4012
Signal current	0...20 mA	
Resolution	12 bits	
Technology	single-ended	single-ended
Conversion time	~ 1.5 ms	~ 1.5 ms
Number of outputs	1	2
	 <p>The KL4011 analog output terminal generates analog output signals in the range from 0 to 20 mA.</p>	 <p>The KL4012 analog output terminal generates signals in the range from 0 to 20 mA. It combines two output channels, which have a common ground potential with the 24 V DC supply, in one housing. The output stages are powered by the 24 V DC supply.</p>
Output error	< ±0.1 % (relative to end value)	< ±0.1 % (relative to end value)
Current consumption power contacts	typ. 30 mA + load	typ. 50 mA + load
Current consumpt. K-bus	typ. 60 mA	typ. 60 mA
Load	< 500 Ω	< 500 Ω
Power supply	24 V DC via power contacts (alternative 15 V DC with power supply terminal KL9515)	24 V DC via power contacts (alternative 15 V DC with power supply terminal KL9515)
Special features	–	–
Operating temperature	0...+55 °C	-20...+60 °C
Approvals	CE, UL, Ex, GL	CE, UL, Ex, GL
Weight	approx. 80 g	approx. 80 g
Further information	www.beckhoff.com/KL4011	www.beckhoff.com/KL4012
Special terminals		KL4012-00xx
Distinguishing features		special terminals see page 605

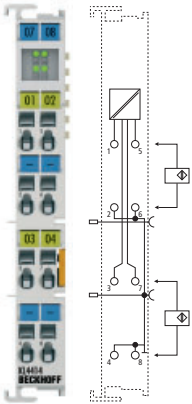
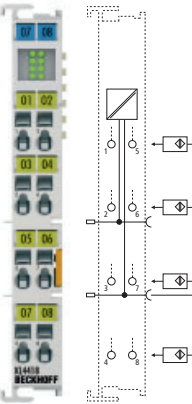
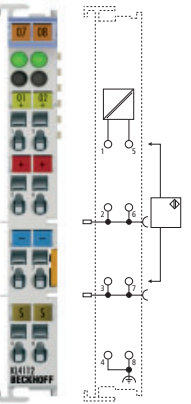
<p>4-channel analog output terminal, 0...20 mA, 12 bits</p>	<p>8-channel analog output terminal, 0...20 mA, 12 bits</p>	<p>2-channel analog output terminal, 0...20 mA, 15/16 bits</p>
<p>KL4414 KS4414</p>	<p>KL4418 KS4418</p>	<p>KL4112 KS4112</p>
<p>single-ended</p>		<p>15 bit, configurable to 16 bit</p>
<p>~ 4 ms</p>	<p>~ 8 ms</p>	<p>~ 3.5 ms</p>
<p>4</p>	<p>8</p>	<p>2</p>
 <p>The KL4414 analog output terminal generates signals in the range from 0 to 20 mA. It combines four channels, which have a common ground potential in one housing. The output stages are powered by the 24 V DC supply.</p>	 <p>The KL4418 analog output terminal generates signals in the range from 0 to 20 mA. It combines eight output channels in one housing and is thus particularly suited to space-saving use in the control cabinet. The 0 V power contact serves as the common ground potential.</p>	 <p>The KL4112 analog output terminal generates signals in the range from 0 to 20 mA. It combines two output channels, which have a common ground potential with the 24 V DC supply, in one housing. The output stages are powered by the 24 V DC supply.</p>
<p>< ±0.1 % (relative to end value) typ. 60 mA + load</p>	<p>< ±0.2 % (relative to end value) typ. 60 mA + load</p>	<p>< ±0.1 % (relative to end value) typ. 50 mA + load</p>
<p>typ. 20 mA</p>	<p>typ. 20 mA</p>	<p>typ. 60 mA</p>
<p>< 350 Ω (short-circuit-proof)</p>	<p>< 150 Ω (short-circuit-proof)</p>	<p>< 500 Ω</p>
<p>24 V DC via power contacts (alternative 15 V DC with power supply terminal KL9515)</p>	<p>24 V DC via power contacts (alternative 15 V DC with power supply terminal KL9515)</p>	<p>24 V DC via power contacts (alternative 15 V DC with power supply terminal KL9515)</p>
<p>–</p>	<p>high packing density</p>	<p>increased resolution</p>
<p>0...+55 °C</p>	<p>0...+55 °C</p>	<p>0...+55 °C</p>
<p>CE, UL, Ex, GL</p>	<p>CE, UL, Ex, GL</p>	<p>CE, UL, Ex</p>
<p>approx. 75 g</p>	<p>approx. 75 g</p>	<p>approx. 80 g</p>
<p>www.beckhoff.com/KL4414</p>	<p>www.beckhoff.com/KL4418</p>	<p>www.beckhoff.com/KL4112</p>
<p>KL4112-00xx</p>		<p>special terminals see page</p>

Analog output | 4...20 mA

	1-channel analog output terminal, 4...20 mA, 12 bits	2-channel analog output terminal, 4...20 mA, 12 bits
--	---	---

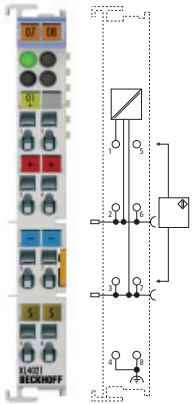
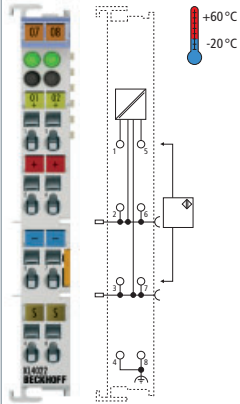
Technical data	KL4021 KS4021	KL4022 KS4022
Signal current	4...20 mA	
Resolution	12 bits	
Technology	single-ended	single-ended
Conversion time	~ 1.5 ms	~ 1.5 ms
Number of outputs	1	2
	 <p>The KL4021 analog output terminal generates analog output signals in the range from 4 to 20 mA.</p>	 <p>The KL4022 analog output terminal generates signals in the range from 4 to 20 mA. It combines two output channels, which have a common ground potential with the 24 V DC supply, in one housing. The output stages are powered by the 24 V DC supply.</p>
Output error	< ±0.1 % (relative to end value)	< ±0.1 % (relative to end value)
Current consumption power contacts	typ. 30 mA + load	typ. 50 mA + load
Current consumpt. K-bus	typ. 60 mA	typ. 60 mA
Load	< 500 Ω	< 500 Ω
Power supply	24 V DC via power contacts (alternative 15 V DC with power supply terminal KL9515)	24 V DC via power contacts (alternative 15 V DC with power supply terminal KL9515)
Special features	–	–
Operating temperature	0...+55 °C	-20...+60 °C
Approvals	CE, UL, Ex, GL	CE, UL, Ex, GL
Weight	approx. 80 g	approx. 80 g
Further information	www.beckhoff.com/KL4021	www.beckhoff.com/KL4022
Special terminals		KL4022-00xx
Distinguishing features		special terminals see page 605

Bus Terminal

578

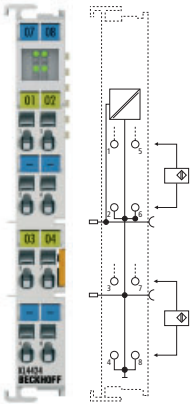
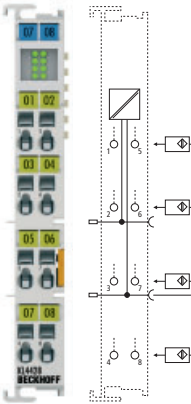
<p>4-channel analog output terminal, 4...20 mA, 12 bits</p>	<p>8-channel analog output terminal, 4...20 mA, 12 bits</p>
<p>KL4424 KS4424</p>	<p>KL4428 KS4428</p>
<p style="background-color: #e0e0e0;"> </p>	
<p>single-ended</p>	<p>single-ended</p>
<p>~ 4 ms</p>	<p>~ 8 ms</p>
<p>4</p>	<p>8</p>
<div style="display: flex; align-items: center;">  </div> <p>The KL4424 analog output terminal generates signals in the range from 4 to 20 mA. It combines four channels, which have a common ground potential in one housing. The output stages are powered by the 24 V DC supply.</p>	<div style="display: flex; align-items: center;">  </div> <p>The KL4428 analog output terminal generates signals in the range from 4 to 20 mA. It combines eight output channels in one housing and is thus particularly suited to space-saving use in the control cabinet. The 0 V power contact serves as the common ground potential.</p>
<p>< ±0.1 % (relative to end value)</p>	<p>< ±0.2 % (relative to end value)</p>
<p>typ. 60 mA + load</p>	<p>typ. 60 mA + load</p>
<p>typ. 20 mA</p>	<p>typ. 20 mA</p>
<p>< 350 Ω (short-circuit-proof)</p>	<p>< 150 Ω (short-circuit-proof)</p>
<p>24 V DC via power contacts (alternative 15 V DC with power supply terminal KL9515)</p>	<p>24 V DC via power contacts (alternative 15 V DC with power supply terminal KL9515)</p>
<p>–</p>	<p>increased packing density</p>
<p>0...+55 °C</p>	<p>0...+55 °C</p>
<p>CE, UL, Ex, GL</p>	<p>CE, UL, Ex, GL</p>
<p>approx. 75 g</p>	<p>approx. 75 g</p>
<p>www.beckhoff.com/KL4424</p>	<p>www.beckhoff.com/KL4428</p>
<p style="background-color: #0070c0; color: white;"> </p>	

Position measurement | SSI encoder interface

The KL5001 SSI interface terminal enables the direct connection of an SSI encoder that is powered via the SSI interface. The interface circuit generates a pulse for reading the encoder and makes the incoming data stream available to the controller as a data word in the process image. Various operating modes, transmission frequencies and bit widths can be permanently stored in a control register. A screen can be connected via the KL9195 shield terminal.

The KL5051 bidirectional SSI interface terminal enables the connection of digital servo drives. The encoder is powered via the SSI interface, which consists of two logic channels. The first channel is used for the positioning of the drive, while the second channel is used to set releases, to transmit parameter data and to read status information and parameter values. The 5 V DC supply voltage can be generated with the KL9505 power supply terminal and fed into the power contacts.

KL9195 | Shield terminal

see page [595](#)

KL9505 | Power supply terminal

see page [600](#)

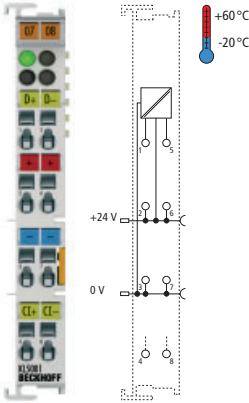
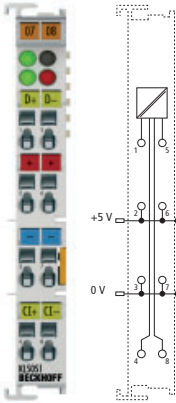
	SSI encoder interface	Bidirectional SSI encoder interface
Technical data	KL5001 KS5001	KL5051 KS5051
Technology	SSI encoder interface	
Data direction	read	bidirectional
Number of channels	1 encoder interface	1 encoder interface
Encoder connection	binary input: D+, D-, binary output: Cl+, Cl-	binary input: D+, D-, binary output: Cl+, Cl-
		
Power supply	24 V DC via power contacts	5 V DC via power contacts (KL9505)
Current consumption power contacts	typ. 20 mA + load	no data
Current consumpt. K-bus	typ. 25 mA	typ. 75 mA
Signal input	difference signal (RS422)	difference signal (RS422)
Signal output	difference signal (RS422)	difference signal (RS422)
Encoder supply	24 V DC via power contacts	5 V DC
Data transfer rates	variable up to 1 MHz, 250 kHz default	1 MHz
Special features	–	bidirectional
Operating temperature	-20...+60 °C	0...+55 °C
Approvals	CE, UL, Ex	CE, UL, Ex
Weight	approx. 60 g	approx. 80 g
Further information	www.beckhoff.com/KL5001	www.beckhoff.com/KL5051

Position measurement | Incremental encoder interface

The KL5121 can be used to implement a linear path control. The terminal reads an incremental signal supplied by an incremental encoder or a pulse generator and switches the outputs at predefined counter states. The counter states can be transmitted to the terminal by the higher-level automation device in the form of a table. The position is registered with the latch input, which is activated/deactivated by the gate input. Up to four 24 V outputs can be switched. The LEDs indicate the states of the signals at the various inputs and outputs.

The KL5121 is particularly suitable for applications that are dependent on a short response time. The K-Bus cycle time, the field-bus runtime and the processing speed of the controller are of no importance for the fast and accurate processing of positional data, since the Bus Terminal always switches the outputs with a constant time delay, irrespective of the control environment.

Incremental encoder interface
with programmable outputs

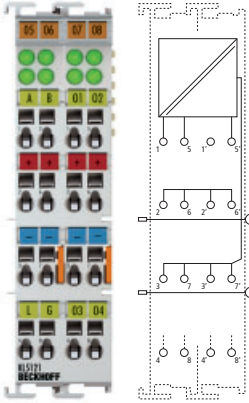
Technical data	KL5121 KS5121
Technology	incremental encoder interface with programmable outputs
Number of channels	1 incremental encoder + 4 outputs
Encoder connection	A, B, latch, gate
	
Power supply	24 V DC (-15 %/+20 %)
Current consumption power contacts	typ. 30 mA + load
Current consumpt. K-bus	typ. 30 mA
Encoder operating voltage	24 V DC
Counter	16 bits, binary
Limit frequency	1 million increments/s (with 4-fold evaluation)
Output voltage	24 V
Output current	0.5 A
Switching times	< 100 µs
Special features	electronic camshaft controller
Operating temperature	0...+55 °C
Approvals	CE, UL, Ex
Weight	approx. 60 g
Further information	www.beckhoff.com/KL5121

Position measurement | Incremental encoder interface

The KL5101 Bus Terminal processes differential signals according to the RS422/RS485 standard. This transmission type is particularly resistant to interference and is suitable for high transmission frequencies. The KL5111, KL5151 and KL5152 Bus Terminals have a single-ended input and are simple to wire up. The signal frequencies from less time-critical applications can be processed using these terminals.

All incremental encoder terminals use a quadrature decoder. Gate and latch inputs enable pre-processing in the Bus Terminal in order to be able to transfer positional values to the controller exactly upon an external event and thus support the referencing of a drive.

The KL5101 and KL5111 make a period duration measurement available with a resolution of 200 ns. Rotary speeds can thus be determined directly, since a calculation of the speed by means of position differences in the controller is in many cases not accurate enough due to jitter.

The KL5152 contains two encoders and provides a particularly inexpensive solution for a large number of channels if gate and latch functions are not needed.

The LEDs on the Bus Terminals indicate the states of the input signals for better diagnosis.

1-channel incremental encoder interface,
16 bits, differential inputs, RS485

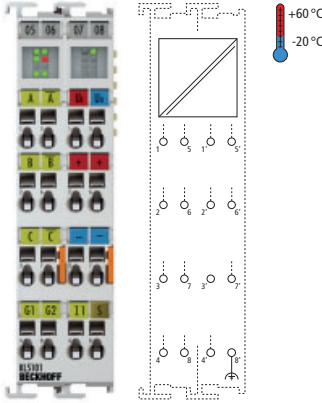
Technical data	KL5101 KS5101
Technology	incremental encoder interface (RS485)
Number of channels	1 incremental encoder + 1 input
Encoder connection	A, A (inv), B, B (inv), zero, zero (inv), difference signal (RS485); status input
	 <p>The KL5101 terminal is an interface for the direct connection of incremental encoders with difference signal (RS485) or with single inputs. A 16 bit counter with a quadrature decoder and a 16 bit latch for the zero pulse can be read, set or enabled. Interval measurement with a resolution of 200 ns is possible. The G2 input allows the counter to be halted (high = stop). The value is read with a rising edge at G1.</p>
Power supply	24 V DC (-15 %/+20 %)
Current consum. pow.cont.	– (no power contacts)
Current consumpt. K-bus	typ. 60 mA
Encoder operating voltage	5 V DC
Encoder output current	0.5 A
Counter	16 bits, binary
Limit frequency	4 million increments/s (with 4-fold evaluation)
Quadrature decoder	1-, 2-, or 4-fold evaluation
Zero-pulse latch	16 bits
Commands	read, set, enable
Special features	–
Operating temperature	-20...+60 °C
Approvals	CE, UL, Ex
Weight	approx. 85 g
Further information	www.beckhoff.com/KL5101
Special terminals	
Distinguishing features	

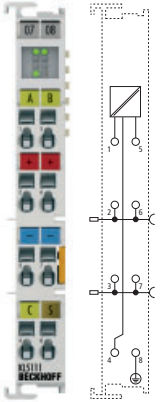
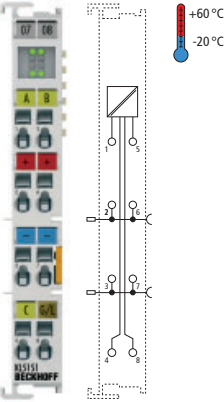
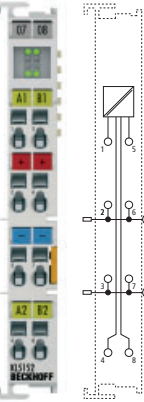
1-channel incremental encoder interface, 16 bits, single-ended, 24 V DC	1-channel incremental encoder interface, 32 bits, single-ended, 24 V DC	2-channel incremental encoder interface, 32 bits, single-ended, 24 V DC
KL5111 KS5111	KL5151 KS5151	KL5152 KS5152
incremental encoder interface, 24 V DC		
1 incremental encoder	2 incremental encoders	
A, B, C; 24 V (low: < 3 V, high: > 18 V)	A, B, C, gate/latch, 24 V	A1, B1, A2, B2, 24 V
 <p>The KL5111 Bus Terminal is an interface for the direct connection of 24 V incremental encoders. A 16 bit counter with a quadrature decoder and a 16 bit latch for the zero pulse can be read, set or enabled. The state of the counter is transmitted quickly and securely to the PC, PLC or CNC over the fieldbus. Interval measurement with a resolution of 200 ns is possible.</p>	 <p>The KL5151 Bus Terminal is an interface with 24 V inputs for the direct connection of incremental encoders. A 32 bit counter with a quadrature decoder and a 32 bit latch for the zero pulse can be read, set or enabled. The KL5151 inputs can optionally be used as single or two-counter inputs.</p>	 <p>The KL5152 Bus Terminal is an interface with 24 V inputs for the direct connection of incremental encoders. Two 32 bit counters with quadrature decoders can be read or set.</p>
24 V DC (-15 %/+20 %)	24 V DC (-15 %/+20 %)	24 V DC (-15 %/+20 %)
–	–	–
typ. 40 mA	typ. 40 mA	typ. 40 mA
24 V DC	24 V DC	24 V DC
–	–	–
16 bits, binary	32 bits, binary	32 bits, binary
1 million increments/s (with 4-fold evaluation)	400,000 increments/s (with 4-fold evaluation)	400,000 increments/s (with 4-fold evaluation)
4-fold evaluation	4-fold evaluation	4-fold evaluation
16 bits	32 bits	–
read, set, enable	read, set, enable	read
–	–	–
0...+55 °C	-20...+60 °C	0...+55 °C
CE, UL, Ex	CE, UL, Ex	CE, UL, Ex
approx. 60 g	approx. 50 g	approx. 50 g
www.beckhoff.com/KL5111	www.beckhoff.com/KL5151	www.beckhoff.com/KL5152
KL5111-00xx	KL5151-0021	
for special terminals see page 605	incremental encoder 1 x 32 bits A, B, capture input and 1 driver output 24 V, 0.5 A	

Communication | Serial interfaces

The KL60xx serial interfaces enable the connection of devices with RS232 or RS422/RS485 interfaces to the control level. The devices connected to the Bus Terminals communicate via the coupler and the network with the automation device. The active communication channel operates independently of the higher-level bus system in full duplex mode at up to 115.2 kbaud. This way, any desired number of serial interfaces can be used in the application without having to consider structural restrictions in the control device. The serial interface can be positioned close to the place of use, this way reducing the necessary cable lengths.

The RS232 interface enables high resistance to interference by means of electrically isolated signals, which in the case of the KL6021 is additionally supported by differential signal transmission according to RS422.

Serial interface RS232,
up to 19,200 baud

Serial interface RS232,
up to 115.2 kbaud

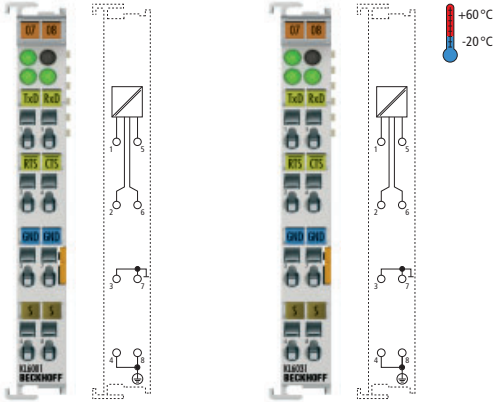
Technical data	KL6001 KS6001	KL6031 KS6031
Technology	RS232	
Data transfer rates	1,200...19,200 baud; default: 9,600 baud, 8 data bits, no parity and one stop bit	4,800...115,200 baud; default: 9,600 baud, 8 data bits, no parity and one stop bit
Data transfer channels	2 (1/1), TxD and RxD, full duplex	2 (1/1), TxD and RxD, full duplex
		
	<p>The KL6001 and KL6031 serial interfaces allow devices with an RS232 interface to be connected. The interface operates in conformity with the CCITT V.28/DIN 66 259-1 standards. The active communication channel operates independently of the higher-level bus system in full duplex mode at up to 19,200 baud (KL6001) or 115.2 kbaud (KL6031). The RS232 interface guarantees high immunity to interference through electrically isolated signals.</p>	
Data buffer	128 bytes receive buffer, 16 bytes transmit buffer	1024 bytes receive buffer, 128 bytes transmit buffer
Current consumption power contacts	– (no power contacts)	
Current consumpt. K-bus	typ. 55 mA	typ. 55 mA
Cable length	max. 15 m	max. 15 m
Line impedance	–	
Special features	high interference immunity, electrically isolated signals	high interference immunity, electrically isolated signals
Operating temperature	0...+55 °C	-20...+60 °C
Approvals	CE, UL, Ex	CE, UL, Ex
Weight	approx. 80 g	approx. 80 g
Further information	www.beckhoff.com/KL6001	www.beckhoff.com/KL6031
Special terminals	KL6001-0020	
Distinguishing features	standard format 5 bytes of user data	

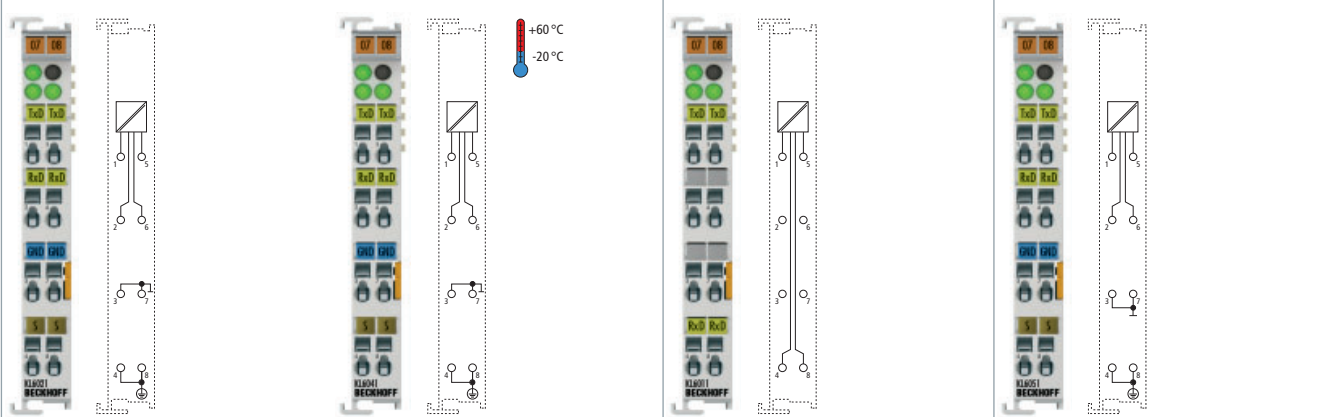
Serial interface RS422/RS485, up to 19,200 baud	Serial interface RS422/RS485, up to 115.2 kbaud	Serial interface TTY, 20 mA current loop	Data exchange terminal with serial interface
KL6021 KS6021	KL6041 KS6041	KL6011 KS6011	KL6051 KS6051
RS422/RS485	RS422/RS485	TTY	2 x RS422
1,200...19,200 baud; default: 9,600 baud, 8 data bits, no parity and one stop bit	4,800...115,200 baud; default: 9,600 baud, 8 data bits, no parity and one stop bit	1,200...19,200 baud; default: 9,600 baud, 8 data bits, no parity and one stop bit	62,500 baud, 32 bits bidirectional data exchange between two KL6051
TxD and RxD, full/half duplex	TxD and RxD, full/half duplex	2 (1/1), TxD and RxD, full duplex	TxD and RxD, full duplex
			
<p>The KL6021 and KL6041 serial interfaces allow devices with an RS422 or RS485 interface to be connected. The active communication channel operates independently of the higher-level bus system in full or half duplex mode at up to 19,200 baud (KL6021) or 115.2 kbaud (KL6041). The transmission of differential signals conforms to RS422 and guarantees high immunity to interference through electrically isolated signals.</p>		<p>The KL6011 serial interface allows devices with a 20 mA current loop to be connected. The interface operates passively. The current interface (TTY) guarantees high immunity to interference through electrically isolated signals with injected current.</p> <p>Under the terminal's default setting, 32 inputs and 32 outputs are transferred between the fieldbus systems. The time to exchange the data is about 5 ms for 32 bits of I/O. The exchange of data with the Bus Coupler is indicated by the run LED. The TxD and RxD LEDs indicate the state of the signal transmission.</p>	
128 bytes receive buffer, 16 bytes transmit buffer – (no power contacts)	1024 bytes receive buffer, 128 bytes transmit buffer – (no power contacts)	128 bytes receive buffer, 16 bytes transmit buffer – (no power contacts)	32 bit bidirectional – (no power contacts)
typ. 65 mA	typ. 65 mA	typ. 55 mA	typ. 65 mA
approx. 1,000 m twisted pair	approx. 1,000 m twisted pair	max. 1,000 m twisted pair	approx. 1,000 m twisted pair
120 Ω	120 Ω	–	120 Ω
high interference immunity, electrically isolated signals	high interference immunity, electrically isolated signals	2 x 20 mA bit transfer	automatic data exchange
0...+55 °C	-20...+60 °C	0...+55 °C	0...+55 °C
CE, UL, Ex	CE, UL, Ex	CE, UL, Ex	CE, UL, Ex
approx. 60 g	approx. 60 g	approx. 60 g	approx. 60 g
www.beckhoff.com/KL6021	www.beckhoff.com/KL6041	www.beckhoff.com/KL6011	www.beckhoff.com/KL6051
KL6021-002x special terminals see 605		KL6011-0020 standard format 5 bytes of user data	

Communication | AS-Interface

The AS-Interface master terminal is an extended master according to the M3 profile and enables the direct connection of AS-Interface slaves. The AS-compliant interface supports digital and analog slaves with the versions 2.0 and 2.1, safety slaves and slaves with Combined Transaction Type 1 (profile S-7.3 and 7.4). Process data exchange, parameterisation and the diagnosis are fieldbus-independent. Together with the various Bus Couplers, the KL6201 or the KL6211 represents a universal AS-Interface/fieldbus gateway. Together with the BK3120, the PROFIBUS DP V1 services can be used for communication with the KL6201 or the KL6211. Unlike the KL6201 AS-Interface master terminal, the KL6211 features power contacts. This enables direct connection to the AS-Interface supply via the KL9520 AS-Interface potential feed terminal or the KL9528 power supply terminal.

KL9520, KL9528 | AS-Interface system terminals see page [602](#)

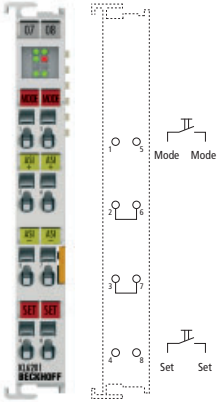
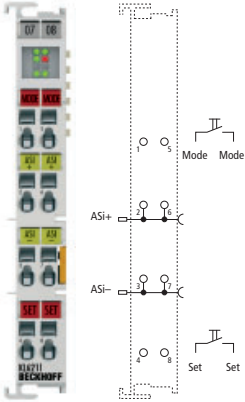
	AS-Interface master terminal	AS-Interface master terminal with power contacts
Technical data	KL6201 KS6201	KL6211 KS6211
Technology	AS-Interface	
Cycle time	max. 5 ms (31 devices)	
Number of channels	1	1
		
AS-Interface versions	V 2.0 and V 2.1	V 2.0 and V 2.1
Current consumption power contacts	– (no power contacts)	typ. 60 mA + load
Current consumption K-bus	typ. 55 mA (K-bus), approx. 60 mA (AS-Interface)	typ. 55 mA (K-bus), approx. 60 mA (AS-Interface)
Number of slaves	31 for V 2.0, 62 for V 2.1	31 for V 2.0, 62 for V 2.1
Slave types	digital and analog	
AS-Interface address assignment	via configuration or automatic	
Diagnostics	power failure, slave failure, parameterisation fault	
Connection	2 lines via spring force technology	
Operating temperature	0...+55 °C	
Approvals	CE	
Weight	approx. 55 g	
Further information	www.beckhoff.com/KL6201 / www.beckhoff.com/KL6211	
Special terminals	KL6201-0010	
Distinguishing features	for special terminals see page 607	

Communication | Wireless data exchange

The KM6551 terminal module is a data exchange unit for radio technology. The KM module is based on the IEEE802.15.4 standard. Data are exchanged or transferred via radio between two stand-alone control units, independent of the higher-level fieldbus. The outdoor range between two KM6551 units can be up to 300 m.

The data exchange module has a reverse SMA plug (Straight Medium Adapter) for connection of various radio antennas. The free choice of antenna enables adaptation to the respective environment. Status and data exchange are displayed via LEDs, thereby offering fast and simple diagnostics. A library is available for using the KM6551 module with TwinCAT.

Option 1 | Data exchange peer-to-peer

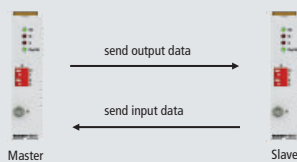

Option 2 | Data exchange up to max. 7 devices

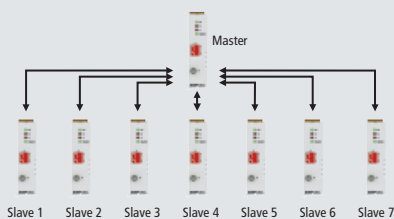

Option 3 | Broadcast up to x devices

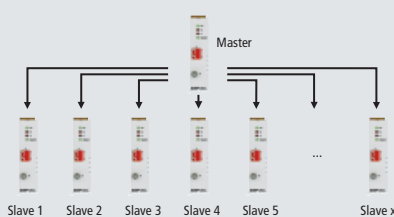



Wireless data exchange terminal

Technical data	KM6551	
Technology	wireless data exchange	
Data transfer rates	250 kbit	
Number of channels	1 radio connection	
Protocol	IEEE 802.15.4	
Current consumption power contacts	– (no power contacts)	
Current consumpt. K-bus	typ. 135 mA	
Frequency band	2.4 GHz	
Antenna connection	reverse SMA plug (RP-SMA)	
Operating temperature	0...+55 °C	
Approvals	CE, UL	
Weight	approx. 85 g	
Further information	www.beckhoff.com/KM6551	
Accessories		
ZS6200-0400	omni-directional antenna 4 dBi	614
ZS6100-0900	directional antenna 9 dBi	614
ZS6201-0410	rod antenna 4 dBi	615
ZS6201-0500	rod antenna 5 dBi	615
ZS6100-1800	directional antenna 18 dBi	615
ZK6000-0102-0020	coaxial cable, 50 Ω impedance, 2 m	615
ZK6000-0102-0040	coaxial cable, 50 Ω impedance, 4 m	615

Communication | EnOcean, IO-Link, EIB

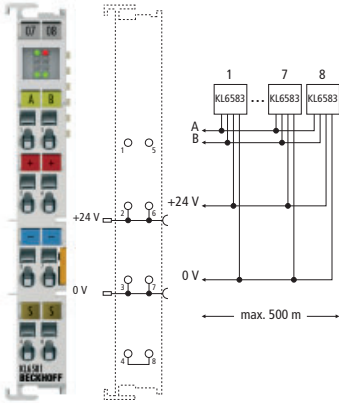

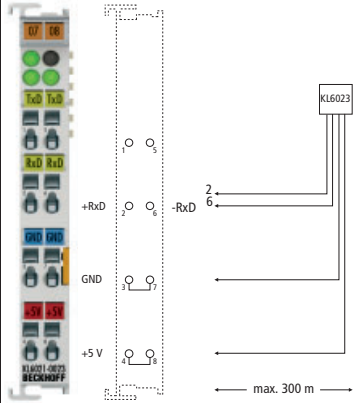
	EnOcean master terminal	EnOcean transmitter and receiver	Serial interface for processing signals from the KL6023 wireless adapter with EnOcean radio technology
Technical data	KL6581	KL6583	KL6021-0023
Technology	EnOcean		EnOcean
Data transfer rates	125 kbaud	–	9,600 baud
Number of channels	1	–	1
	 <p>The bidirectional EnOcean technology receives signals from battery-less sensors or transmits data to actuators. With a radio signal range of 30 m, the wiring of buildings can be simplified significantly. The KL6581 EnOcean master terminal is the link between up to eight KL6583 EnOcean transmitter and receiver modules and the application.</p>	 <p>The KL6583 EnOcean module enables EnOcean data to be transmitted and received. An antenna is integrated in the device. The KL6583 module is supplied with 24 V and offers a bus connection to the KL6581 EnOcean master terminal. The KL6583 is addressed via an address selection switch. Up to eight KL6583 modules can be connected to a KL6581.</p>	 <p>The KL6021-0023 serial interface enables connection of a KL6023 wireless adapter. It processes the RS485 signals of the wireless adapter.</p>
Nominal voltage	24 V DC (-15 %/+20 %)	24 V DC (via KL6581)	–
Current consumpt. pow.cont.	typ. 20 mA + load	typ. 20 mA (24 V DC)	– (no power contacts)
Current consumpt. K-bus	typ. 60 mA	–	typ. 65 mA
Cable length	max. 500 m	max. 500 m	max. 300 m
Connection	2 x 2-wires directly at the KL6583 (connection of max. 8 KL6583)	2 x 2-wires directly at the KL6581 Bus Terminal	2 x 2-wires directly at the KL6023 EnOcean module
Data transfer standard	–	bidirectional	–
Frequency band	–	868.35 MHz	–
Data transfer range	–	300 m in the free field, 30 m within buildings	–
Special features	up to 8 KL6583 EnOcean transmitter and receiver modules	connection to KL6581 EnOcean master	high interference immunity, electrically isolated signals
Operating temperature	0...+55 °C	0...+55 °C	0...+55 °C
Approvals	CE	CE	CE
Weight	approx. 85 g	approx. 90 g	approx. 60 g
Further information	www.beckhoff.com/KL6581	www.beckhoff.com/KL6583	www.beckhoff.com/KL6021

IO-Link

EIB

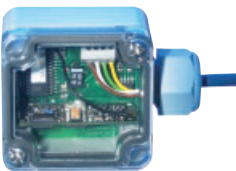
Wireless adapter for EnOcean radio technology
KL6023
–
–

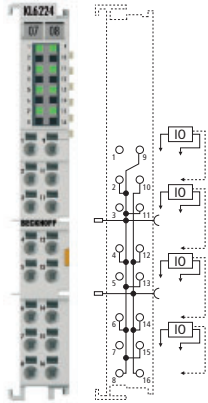
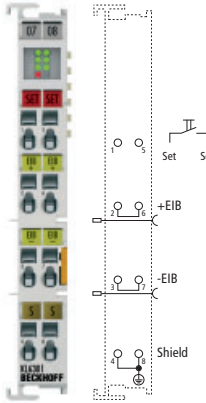
The KL6023 Wireless Adapter receives signals from battery-less sensors with EnOcean technology. These signals are converted by the Wireless Adapter to a RS485 signal and directly processed further by the KL6021-0023 serial Bus Terminal. The system does not limit the number of transmitters per receiver unit. In practice, between 25 and 100 transmitters per receiver are used.
via KL6021-0023
–
–
max. 300 m
2 x 2-wires directly at the KL6021-0023 Bus Terminal
unidirectional
868.35 MHz
300 m in the free field, 30 m within buildings
connection to KL6021-0023 serial interface
0...+55 °C
CE
approx. 55 g
www.beckhoff.com/KL6023

	IO-Link master terminal	EIB Bus Terminal
Technical data	i KL6224	KL6301 KS6301
Technology	IO-Link	EIB
Data transfer rates	4.8 kbaud, 38.4 kbaud and 230.4 kbaud	9,600 baud
Number of channels	4	1
		
	The IO-Link terminal enables connection of up to four IO-Link devices. A point-to-point connection is used between the terminal and the device. The terminal is parameterised via the master. 2-wire and 3-wire connections are supported. Additional 24 V and 0 V connection points can be realised via the KL918x potential distributor terminal.	The KL6301 EIB Bus Terminal is integrated in an EIB network and can receive/transmit data from/to other EIB devices. The Bus Terminal is commissioned or configured via TwinCAT function blocks. Several KL6301 can be used with a single Bus Coupler or a Bus Terminal Controller. Up to 256 group addresses can be received; sending is only limited by the application.
Nominal voltage	24 V DC (-15 %/+20 %)	24 V DC (-15 %/+20 %)
Current consumption power contacts	no data	–
Current consumpt. K-bus	typ. 85 mA	typ. 55 mA
Data transfer standard	–	twisted pair (TP)
Bus access	–	CSMA/CA
Special features	–	TwinCAT library available
Operating temperature	0...+55 °C	0...+55 °C
Approvals	CE	CE, Ex
Weight	approx. 60 g	approx. 85 g
Further information	www.beckhoff.com/KL6224	www.beckhoff.com/KL6301

i For availability status see Beckhoff website at: www.beckhoff.com/KL6224

Communication | LON, MP-Bus, DALI

LON

MP-BUS[®]
MP-BUS COMPATIBLE

DALI

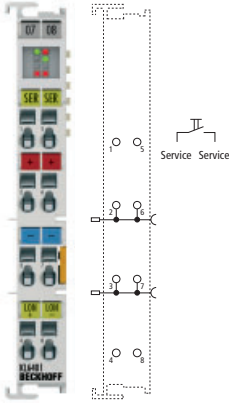
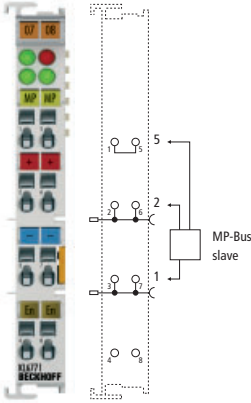
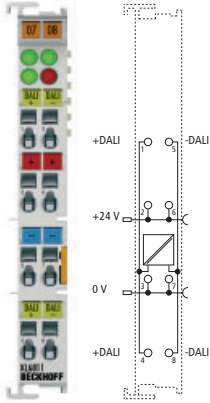
	LON Bus Terminal	MP-Bus master terminal	DALI/DSI master and power supply terminal
Technical data	KL6401 KS6401	KL6771 KS6771	KL6811 KS6811
Technology	LON	MP-Bus	DALI/DSI
Data transfer rates	78 kbit/s	1,200 baud	
Number of channels	1	1	1
	 <p>The KL6401 LON Bus Terminal enables direct connection of LON devices. Several KL6401 can be used with a single Bus Coupler or a Bus Terminal Controller. The KL6401 supports 62 SNVTs. All SNVT types can be configured as input or output variable via the KS2000 software. The KS2000 software generates an XIF file that is integrated in a LON tool.</p>	 <p>The MP-Bus master terminal enables direct connection of MP-Bus slave devices. Up to sixteen field devices, eight drives and eight sensors can be connected to the KL6771. The Bus Terminal is configured and commissioned via TwinCAT function blocks. Several KL6771 terminals can be connected to the same Bus Coupler or Bus Terminal Controller.</p>	 <p>The KL6811 enables the connection of up to 64 DALI slaves. The KS2000 software enables simple configuration via a PC that is directly coupled with the Bus Coupler via an RS232 interface or via the fieldbus. The integrated power supply unit generates an electrically isolated 24 V DC output voltage. No further components are required for the operation of the DALI slaves. The KL6811 operates fieldbus-independent.</p>
Nominal voltage	24 V DC (-15 %/+20 %)	24 V DC (-15 %/+20 %)	24 V DC (-15 %/+20 %)
Current consum. pow.cont.	only load	typ. 10 mA + load	typ. 30 mA + load
Current consumpt. K-bus	typ. 55 mA	typ. 55 mA	typ. 55 mA
Data transfer standard	FTT-10, LPT	MP-Bus	DALI
Special features	15 devices; TwinCAT library available	8 drives/sensors; TwinCAT library available	connection of up to 64 DALI slaves; TwinCAT library available
Operating temperature	0...+55 °C	0...+55 °C	0...+55 °C
Approvals	CE, Ex	CE, UL, Ex	CE, UL, Ex
Weight	approx. 85 g	approx. 85 g	approx. 80 g
Further information	www.beckhoff.com/KL6401	www.beckhoff.com/KL6771	www.beckhoff.com/KL6811

Communication | TwinSAFE

TwinSAFE enables networks with up to 1,024 TwinSAFE devices. The KL6904 Bus Terminal features certified safety function blocks, which are configured according to the application to be realised. Functions such as emergency stop, safety door monitoring etc. can thus easily be selected and linked. All blocks can be freely connected among each other and are complemented by operators such as AND, OR, etc. The necessary functions are configured using the TwinCAT System Manager and loaded into the terminal via the fieldbus.

For further information on TwinSAFE and the TwinSAFE products see page **828**

TwinSAFE Logic Bus Terminal,
4 safe inputs

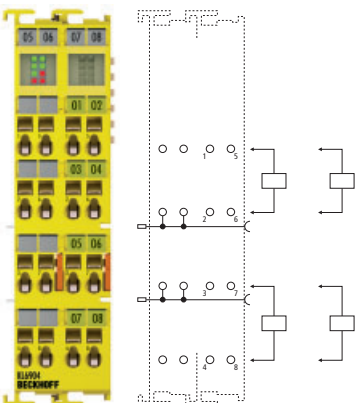
Technical data	KL6904
Technology	TwinSAFE Logic
Safety standard	IEC 61508 SIL 3 and DIN EN ISO 13849-1:2008 PL _e
Number of outputs	4
Protocol	TwinSAFE/FSOE
	 <p>The KL6904 TwinSAFE Logic Bus Terminal can establish 15 connections (TwinSAFE connections). The TwinSAFE logic terminal has four safe, local outputs, so that safety applications can be realised with only two components (KL1904 and KL6904).</p>
Nominal voltage	24 V DC (-15 %/+20 %)
Current consum. pow.cont.	load-dependent
Current consumpt. K-bus	250 mA
Cycle time	4...100 ms
Fault response time	≤ watchdog time (parameterisable)
Output current	0.5 A max./20 mA min. (per channel)
Permiss. degree of contamination	2
Climate class EN60721-3-3	3K3
Installation position	horizontal
Special features	4 safe outputs
Operating temperature	0...+55 °C
Electrical interference	EN 61000-6-2/EN 61000-6-4
Vibration/shock resistance	EN 60068-2-6/EN 60068-2-27/29
Approvals	CE, UL, Ex, TÜV Süd
Weight	approx. 90 g
Further information	www.beckhoff.com/KL6904
Special terminals	KL6904-0001
Distinguishing features	preconfigured ex factory to 15 TwinSAFE connections

Power terminals | Siemens contactor, series Sirius 3R

The KL8001 power terminal, together with a power contactor, forms a complete distributed motor starter with any fieldbus connection. Apart from all the protective functions of a motor protection relay, the power terminal contains comprehensive diagnostics. By means of values such as current, voltage, active-power input and apparent power consumption or load condition, the control programmer is able to regulate the drive or a machine component in the best possible way and to protect them from damage and failure. The Bus Terminal block is fitted with a KL9060 adapter terminal instead of a KL9010 end terminal. The KL9060 is connected to a power terminal using a simple ribbon cable. Up to ten power terminals can be driven by one KL9060. No other wiring is necessary apart from a ground cable.

The power terminal switches the installed contactor and takes over all the functions of the motor protection relay. Apart from its purely protective function of switching off the motor when overloaded, the power terminal can carry out numerous diagnostic functions on the motor and make the information available to the controller via the fieldbus.

KL9060 | End terminal with adapter connection for KL8001 power terminals
see page [598](#)

Power terminal for Siemens contactor, series Sirius 3R

Technical data	KL8001
Contactor	connection mechanism for Siemens contactor series Sirius 3R (switch size S00, Typ 3RT 10 1)
Measured values	current, voltage, power
Number of power terminals	up to 10 (at 140 mA typ. current consumption per contactor)
	 <p>Like a standard motor protection relay the KL8001 power terminal is fitted to a power contactor up to a switching capacity of 5.5 kW.</p>
Measuring accuracy	0.1 A AC
Current consumption power contacts	typ. 7 mA + load
Current consumpt. K-bus	typ. 150 mA
Measuring voltage	500 V AC
Power contacts	24 V DC (-15 %/+20 %)/1.4 A max., short-circuit-proof
Setting range of nominal current	0.9...9.9 A
Current load	max. 25 A (fuse)
Short-circuit-proof	up to 5 kA
Internal resistance	< 1 mΩ
Tripping classes	class 5, 10, 15, 20, 25, 30 selectable
Type of connection power path	screw terminals up to 2 x 2.5 mm ²
Type of K-bus connection	2 x flat plug socket, 10-pin
Adapter terminal	KL9060
Short circuit behaviour	conforms to EN 60947-4-1 (assignment type 2)/VDE 102
Triggering tolerance	conforms to IEC 947, as well as UL and CSA
Operating temperature	0...+55 °C
Approvals	CE
Weight	approx. 90 g
Further information	www.beckhoff.com/KL8001

Power terminals | TeSys U

The TeSys series from Schneider Electric/Télémécanique is a product family for the protection and switching of motors. Model U is a very compact motor starter that can be connected directly to the Bus Terminal system via the KL8601 communication module from Beckhoff. Users of TeSys modules therefore have the complete fieldbus range of the Bus Terminal system available. Similar to the KL8001 power terminal from Beckhoff, the motor starter integrates seamlessly into the terminal bus.

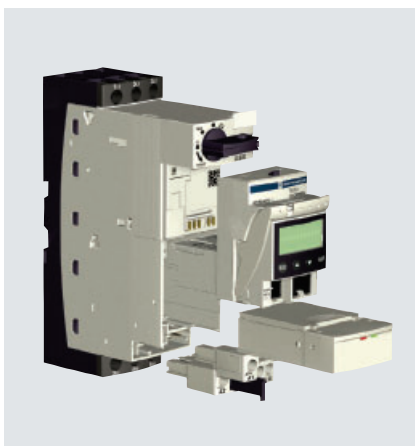

The motor starter is integrated into the fieldbus system via the KL8610 adapter terminal and a common, screened RJ 45 cable. The 24 V DC supply of the contactor systems is also transferred via this patch cable. The maximum distance between the KL8610 and the first motor starter module is 5 m; the maximum distance between two starters is 0.5 m. Up to eight starters can be connected in series. Spatial separation of I/O and power plane can thus be realised within the control cabinet.

Note: The KL8601 communication module, the KL8610 adapter terminal and the accessory cable can be ordered via Schneider Electric/Télémécanique and Beckhoff. The TeSys motor starters are only available from Schneider Electric, the Bus Terminal system only from Beckhoff.



Motor starter TeSys U

Further information can be found on the Internet at: www.schneider-electric.com

	Communication module for TeSys U	Adapter terminal for TeSys U
Technical data	KL8601	KL8610
Communication unit	TeSys U, all control devices (standard, expanded and multi-functional)	KL8601
Number of modules	up to 8 TeSys model U	up to 8 KL8601 TeSys model U
Number of outputs	2 (digital 24 V DC)	–
	 <p>The KL8601 communication module is plugged into the TeSys Model U motor starter. It connects the starter with the KL8610 adapter terminal and further motor starters with communication module. The KL8610 adapter terminal provides the connection with the Bus Terminal system. The control and status information of the motor starter evaluation unit are transferred to the Bus Terminal system via the KL8601 communication module.</p>	 <p>The KL8610 adapter terminal enables the connection of the TeSys Model U motor starter to the Beckhoff Bus Terminal system. Together with the KL8601 communication module, the KL8610 forms an operational unit in the TeSys motor starter. The KL8610 adapter terminal is attached to the end of the bus terminal block. No further parameterising or configuration work on the KL8610 is necessary apart from plugging-in the connecting cable.</p>
Voltage	–	24 V DC (-15 %/+20 %)
Current consumption system bus	20 mA + load current, max. 2 x 0.5 A	–
Current consumpt. K-bus	–	typ. 32 mA
Output current	0.5 A short-circuit-proof	–
Current load	–	max. 2 A short-circuit-proof
Operating temperature	0...+55 °C	0...+55 °C
Approvals	CE	CE
Weight	approx. 70 g	approx. 65 g
Further information	www.beckhoff.com/KL8601	www.beckhoff.com/KL8610

KL91xx, KL92xx | Function terminals

The power feed terminals make it possible to set up various potential groups with any desired voltages (KL9190) or with the standard voltages of 24 V DC or 230 V AC (120 V AC). The power feed terminals are available with or without fine-wire fuse. In order to monitor the supply voltage, the terminals with diagnostics report the status of the power feed terminal to the Bus Coupler through two input bits. It is thus possible for the controller to check the distributed peripheral voltage over the fieldbus. The operating point performance conforms to the input terminals KL1002 (24 V) and KL1702 (230 V).

The KL9180, KL9185 and KL9195 Bus Terminals allow the supply voltage to be accessed a number of times via spring force terminals. These Bus Terminals make it unnecessary to use additional terminal blocks on the terminal strip. The KL9195 Bus Terminal can be used for the connection of screens. The KL9195 connects the spring force contacts directly to the DIN rail, and can optimally ground incoming electromagnetic radiation. The two power contacts are looped through by the KL9195, allowing two wires to be connected to each power contact. The KL9010 bus end terminal is necessary for data exchange between the Bus Coupler and the Bus Terminals. Each assembly must be terminated at the right hand end with a KL9010 bus end terminal. The bus end terminal does not have any other function or connection facility. The KL9080 is used to identify potential groups (e.g. 230 V AC/ 24 V DC). It is inserted between two potential groups, and indicates the separation through an orange coloured cover.

	Potential supply terminal, 24 V DC	Potential supply terminal, 24 V DC, with diagnostics	Potential supply terminal, 120... 230 V AC	Potential supply terminal, 120...230 V AC, with diagnostics	Potential supply terminal, any voltage up to 230 V AC
Technical data	KL9100 KS9100	KL9110 KS9110	KL9150 KS9150	KL9160 KS9160	KL9190 KS9190
Technology	potential supply terminal				
Diagnostics in the process image	–	yes	–	yes	–
Nominal voltage	24 V DC	24 V DC	120 V AC/ 230 V AC	120 V AC/ 230 V AC	arbitrary
Current load	≤ 10 A	≤ 10 A	≤ 10 A	≤ 10 A	≤ 10 A
Integrated fine-wire fuse	–	–	–	–	–
Power LED	green	green	green	green	–
Defect LED	–	–	–	–	–
PE contact	yes	yes	yes	yes	yes
Shield connection	–	–	–	–	–
Current consumption K-bus	–	typ. 10 mA	–	typ. 10 mA	–
Electrical isolation	yes	yes	yes	yes	yes
Connection to DIN rail	–	–	–	–	–
Special features	–	–	–	–	–
Operating temperature	-20...+60 °C	-20...+60 °C	0...+55 °C	0...+55 °C	0...+55 °C
Approvals	CE, UL, Ex, GL	CE, UL, Ex, GL	CE, UL, GL	CE, UL, GL	CE, UL, Ex, GL
Weight	approx. 50 g	approx. 50 g	approx. 50 g	approx. 50 g	approx. 50 g
Further information	www.beckhoff.com/ KL9100	www.beckhoff.com/ KL9110	www.beckhoff.com/ KL9150	www.beckhoff.com/ KL9160	www.beckhoff.com/ KL9190

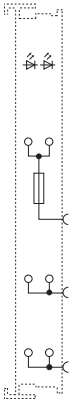
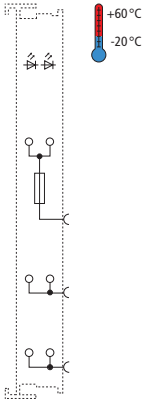
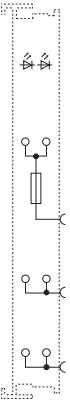
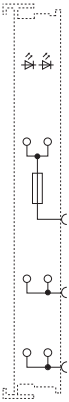
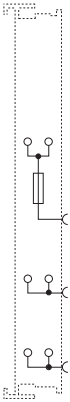
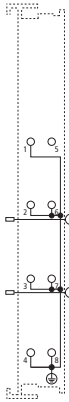
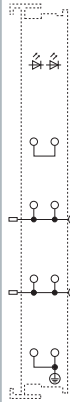
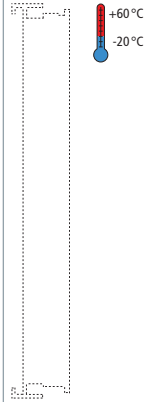
Potential supply terminal, 24 V DC, with fuse	Potential supply terminal, 24 V DC, with diagnostics and fuse	Potential supply terminal, 120...230 V AC, with fuse	Potential supply terminal, 120...230 V AC, with diagnostics and fuse	Potential supply terminal, arbitrary, with fuse	Shield terminal	Shield terminal	Separation terminal
KL9200	KL9210	KL9250	KL9260	KL9290	KL9070 KS9070	KL9195 KS9195	KL9080
					shield terminal	shield terminal	separation terminal
–	yes	–	yes	–			
							
24 V DC	24 V DC	120 V AC/ 230 V AC	120 V AC/ 230 V AC	arbitrary up to 230 V AC/DC	≤ 60 V	arbitrary up to 230 V AC	separation terminal
≤ 10 A	≤ 10 A	≤ 10 A	≤ 10 A	≤ 10 A	≤ 10 A	≤ 10 A	–
...6.3 A	...6.3 A	...6.3 A	...6.3 A	...6.3 A	–	–	–
green	green	green	green	–	–	–	–
red	red	red	red	–	–	–	–
yes	yes	yes	yes	yes	–	–	–
–	–	–	–	–	8 x	2 x	–
–	typ. 10 mA	–	typ. 10 mA	–	–	–	–
yes	yes	yes	yes	yes	yes	–	–
–	–	–	–	–	yes	yes	–
–	integrated fuse	integrated fuse	integrated fuse	integrated fuse	dissipation of EMC interference via large copper surfaces on the DIN rail	–	placeholder ter- minal with K-bus transmission
0...+55 °C	-20...+60 °C	0...+55 °C	0...+55 °C	0...+55 °C	0...+55 °C	0...+55 °C	-20...+60 °C
CE, UL, Ex, GL	CE, UL, Ex, GL	CE, UL, Ex, GL	CE, UL, Ex, GL	CE, UL, Ex, GL	CE, UL, Ex	CE, UL, Ex, GL	CE, UL, Ex, GL
approx. 50 g	approx. 55 g	approx. 55 g	approx. 55 g	approx. 50 g	approx. 50 g	approx. 50 g	approx. 50 g
www. beckhoff.com/ KL9200	www. beckhoff.com/ KL9210	www. beckhoff.com/ KL9250	www. beckhoff.com/ KL9260	www. beckhoff.com/ KL9290	www. beckhoff.com/ KL9070	www. beckhoff.com/ KL9195	www. beckhoff.com/ KL9080

KL91xx | Function terminals, potential distribution

The KL91xx potential distribution terminals enable – depending upon the type – the distribution of ground or supply potentials to external devices. Wiring work and separate potential distributors are saved. Eight ground points are required for the ground connection of 8-channel output terminals in 2-wire operating mode, e.g. KL2008, for which the KL9187 can be used. The KL9184 and KL9188 HD Bus Terminals (High Density) even make 16 connection points available in a compact housing.

Potential distribution terminal, 2 terminal points per power contact



Potential distribution terminal, 4 terminal points at 2 power contacts

Technical data	KL9180 KS9180	KL9185 KS9185
Technology	potential distribution terminal	
Diagnostics in the process image	–	
Nominal voltage	arbitrary up to 230 V AC	arbitrary up to 230 V AC
Current load	≤ 10 A	≤ 10 A
Integrated fine-wire fuse	–	–
Power LED	–	–
Defect LED	–	–
PE contact	yes	–
Shield connection	–	–
Current consumption K-bus	–	–
Electrical isolation	–	–
Connection to DIN rail	–	–
Special features	–	–
Operating temperature	0...+55 °C	0...+55 °C
Approvals	CE, UL, Ex, GL	CE, UL, Ex, GL
Weight	approx. 50 g	approx. 50 g
Further information	www.beckhoff.com/KL9180	www.beckhoff.com/KL9185

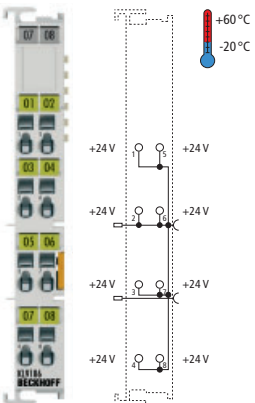
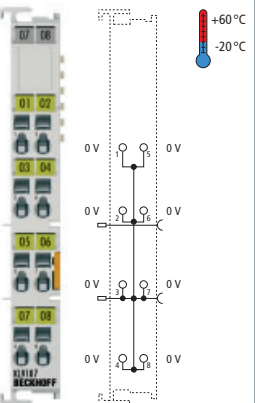
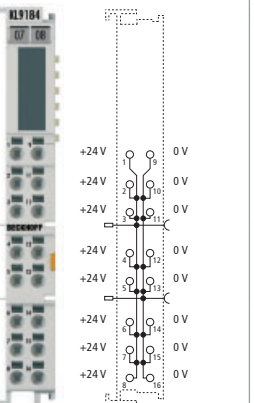
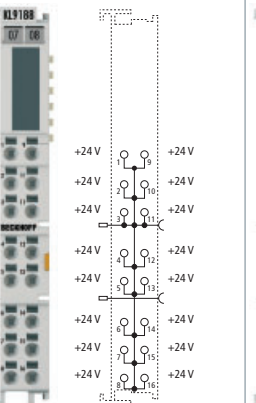
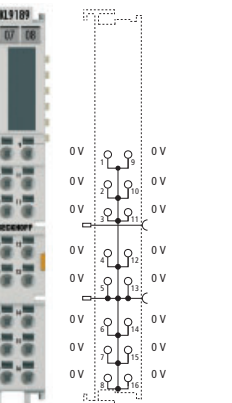
Potential distribution terminal, 8 x 24 V	Potential distribution terminal, 8 x 0 V	Potential distribution terminal, 8 x 24 V, 8 x 0 V	Potential distribution terminal, 16 x 24 V	Potential distribution terminal, 16 x 0 V
KL9186 KS9186	KL9187 KS9187	KL9184	KL9188	KL9189

				
≤ 60 V DC	≤ 60 V DC	≤ 60 V DC	≤ 60 V DC	≤ 60 V DC
≤ 10 A	≤ 10 A	≤ 10 A	≤ 10 A	≤ 10 A
–	–	–	–	–
–	–	–	–	–
–	–	–	–	–
–	–	–	–	–
–	–	–	–	–
yes	yes	yes	yes	yes
–	–	–	–	–
8 x 24 V connection	8 x 0 V connection	8 x 24 V and 8 x 0 V connection	16 x 24 V connection	16 x 0 V connection
-20...+60 °C	-20...+60 °C	0...+55 °C	0...+55 °C	0...+55 °C
CE, UL, Ex, GL	CE, UL, Ex, GL	CE, Ex	CE, Ex	CE, Ex
approx. 50 g	approx. 50 g	approx. 60 g	approx. 60 g	approx. 60 g
www.beckhoff.com/KL9186	www.beckhoff.com/KL9187	www.beckhoff.com/KL9184	www.beckhoff.com/KL9188	www.beckhoff.com/KL9189

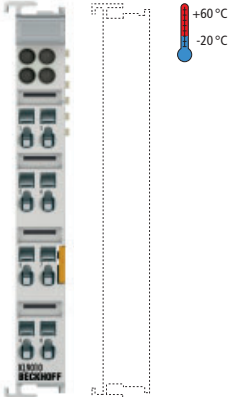
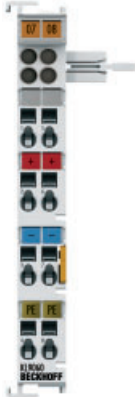
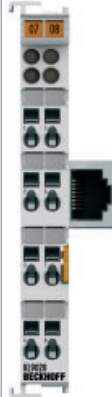
KL90xx | Function terminals

	End terminal	Adapter terminal for KL8001 power terminals	End terminal for bus extension	Coupler terminal for bus extension
Technical data	KL9010	KL9060	KL9020	KL9050
Technology	end terminal			coupler terminal
Diagnostics in the process image	–			yes
		 <p>The KL9060 Bus Terminal enables a connection to the KL8001. For further information see page 592</p>	 <p>The KL9020 forms a properly working unit together with at least one KL9050. No further parameterisation or configuration work is necessary.</p>	 <p>The KL9050 coupler terminal replaces the Bus Coupler on a Bus Terminal block. The second RJ 45 socket allows the system to be extended further. The whole system can be extended by 31 stations.</p>
Nominal voltage	–	24 V DC (-15 %/+20 %)	24 V DC (-15 %/+20 %)	24 V DC (-15 %/+20 %)
Current load	–	≤ 10 A	≤ 10 A	≤ 10 A
Power LED	–	–	–	green
Defect LED	–	–	–	–
PE contact	–	yes	–	yes
Current consumption K-bus	–	–	typ. 70 mA	typ. 70 mA + (total K-bus current)/4, max. 200 mA
Distance between stations	–	–	max. 5 m between KL9020 and KL9050	max. 5 m between KL9050 and KL9050
Starting current	–	–	–	2.5 x continuous current
Current supply K-bus	–	–	–	up to 400 mA
Electrical isolation	–	500 V (power contact/supply voltage/K-bus)	500 V (power contact/supply voltage/K-bus)	500 V (power contact/supply voltage/fieldbus)
Special features	end terminal for bus communication	connection to KL8001 via 20-pin flat ribbon plug	end terminal for K-bus extension	coupler terminal for K-bus extension (max. 64 Bus Terminals)
Operating temperature	-20...+60 °C	0...+55 °C	0...+55 °C	0...+55 °C
Approvals	CE, UL, Ex, GL	CE	CE, UL, Ex, GL	CE, Ex, GL
Weight	approx. 50 g	approx. 65 g	approx. 45 g	approx. 75 g
Further information	www.beckhoff.com/KL9010	www.beckhoff.com/KL9060	www.beckhoff.com/KL9020	www.beckhoff.com/KL9050

KL93xx | Diode array Bus Terminals

Diodes perform different tasks in control circuits. They decouple, rectify or provide for the free-running of a coil. The Bus Terminals unite diodes in different circuits and simplify integration into the control cabinet by their compact design. The circuits offered, with common anode or cathode and the individual diodes, minimise the wiring effort in the control cabinet.

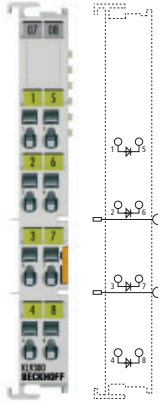
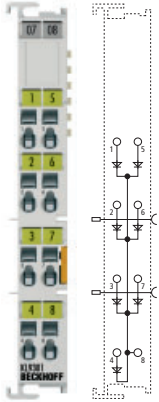
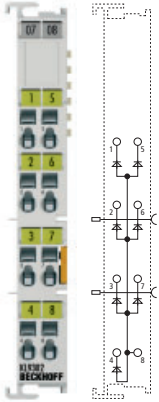
	Diode array terminal, 4 potential-free diodes	Diode array terminal, 7 diodes (with a common cathode)	Diode array terminal, 7 diodes (with a common anode)
Technical data	KL9300 KS9300	KL9301 KS9301	KL9302 KS9302
Technology	free-wheeling or decoupling diodes		
Number of diodes	4	7	
Interconnection	potential-free	common cathode	common anode
			
Nominal cut-off voltage	1,000 V (diodes)	1,000 V (diodes)	1,000 V (diodes)
Output current	1 A on each diode	1 A on each diode	1 A on each diode
Peak current	2.5 A (100 ms)	2.5 A (100 ms)	2.5 A (100 ms)
Voltage drop	0.7 V typ.	0.7 V typ.	0.7 V typ.
Current consumption K-bus	–	–	–
Isolation voltage	< 200 V (channel/channel)	< 200 V (channel/channel)	< 200 V (channel/channel)
Electrical isolation	1,500 V (K-bus/field)	1,500 V (K-bus/field)	1,500 V (K-bus/field)
Operating temperature	0...+55 °C	0...+55 °C	0...+55 °C
Approvals	CE, UL, Ex	CE, UL, Ex	CE, UL, Ex
Weight	approx. 50 g	approx. 55 g	approx. 55 g
Further information	www.beckhoff.com/ KL9300	www.beckhoff.com/ KL9301	www.beckhoff.com/ KL9302

KL94xx, KL95xx | Power supply terminals

The KL94xx and KL95xx terminal series are designed for the modified feeding of the operating voltage into the terminal strand. The KL9400 power supply terminal enables the refreshment of the K-bus, via which data exchange takes place between Bus Couplers and Bus Terminals. Each Bus Terminal requires a certain amount of current from the K-bus (see technical data: "Current consumption K-bus"). This current is fed into the K-bus by the relevant Bus Coupler's power supply unit. When configuring a large number of Bus Terminals, the 5 V power supply to the K-bus can be increased by 2 A via the KL9400.

The KL95xx power supply terminals produce different output voltages from the input voltage (24 V DC) that can be accessed at the terminals. The following Bus Terminals are also supplied with this voltage via the power contacts. The power LEDs indicate the operating states of the terminals; short-circuits or overloads are indicated by the overcurrent LEDs. There is no electrical isolation of the input and output voltage.

Power supply terminal
for refreshing the K-bus

Power supply terminal,
5 V DC

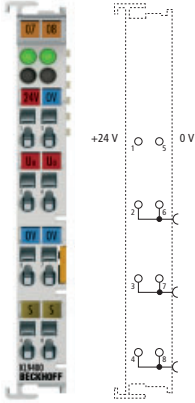
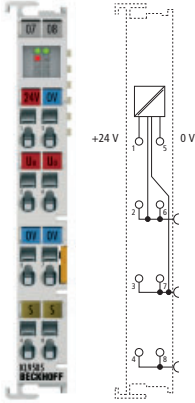
Technical data	KL9400 KS9400	KL9505 KS9505
Technology	power supply terminal	power supply terminal, 5 V DC, with diagnostics
Diagnostics	–	yes
		
Input voltage	24 V DC (-15 %/+20 %)	24 V DC (-15 %/+20 %)
Output voltage	5 V DC	5 V DC \pm 1 %
Output current	2 A for K-bus supply	0.5 A
Short-circuit-proof	yes	yes
Residual ripple	–	< 5 mV
Current consumption K-bus	–	–
Electrical isolation	–	–
Special features	–	stabilised analog voltage
Operating temperature	0...+55 °C	0...+55 °C
Approvals	CE, UL, Ex, GL	CE, UL, Ex
Weight	approx. 65 g	approx. 65 g
Further information	www.beckhoff.com/KL9400	www.beckhoff.com/KL9505

The KL9505 generates 5 V from the fed-in 24 V without electrical isolation.

Power supply terminal, 8 V DC	Power supply terminal, 10 V DC	Power supply terminal, 12 V DC	Power supply terminal, 15 V DC	Power supply terminal, 24 V DC, electrical isolation
KL9508 KS9508	KL9510 KS9510	KL9512 KS9512	KL9515 KS9515	KL9560 KS9560
power supply terminal, 8 V DC, with diagnostics	power supply terminal, 10 V DC, with diagnostics	power supply terminal, 12 V DC, with diagnostics	power supply terminal, 15 V DC, with diagnostics	power supply terminal, 24 V DC

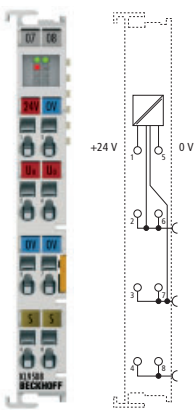

The KL9508 generates 8 V from the fed-in 24 V without electrical isolation.

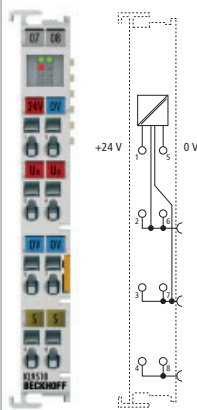

The KL9510 generates 10 V from the fed-in 24 V without electrical isolation.

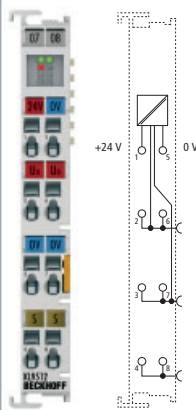

The KL9512 generates 12 V from the fed-in 24 V without electrical isolation.

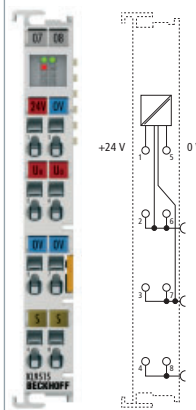

The KL9515 generates 15 V from the fed-in 24 V without electrical isolation.

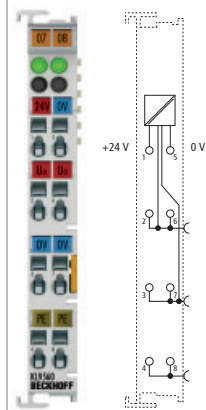

The KL9560 generates potential-free 24 V from the fed-in 24 V with electrical isolation.

24 V DC (-15 %/+20 %)	24 V DC (-15 %/+20 %)	24 V DC (-15 %/+20 %)	24 V DC (-15 %/+20 %)	24 V DC (-15 %/+20 %)
8 V DC ±1 %	10 V DC ±1 %	12 V DC ±1 %	15 V DC ±1 %	24 V DC (-15 %/+5 %)
0.5 A	0.5 A	0.5 A	0.5 A	≤ 0.1 A
yes	yes	yes	yes	yes, automatic restart
< 5 mV	< 5 mV	< 5 mV	< 5 mV	no data
–	–	–	–	–
–	–	–	–	1,500 V AC constant load input/output voltage
stabilised analog voltage	stabilised analog voltage	stabilised analog voltage	stabilised analog voltage	analog voltage with electrical isolation
0...+55 °C	0...+55 °C	0...+55 °C	0...+55 °C	0...+55 °C
CE, UL, Ex	CE, UL, Ex	CE, UL, Ex	CE, UL, Ex	CE, UL, Ex, GL
approx. 65 g	approx. 65 g	approx. 65 g	approx. 65 g	approx. 65 g
www.beckhoff.com/KL9508	www.beckhoff.com/KL9510	www.beckhoff.com/KL9512	www.beckhoff.com/KL9515	www.beckhoff.com/KL9560

KL9520, KL9528 | AS-Interface system terminals

An AS-Interface network consists of a special power supply unit, a master and a larger number of slaves. Each communication device is connected in parallel to the AS-Interface cable, and receives its supply voltage and also exchanges its data via this connection. The transmitter changes its current consumption according to its transmission bits. The AS-Interface power supply unit converts this current change into a voltage change, which can be measured by all devices. An AS-Interface power supply unit supplies the network with a voltage of 30 V in order to ensure that sufficient voltage is available to all devices with maximum cable length and maximum current consumption.

The KL9528 Bus Terminal is an AS-Interface power supply unit with an output current of up to 1.25 A. The AS-Interface supply voltage of 30 V is generated from the 24 V control voltage. The KL9520 Bus Terminal is intended for AS-Interface Power24V applications. Thanks to an internal circuit, the 24 V control voltage is usable for a simple AS-Interface network. An AS-Interface voltage of 24 V is sufficient in many small networks if the cable lengths and current consumption do not cause a large voltage drop.

AS-Interface potential feed terminal with filter	AS-Interface power supply terminal 24 V DC/30 V DC, 1.25 A
--	--

Technical data	KL9520 KS9520	KL9528 KS9528
Technology	potential feed terminal	power supply terminal
Diagnostics	–	–

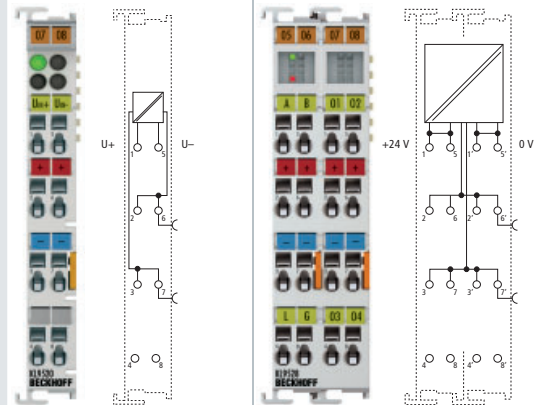

The KL9520 potential feed terminal uncouples the input and output signal through an integrated filter and enables the supply of AS-Interface networks from standard power supply units or another AS-Interface network.

The KL9528 power supply terminal generates a 30 V DC output voltage from the 24 V DC control voltage with high-frequency decoupling for the operation of an AS-Interface network. The connection to the KL6201 AS-Interface master is established via plugs.

Input voltage	up to 35 V	21...28.8 V DC
Output voltage	up to 35 V	30 V DC (+5 %/- 5 %)
Output current	–	max. 1.25 A
Short circuit current	–	max. 1.3 A
Current load	max. 2 A	–
Current consumption K-bus	–	typ. 10 mA
Electrical isolation	–	1,500 V AC constant load field side/K-bus
Special features	no electrical isolation	–
Operating temperature	0...+55 °C	0...+55 °C
Approvals	CE	CE
Weight	approx. 90 g	approx. 150 g
Further information	www.beckhoff.com/KL9520	www.beckhoff.com/KL9528

KL9540, KL9550 | Surge filter system and field supply

The KL9540 system terminal contains an overvoltage filter for the 24 V field supply, the KL9550 for the 24 V field and system supply. The filter protects the Bus Terminals from line-bound surge voltages that can occur due to high-energy disturbances such as switching overvoltages at inductive consumers or lightning strikes at the supply lines. The Bus Terminals KL9540 or KL9550 protect the Bus Terminal station from damage in particularly harsh environments. The ship classification organisations require the use in shipbuilding applications and in the onshore/offshore sector.

System terminal,
surge filter field supply

System terminal,
surge filter system
and field supply

Technical data	KL9540 KS9540	KL9550 KS9550
Technology	surge filter field supply	surge filter system and field supply
Diagnostics	-	
Nominal voltage	24 V (-15 %/+20 %)	24 V (-15 %/+20 %)
Surge filter field supply	yes	yes
Surge filter system supply	-	yes
PE connection	yes	-
Operating temperature	-20...+60 °C	-20...+60 °C
Approvals	CE, UL, Ex, GL	CE, UL, Ex, GL
Weight	approx. 40 g	approx. 50 g
Further information	www.beckhoff.com/KL9540	www.beckhoff.com/KL9550

KL9570 | Buffer capacitor terminal

The KL9570 Bus Terminal contains high-performance capacitors for stabilising supply voltages. It can be used in connection with small drive terminals. Low internal resistance and high pulsed current capability enable good buffering in parallel with a power supply unit. Return currents are stored, particularly in the context of drive applications, thereby preventing overvoltages. If the fed back energy exceeds the capacity of the capacitors, the KL9570 switches the load voltage through to the terminal points 1 and 5. The energy is dissipated by the connection of an external ballast resistor.

KL25xx | Motion terminals see page [550](#)

Buffer capacitor terminal

Technical data	KL9570 KS9570
Technology	buffer capacitor terminal
Diagnostics	–

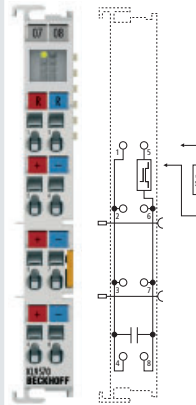

The KL9570 buffers the connected voltage via its integrated capacitors and connects the external brake resistor if the internal voltage of approx. 56 V is exceeded.

Nominal voltage	50 V
Capacity	500 μ F
Ripple current	10 A in continuous operation
Internal resistance	< 10 m Ω
Surge voltage protection	> 56 V
Recommended ballast resistor	10 Ω , typ. 10 W
Overvoltage control range	\pm 2 V
Ballast resistor clock rate	load-dependent, 2-point control
Electrical isolation	1,500 V (terminal/K-bus)
Operating temperature	0...+55 $^{\circ}$ C
Approvals	CE, Ex
Weight	approx. 65 g
Further information	www.beckhoff.com/KL9570

Ordering instructions for special terminals and couplers

All Bus Couplers and Bus Terminals are supplied with a standard configuration. The settings can be found on the relevant catalog pages. In addition to this standard configuration, specific coupler and terminal types with modified software or hardware are available. These variants have an order number with additional four figures. Therefore, if you do require a configuration other than standard, quote this extended number when you place your order. The following table provides a summary of the Bus Couplers and Bus Terminals that are available with modified default settings.

Ordering information	
Bus Coupler	
BK8100-0060	watchdog special setting 60 s
BK8100-1001	watchdog special setting 10 s
Digital input	
KL1052-0010	96 V DC positive and negative switching, not in accordance with the EN 61131-2 specifications: I high = 3 mA, I low = 0.5 mA
KL1232-0001	plus-switching, positive edge-triggered input, 10 ms pulse extension, input filter 0.2 ms
KL1232-0002	plus-switching, positive edge-triggered input, 20 ms pulse extension, input filter 0.2 ms
KL1232-0010	plus-switching, positive edge-triggered input, 100 ms pulse extension, input filter 3.0 ms
KL1232-0100	plus-switching, negative edge-triggered input, 100 ms pulse extension, input filter 0.2 ms
KL1232-0110	plus-switching, negative edge-triggered input, 100 ms pulse extension, input filter 3.0 ms
KL1232-1000	negative switching, positive edge-triggered input, 100 ms pulse extension, input filter 0.2 ms
KL1232-1001	5 V, negative switching, negative edge-triggered input, 20 ms pulse extension, input filter 0.2 ms
KL1232-1010	negative switching, positive edge-triggered input, 100 ms pulse extension, input filter 3.0 ms
KL1232-1100	negative switching, negative edge-triggered input, 100 ms pulse extension, input filter 0.2 ms
KL1232-1110	negative switching, negative edge-triggered input, 100 ms pulse extension, input filter 3.0 ms
KL1232-2000	plus switching, positive edge-triggered input, 200 ms pulse extension, input filter 0.2 ms
KL1501-0010	gate-counter with auto-reset and setting A0
KL1501-0011	up/down counter with 5 V inputs, 24 V DC outputs
KL1702-0010	230 V AC input circuit with type 2 characteristics
KL1712-0010	24 V AC/DC input circuit
Digital output	
KL2502-0012	time-delayed setting of the outputs
KL2502-3020	5 V output, 30 kHz limit frequency
KL2521-0010	with additional outputs (230 V AC/DC, 100 mA) instead of the additional inputs of the default variant
KL2521-0024	for 24 V signal level
KL2541-0006	stepper motor terminal 50 V DC, 5 A, 5 V encoder supply
KL2692-1001	2 digital inputs, 2 potential-free relays, end terminal variant
KL2702-0020	2-channel solid state load relay up to 230 V AC/DC, 1.5 A
KL2722-0010	without reciprocal locking of the channels, total current 1 A
KL2732-0010	without reciprocal locking of the channels, total current 1 A
KL2751-0011	dimmer terminal without power contacts
KL2751-1200	dimmer terminal for 120 V AC
KL2761-0011	1-channel universal dimmer terminal, 230 V AC, 600 VA (W), 50 Hz, without power contacts
KL2791-0011	1-channel AC motor speed controller, 230 V AC, 200 VA, max. 0.9 A, without power contacts
KL2791-1200	1-channel AC motor speed controller, 120 V AC, 100 VA
Analog input	
KL3002-0010	Siemens S5 format
KL3002-0011	fast μ P, scan time approx. 0.5 ms
KL3002-0050	Siemens S7 format
KL3012-0011	altered range: 0...21.5 mA, maximum value corresponds to 21.5 mA instead of 20 mA
KL3012-0012	fast μ P, scan time approx. 0.5 ms
KL3012-0050	Siemens S7 format
KL3022-0010	Siemens S5 format
KL3022-0011	fast μ P, scan time approx. 0.5 ms
KL3022-0050	Siemens S7 format

KL3042-0010	Siemens S5 format
KL3042-0011	fast μ P, scan time approx. 0.5 ms
KL3042-0012	altered range: 0...21.5 mA, maximum value corresponds to 21.5 mA instead of 20 mA
KL3042-0050	Siemens S7 format
KL3052-0010	Siemens S5 format
KL3052-0011	fast μ P, scan time approx. 0.5 ms
KL3052-0012	changed diagnostic level (<3.5 mA or >21.5 mA)
KL3052-0050	Siemens S7 format
KL3054-0050	Siemens S7 format
KL3062-0010	Siemens S5 format
KL3062-0011	voltage level 0...20 V
KL3062-0012	fast μ P, scan time approx. 0.5 ms
KL3062-0013	voltage level 0...30 V
KL3062-0014	voltage level 0...50 V
KL3062-0050	Siemens S7 format
KL3064-0010	Siemens S5 format
KL3064-0011	voltage level 0...20 V
KL3064-0050	Siemens S7 format
KL3102-0050	Siemens S7 format
KL3112-0050	Siemens S7 format
KL3122-0050	Siemens S7 format
KL3172-0500	2-channel analog input terminal, 0...500 mV
KL3202-0010	PT200
KL3202-0011	PT200 in Siemens S5 format
KL3202-0012	PT500
KL3202-0013	PT500 in Siemens S5 format
KL3202-0014	PT1000
KL3202-0015	PT1000 in Siemens S5 format
KL3202-0016	Ni100
KL3202-0017	Ni100 in Siemens S5 format
KL3202-0020	resistance measurement 0...1.2 k Ω
KL3202-0021	PT100 in Siemens S5 format
KL3202-0023	Ni120
KL3202-0024	Ni120 in Siemens S5 format
KL3202-0025	Ni1000
KL3202-0026	Ni1000 in Siemens S5 format
KL3202-0027	resistance measurement 10...10 k Ω
KL3202-0028	Resolution increased to 0.01 °C; the measurement range is reduced to -40 °C to +128 °C. The absolute accuracy is 0.3 °C, differential error is 0.1 °C.
KL3202-0029	Ni1000 per Landis&Staeafa characteristic curve (Siemens, 100° corresponds to 1,500 Ω)
KL3204-0014	PT1000
KL3204-0021	PT1000 in Siemens S5 format
KL3204-0025	Ni1000, 4-channel
KL3204-0029	Ni1000 per Landis&Staeafa characteristic curve (Siemens, 100° corresponds to 1,500 Ω)
KL3312-0010	type J
KL3312-0011	type J in Siemens S5 format
KL3312-0012	type L
KL3312-0013	type L in Siemens S5 format
KL3312-0014	type B
KL3312-0015	type B in Siemens S5 format
KL3312-0016	type E
KL3312-0017	type E in Siemens S5 format
KL3312-0018	type N
KL3312-0019	type N in Siemens S5 format
KL3312-0020	type R
KL3312-0021	type R in Siemens S5 format

KL3312-0022	type S
KL3312-0023	type S in Siemens S5 format
KL3312-0024	type T
KL3312-0025	type T in Siemens S5 format
KL3312-0026	type U
KL3312-0027	type U in Siemens S5 format
KL3312-0028	0...120 mV measurement
KL3312-0029	type K in Siemens S5 format
KL3312-0040	expanded temperature range for type S and L type S: -50...+1,700 °C (as supplied type L: -100...+900 °C)
KL3312-0110	type J, Fahrenheit scaling
KL3312-2000	setting of reference junction temperature via process image, unit 1/256° C in a 16 bit word
KL3312-2100	external reference point temperature specification via process image is possible, the unit is 1/256 °C in 16-bit format, fast conversion time 65 ms
KL3351-0001	1-channel resistor bridge terminal (strain gauge), with faster measurement time approx. 10 ms
KL3403-0010	3-phase power measurement terminal, current path designed for 5 A transducer (1 % measuring accuracy I)
KL3403-0020	3-phase power measurement terminal, current path designed for 20 mA, optimised for electronic current transformer
KL3403-0022	3-phase power measurement terminal, current path and voltage input designed for 20 mA
KL3403-0333	3-phase power measurement terminal, 500 V AC, 333 mV AC
KM3701-0340	differential pressure up to 340 hPa
Analog output	
KL4002-0010	Siemens S5 format
KL4002-0011	fast µP, scan time approx. 0.15 ms
KL4002-0050	Siemens S7 format
KL4004-0050	Siemens S7 format
KL4012-0010	Siemens S5 format
KL4012-0011	altered range: 0...21.5 mA, maximum value corresponds to 21.5 mA instead of 20 mA
KL4012-0050	Siemens S7 format
KL4022-0010	Siemens S5 format
KL4022-0050	Siemens S7 format
KL4032-0010	Siemens S5 format
KL4032-0011	fast µP, scan time approx. 0.15 ms
KL4032-0050	Siemens S7 format
KL4034-0010	Siemens S5 format
KL4112-0010	Siemens S5 format
KL4112-0050	Siemens S7 format
KL4132-0010	Siemens S5 format
KL4132-0050	Siemens S7 format
Special functions	
KL5111-0010	A, B, C signals: 5 V inputs
KL5111-0011	special function: latch input sets counter to zero
KL5111-0012	latches on both edges, A, B, C inputs 24 V
KL5111-0013	latches on both edges, A, B, C inputs 5 V
KL5111-0015	frequency measurement over a selectable time window; 24 V inputs
KL5111-0016	frequency measurement over a selectable time window; 5 V inputs
KL5111-0020	12 V input circuit
KL5151-0021	incremental encoder 1 x 32 bits A, B, capture input and 1 driver output 24 V, 0.5 A
KL5151-0050	incremental encoder 2 x 32 bits A, B-track
KL6001-0020	standard format 5 bytes of user data
KL6011-0020	standard format 5 bytes of user data
KL6021-0020	standard format 5 bytes of user data (rest default)
KL6021-0021	standard format 5 bytes of user data (7 bits, even, 1 stop bit, 9,600 baud)
KL6201-0010	preset to 22 bytes K-bus interface (2 K-bus cycles 31 AS-Interface slaves)
KL6201-0011	preset to 38 bytes K-bus interface (4 K-bus cycles 62 AS-Interface slaves)
KL6904-0001	TwinSAFE Logic Bus Terminal, preconfigured ex factory to 15 TwinSAFE connections
System terminals	
KL9210-0020	with 2 A fuse (slow-blow) and modified label

Accessories Bus Terminals

Connectors

Lightbus	Description
Z1000	standard connector for 1,000 µm plastic fibre
Z1010	standard connector for 200 µm PCS fibre
Z1020	coupling for Z1000

PROFIBUS	Description
ZB3100	9-pin D-sub connector for PROFIBUS (12 Mbaud) with switchable termination resistor
ZB3101	9-pin D-sub connector for PROFIBUS (12 Mbaud) with programming interface
ZB3102	9-pin D-sub connector for PROFIBUS (12 Mbaud) with programming interface (housing inverts)
ZS1031-3000	9-pin D-sub connector for PROFIBUS (12 Mbaud) with integrated termination resistor
ZS1031-3500	fibre optic connector for Bus Coupler BK3500 and BK3520

Interbus	Description
Z1003	FSMA plug with knurled nut for 1,000 µm plastic fibre
ZB4100	9-pin D-sub socket for incoming remote bus
ZB4101	9-pin D-sub plug for outgoing remote bus

CANopen/DeviceNet	Description
ZS1051-3000	9-pin D-sub connector for CANopen with integrated termination resistor
ZS1052-3000	5-pin open style connector for CANopen/DeviceNet with integrated termination resistor
ZS1052-5150	CAN diagnostic interface

SERCOS interface	Description
Z1003	FSMA plug with knurled nut for 1,000 µm plastic fibre
Z1100	plastic fibre optic, single core, 1,000 µm, 2.2 mm
Z1101	plastic fibre optic, single core, 1,000 µm with protective PU cladding and Kevlar strain relief, drag chain suitable

Ethernet/EtherCAT	Description	Pict.
ZS1090-0003	EtherCAT/Ethernet RJ 45 connector, IP 20, 4-pin, for field assembly, AWG 22-24, packing unit = 10	A
ZS1090-0005	EtherCAT/Ethernet RJ 45 plug, IP 20, 8-pin, field assembly, AWG 22-24, packing unit = 10	B

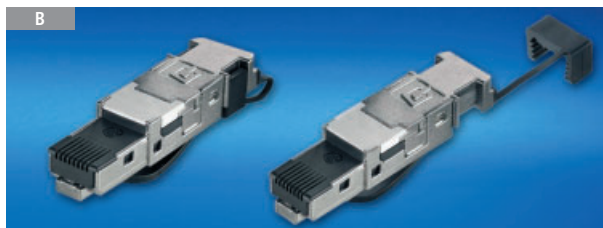
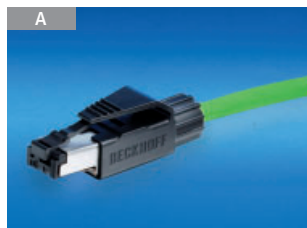

Bus interface connectors for PROFIBUS, CANopen/DeviceNet

The Beckhoff bus interface connector for PROFIBUS and CAN Bus Couplers simplifies bus wiring considerably. There are separate terminals for incoming and outgoing leads. A large area of the screen is connected via the cable grip. The integrated termination resistor can be switched externally. When it is switched on, it makes a break in the outgoing bus lead – this allows rapid fault location and guarantees that no more than two resistors are active in the network.

Technical data	ZS1031-3000	ZS1052-3000
Fieldbus	PROFIBUS	CANopen/DeviceNet
Bus plug	D-sub, 9-pin	open style connector, 5-pin
Data transfer rates	up to 12 Mbaud	up to 1 Mbaud (CANopen) or 500 kbaud (DeviceNet)
Cable outgoing	downwards (where Bus Terminals are assembled horizontally)	
Cable diameter	4.5...8 mm	
Wire cross section	0.34 mm wire	0.2...0.5 mm litz wire or wire
Connection method	screw type terminal	
Wire	PROFIBUS, type A, ZB3200	e.g. CANopen cable ZB5100 or DeviceNet cable ZB5200
Termination resistor	network with 2 x 390 Ω, 1 x 220 Ω	120 Ω
Protection class	IP 40	
Temperature range	-20...+75 °C	
Dimensions (L x W x H)	approx. (65 x 50 x 16) mm	
Packaging	folding box with instructions	

Cables for K-bus extension

Ordering information	Description
ZK1010-8080-3003	ribbon cable (3 cm) for connecting two KL8001 (included in the scope of supply)
ZK1010-8080-3005	ribbon cable (5 cm) for connecting two KL8001, if a reversing contactor connection is used
ZK1010-8080-3010	ribbon cable (10 cm) for connecting the KL9060 with the KL8001 (included in the scope of supply for KL9060)
ZS1010-1610	end plug for KL8001 (included in the scope of supply for KL9060)
ZK1090-0101-1002	extension cable with two plugs, double screened, red, 20 cm, cable for TeSys module KL8601/KL8610
ZK1090-0101-1005	extension cable with two plugs attached, double screened, red, 50 cm, cable for TeSys module KL8601/KL8610
ZK1090-0101-1010	extension cable with two plugs attached, double screened, red, 100 cm
ZK1090-0101-1020	extension cable with two plugs attached, double screened, red, 200 cm
ZK1090-0101-1030	extension cable with two plugs attached, double screened, red, 300 cm
ZK1090-0101-1050	extension cable with two plugs attached, double screened, red, 500 cm

USB cable for KS2000

The KS2000 cable establishes a connection between the Bus Couplers or Bus Terminal Controllers and the PC. The KS2000 can be used for parametering Bus Terminals or Bus Couplers, local diagnostics, forcing Bus Terminal data, monitoring Bus Terminal values, updating firmware and programming Beckhoff mini PLCs via TwinCAT. The USB cable features electrical isolation. Status LEDs indicate whether data are sent or received. On the connected PC the USB cable behaves like a COM port and can therefore be used for all Beckhoff tools using serial communication.

Ordering information	Description
KS2000-Z2-USB	connection cable for KS2000 or TwinCAT for serial conversion from USB for Bus Couplers or Bus Terminal Controllers of the BK, BC or LC series, length 3 m



Cables

Lightbus	Description
Z1100	plastic fibre optic, single core, 1,000 µm, 2.2 mm
Z1101	plastic fibre optic, single core, 1,000 µm with protective PU cladding and Kevlar strain relief, drag chain suitable
Z1111	HCS fibre optic, single core, 200 µm with protective PU cladding and Kevlar strain relief

PROFIBUS	Description
ZB3200	PROFIBUS cable 12 Mbaud 1 x 2 x 0.64 mm ²
Z1100	plastic fibre optic, single core, 1,000 µm, 2.2 mm
Z1101	plastic fibre optic, single core, 1,000 µm with protective PU cladding and Kevlar strain relief, drag chain suitable

Interbus	Description
ZB4200	Interbus remote bus cable, certified 3 x 2 x 0.22 mm ²
Z1120	Interbus plastic fibre optic, 2-core, 1,000 µm
Z1121	Interbus plastic fibre optic, 2-core, 1,000 µm with protective PU cladding

CANopen	Description
ZB5100	CAN cable, 4-core, fixed laying 2 x 2 x 0.25 mm ²

DeviceNet	Description
ZB5200	DeviceNet cable, 4-core with screen, fixed laying 2 x 2/22 AWG

Ethernet/EtherCAT	Description
ZB9010	Industrial Ethernet/EtherCAT cable, fixed installation, CAT 5e, 4 wires
ZB9020	Industrial Ethernet/EtherCAT cable, drag chain suitable, CAT 5e, 4 wires

Patch cables

Ethernet/EtherCAT	Description
ZK1090-9191-0001	Industrial Ethernet/EtherCAT patch cable, 0.17 m
ZK1090-9191-0002	Industrial Ethernet/EtherCAT patch cable, 0.26 m
ZK1090-9191-0005	Industrial Ethernet/EtherCAT patch cable, 0.5 m
ZK1090-9191-0010	Industrial Ethernet/EtherCAT patch cable, 1.0 m
ZK1090-9191-0020	Industrial Ethernet/EtherCAT patch cable, 2.0 m
ZK1090-9191-0030	Industrial Ethernet/EtherCAT patch cable, 3.0 m
ZK1090-9191-0050	Industrial Ethernet/EtherCAT patch cable, 5.0 m
ZK1090-9191-0100	Industrial Ethernet/EtherCAT patch cable, 10.0 m
ZK1090-9191-0150	Industrial Ethernet/EtherCAT patch cable, 15.0 m
ZK1090-9191-0200	Industrial Ethernet/EtherCAT patch cable, 20.0 m
ZK1090-9191-0250	Industrial Ethernet/EtherCAT patch cable, 25.0 m
ZK1090-9191-0300	Industrial Ethernet/EtherCAT patch cable, 30.0 m
ZK1090-9191-0350	Industrial Ethernet/EtherCAT patch cable, 35.0 m
ZK1090-9191-0400	Industrial Ethernet/EtherCAT patch cable, 40.0 m
ZK1090-9191-0450	Industrial Ethernet/EtherCAT patch cable, 45.0 m
ZK1090-9191-0500	Industrial Ethernet/EtherCAT patch cable, 50.0 m

For further information see page **414**

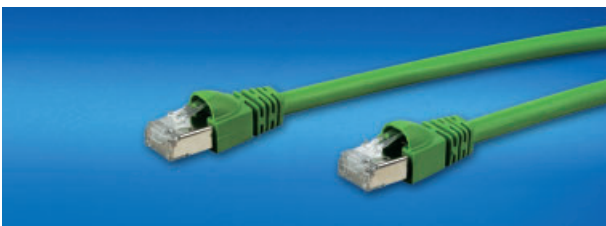

Connectors for KS Bus Terminals, ES EtherCAT Terminals

Ordering information	Description
ZS2010	10 connectors for KS and ES series, spare part (KS/ES terminals are supplied with connector.)

Connectors for KM and EM modules

Ordering information	Description
ZS2001-0001	connector for KM/EM module, 1-pin, without LED; spare part (KM/EM terminals are supplied with connector.)
ZS2001-0002	connector for KM/EM module, 1-pin, with LED; spare part (KM/EM terminals are supplied with connector.)
ZS2001-0004	connector for KM/EM module, 3-pin, with LED; spare part (KM/EM terminals are supplied with connector.)

Relays

Ordering information	Description
ZB2601	relay, 230 V AC, 16 A, coil 24 V, spare part KM2604
ZB2602	relay, manual operation, 230 V AC, 16 A, coil 24 V, spare part KM2614

Assembly aids

Ordering information	Description
ZB8700	slot screwdriver assembly tool for pressing the spring force clamps on the coupler and the terminals

Bus system housing

The BG1558 and BG1559 housings are especially suitable for the construction of compact I/O stations with a higher protection class (IP 65). The housings are supplied with mounting rails.

Ordering information	Description	Pict.
BG1558	bus system housing 400 mm x 200 mm x 120 mm (W x H x D) with mounting rails and holes	
BG1559	bus system housing 600 mm x 200 mm x 120 mm (W x H x D) with mounting rails and holes	

If desired, the housings can be supplied fully fitted with Bus Couplers, Bus Terminals, flanges and PG threaded fittings. Further sizes are available on request.



Marking material

The KLxxxx Bus Terminals can be individually labelled with standard contact signs. Signs with markings for the supply voltages are supplied together with the BKxxxx Bus Couplers, but can be changed if required. The marking material is not included in the Bus Terminal delivery.

Ordering information	Unprinted
BZ1000	100 unprinted contact labels
BZ1002	100 unprinted contact labels, yellow
BZ1005	100 unprinted contact labels, red
BZ1006	100 unprinted contact labels, blue
BZ1007	100 unprinted contact labels, orange
BZ1008	100 unprinted contact labels, light green
BZ3000	180 equipment identification labels 12 x 7 mm for Bus Terminals with removable identification section, blank

Ordering information	Printed
BZ1100	100 contact labels, printed with: 0 V, blue
BZ1102	100 contact labels, printed with: -, blue
BZ1104	100 contact labels, printed with: 24 V, red
BZ1106	100 contact labels, printed with: +, red
BZ1107	100 contact labels, printed with: +, white
BZ1108	100 contact labels, printed with: PE, light green
BZ1300	100 contact labels, ten of each printed with: 0...7, 20 unprinted, white
BZ1400	100 contact labels, two of each printed with: 00 01...48 49, white
BZ3010	180 equipment identification labels 12 x 7 mm for Bus Terminals with removable identification section, printed (printed according to customer specification [in Excel file])

Ordering information	Description
BZ5100	push-in strips for removable labels, 10 pages DIN A4, pre-punched



Coding pins and sockets for KS and ES terminals

The coding pins and sockets for ZS2010 and KS/ES terminals with pluggable wiring level enable coding between terminal and plug in order to prevent incorrect plug insertion.

Ordering information	Description
ZS2010-0010	The set contains 100 sockets and 100 pins.



Demokits

The Demokits offer a convenient and fast introduction to fieldbus communication with TwinCAT. Currently more than 10 fieldbuses are covered, including Lightbus, RS232, PROFIBUS, Ethernet, and EtherCAT. The aim of the Demokits is to familiarise the user with the basic TwinCAT automation procedures. Program creation and interfacing of the program with the hardware is explained in detail, based on examples. For many fieldbuses the Demokits are available both with Bus Couplers (BKxxxx) and Bus Terminal Controllers

(BCxxxx). A Bus Coupler serves as a physical interface between the selected fieldbus and the I/O terminals. It is therefore not programmable. In these Demokits the connected terminals receive their data from a higher-level PC. In contrast, the Bus Terminal Controllers are programmed from a PC via the selected fieldbus or a programming cable based on IEC 61131. After programming, the Bus Terminal Controllers autonomously manage the connected I/O terminals without involvement from the PC.

Each Demokit consists of:

- BKxxxx Bus Coupler or BCxxxx Bus Terminal Controller
- 2 digital input terminals 24 V DC
- 2 digital output terminals 24 V DC
- Beckhoff product folder
- Beckhoff TwinCAT CD
- “TwinCAT Quickstart” documentation
- documentation describing the Bus Coupler or Bus Terminal Controller used
- a 25 cm section of 35 mm mounting rail for fitting the terminal system

If required for the respective Demokit, the following additional components are included:

- programming cable (if a BCxxxx Bus Terminal Controller is used)
- TwinCAT PLC licence
- end terminal
- fieldbus cable (e.g. PROFIBUS or SERCOS cable)
- fieldbus interface card for the PC (e.g. PROFIBUS PCI master card or SERCOS PCI master card)

Ordering information	Demokits with Bus Coupler and TwinCAT PLC licence
TC9910-B110	EtherCAT, EK1100, EtherCAT Terminals
TC9910-B111	EtherCAT, EK1100, EtherCAT Terminals (without PLC licence)
TC9910-B112	EtherCAT, EK1100, EtherCAT Terminals (without PLC licence) (1 instead of 2 digital input terminals)
TC9910-B200	Lightbus, BK2020
TC9910-B310	PROFIBUS, BK3150
TC9910-B400	Interbus, BK4020
TC9910-B510	CANopen, BK5120
TC9910-B520	DeviceNet, BK5220
TC9910-B750	SERCOS, BK7520
TC9910-B800	RS485, BK8000
TC9910-B810	RS232, BK8100
TC9910-B900	Ethernet TCP/IP, BK9100
TC9910-B903	PROFINET, BK9103
TC9910-B905	EtherNet/IP, BK9105

Ordering information	Demokits with Bus Terminal Controller and TwinCAT PLC licence
TC9910-C200	Lightbus, BC2000
TC9910-C310	PROFIBUS, BC3150
TC9910-C400	Interbus, BC4000
TC9910-C730	Modbus, BC7300
TC9910-C800	RS485, BC8000
TC9910-C810	RS232, BC8100
TC9910-C815	RS232, BC8150
TC9910-C900	Ethernet TCP/IP, BC9100



Accessories radio technology

Possible connections	KM6551	587	CU8890	131
ZS6200-0400	x		x	
ZS6100-0900	x		x	
ZS6201-0410	x		x	
ZS6201-0500	x		x	
ZS6100-1800	x		-	

Omni-directional antenna 4 dBi

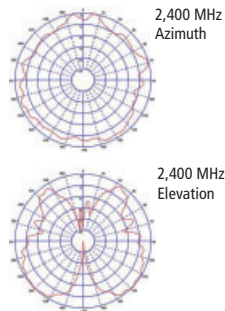

Technical data	ZS6200-0400
Frequency range	2,400...2,485 MHz
Gain	4 dBi
3 dB beamwidth, horizontal	360°
3 dB beamwidth, vertical	70°
Termination	SMA socket
Dimensions	height: 45 mm, diameter: 110 mm
Operating temperature	-40...+80 °C
Mounting	ceiling clip
Matching cables	ZK6000-0102-0020/-0040 (not included in the scope of supply)

Directional antenna 9 dBi

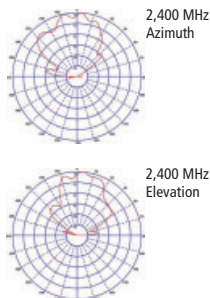

Technical data	ZS6100-0900
Frequency range	2,400...2,485 MHz
Gain	9 dBi
3 dB beamwidth, horizontal	65°
3 dB beamwidth, vertical	65°
Termination	SMA socket
Dimensions	93 mm x 93 mm x 25 mm (H x W x D)
Operating temperature	-40...+80 °C
Mounting	bracket mounting
Matching cables	ZK6000-0102-0020/-0040 (not included in the scope of supply)

Rod antenna 4 dBi

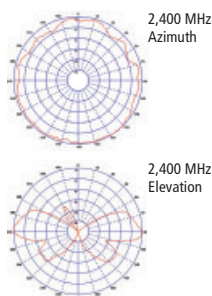

Technical data	ZS6201-0410
Frequency range	2,400...2,485 MHz
Gain	4 dBi
3 dB beamwidth, horizontal	360°
3 dB beamwidth, vertical	70°
Termination	reverse SMA socket
Dimensions	height: 202 mm, base diameter: 35 mm
Operating temperature	-40...+80 °C
Mounting	M14 connecting nut
Matching cables	1 m cable (included in the scope of supply)

Rod antenna 5 dBi

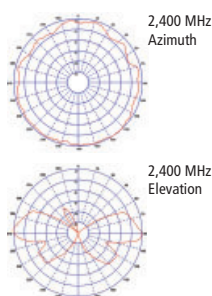

Technical data	ZS6201-0500
Frequency range	2,400...2,485 MHz
Gain	5 dBi
3 dB beamwidth, horizontal	360°
3 dB beamwidth, vertical	70°
Termination	reverse SMA socket
Dimensions	height: 195 mm, base diameter: 12 mm
Operating temperature	-40...+80 °C
Mounting	direct connection, with angle joint
Matching cables	not applicable, direct connection

Directional antenna 18 dBi

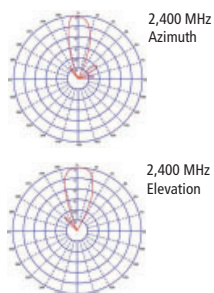

Technical data	ZS6100-1800
Frequency range	2,400...2,485 MHz
Gain	18 dBi
3 dB beamwidth, horizontal	20°
3 dB beamwidth, vertical	20°
Termination	SMA socket
Dimensions	360 mm x 360 mm x 30 mm (H x W x D)
Operating temperature	-40...+80 °C
Mounting	bracket mounting
Matching cables	ZK6000-0102-0020/-0040 (not included in the scope of supply)

Antenna cables

Ordering information	Description
ZK6000-0102-0020	coaxial cable, 50 Ω impedance, with attached connectors (SMA plug and reverse SMA socket), black, 200 cm
ZK6000-0102-0040	coaxial cable, 50 Ω impedance, with attached connectors (SMA plug and reverse SMA socket), black, 400 cm