

# SOLO

## Temperature Controller

Manual Number: SL-USER-M



## ⚡ WARNING ⚡

Thank you for purchasing automation equipment from AutomationDirect.com™, doing business as AutomationDirect. We want your new automation equipment to operate safely. Anyone who installs or uses this equipment should read this publication (and any other relevant publications) before installing or operating the equipment.

To minimize the risk of potential safety problems, you should follow all applicable local and national codes that regulate the installation and operation of your equipment. These codes vary from area to area and usually change with time. It is your responsibility to determine which codes should be followed, and to verify that the equipment, installation, and operation is in compliance with the latest revision of these codes.

At a minimum, you should follow all applicable sections of the National Fire Code, National Electrical Code, and the codes of the National Electrical Manufacturer's Association (NEMA). There may be local regulatory or government offices that can also help determine which codes and standards are necessary for safe installation and operation.

Equipment damage or serious injury to personnel can result from the failure to follow all applicable codes and standards. We do not guarantee the products described in this publication are suitable for your particular application, nor do we assume any responsibility for your product design, installation, or operation.

Our products are not fault-tolerant and are not designed, manufactured or intended for use or resale as on-line control equipment in hazardous environments requiring fail-safe performance, such as in the operation of nuclear facilities, aircraft navigation or communication systems, air traffic control, direct life support machines, or weapons systems, in which the failure of the product could lead directly to death, personal injury, or severe physical or environmental damage ("High Risk Activities"). AutomationDirect specifically disclaims any expressed or implied warranty of fitness for High Risk Activities.

For additional warranty and safety information, see the Terms and Conditions section of our catalog. If you have any questions concerning the installation or operation of this equipment, or if you need additional information, please call us at 770-844-4200.

This publication is based on information that was available at the time it was printed. At AutomationDirect we constantly strive to improve our products and services, so we reserve the right to make changes to the products and/or publications at any time without notice and without any obligation. This publication may also discuss features that may not be available in certain revisions of the product.

## Trademarks

This publication may contain references to products produced and/or offered by other companies. The product and company names may be trademarked and are the sole property of their respective owners. AutomationDirect disclaims any proprietary interest in the marks and names of others.

**Copyright 2007-2018, AutomationDirect.com™ Incorporated  
All Rights Reserved**

No part of this manual shall be copied, reproduced, or transmitted in any way without the prior, written consent of AutomationDirect.com™ Incorporated. AutomationDirect retains the exclusive rights to all information included in this document.

# ⚡ AVERTISSEMENT ⚡

Nous vous remercions d'avoir acheté l'équipement d'automatisation de AutomationDirect.com™, en faisant des affaires comme AutomationDirect. Nous tenons à ce que votre nouvel équipement d'automatisation fonctionne en toute sécurité. Toute personne qui installe ou utilise cet équipement doit lire la présente publication (et toutes les autres publications pertinentes) avant de l'installer ou de l'utiliser.

Afin de réduire au minimum le risque d'éventuels problèmes de sécurité, vous devez respecter tous les codes locaux et nationaux applicables régissant l'installation et le fonctionnement de votre équipement. Ces codes diffèrent d'une région à l'autre et, habituellement, évoluent au fil du temps. Il vous incombe de déterminer les codes à respecter et de vous assurer que l'équipement, l'installation et le fonctionnement sont conformes aux exigences de la version la plus récente de ces codes.

Vous devez, à tout le moins, respecter toutes les sections applicables du Code national de prévention des incendies, du Code national de l'électricité et des codes de la National Electrical Manufacturer's Association (NEMA). Des organismes de réglementation ou des services gouvernementaux locaux peuvent également vous aider à déterminer les codes ainsi que les normes à respecter pour assurer une installation et un fonctionnement sûrs.

L'omission de respecter la totalité des codes et des normes applicables peut entraîner des dommages à l'équipement ou causer de graves blessures au personnel. Nous ne garantissons pas que les produits décrits dans cette publication conviennent à votre application particulière et nous n'assumons aucune responsabilité à l'égard de la conception, de l'installation ou du fonctionnement de votre produit.

Nos produits ne sont pas insensibles aux défaillances et ne sont ni conçus ni fabriqués pour l'utilisation ou la revente en tant qu'équipement de commande en ligne dans des environnements dangereux nécessitant une sécurité absolue, par exemple, l'exploitation d'installations nucléaires, les systèmes de navigation aérienne ou de communication, le contrôle de la circulation aérienne, les équipements de survie ou les systèmes d'armes, pour lesquels la défaillance du produit peut provoquer la mort, des blessures corporelles ou de graves dommages matériels ou environnementaux («activités à risque élevé»). La société AutomationDirect nie toute garantie expresse ou implicite d'aptitude à l'emploi en ce qui a trait aux activités à risque élevé.

Pour des renseignements additionnels touchant la garantie et la sécurité, veuillez consulter la section Modalités et conditions de notre documentation. Si vous avez des questions au sujet de l'installation ou du fonctionnement de cet équipement, ou encore si vous avez besoin de renseignements supplémentaires, n'hésitez pas à nous téléphoner au 770-844-4200.

Cette publication s'appuie sur l'information qui était disponible au moment de l'impression. À la société AutomationDirect, nous nous efforçons constamment d'améliorer nos produits et services. C'est pourquoi nous nous réservons le droit d'apporter des modifications aux produits ou aux publications en tout temps, sans préavis ni quelque obligation que ce soit. La présente publication peut aussi porter sur des caractéristiques susceptibles de ne pas être offertes dans certaines versions révisées du produit.

## Marques de commerce

La présente publication peut contenir des références à des produits fabriqués ou offerts par d'autres entreprises. Les désignations des produits et des entreprises peuvent être des marques de commerce et appartiennent exclusivement à leurs propriétaires respectifs. AutomationDirect nie tout intérêt dans les autres marques et désignations.

**Copyright 2007-2018, AutomationDirect.com™ Incorporated  
Tous droits réservés**

Nulle partie de ce manuel ne doit être copiée, reproduite ou transmise de quelque façon que ce soit sans le consentement préalable écrit de la société AutomationDirect.com™ Incorporated. AutomationDirect conserve les droits exclusifs à l'égard de tous les renseignements contenus dans le présent document.



# SOLO TEMPERATURE CONTROLLER USER MANUAL

Please include the Manual Number and the Manual Issue, both shown below, when communicating with Technical Support regarding this publication.

**Manual Number:** SL-USER-M  
**Issue:** 2nd Edition Rev. D  
**Issue Date:** 04/18

Publication History		
Issue	Date	Description of Changes
First Edition	06/07	Original Issue
Rev. A	09/07	Revised parameter ranges, made corrections, added Index
Rev. B	11/07	Revised analog parameters, updated specifications table
Rev. C	07/08	Revised analog parameters, updated specifications table
Rev D	06/10	Revised PC connection information
Rev. E	10/10	Added ungrounded thermocouple note
Rev. F	12/10	Added note to Analog High and Analog Low Adjustment.
2nd Edition	07/11	Added DC controllers
Rev. A	12/11	Revised wiring diagrams
Rev. B	12/15	Revised Relay output specification for SL4848 and SL4896.
Rev. C	04/18	Revised Chapter 6. Most content included in online help. Comm Port settings updated.
Rev. D	04/18	Added PV Offset parameter tables. Revised manual layout.

# TABLE OF CONTENTS

---



## Chapter 1: Getting Started

<b>Manual Overview</b> .....	1-2
Overview of this Publication .....	1-2
Who Should Read This Manual.....	1-2
Technical Support .....	1-2
Supplemental Manuals .....	1-2
Special Symbols.....	1-2
<b>SOLO Temperature Controller Introduction</b> .....	1-3
General Description.....	1-3
Unpacking.....	1-3
Serial Number Label Information:.....	1-4
Model Number Explanation .....	1-4
<b>SOLO Temperature Controller Specifications</b> .....	1-5

## Chapter 2: Installation and Wiring

<b>Ambient Conditions</b> .....	2-2
<b>Installation Considerations</b> .....	2-2
<b>Mounting Instructions</b> .....	2-3
<b>Controller and Panel Cutout Dimensions</b> .....	2-4
<b>Safety Information</b> .....	2-6
<b>Terminal Identification</b> .....	2-8

SL4824 Series Inputs .....	2-8
SL4824 Series Wiring.....	2-9
SL4848 Series Inputs .....	2-10
SL4848 Series Wiring.....	2-11
SL4896 Series Inputs .....	2-12
SL4896 Series Wiring.....	2-13
SL9696 Series Inputs .....	2-14
SL9696 Series Wiring.....	2-15

### **Chapter 3: Keypad Operation and Setup Parameters**

Display, LED and Keypad.....	3-2
Keypad Operation .....	3-3
Setup Parameter Listing .....	3-4
Regulation Mode Parameters.....	3-7
Operation Mode Parameters.....	3-17
Initial Setting Parameters.....	3-19
Reset to Factory Default.....	3-24

### **Chapter 4: Controller Inputs and Outputs**

Control Input Types.....	4-2
Event Inputs .....	4-3
Control Output Types.....	4-4
Alarm Outputs .....	4-8

### **Chapter 5: Control Modes**

PID Control .....	5-2
On / Off Control .....	5-3
Ramp / Soak Control .....	5-4

Manual Control.....	5–5
Error Display Information.....	5–5

## Chapter 6: Configuration Software

PC Connection .....	6–2
Software Installation .....	6–3
Starting SL-SOFT.....	6–6
SL-SOFT Online Help .....	6–6

## Chapter 7: Modbus Communication

Modbus Protocol .....	7–2
Registers.....	7–2
Connection with the DirectLOGIC PLC.....	7–8
Connection with the <i>C-more</i> and <i>C-more</i> Micro HMI panels .....	7–10

## Appendix: Modbus Address Map for Ramp / Soak Control

Last Step Number.....	A–2
Additional Cycles .....	A–2
Next Pattern Number.....	A–2
Ramp / Soak SV .....	A–3
Ramp / Soak Time .....	A–4

# GETTING STARTED

---



# CHAPTER 1

## In this Chapter...

<b>Manual Overview .....</b>	<b>1-2</b>
Overview of this Publication.....	1-2
Who Should Read This Manual .....	1-2
Technical Support.....	1-2
Supplemental Manuals.....	1-2
Special Symbols .....	1-2
<b>SOLO Temperature Controller Introduction .....</b>	<b>1-3</b>
General Description.....	1-3
Unpacking .....	1-3
Serial Number Label Information:.....	1-4
Model Number Explanation .....	1-4
<b>SOLO Temperature Controller Specifications.....</b>	<b>1-5</b>



## Manual Overview

### Overview of this Publication

The SOLO Temperature Controller User Manual describes the installation, configuration, and methods of operation of the SOLO Temperature Controller.

### Who Should Read This Manual

This manual contains important information for those who will install, maintain, and/or operate any of the SOLO Temperature Controllers.

### Technical Support

**By Telephone: 770-844-4200**  
(Mon.-Fri., 9:00 a.m.-6:00 p.m. E.T.)

**On the Web: [support.automationdirect.com](http://support.automationdirect.com)**

Our technical support group is glad to work with you in answering your questions. If you cannot find the solution to your particular application, or, if for any reason you need additional technical assistance, please call technical support at **770-844-4200**. We are available weekdays from 9:00 a.m. to 6:00 p.m. Eastern Time.

We also encourage you to visit our web site where you can find technical and non-technical information about our products and our company. Visit us at **[www.automationdirect.com](http://www.automationdirect.com)**.

### Supplemental Manuals

If you are familiar with industrial control type devices, you may be able to get up and running with just the aide of the Quick Start Guide that is included with each SOLO Temperature Controller.

### Special Symbols



---

*When you see the “notepad” icon in the left-hand margin, the paragraph to its immediate right will be a special note.*

---



---

**When you see the “exclamation mark” icon in the left-hand margin, the paragraph to its immediate right will be a warning. This information could prevent injury, loss of property, or even death (in extreme cases).**

---

# SOLO Temperature Controller Introduction

## General Description

The SOLO Temperature Controller is a single loop dual output temperature controller that can control both heating and cooling simultaneously. There are four types of control modes: PID, ON / OFF, Manual, and Ramp / Soak control. Depending upon the particular model of controller, the available outputs include relay, voltage pulse, current, and linear voltage. There are up to three alarm outputs available to allow seventeen alarm types in the initial setting mode. SOLO can accept various types of thermocouple, RTD, or analog inputs, and has a built in RS-485 interface using Modbus slave (ASCII or RTU) communication protocol.

Other features include:

- 1/32, 1/16, 1/8 and 1/4 DIN panel sizes
- 2 line x 4 character 7-segment LED display for Process Value (PV): Red color, and Set Point (SV): Green color
- Auto Tuning (AT) function with PID control
- Selectable between °C and °F for thermocouple or RTD inputs
- 0 to 50 °C (32 to 122 °F) operating temperature range
- UL, CUL and CE agency approvals

## Unpacking

After receiving the SOLO Temperature Controller, please check for the following:

- Make sure that the package includes the Controller, the mounting brackets and hardware, a 249 ohm resistor and the Quick Start Guide.
- Inspect the unit to insure it was not damaged during shipment.
- Make sure that the part number indicated on the serial number label corresponds with the part number of your order.

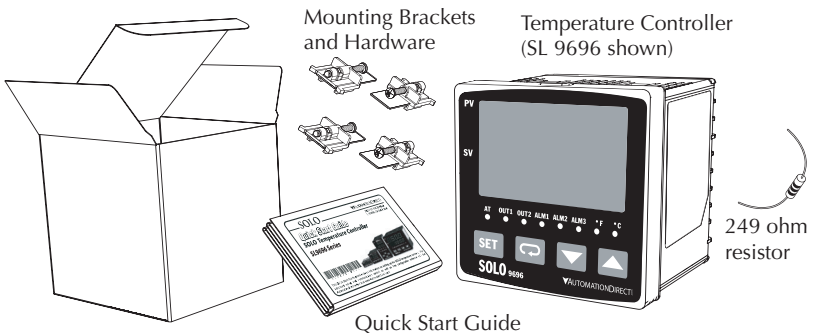

## Serial Number Label Information:

### SL4824 Series Serial Number Label

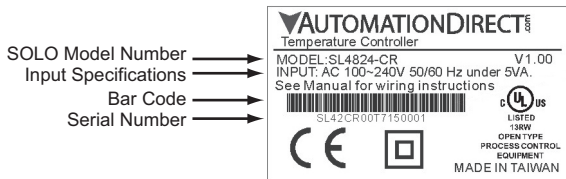

### SL4848, SL4896, and SL9696 Series Serial Number Label



## Model Number Explanation

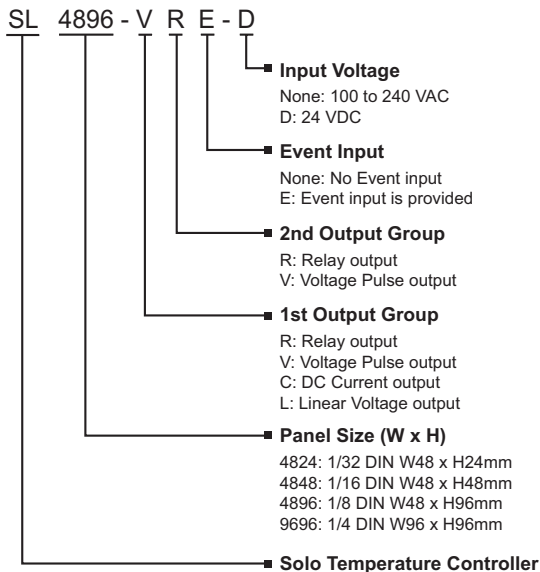

# SOLO Temperature Controller Specifications

Specifications	
<b>Input Power Requirements</b>	100 to 240 VAC 50 / 60 Hz or 24 VDC
<b>Operation Voltage Range</b>	85 to 264 VAC or 21.6 to 26.4 VDC
<b>Power Consumption</b>	5 VA Max
<b>Memory Protection</b>	EEPROM 4K bit, number of writes 100,000
<b>Control Mode</b>	PID, ON/OFF, Ramp / Soak control or Manual
<b>Input Accuracy</b>	Less than $\pm 0.2\%$ full scale (except thermocouple R, S, & B types) Max $\pm 3^\circ$ (thermocouple R, S, & B types)
<b>Vibration Resistance</b>	10 to 55 Hz, 10 m/s <sup>2</sup> for 10 min, each in X, Y and Z directions
<b>Shock Resistance</b>	Max. 300 m/s <sup>2</sup> , 3 times in each 3 axes, 6 directions
<b>Ambient Temperature Range</b>	32°F to 122°F (0°C to 50°C)
<b>Storage Temperature Range</b>	-4°F to 149°F (-20°C to 65°C)
<b>Altitude</b>	2000m or less
<b>Relative Humidity</b>	35% to 80% (non-condensing)
<b>RS-485 Communication</b>	Modbus slave ASCII / RTU protocol
<b>Transmission Speed</b>	2400, 4800, 9600, 19.2K, 38.4K bps
<b>IP Rating</b>	IP65: Complete protection against dust and low pressure spraying water from all directions. (inside suitable enclosure)
<b>Agency Approvals</b>	UL, CUL, CE (UL file number E311366)
<b>Pollution Degree</b>	Degree 2 - Normally, only non-conductive pollution occurs. Temporary conductivity caused by condensation is to be expected
<b>Input Types</b>	
• <b>Thermocouple*</b>	K, J, T, E, N, R, S, B, L, U, TXK
• <b>Platinum RTD</b>	3-wire Pt100, JPt100
• <b>Analog</b>	0-50 mV, 0-5V, 0-10V, 0-20 mA, 4-20 mA (Current input requires the installation of the supplied 249 $\Omega$ resistor)
<b>Input Sampling Rates</b>	
• <b>Thermocouple</b>	400 ms / per scan
• <b>Platinum RTD</b>	400 ms / per scan
• <b>Analog</b>	150 ms / per scan
<b>Control Output Options</b>	
• <b>Relay (R)</b>	SL4824: SPST max. resistive load 3A @ 250 VAC SL4848: SPST max. resistive load 5A @ 250 VAC SL4896, SL9696: SPDT max. resistive load 5A @ 250 VAC SL4824: SPST max. resistive load 3A @ 30 VDC SL4848: SPST max. resistive load 5A @ 30 VDC SL4896, SL9696: SPDT max. resistive load 5A @ 30 VDC
• <b>Voltage Pulse (V)</b>	DC 14V Max, output current 40mA Max
• <b>Current (C)</b>	DC 4-20 mA output (Load resistance: Max 600 $\Omega$ )
• <b>Linear Voltage (L)</b>	DC 0-10V (Load resistance Min 1K $\Omega$ )
<b>*Note: Use only ungrounded thermocouples.</b>	

# INSTALLATION AND WIRING

---



# CHAPTER 2

## In this Chapter...

Ambient Conditions .....	2-2
Installation Considerations.....	2-2
Mounting Instructions.....	2-3
Controller and Panel Cutout Dimensions.....	2-4
Safety Information.....	2-6
Terminal Identification.....	2-8
SL4824 Series Inputs .....	2-8
SL4824 Series Wiring.....	2-9
SL4848 Series Inputs .....	2-10
SL4848 Series Wiring.....	2-11
SL4896 Series Inputs .....	2-12
SL4896 Series Wiring.....	2-13
SL9696 Series Inputs .....	2-14
SL9696 Series Wiring.....	2-15

## Ambient Conditions

Ambient Conditions	
<b>Ambient Temperature Range</b>	32°F to 122°F (0°C to 50°C)
<b>Storage Temperature Range</b>	-4°F to 149°F (-20°C to 65°C)
<b>Relative Humidity</b>	35% to 80% (non-condensing)
<b>Altitude</b>	2000m or lower above sea level, keep from corrosive gas, liquid and dust
<b>Pollution Degree</b>	Degree 2 - Normally, only non-conductive pollution occurs. Temporary conductivity caused by condensation is to be expected
<b>Vibration Resistance</b>	10 to 55 Hz, 10 m/s <sup>2</sup> for 10 min, each in X, Y and Z directions
<b>Shock Resistance</b>	Max. 300 m/s <sup>2</sup> , 3 times in each 3 axes, 6 directions
<b>IP Rating</b>	IP65: Complete protection against dust and low pressure spraying water from all directions when mounted in a suitable enclosure.

## Installation Considerations

Improper installation of the controller will greatly reduce its life. Be sure to observe the following precautions when selecting a mounting location:



**Warning: Failure to observe these precautions may damage the controller and void the warranty!**

- Do not mount the controller near heat-radiating elements or in direct sunlight.
- Do not install the controller in a place subjected to high temperature, high humidity, excessive vibration, corrosive gases or liquids, or airborne dust or metallic particles.
- Do not restrict the air flow to the vent opening on the controller housing
- This controller is an open-type unit and must be placed in an enclosure to ensure proper operation and maintain the IP65 rating.

## Mounting Instructions

### SL4824 Series

Series SL4824 temperature controllers should be mounted through a cutout in an enclosure or panel by using the dimensions shown on page 2–4. The directions for mounting the controller through a cutout are...

1. Insert the temperature controller through the panel cutout.
2. Slide the M3X0.5 nut into the opening in the top of the mounting bracket and insert the M3X0.5 X 30mm mounting screw in the mounting bracket.
3. Slide the mounting bracket onto the controller and push the mounting bracket forward until the bracket stops.
4. Tighten the M3X0.5 X 30mm screw to secure temperature controller in place.

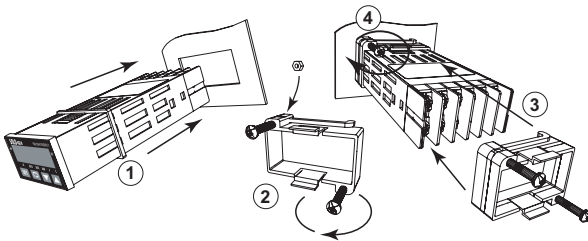

### SL4848, SL4896, SL9696 Series

Series SL4848, SL4896 and SL9696 temperature controllers should be mounted through a cutout in an enclosure or panel by using the dimensions shown on page 2–4 and page 2–5. The directions for mounting the controller through a cutout are...

1. Insert the temperature controller through the panel cutout.
2. Slide the M3X0.5 nut into the opening in the top of the mounting bracket and insert the M3X0.5 X 30mm mounting screw in the mounting bracket.
3. Insert the mounting bracket into the mounting groove at the top and bottom of the controller, and push the mounting bracket forward until the bracket stops.
4. Tighten top and bottom screws evenly to secure temperature controller in place.

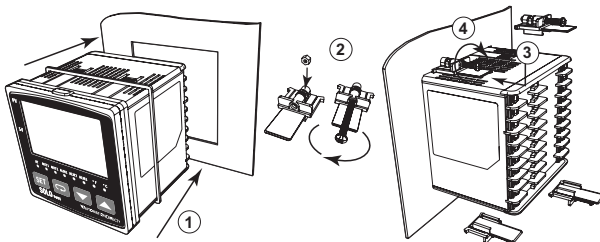

## Controller and Panel Cutout Dimensions

### SL4824 Series

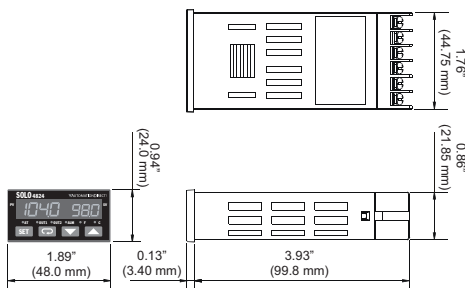

### Minimum Cutout and Spacing

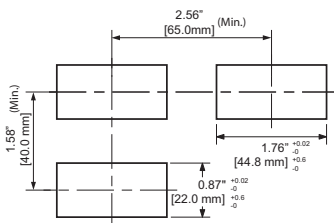

### SL4848 Series

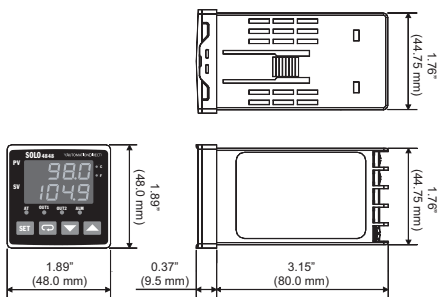

### Minimum Cutout and Spacing

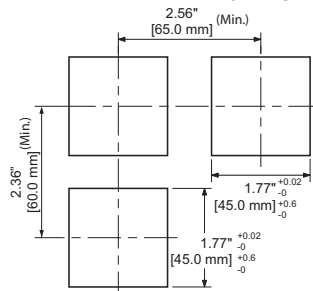



# Controller and Panel Cutout Dimensions, cont'd

## SL4896 Series

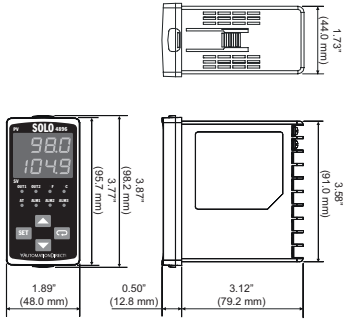

## Minimum Cutout and Spacing

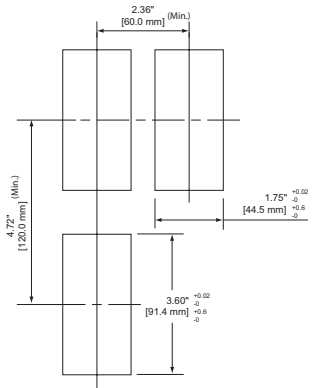

## SL9696 Series

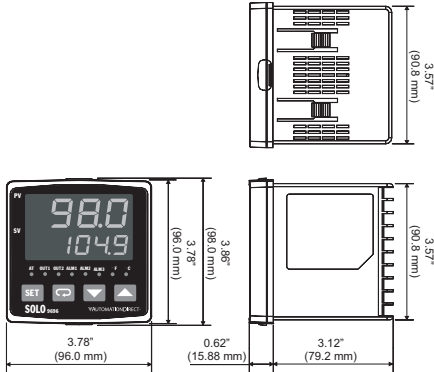

## Minimum Cutout and Spacing

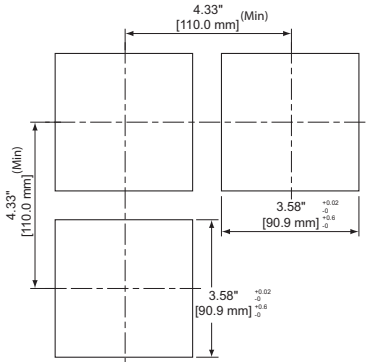

## Safety Information

### DANGER!



**Warning:** To minimize the risk of potential safety problems, you should follow all applicable local and national codes that regulate the installation and operation of your equipment. These codes vary from area to area and it is your responsibility to determine which codes should be followed, and to verify that the equipment, installation, and operation are in compliance with the latest revision of these codes



**Warning:** To prevent electric shock, do not touch the AC terminals while power is supplied to the controller.



**Warning:** This controller is an open-type temperature controller. make sure to evaluate any dangerous application in which a serious human injury or serious property damage may occur.

#### **Wiring Notes: PLEASE READ PRIOR TO INSTALLATION.**

*Equipment damage or serious injury to personnel can result from the failure to follow all applicable codes and standards. We do not guarantee the products described in this publication are suitable for your particular application, nor do we assume any responsibility for your product design, installation, or operation.*

If you have any questions concerning the installation or operation of this equipment, or if you need additional information, please call us at 1-800-633-0405 or 770-844-4200.

This publication is based on information that was available at the time it was printed. At AutomationDirect.com® we constantly strive to improve our products and services, so we reserve the right to make changes to the products and/or publications at any time without notice and without obligation. This publication may also discuss features that may not be available in certain revisions of the product.

1. Always use recommended solder-less terminals: Fork terminal with isolation (M3 screw, width is 7.0mm, hole diameter 3.2mm). Screw size: M3 x 6.5 (With 6.8 x 6.8 square washer). Recommended tightening torque: 0.4 Nm (4kgfcm). Applicable wire: Solid/twisted wire of 2 mm, 12AWG to 24AWG. Choose AutomationDirect fork terminals part numbers BM-00120, BM-00220 or BM-00320 depending on wire size. Be sure to tighten them properly.
2. Protect the controller from dust or foreign objects as they can cause the controller to malfunction.
3. Never modify or disassemble the controller.
4. Do not connect anything to the “Not used” terminals.
5. Make sure all wires are connected to the correct polarity of terminals.
6. Do not install and/or use the controller in places subject to: (a) Dust or corrosive gases and liquid (b) High humidity (c) Vibration or shock (d) EMI / RFI (e) high temperature.
7. Power must be turned off when wiring or changing a sensor.

## Safety Information, cont'd

8. Be sure to use wires that match the thermocouple types when extending or connecting thermocouple wires.
9. Use wires with correct resistance when extending or connecting a RTD.
10. Keep the wire as short as possible when wiring a RTD to the controller and route power wires as far as possible from sensor wires to prevent interference and induced noise.
11. This controller is an open-type unit and must be placed in an enclosure to ensure proper operation and maintain the IP65 rating.
12. Make sure power cables and signals from instruments are all installed properly before energizing the controller, otherwise serious damage may occur.
13. To prevent electric shock, do not touch the terminals on the controller or try to repair the controller when power is applied.
14. Do not use acid or alkaline liquids for cleaning. Use a soft, dry cloth to clean the controller.
15. This instrument is not furnished with a power switch or fuse. Therefore, if a fuse or power switch is required, install the protection close to the instrument. Recommended fuse rating: Rated voltage 250 V, Rated current 1 A. Fuse type: Time-delay fuse. See the AutomationDirect catalog for the appropriate fuse for the specific application.
16. Note: This controller does not provide overcurrent protection. Use of this product requires that suitable overcurrent protection device(s) must be added to ensure compliance with all relevant electrical standards and codes. (Rated 250 V, 15 Amps max). A suitable disconnecting device should be provided near the controller in the end-use installation.

## Terminal Identification

### SL4824 Series Inputs

#### Power Input

AC Models Power Input

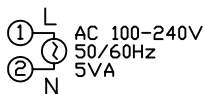

DC Models Power Input

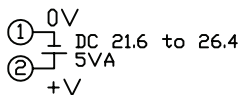

#### Sensor Input

0 – 10 VDC

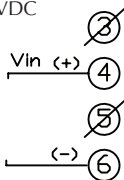

4–20 mA  
For 4~20mA sensor input install supplied 249Ω resistor.

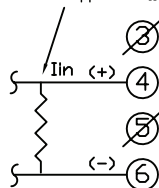

2-wire RTD

Install jumper when using 2 wire RTD

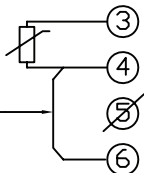

3-wire RTD

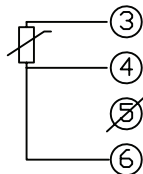

Thermocouple

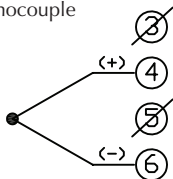

## Terminal Identification cont'd

## SL4824 Series Wiring

SL4824-RR

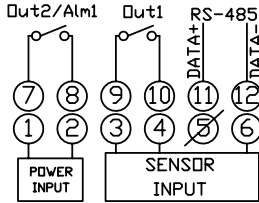

SL4824-VR

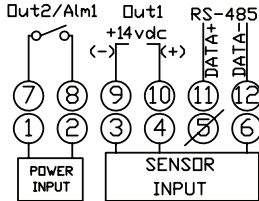

SL4824-CR

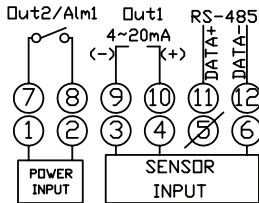

SL4824-LR

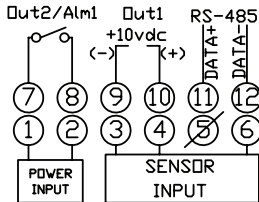

## Terminal Identification, cont'd

### SL4848 Series Inputs

#### Power Input

AC Models Power Input

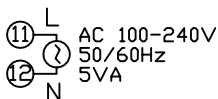

DC Models Power Input

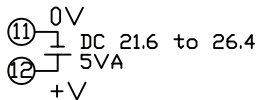

#### Sensor Input

0 – 10 VDC

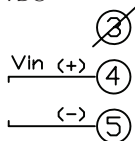

4~20 mA

For 4~20mA sensor input install supplied 249Ω resistor.

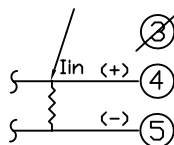

2-wire RTD

Install jumper when using 2 wire RTD

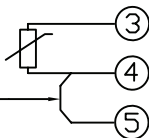

3-wire RTD

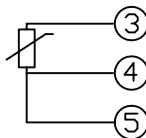

Thermocouple

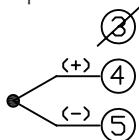

## Terminal Identification, cont'd

## SL4848 Series Wiring

SL4848-RR

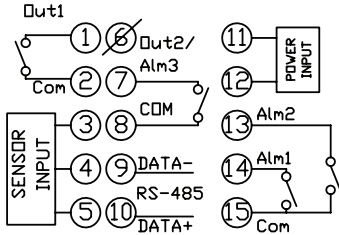

SL4848-LV &amp; SL4848-VV

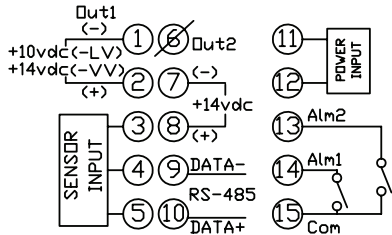

SL4848-VR

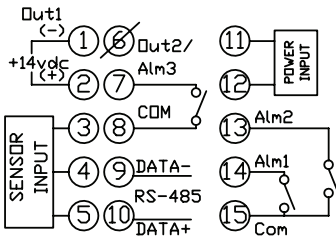

SL4848-CR

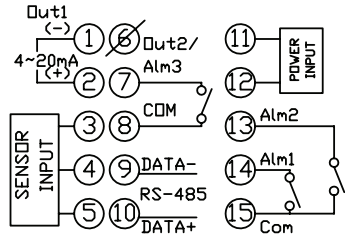

SL4848-CV

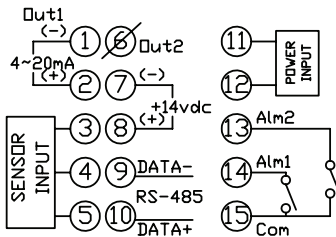

SL4848-LR

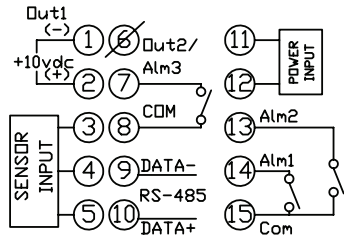

## Terminal Identification, cont'd

### SL4896 Series Inputs

#### Power Input

AC Models Power Input

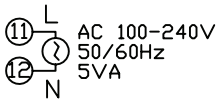

DC Models Power Input

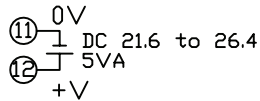

#### Sensor Input

0 – 10 VDC

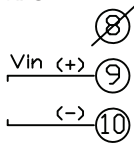

4-20 mA

For 4-20mA sensor input install supplied 249Ω resistor.

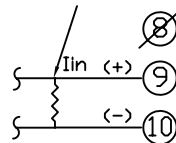

2-wire RTD

Install jumper when using 2 wire RTD

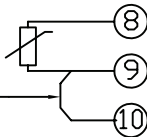

3-wire RTD

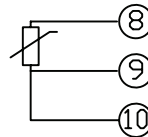

Thermocouple

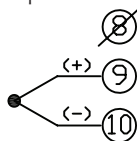



# Terminal Identification, cont'd

## SL4896 Series Wiring

SL4896-RRE

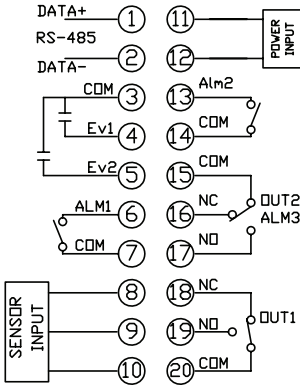

SL4896-CRE

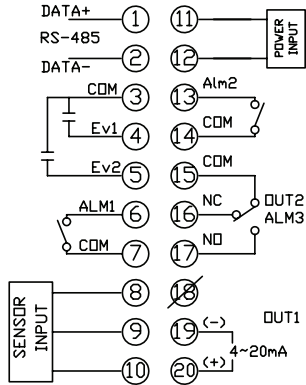

SL4896-VRE

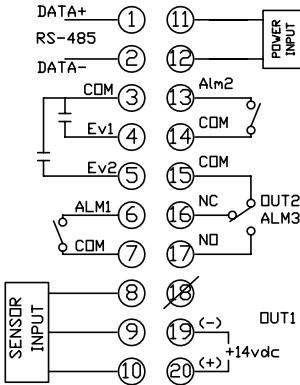

SL4896-LRE

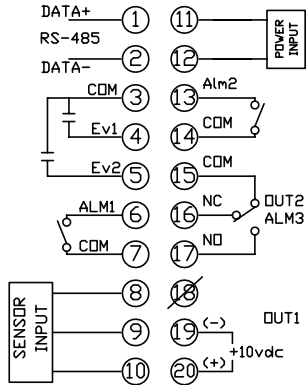

## Terminal Identification, cont'd

### SL9696 Series Inputs

#### Power Input

##### AC Models Power Input

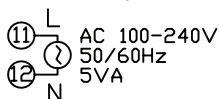

##### DC Models Power Input

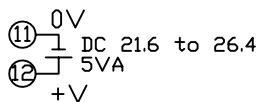

##### 0 – 10 VDC

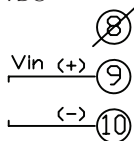

##### 4~20 mA

For 4~20mA sensor input install supplied 249Ω resistor.

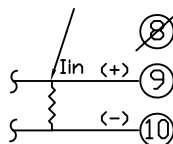

##### 2-wire RTD

Install jumper when using 2 wire RTD

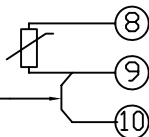

##### 3-wire RTD

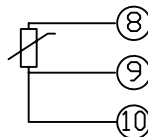

##### Thermocouple

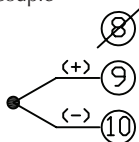

## Terminal Identification, cont'd

## SL9696 Series Wiring

SL9696-RRE

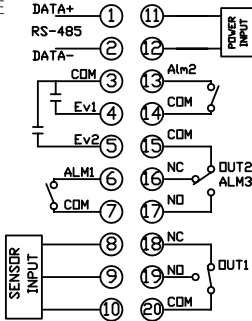

SL9696-LRE

SL9696-VRE

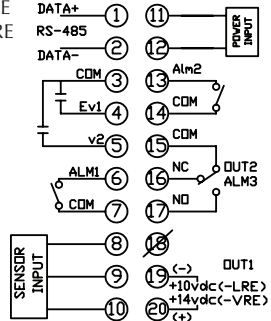

SL9696-CRE

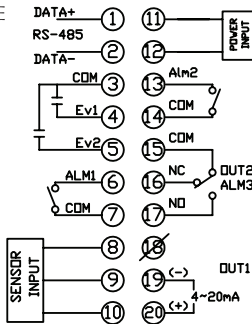

SL9696-CVE

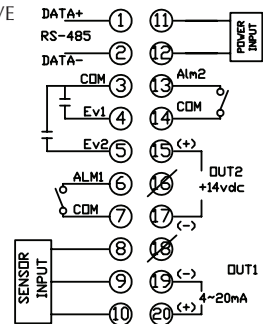

SL9696-VVE

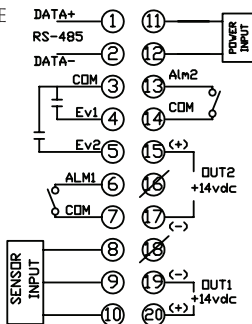

SL9696-LVE

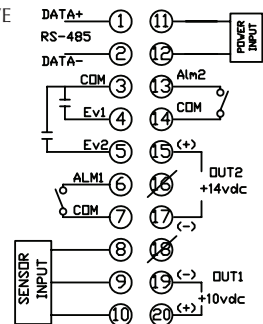

# KEYPAD OPERATION AND SETUP PARAMETERS

---



# CHAPTER 3

## In this Chapter...

Display, LED and Keypad.....	3-2
Keypad Operation .....	3-3
Setup Parameter Listing.....	3-4
Regulation Mode Parameters.....	3-7
Operation Mode Parameters.....	3-17
Initial Setting Parameters.....	3-19
Reset to Factory Default.....	3-24

## Display, LED and Keypad

The SOLO temperature controller has a two color seven segment LED display, four types of LED status indicators and four function buttons.

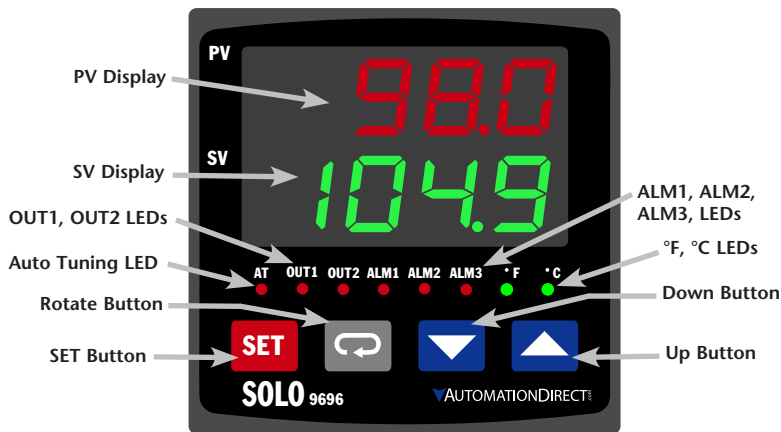

### PV Display

The Process Value Display. Displays the value from the input source or the parameter source.

### SV Display

The Set Value Display. Displays the set point of the process, the parameter operation read value, manipulated variable, or the set value of the parameter.

### AT LED Indicator

Auto Tuning LED flashes when the Auto Tuning operation is ON.

### OUT1, OUT2 LED Indicators

Output 1 and Output 2 LED indicators light when the output is ON.

### °F, °C LED Indicators

Temperature unit LED. °C: Celsius, °F: Fahrenheit

### ALM1, ALM2, ALM3 LED Indicators

Alarm output LED indicators light when appropriate alarm is activated. ALM2 and ALM3 indicators are available on series SL4896 and SL9696 only.

# Keypad Operation

## Function Buttons

**SET**

### SET Button

Press the SET button to select the desired function mode and confirm the setting value.



### Rotate Button

Press the Rotate button to select parameters within the function mode.



### Down Button

Press the Down button to decrease values displayed on the SV display. Hold down this button to speed up the decrement.



### Up Button

Press the Up button to increase values displayed on the SV display. Hold down this button to speed up the increment.

## Initial Power up

When power is first applied to the temperature controller, the module information splash screen appears. This screen shows the firmware version on the PV display and the two output types for that particular model on the SV display. After three seconds, the controller will automatically proceed to the Operation mode main screen.

## Keypad Operation

The temperature controller has three function modes: Initial Setting mode, Operation mode and Regulation mode. Press and hold the SET button for three seconds to go into the Initial Setting mode. Press the SET button for less than three seconds to access the Regulation mode. Press the Rotate button while inside any of the three function modes to scroll through the individual parameters for each function mode. Use the Up and Down buttons to change the individual parameter values. Pressing the SET button saves the parameter values. Press the SET button again to return the controller to the Operation mode main screen.

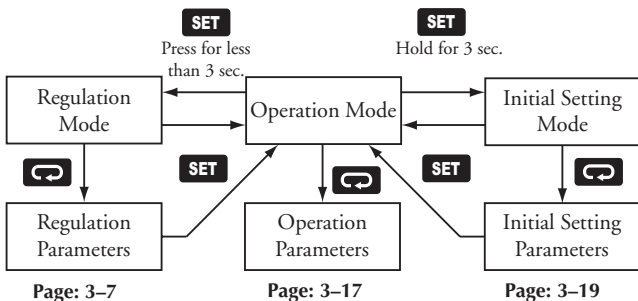

## Setup Parameter Listing













### Regulation Mode Parameters

Press the **SET** button to access these parameters.

Regulation Mode Parameter Availability																	
ID #	Display	Parameter Name	Controller Type						Control Mode				Heating / Cooling				
			RR(E)	VR(E)	W(E)	CR(E)	CV(E)	LR(E)	LV(E)	PID	ON /OFF	Manual	Ramp / Soak	Heating	Cooling	Heating / Cooling	Cooling / Heating
P1-1	<b>AL</b>	Auto Tuning	✓	✓	✓	✓	✓	✓	✓	✓	-	-	-	✓	✓	✓	✓
P1-2	<b>PdIn</b>	PID Parameter Group	✓	✓	✓	✓	✓	✓	✓	✓	-	-	✓	✓	✓	✓	✓
P1-3	<b>SVn</b>	Target SV	✓	✓	✓	✓	✓	✓	✓	✓	-	-	✓	✓	✓	✓	✓
P1-4	<b>Pn</b>	Proportion Band	✓	✓	✓	✓	✓	✓	✓	✓	-	-	✓	✓	✓	✓	✓
P1-5	<b>In</b>	Integral Time	✓	✓	✓	✓	✓	✓	✓	✓	-	-	✓	✓	✓	✓	✓
P1-6	<b>dIn</b>	Derivative Time	✓	✓	✓	✓	✓	✓	✓	✓	-	-	✓	✓	✓	✓	✓
P1-7	<b>PdOF</b>	PD Control Offset	✓	✓	✓	✓	✓	✓	✓	✓	-	-	✓	✓	✓	✓	✓
P1-8	<b>CoFn</b>	Integral Offset	✓	✓	✓	✓	✓	✓	✓	✓	-	-	✓	✓	✓	✓	✓
P1-9	<b>HtS</b>	Heating Hysteresis	✓	✓	✓	✓	✓	✓	✓	-	✓	-	-	✓	-	✓	✓
P1-10	<b>CtS</b>	Cooling Hysteresis	✓	✓	✓	✓	✓	✓	✓	-	✓	-	-	-	✓	✓	✓
P1-11	<b>HtPd</b>	Output 1 Heating Period	✓	✓	✓	✓	✓	✓	✓	✓	-	✓	✓	✓	-	✓	-
P1-12	<b>CtPd</b>	Output 1 Cooling Period	✓	✓	✓	✓	✓	✓	✓	✓	-	✓	✓	-	✓	-	✓
P1-13	<b>HtCPd</b>	Output 2 Period	✓	✓	✓	✓	✓	✓	✓	✓	-	✓	✓	-	-	✓	✓
P1-14	<b>CoEF</b>	Proportion Band Coefficient	✓	✓	✓	✓	✓	✓	✓	✓	-	-	✓	-	-	✓	✓
P1-15	<b>DEAd</b>	Dead Band	✓	✓	✓	✓	✓	✓	✓	✓	✓	-	✓	-	-	✓	✓
P1-16	<b>tPOF</b>	PV Offset	✓	✓	✓	✓	✓	✓	✓	✓	✓	✓	✓	✓	✓	✓	✓
P1-17	<b>CHL</b>	Analog High Adjustment	-	-	-	✓	✓	✓	✓	✓	✓	✓	✓	✓	✓	✓	✓
P1-18	<b>CLL</b>	Analog Low Adjustment	-	-	-	✓	✓	✓	✓	✓	✓	✓	✓	✓	✓	✓	✓

## Operation Mode Parameters

Press the  button to access these parameters.

Operation Mode Parameter Availability																
ID #	Display	Parameter Name	Controller Type						Control Mode				Heating / Cooling			
			RR(E)	VR(E)	VV(E)	CR(E)	CV(E)	LR(E)	LV(E)	PID	ON /OFF	Manual	Ramp / Soak	Heating	Cooling	Heating / Cooling
P2-1		Run / Stop	✓	✓	✓	✓	✓	✓	✓	✓	✓	✓	✓	✓	✓	✓
P2-2		Starting Ramp / Soak Pattern	✓	✓	✓	✓	✓	✓	✓	-	-	-	✓	✓	✓	✓
P2-3		Decimal Point Position	✓	✓	✓	✓	✓	✓	✓	✓	✓	✓	✓	✓	✓	✓
P2-4		Alarm 1 High Limit	✓	✓	✓	✓	✓	✓	✓	✓	✓	✓	✓	✓	✓	✓
P2-5		Alarm 1 Low Limit	✓	✓	✓	✓	✓	✓	✓	✓	✓	✓	✓	✓	✓	✓
P2-6		Alarm 2 High Limit	✓	✓	✓	✓	✓	✓	✓	✓	✓	✓	✓	✓	✓	✓
P2-7		Alarm 2 Low Limit	✓	✓	✓	✓	✓	✓	✓	✓	✓	✓	✓	✓	✓	✓
P2-8		Alarm 3 High Limit	✓	✓	✓	✓	✓	✓	✓	✓	✓	✓	✓	✓	-	-
P2-9		Alarm 3 Low Limit	✓	✓	✓	✓	✓	✓	✓	✓	✓	✓	✓	✓	-	-
P2-10		Lock Mode	✓	✓	✓	✓	✓	✓	✓	✓	✓	✓	✓	✓	✓	✓
P2-11		Output 1 Level	✓	✓	✓	✓	✓	✓	✓	✓	✓	✓	✓	✓	✓	✓
P2-12		Output 2 Level	✓	✓	✓	✓	✓	✓	✓	✓	✓	✓	-	-	✓	✓



## Initial Setting Parameters

Press the **SET** button for more than three seconds to access these parameters.

Initial Setting Mode Parameter Availability																	
ID #	Display	Parameter Name	Controller Type						Control Mode			Heating / Cooling					
			RR(E)	VR(E)	VV(E)	CR(E)	CV(E)	LR(E)	LV(E)	PID	ON/OFF	Manual	Ramp / Soak	Heating	Cooling	Heating / Cooling	Cooling / Heating
P3-1	INPE	Input Type	✓	✓	✓	✓	✓	✓	✓	✓	✓	✓	✓	✓	✓	✓	✓
P3-2	TEMPn	Temperature Unit	✓	✓	✓	✓	✓	✓	✓	✓	✓	✓	✓	✓	✓	✓	✓
P3-3	EP-H	Input Range High	✓	✓	✓	✓	✓	✓	✓	✓	✓	✓	✓	✓	✓	✓	✓
P3-4	EP-L	Input Range Low	✓	✓	✓	✓	✓	✓	✓	✓	✓	✓	✓	✓	✓	✓	✓
P3-5	CTRL	Control Mode	✓	✓	✓	✓	✓	✓	✓	✓	✓	✓	✓	✓	✓	✓	✓
P3-6	PATn	Ramp / Soak Pattern*	✓	✓	✓	✓	✓	✓	✓	✓	✓	✓	✓	✓	✓	✓	✓
P3-7	S-HC	Heating / Cooling	✓	✓	✓	✓	✓	✓	✓	✓	✓	✓	✓	✓	✓	✓	✓
P3-8	ALARM	Alarm 1	✓	✓	✓	✓	✓	✓	✓	✓	✓	✓	✓	✓	✓	✓	✓
P3-9	ALARM2	Alarm 2	✓	✓	✓	✓	✓	✓	✓	✓	✓	✓	✓	✓	✓	✓	✓
P3-10	ALARM3	Alarm 3	✓	✓	✓	✓	✓	✓	✓	✓	✓	✓	✓	✓	✓	✓	✓
P3-11	SALARM	System Alarm	✓	✓	✓	✓	✓	✓	✓	✓	✓	✓	✓	✓	✓	✓	✓
P3-12	COSSH	On-Line Configuration	✓	✓	✓	✓	✓	✓	✓	✓	✓	✓	✓	✓	✓	✓	✓
P3-13	C-SL	Modbus Protocol	✓	✓	✓	✓	✓	✓	✓	✓	✓	✓	✓	✓	✓	✓	✓
P3-14	C-no	Network Address	✓	✓	✓	✓	✓	✓	✓	✓	✓	✓	✓	✓	✓	✓	✓
P3-15	bPS	Baud Rate	✓	✓	✓	✓	✓	✓	✓	✓	✓	✓	✓	✓	✓	✓	✓
P3-16	LEN	Bit Length	✓	✓	✓	✓	✓	✓	✓	✓	✓	✓	✓	✓	✓	✓	✓
P3-17	P-ty	Parity	✓	✓	✓	✓	✓	✓	✓	✓	✓	✓	✓	✓	✓	✓	✓
P3-18	STOP	Stop Bit	✓	✓	✓	✓	✓	✓	✓	✓	✓	✓	✓	✓	✓	✓	✓
<i>*Once a Ramp / Soak pattern (P3-6) is selected, the following parameters are available.</i>																	
P3-19	SPmn	Ramp / Soak SV	✓	✓	✓	✓	✓	✓	✓	-	-	-	✓	✓	✓	✓	✓
P3-20	TCmn	Ramp / Soak Time	✓	✓	✓	✓	✓	✓	✓	-	-	-	✓	✓	✓	✓	✓
P3-21	PS4n	Last Step Number	✓	✓	✓	✓	✓	✓	✓	-	-	-	✓	✓	✓	✓	✓
P3-22	CYCn	Additional Cycles	✓	✓	✓	✓	✓	✓	✓	-	-	-	✓	✓	✓	✓	✓
P3-23	LCn	Next Pattern Number	✓	✓	✓	✓	✓	✓	✓	-	-	-	✓	✓	✓	✓	✓

## Regulation Mode Parameters

Press the **SET** button to access these parameters.

**AL****Auto Tuning****ID Number P1-1**

Range: On - Auto Tuning activated  
Off - Auto Tuning deactivated

When this parameter is set to On, the controller begins auto tuning. After auto tuning is complete, the parameter is set to Off automatically. If this parameter is set to Off during the auto tuning process, the controller stops the auto tuning process immediately and does not change any PID parameter.

**PIDn****PID Parameter Group****ID Number P1-2**

This parameter name will be displayed as one of the following.

- PID0** PID Parameter Group 0
- PID1** PID Parameter Group 1
- PID2** PID Parameter Group 2
- PID3** PID Parameter Group 3
- PID4** PID Parameter Group Auto Select
- PID** PID Parameter Group for Event 2 Input

Range: PID0 to PID4

The SOLO controller can store up to 4 PID parameter groups (**PID0** - **PID3**) for regular operation. The PID Parameter Group parameter sets which PID group (**PID0** - **PID3**) to use for control. The SV display shows the Target SV assigned to the PID group. (For more information about the Target SV, refer to P1-3 Target SV)

When **PID4** is selected as the PID parameter group, the controller automatically chooses the one PID parameter group (**PID0** - **PID3**) that has a Target SV that is the nearest to the SV set by the operator and uses that group for control.

**PID** is a special PID parameter group for the SL4896 and SL9696 series controllers Event inputs. This is the PID group that the controller uses when the Event 2 input is on. To configure the PID parameter for this parameter group, the Event 2 input must be active.

**SVn****Target SV****ID Number P1-3**

This parameter name will be displayed as one of the following. Only the Target SV for the selected PID Parameter Group (**PID0**, P1-2) will be displayed when accessing this parameter.

<b>SV0</b>	Target SV of PID Parameter Group 0
<b>SV1</b>	Target SV of PID Parameter Group 1
<b>SV2</b>	Target SV of PID Parameter Group 2
<b>SV3</b>	Target SV of PID Parameter Group 3
<b>SV</b>	Target SV of PID Parameter Group for Event 2 Input

Range: -99.9 to 999.9

(For more information about the parameter groups, refer to P1-2 PID Parameter Group.)

The Target SV is the setting value that each parameter group works toward. When the Target SV is the closest to the SV of the PID groups, this value is used to select which tuning parameters are used by the controller. The controller can store up to four PID parameter groups (**PCD0**, - **PCD3**) for regular operation. One of the PID parameter groups can be selected manually, or the controller selects the PID parameter group that has a Target SV that is the nearest to the SV set by the operator. If there are two or more PID parameter groups that have SV values equally close to the current PV, the controller uses the lowest number parameter group (eg. If parameter groups 0 - 3 have the same Target SV, the controller uses the parameter group 0).

The parameter **SV** is the Target SV of the PID parameter group for Event 2 input. This parameter is only displayed when the Event 2 input is on. The Event 2 input is only available on the SL4896 and SL9696 series controllers.

### **Pn** Proportion Band ID Number P1-4

This parameter name will be displayed as one of the following. Only the Proportion Band for the selected PID Parameter Group (**PCD0**, P1-2) will be displayed when accessing this parameter.

<b>P0</b>	Proportion Band of PID Parameter Group 0
<b>P1</b>	Proportion Band of PID Parameter Group 1
<b>P2</b>	Proportion Band of PID Parameter Group 2
<b>P3</b>	Proportion Band of PID Parameter Group 3
<b>P</b>	Proportion Band of PID Parameter Group for Event 2 Input

Range: 0.1 to 999.9

(For more information about the parameter groups, refer to P1-2 PID Parameter Group.)





The Proportion Band is a parameter group used for PID control. The controller can store up to four PID parameter groups (**PCD0**, - **PCD3**) for regular operation. One of the PID parameter groups can be selected manually, or the controller selects the PID parameter group that has a Target SV that is the nearest to the SV set by the operator.

The parameter **P** is the Proportion Band of the PID parameter group for

Event 2 input. This parameter is only displayed when the Event 2 input is on. The Event 2 input is only available on the SL4896 and SL9696 series controllers.

### Integral Time ID Number P1-5

This parameter name will be displayed as one of the following. Only the Integral Time for the selected PID Parameter Group (P1-d0, P1-2) will be displayed when accessing this parameter.

-  Integral Time of PID Parameter Group 0
-  Integral Time of PID Parameter Group 1
-  Integral Time of PID Parameter Group 2
-  Integral Time of PID Parameter Group 3
-  Integral Time of PID Parameter Group for Event 2 Input

Range: 0 to 9999 (Sec)





(For more information about the parameter groups, refer to P1-2 PID Parameter Group.)

The Integral Time is a parameter group used for PID control. The controller can store up to four PID parameter groups (P1-d0, -P1-d3) for regular operation. One of the PID parameter groups can be selected manually, or the controller selects the PID parameter group that has a Target SV that is the nearest to the SV set by the operator.

The parameter  is the Integral Time of the PID parameter group for Event 2 input. This parameter is only displayed when the Event 2 input is on. The Event 2 input is only available on the SL4896 and SL9696 series controllers.

### Derivative Time ID Number P1-6

This parameter name will be displayed as one of the following. Only the Derivative Time for the selected PID Parameter Group (P1-d0, P1-2) will be displayed when accessing this parameter.

-  Derivative Time of PID Parameter Group 0
-  Derivative Time of PID Parameter Group 1
-  Derivative Time of PID Parameter Group 2
-  Derivative Time of PID Parameter Group 3
-  Derivative Time of PID Parameter Group for Event 2 Input

Range: 0 to 9999 (Sec)

(For more information about the parameter groups, refer to P1-2 PID Parameter Group.)

The Derivative Time is a parameter group used for PID control. The controller can store up to four PID parameter groups (P1-d0, -P1-d3) for regular operation. One of the PID parameter groups can be selected manually, or the controller selects the PID parameter group that has a

Target SV that is the nearest to the SV set by the operator.

The parameter **DT** is the Derivative Time of the PID parameter group for Event 2 input. This parameter is only displayed when the Event 2 input is on. The Event 2 input is only available on the SL4896 and SL9696 series controllers.

**PDof**

**PD Control Offset**

**ID Number P1-7**

Range: 0.0 to 100.0 (%)

The PD Control Offset parameter is available when the P or PD control is selected [Integral Time parameter (**ITn**, P1-5) is zero].

This parameter defines the offset of the output. When the P or PD control is used, the control cannot stabilize the PV at the SV because the output is zero when the PV is equal to the SV. This parameter modifies the output level when the PV is equal to the SV.

**IOFn**

**Integral Offset**

**ID Number P1-8**

This parameter name will be displayed as one of the following.

**IOF0**

Integral Offset of PID Parameter Group 0

**IOF1**

Integral Offset of PID Parameter Group 1

**IOF2**

Integral Offset of PID Parameter Group 2

**IOF3**

Integral Offset of PID Parameter Group 3

**IOF**

Integral Offset of PID Parameter Group for Event 2 Input

Range: 0.0 to 100.0 (%)

(For more information about the parameter groups, refer to PID Parameter Group, P1-2.)

The Integral Offset parameter is available when the PI or PID control is selected. [Integral Time parameter (**ITn**, P1-5) is not zero.]

The Auto Tuning process will decide the offset value automatically.

If this parameter is not used (**IOF** = 0), the output is zero when the PV is equal to the SV. If the Integral Time parameter (**ITn**, P1-5) is used only to eliminate the steady error, it may take a long time to reach the SV because it needs time to accumulate the error. In this case, this parameter is useful. This parameter defines the default output level on start up. It will improve the speed that the PV reaches the SV.

The parameter **IOF** is the Integral Offset of the PID parameter group for Event 2 input. This parameter is only displayed when the Event 2 input is on. The Event 2 input is only available on the SL4896 and SL9696 series controllers.

**HLS**

**Heating Hysteresis**

**ID Number P1-9**

Range: 0.0 to 999.9

The Heating Hysteresis parameter defines the amount that the PV must go below the SV before the output turns on. This parameter is available only for On / Off control with an output programmed for heating.

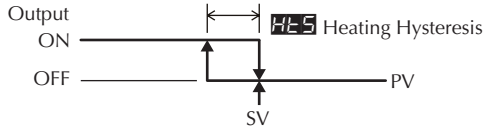

**CLS**

**Cooling Hysteresis**

**ID Number P1-10**

Range: 0.0 to 999.9

The Cooling Hysteresis parameter defines the amount that the PV must go above the SV before the output turns on. This parameter is available only for On / Off control with an output programmed for cooling.

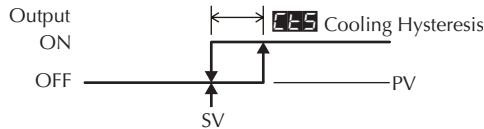

**HLPd**

**Output 1 Heating Period**

**ID Number P1-11**

Range: 0.5 to 99 seconds

The Output 1 Heating parameter defines one output period or the duration of one on / off cycle for Output 1.



This parameter is available when Output 1 is programmed as a heating output in the PID or Ramp / Soak mode.

**CLPd**

**Output 1 Cooling Period**

**ID Number P1-12**

Range: 0.5 to 99 seconds

The Output 1 Cooling parameter defines one output period or the duration of one on / off cycle for Output 1.



This parameter is available when Output 1 is programmed as a cooling output in the PID or Ramp / Soak mode.

**HCPd**

### Output 2 Period

ID Number P1-13

Range: 0.5 to 99 seconds

The Output 1 Cooling parameter defines one output period or the duration of one on / off cycle for Output 2.

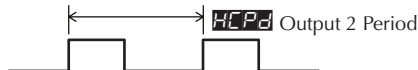

This parameter is available when Output 2 is programmed as a heating or cooling output in the PID or Ramp / Soak mode.

**COEF**

### Proportion Band Coefficient

ID Number P1-14

Range: 0.01 to 99.99

This Proportion Band Coefficient parameter is available when a dual output mode (heating and cooling) is selected. This parameter allows the second output control to have a different proportional setting than the first output control. The first output control proportional band setting is multiplied by this parameter to create a proportional band setting for the second output control.

(First Output) Proportion Band \* Proportion Band Coefficient = Second Proportional Band

(Pn, P1-4)

(COEF, P1-14)

**DEAD**

### Dead Band

ID Number P1-15

Range: The range varies according to the Decimal Point Position (SP, P2-3).

<b>SP</b>	0	1	2	3
<b>DEAD</b>	-99 to 999	-99.9 to 999.9	-9.99 to 99.99	-9.999 to 9.999

The dead band zone is the area around the SV where the output is not effected by the proportional control value (PV). For PID control, as long as the PV remains within the dead band zone, the output is not affected by the proportional control. The integral and derivative controls ignore the dead band setting and may cause the output to be on within the dead band zone.

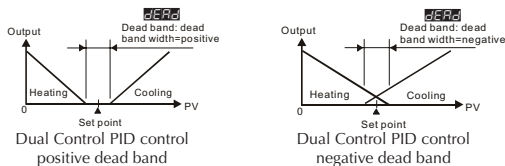

For On / Off type control the Dead Band parameter defines the area around the SV where the output remains off. The PV must go beyond the dead band range in order for either output 1 or output 2 to turn on.

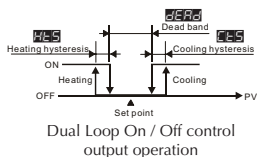

**EPoF**

**PV Offset**

**ID Number P1-16**

Range: The range varies according to the Decimal Point Position (SP, P2-3).

<b>SL4824</b>				
	Decimal Position			
<b>EPoF</b>	0 (****)	1 (*.***)	2 (**.**)	3 (**.*)
0~50 mV	0	0.0	00.00	0.000
4~20 mA	0	0.0	00.00	n/a
0~20 mA	0	0.0	00.00	n/a
0V~10V	0	0.0	00.00	n/a
0V~5V	0	0.0	00.00	n/a
(Pt100)	0	0.0	n/a	n/a
(JPt100)	0	0.0	n/a	n/a
Thermocouple type TXK	0.0	0.0	n/a	n/a
Thermocouple type U	0.0	0.0	n/a	n/a
Thermocouple type L	0.0	0.0	n/a	n/a
Thermocouple type B	0.0	n/a	n/a	n/a
Thermocouple type S	0.0	n/a	n/a	n/a
Thermocouple type R	0.0	n/a	n/a	n/a
Thermocouple type N	0.0	0.0	n/a	n/a
Thermocouple type E	0.0	0.0	n/a	n/a
Thermocouple type T	0.0	0.0	n/a	n/a
Thermocouple type J	0.0	0.0	n/a	n/a
Thermocouple type K	0.0	0.0	n/a	n/a



SL4848 / SL4896 / SL9696				
EPOF	Decimal Position			
	0 (****)	1 (*.***)	2 (**.**)	3 (**.*)
0~50 mV	0	0.0	00.00	00.00
4~20 mA	0	0.0	00.00	00.00
0~20 mA	0	0.0	00.00	00.00
0V~10V	0	0.0	00.00	00.00
0V~5V	0	0.0	00.00	00.00
(Pt100)	0	0.0	n/a	n/a
(JPt100)	0	0.0	n/a	n/a
Thermocouple type TXK	0.0	0.0	n/a	n/a
Thermocouple type U	0.0	0.0	n/a	n/a
Thermocouple type L	0.0	0.0	n/a	n/a
Thermocouple type B	0.0	n/a	n/a	n/a
Thermocouple type S	0.0	n/a	n/a	n/a
Thermocouple type R	0.0	n/a	n/a	n/a
Thermocouple type N	0.0	0.0	n/a	n/a
Thermocouple type E	0.0	0.0	n/a	n/a
Thermocouple type T	0.0	0.0	n/a	n/a
Thermocouple type J	0.0	0.0	n/a	n/a
Thermocouple type K	0.0	0.0	n/a	n/a

This parameter is used to add an offset value to the PV.



### Analog High Adjustment

ID Number P1-17

The Analog High Adjustment parameter is used to adjust the actual analog output value when the output is 100%. To set up this parameter, place the SOLO controller in the Manual control mode and set the Output 1 Level (OLE, P2-11) to 100% then increase / decrease the parameter value to get the desired analog output value.

The tables below show the approximate Analog High Adjustment values needed to obtain the desired output value. The actual controller output will vary. Check and adjust the values until the desired output level is achieved.

Current Output								
	0mA	1mA	2mA	3mA	4mA	5mA	6mA	7mA
	-7198	-6838	-6478	-6118	-5758	-5398	-5038	-4678
	8mA	9mA	10mA	11mA	12mA	13mA	14mA	15mA
	-4319	-3959	-3599	-3239	-2879	-2519	-2159	-1799
	16mA	17mA	18mA	19mA	20mA			
	-1440	-1080	-720	-360	0			

Voltage Output								
	0V	1V	2V	3V	4V	5V	6V	7V
	-7589	-6830	-6071	-5312	-4553	-3795	-3036	-2277
	8V	9V	10V					
	-1518	-758	0					

Note: When decreasing the parameter value for Analog High Adjustment below -1999, the SOLO display will “roll over” to -0, indicating a value of -2000. Two “roll overs” equal a value of -4000 and so forth. For example, to enter a value of -5312 for Analog High Adjustment, hold the button until the SOLO display “rolls over” two times and the display reads -1312.

Note: The output may be saturated before it reaches the minimum or maximum value.

This parameter is available when Output 1 is Current or Linear Voltage.



### Analog Low Adjustment

ID Number P1-18

The Analog Low Adjustment parameter is used to adjust the actual analog output value when the output is 0%. To set up this parameter, place the SOLO controller in the Manual control mode and set the Output 1 Level ( P2-11) to 0% then increase / decrease the parameter value to get the desired analog output value.

The tables below show the approximate Analog Low Adjustment values needed to obtain the desired output value. The actual controller output will vary. Check and adjust the values until the desired output level is achieved.

Current Output								
	0mA	1mA	2mA	3mA	4mA	5mA	6mA	7mA
	-1440	-1080	-720	-360	0	360	720	1080
	8mA	9mA	10mA	11mA	12mA	13mA	14mA	15mA
	1440	1799	2159	2519	2879	3239	3599	3959
	16mA	17mA	18mA	19mA	20mA			
	4319	4678	5038	5398	5758			

Voltage Output								
	0V	1V	2V	3V	4V	5V	6V	7V
<b>[rLo]</b>	0	759	1518	2277	3036	3795	4553	5312
	8V	9V	10V					
<b>[rLo]</b>	6071	6830	7589					



---

*Note: When increasing the parameter value of Analog Low Adjustment above 9999, the SOLO display will “roll up” to 0000, indicating a value of 10000. For example, to enter a value of 10625 for Analog Low Adjustment, hold the **▲** button until the SOLO display reads 0625.*

---



---

*Note: The output may be saturated before it reaches the minimum or maximum value.*

---

This parameter is available when Output 1 is Current or Linear Voltage.

## Operation Mode Parameters

Press the **↵** button to access these parameters.

**r-s****Run / Stop****ID Number P2-1**

The Run / Stop parameter is used to control the operational status of the SOLO Controller. The available range varies according to the control mode and the status of the EVENT 1 input. The Event 1 input is available only for the SL4896 and SL9696 series controllers.

PID, On / Off and Manual Control Modes		
	Run	Stop
Event 1 input is off. (Event 1 input is open.)	<b>rUn</b>	<b>ESTP</b>
Event 1 input is on. (Event 1 input is closed.)	N/A	<b>SToP,ESTP</b>

Ramp / Soak Control Mode			
	Run	Hold	Stop
Event 1 input is off. (Event 1 input is open.)	<b>rUn</b>	<b>PHod</b>	<b>ESTP,PSStP</b>
Event 1 input is on. (Event 1 input is closed.)	N/A	N/A	<b>SToP,ESTP</b>

**rUn**

Run mode

**ESTP**

Stop mode

**SToP**

Stop mode (The controller was in Stop mode when the Event 1 input was closed.)

**ESTP**

Stop mode (The controller was in Run mode when the Event 1 input was closed.)

**PHod**

Ramp / Soak control is on hold. The controller keeps the current Ramp / Soak step number and time. Ramp / Soak control continues when the mode is changed to Run.

**PSStP**

Ramp / Soak control is stopped. The controller restarts the Ramp / Soak control at the first step when the mode is changed to Run.

**PtErn****Starting Ramp / Soak Pattern****ID Number P2-2**

Range: 0 to 7

Select the Ramp / Soak pattern number to start the Ramp / Soak control.

**SP****Decimal Point Position****ID Number P2-3**

Range: 0 (\*\*\*\*)

1 (\*\*\*)

2 (\*\*)

3 (\* \*\*)

This parameter defines the decimal point position on the PV and SV display.

**AL 1H****Alarm 1 High Limit****ID Number P2-4**

This parameter is used to set the high limit for Alarm 1. The range varies according to other parameter values.

**AL 1L Alarm 1 Low Limit ID Number P2-5**

This parameter is used to set the low limit for Alarm 1. The range varies according to other parameter values.

**AL 2H Alarm 2 High Limit ID Number P2-6**

This parameter is used to set the high limit for Alarm 2. The range varies according to other parameter values.

**AL 2L Alarm 2 Low Limit ID Number P2-7**

This parameter is used to set the low limit for Alarm 2. The range varies according to other parameter values.

**AL 3H Alarm 3 High Limit ID Number P2-8**

This parameter is used to set the high limit for Alarm 3. The range varies according to other parameter values.

**AL 3L Alarm 3 Low Limit ID Number P2-9**

This parameter is used to set the low limit for Alarm 3. The range varies according to other parameter values.

**LoC Lock Mode ID Number P2-10**

Range: **OFF** The Lock feature is disabled.

**LoC1** Lock Mode 1

**LoC2** Lock Mode 2

Lock Mode 1: All key pad operation is ignored. Press the **SET** key and the key at the same time to cancel this lock mode.

Lock Mode 2: All key pad operation is ignored except changing the SV. Press the **SET** key and the key at the same time to cancel this lock mode.

**OUT 1 Output 1 Level ID Number P2-11**

Range: 0.0 to 100 (%)

The value for this parameter can be changed in the Manual control mode. In other control modes, this parameter is read-only.

**OUT 2 Output 2 Level ID Number P2-12**

Range: 0.0 to 100 (%)

This parameter is available when Output 2 is used. Refer to the Heating / Cooling parameter (**S-HC**, P3-7) to disable / enable Output 2. The value for this parameter can be changed in the Manual control mode. In other control modes, this parameter is read-only.

## Initial Setting Parameters

Press the **SET** button for more than three seconds to access these parameters.

**Input Type**

Input Type

ID Number P3-1

This parameter defines the input signal type.

Thermocouple* Type and Temperature Range		
Input Temperature Sensor Type	LED Display	Temperature Range
Thermocouple TXK type	<b>TXK</b>	-328 ~ 1472°F (-200 ~ 800°C)
Thermocouple U type	<b>U</b>	-328 ~ 932°F (-200 ~ 500°C)
Thermocouple L type	<b>L</b>	-328 ~ 1562°F (-200 ~ 850°C)
Thermocouple B type	<b>B</b>	212 ~ 3272°F (100 ~ 1800°C)
Thermocouple S type	<b>S</b>	32 ~ 3092°F (0 ~ 1700°C)
Thermocouple R type	<b>R</b>	32 ~ 3092°F (0 ~ 1700°C)
Thermocouple N type	<b>N</b>	-328 ~ 2372°F (-200 ~ 1300°C)
Thermocouple E type	<b>E</b>	32 ~ 1112°F (0 ~ 600°C)
Thermocouple T type	<b>T</b>	-328 ~ 752°F (-200 ~ 400°C)
Thermocouple J type	<b>J</b>	-148 ~ 2192°F (-100 ~ 1200°C)
Thermocouple K type	<b>K</b>	-328 ~ 2372°F (-200 ~ 1300°C)
RTD Type and Temperature Range		
Input Temperature Sensor Type	LED Display	Temperature Range
Platinum Resistance (Pt100)	<b>PT</b>	-328 ~ 1112°F (-200 ~ 600°C)
Platinum Resistance (JPT100)	<b>JPT</b>	-4 ~ 752°F (-20 ~ 400°C)
Voltage Input Type and Input Range		
Voltage Input Type	LED Display	Temperature Range
0~50mV Analog Input	<b>0.5</b>	-999 ~ 9999
0V~10V Analog Input	<b>0.10</b>	-999 ~ 9999
0V~5V Analog Input	<b>0.5</b>	-999 ~ 9999
Current Input Type and Input Range		
Current Input Type	LED Display	Temperature Range
4~20mA Analog Input	<b>0.04</b>	-999 ~ 9999
0~20mA Analog Input	<b>0.00</b>	-999 ~ 9999

*\*Note - Use only ungrounded thermocouples*

**Temperature Unit**

Temperature Unit

ID Number P3-2

Range: F, C

This parameter is available when the parameter Input Type is a thermocouple or RTD.

**EP-H**

### Input Range High

ID Number P3-3

Range: From the value of Input Range Low to 9999.

This parameter defines the high limit of the PV. This is the maximum value of the operational temperature range. In operation, if the PV value is higher than the **EP-H** value, th PV flashes to indicate an error and the controller outputs shut off. The SV value cannot exceed the **EP-H** value. This parameter cannot be lower than the Input Range Low parameter (**EP-L**, P3-4).

**EP-L**

### Input Range Low

ID Number P3-4

Range: From -999 to the value of Input Range High.

This parameter defines the low limit of the PV. This is the minimum value of the operational temperature range. In operation, if the PV value is lower than the **EP-L** value, th PV flashes to indicate an error and the controller outputs shut off. The SV value cannot be set lower than the **EP-L** value. This parameter cannot be higher than the Input Range High parameter (**EP-H**, P3-3).

**CTRL**

### Control Mode

ID Number P3-5

Range: **PID** PID control mode  
**OnOff** On / Off control mode  
**MANU** Manual control mode  
**Ramp** Ramp / Soak control mode

This parameter is used to select one of the control modes. See Chapter 5 for a complete discription of each control mode.

**PATn**

### Ramp / Soak Pattern

ID Number P3-6

Range: oFF Ramp / Soak pattern is not selected.  
0 to 7 Ramp / Soak pattern number.

This parameter is used to select the appropriate Ramp / Soak pattern number for setting up it's individual parameters. Once a Ramp / Soak pattern number (0-7) is selected, the controller only displays the following pattern setup parameters until the **SET** key is pressed.

	Ramp / Soak Pattern Number							
	0	1	2	3	4	5	6	7
Step 0 SV	SP00	SP10	SP20	SP30	SP40	SP50	SP60	SP70
Step 0 Time	ET00	ET10	ET20	ET30	ET40	ET50	ET60	ET70
Step 1 SV	SP01	SP11	SP21	SP31	SP41	SP51	SP61	SP71
Step 1 Time	ET01	ET11	ET21	ET31	ET41	ET51	ET61	ET71
Step 2 SV	SP02	SP12	SP22	SP32	SP42	SP52	SP62	SP72
Step 2 Time	ET02	ET12	ET22	ET32	ET42	ET52	ET62	ET72
Step 3 SV	SP03	SP13	SP23	SP33	SP43	SP53	SP63	SP73
Step 3 Time	ET03	ET13	ET23	ET33	ET43	ET53	ET63	ET73
Step 4 SV	SP04	SP14	SP24	SP34	SP44	SP54	SP64	SP74
Step 4 Time	ET04	ET14	ET24	ET34	ET44	ET54	ET64	ET74
Step 5 SV	SP05	SP15	SP25	SP35	SP45	SP55	SP65	SP75
Step 5 Time	ET05	ET15	ET25	ET35	ET45	ET55	ET65	ET75
Step 6 SV	SP06	SP16	SP26	SP36	SP46	SP56	SP66	SP76
Step 6 Time	ET06	ET16	ET26	ET36	ET46	ET56	ET66	ET76
Step 7 SV	SP07	SP17	SP27	SP37	SP47	SP57	SP67	SP77
Step 7 Time	ET07	ET17	ET27	ET37	ET47	ET57	ET67	ET77
Last Step Number	SP40	SP41	SP42	SP43	SP44	SP45	SP46	SP47
Additional Cycles	CYC0	CYC1	CYC2	CYC3	CYC4	CYC5	CYC6	CYC7
Next Pattern Number	LN0	LN1	LN2	LN3	LN4	LN5	LN6	LN7

Below is an example of a typical Ramp / Soak Pattern.

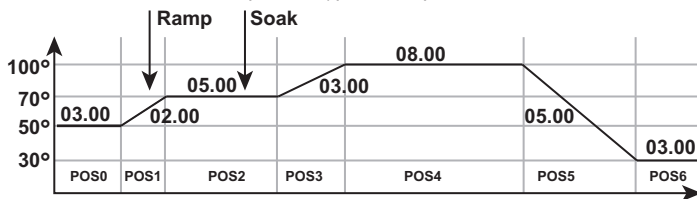

SP00	Step00 = 50°	SP03	Step03 = 100°	SP06	Step06 = 30°
ET00	Time00 = 3 hrs 00 min.	ET03	Time03 = 3 hrs 00 min.	ET06	Time06 = 3 hrs 00 min.
SP01	Step01 = 70°	SP04	Step04 = 100°	PS40	Process Step = 6
ET01	Time01 = 2 hrs 00 min.	ET04	Time04 = 8 hrs 00 min.	CYC0	Cycle times = 0
SP02	Step02 = 70°	SP05	Step05 = 30°	LN0	Link = OFF
ET02	Time02 = 5 hrs 00 min.	ET05	Time05 = 5 hrs 00 min.		

**S-HC**

**Heating / Cooling**

**ID Number P3-7**



Range: **HEAT** Output 1 = Heating, Output 2 = Unused

**COOL** Output 1 = Cooling, Output 2 = Unused

**H/ILC** Output 1 = Heating, Output 2 = Cooling

**H/EC** Output 1 = Cooling, Output 2 = Heating

The Heating / Cooling parameter defines whether one or two outputs will be controlled and what type of control they will perform.



---

*Note: Unused Output 2 can be used as an Alarm.*

---

<b>ALARM1</b>	Alarm 1	ID Number P3-8
<b>ALARM2</b>	Alarm 2	ID Number P3-9
<b>ALARM3</b>	Alarm 3	ID Number P3-10

Range: 0 to 18

The SOLO controllers support 3 alarm outputs. (The SL4824 series supports only one alarm output.) The Alarm1, Alarm2 and Alarm3 parameters are used to select the alarm type. Refer to Chapter 4 for details.

<b>SALA</b>	System Alarm	ID Number P3-11
-------------	--------------	-----------------

Range: **OFF** System Alarm feature is disabled

**ALARM1** Alarm 1

**ALARM2** Alarm 2

**ALARM3** Alarm 3

This parameter defines which Alarm output is used for the system alarm. The System Alarm parameter defines an alarm output if there is an input error or process control failure. Refer to Chapter 4 for complete details.

### Initial Setting Communication Parameters

<b>COASH</b>	On-Line Configuration	ID Number P3-12
--------------	-----------------------	-----------------

Range: **OFF** Do not allow changes to the parameters through the RS-485 port.

**ON**

Allow changes to the parameters through the RS-485 port.

<b>CSL</b>	Modbus Protocol	ID Number P3-13
------------	-----------------	-----------------

Range: **ASCII** Modbus ASCII

**RTU** Modbus RTU

<b>CNO</b>	Network Address	ID Number P3-14
------------	-----------------	-----------------

Range: 1 to 247

This is the Modbus network address of the SOLO Controller.



---

*Note: Each controller on the same network must have a unique Modbus network address*

---

**bPS**      **Baud Rate**      **ID Number P3-15**

Range: **2400** 2400 bps  
**4800** 4800 bps  
**9600** 9600 bps  
**1920** 19200 bps  
**3840** 38400 bps

**LEn**      **Bit Length**      **ID Number P3-16**

Range: 7, 8

**Prty**      **Parity**      **ID Number P3-17**

Range: None, Even, Odd

**Stop**      **Stop Bit**      **ID Number P3-18**

Range: 1, 2

**Initial Setting Ramp / Soak Parameters****SP<sub>mn</sub>**      **Ramp / Soak SV**      **ID Number P3-19**

Range: -99.9 to 999.9

This parameter is the set point value (SV) of each Ramp / Soak step.

This parameter can be displayed as **SP00** to **SP77**. The third character indicates the Ramp / Soak pattern number (*m*) and the last digit indicates the step number (*n*).

e.g. **SP35** = SV set point value of Step 5 of the Ramp / Soak pattern 3.

**ET<sub>mn</sub>**      **Ramp / Soak Time**      **ID Number P3-20**

Range: 00.00 to 15.00 (0 to 15 hours) [Format: hours.minutes]

This parameter is the time duration of each Ramp / Soak step.

This parameter can be displayed as **ET00** to **ET77**. The third character indicates the Ramp / Soak pattern number (*m*) and the last digit indicates the step number (*n*).

e.g. **ET35** = SV set point value of Step 5 of the Ramp / Soak pattern 3.

**PSE<sub>n</sub>**      **Last Step Number**      **ID Number P3-21**

Range: 0 to 7

Each Ramp / Soak pattern can have up to seven steps. This parameter is the last step number that is to be used in the Ramp / Soak pattern. When the parameter value is set to 0, the SOLO controller executes only step 0 when the Ramp / Soak pattern is selected. When the value is 7, the controller executes step 0 through step 7 when the Ramp / Soak pattern is selected.

**Additional Cycles****ID Number P3-22**

Range: 0 to 199

As the default, the SOLO controller executes a Ramp / Soak pattern only once. Use this parameter to set the number of additional times a Ramp / Soak pattern will execute. When the parameter value is set to 0, the SOLO controller executes the Ramp / Soak pattern one time. When this parameter value is 2, the Ramp / Soak pattern will execute two additional times for a total of three executions.

**Next Pattern Number****ID Number P3-22**

Range: 0 to 7, OFF

This parameter is used to select a Ramp / Soak pattern that will execute after the current Ramp / Soak pattern is completed. If the parameter value is set to OFF, the SOLO controller will not begin another Ramp / Soak pattern after the current pattern.

## Reset to Factory Default



*Note: Resetting the Temperature Controller back to factory default erases all of the values entered by the user. Record any necessary settings before proceeding*



**Warning: Erasing the user entered values may result in a safety hazard and system malfunction.**

The following instructions reset the controller to the factory default.

- 1 Press the button until the parameter **L o L** appears. Use the button to select **L o L 1**. Press the **SET** button.
- 2 Press and hold the and buttons simultaneously for one second and release.
- 3 Press the button until the PV display shows **PASS**. Use the button to change the value on the SV display to **135 7**. Press the **SET** button.
- 4 Cycle power on the Controller to reset to factory default mode. All user set values are erased.

**CONTROLLER  
INPUTS AND  
OUTPUTS**

---



**In this Chapter...**

**Control Input Types.....4-2**

**Event Inputs .....4-3**

**Control Output Types.....4-4**

**Alarm Outputs .....4-8**

## Control Input Types

### Thermocouple or RTD Input

The SOLO temperature controller can accept input from eleven types of thermocouples and two types of Platinum RTD sensors. Select the sensor type by using the parameter Input Type (**INPT**, P3-1).

Thermocouple* Type and Temperature Range		
Input Temperature Sensor Type	LED Display	Temperature Range
Thermocouple TXK type		-328 ~ 1472°F (-200 ~ 800°C)
Thermocouple U type		-328 ~ 932°F (-200 ~ 500°C)
Thermocouple L type		-328 ~ 1562°F (-200 ~ 850°C)
Thermocouple B type		212 ~ 3272°F (100 ~ 1800°C)
Thermocouple S type		32 ~ 3092°F (0 ~ 1700°C)
Thermocouple R type		32 ~ 3092°F (0 ~ 1700°C)
Thermocouple N type		-328 ~ 2372°F (-200 ~ 1300°C)
Thermocouple E type		32 ~ 1112°F (0 ~ 600°C)
Thermocouple T type		-328 ~ 752°F (-200 ~ 400°C)
Thermocouple J type		-148 ~ 2192°F (-100 ~ 1200°C)
Thermocouple K type		-328 ~ 2372°F (-200 ~ 1300°C)
RTD Type and Temperature Range		
Input Temperature Sensor Type	LED Display	Temperature Range
Platinum Resistance (Pt100)		-328 ~ 1112°F (-200 ~ 600°C)
Platinum Resistance (JPt100)		-4 ~ 752°F (-20 ~ 400°C)

*\*Note - Use only ungrounded thermocouples*

### Analog Input

The SOLO temperature controller can accept input from the following analog input sources. Select the output type by using the parameter Input Type (**INPT**, P3-1).

Voltage Input Type and Input Range		
Voltage Input Type	LED Display	Temperature Range
0~50mV Analog Input		-999 ~ 9999
0V~10V Analog Input		-999 ~ 9999
0V~5V Analog Input		-999 ~ 9999
Current Input Type and Input Range*		
Current Input Type	LED Display	Temperature Range
4~20mA Analog Input		-999 ~ 9999
0~20mA Analog Input		-999 ~ 9999

*\*Note: For Current Input operation, the supplied 249 Ω resistor should be installed as shown on page 4-3.*



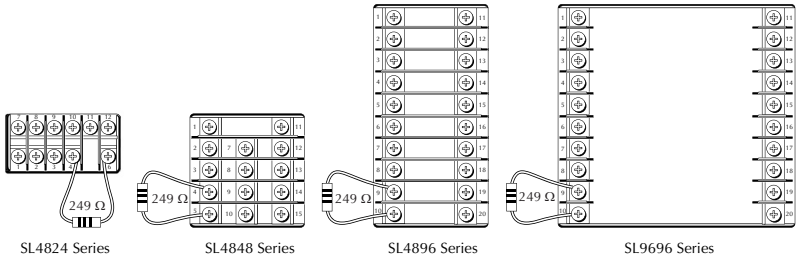

## Event Inputs

The SL4896 and SL9696 series SOLO controllers support two Event inputs, Event 1 and Event 2. When an Event input is not connected to anything (open), the status of the Event input is off. When the Event input terminal is connected to the signal ground terminal (SG), the status of the Event input is on.

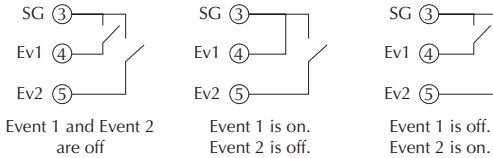

Event 1 and Event 2 have different functions.

### Event 1 Input

Once the Event 1 input is turned on, both control outputs OUT1 and OUT2 are turned off. This does not effect the status of the alarm outputs. If an alarm output is on when the Event 1 input is turned on, the alarm output remains on as long as the condition of the alarm is true.

This Event 1 input can be used to shut down the control outputs quickly with an external input like a pushbutton or sensor.

### Event 2 Input

All SOLO controllers support four PID parameter groups. The SL4896 and SL9696 series SOLO controllers support an additional PID parameter group. When the Event 2 input is on, the SOLO controller uses the additional PID parameter group.

SL4824 / SL4848
PID Parameter group 0
PID Parameter group 1
PID Parameter group 2
PID Parameter group 3

SL4896 / SL9696
PID Parameter group 0
PID Parameter group 1
PID Parameter group 2
PID Parameter group 3
PID Parameter group (Event 2 is on)



*Note: The additional PID parameter group can be accessed only when the Event 2 input is on. To edit the PID Parameter group for Event 2 input, Event 2 input must be on.*

The Event 2 input can be used to force the Process Value (PV) to reach the predefined Set Value (SV) when an external input is turned on, but still using the PID control.

## Control Output Types

The SOLO temperature controller supports four types of control outputs depending on the model chosen. The available outputs are Relay, Voltage Pulse, Current and Linear Voltage as shown in the controller part number.

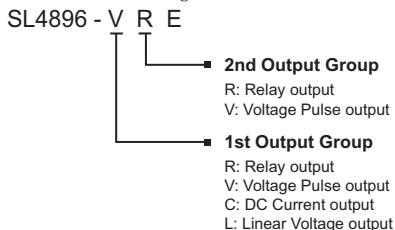

### Relay Output

The relay used for the relay output in model SL4824 is rated at a maximum 250 VAC and 3A resistive load. The relay used for the relay output in models SL4848, SL4896 and SL9696 is rated at a maximum 250 VAC and 5A resistive load. The electrical life expectancy is 100,000 operations.

The operation cycle of the Relay output is controlled by two factors, Output Level and Output Period.

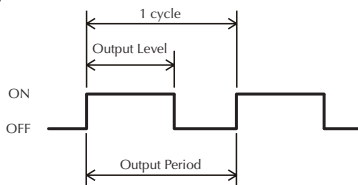

For example, when the Output Level is 60% and the Output Period is 10 seconds, the output relay is turned on for 6 seconds in the cycle.

There are five parameters that define these two factors.

### Output Level

Output 1 Level (**OUT1**, P2-11) Range: 0.0 to 100%

Output 2 Level (**OUT2**, P2-12) Range: 0.0 to 100%

### Output Period

Output 1 Heating Period (**HEPd**, P1-11) Range: 0.5 to 99 seconds

Output 1 Cooling Period (**CLPd**, P1-12) Range: 0.5 to 99 seconds

Output 2 Period (**HEPd**, P1-13) Range: 0.5 to 99 seconds



*Note: The electrical life expectancy of the relay output is 100,000 cycles. To maximize the life of the relay output, set a longer time value for the Output Period.*

### Voltage Pulse Output

The Voltage Pulse output generates 40 mA pulses. The pulse high level is 14 VDC and the low level is 0VDC.

The operation cycle of the Voltage Pulse output is controlled by two factors, Output Level and Output Period.

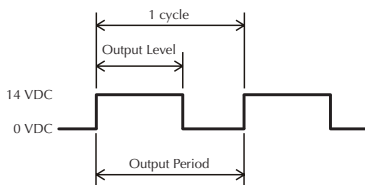

For example, when the Output Level is 60% and the Output Period is 10 seconds, the Voltage Pulse output is turned on for 6 seconds in the cycle.

There are five parameters that define these two factors.

### Output Level

Output 1 Level (**OUTL1**, P2-11) Range: 0.0 to 100%

Output 2 Level (**OUTL2**, P2-12) Range: 0.0 to 100%

### Output Period

Output 1 Heating Period (**HEPd**, P1-11) Range: 0.5 to 99 seconds

Output 1 Cooling Period (**CLPd**, P1-12) Range: 0.5 to 99 seconds

Output 2 Period (**HEPd**, P1-13) Range: 0.5 to 99 seconds

### Current Output

The Current output generates analog DC current with a range of 4-20 mA. The maximum load resistance is 600  $\Omega$

The output current is controlled by four factors, Analog High Adjustment, Analog Low Adjustment, Output Level and Output Period.



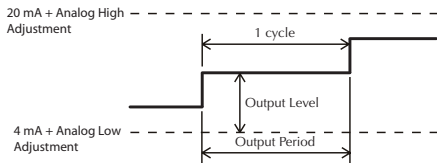

The Analog High Adjustment value may be changed to adjust the output current when the Output Level is 100%. The adjustment needs to be done in the Manual mode.

The Analog Low Adjustment value may be changed to adjust the output current when the Output Level is 0%. The adjustment also needs to be done in the Manual mode.

The Output Level determines the output current level between “20mA + Analog High Adjustment” and “4mA + Analog Low Adjustment”. The output current will be 10 mA in the following example.

$$\begin{aligned}20\text{mA} + \text{Analog High Adjustment} &= 18\text{mA} \\4\text{mA} + \text{Analog Low Adjustment} &= 2\text{mA} \\ \text{Output Level} = 50\% &\end{aligned}$$

The Output Period sets how often the SOLO controller updates the output value.

There are five parameters that define these four factors.

### Analog High Adjustment

Analog High Adjustment (**CRHL**, P1-17)

### Analog Low Adjustment

Analog Low Adjustment (**CRLO**, P1-18)

### Output Level

Output 1 Level (**OUTL**, P2-11) Range: 0.0 to 100%

### Output Period

Output 1 Heating Period (**HEPd**, P1-11) Range: 0.5 to 99 seconds

Output 1 Cooling Period (**CLPd**, P1-12) Range: 0.5 to 99 seconds

## Linear Voltage Output

The Linear Voltage output generates analog voltage from 0-10 VDC. The minimum load resistance is 1k $\Omega$ .

The output voltage is controlled by four factors, Analog High Adjustment, Analog Low Adjustment, Output Level and Output Period.

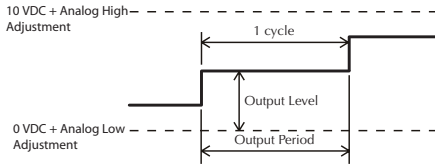

The Analog High Adjustment value may be changed to adjust the output voltage when the Output Level is 100%. The adjustment needs to be done in the Manual mode.

The Analog Low Adjustment value may be changed to adjust the output voltage when the Output Level is 0%. The adjustment needs to be done in the Manual mode.

The Output Level determines the output voltage level between “10 VDC + Analog High Adjustment” and “0VDC + Analog Low Adjustment”. The output voltage will be 4 VDC in the following example.

$$\begin{aligned} 10 \text{ VDC} + \text{Analog High Adjustment} &= 7\text{VDC} \\ 0\text{VDC} + \text{Analog Low Adjustment} &= 1\text{VDC} \\ \text{Output Level} = 50\% \end{aligned}$$

The Output Period sets how often the SOLO controller updates the output value.

There are five parameters that define these two factors.

### Analog High Adjustment

Analog High Adjustment (**CrHa**, P1-17)

### Analog Low Adjustment

Analog Low Adjustment (**CrLo**, P1-18)

### Output Level

Output 1 Level (**OUT1**, P2-11) Range: 0.0 to 100%

### Output Period

Output 1 Heating Period (**HLPd**, P1-11) Range: 0.5 to 99 seconds

Output 1 Cooling Period (**CLPd**, P1-12) Range: 0.5 to 99 seconds

### Alarm Outputs

The SL4848, SL4896 and SL9696 series SOLO controllers support three alarm output groups (ALA1, ALA2, ALA3) and one system alarm output (SALA). The SL4824 series SOLO controller supports one alarm output group (ALA1) and one system alarm output (SALA). ALA1 and ALA2 are both SPST normally open relay outputs. ALA3 uses the same output as Output 2 and is the same type of output.



---

*Note: The system alarm does not have a dedicated output that can be used only for the system alarm. One of the alarm outputs can be used for the system alarm. See page 4-11.*

---



---

*Note: When Output 2 is used, ALA3 is disabled. ALA3 is available only when single output control is selected.*

---

**See the Alarm Output Chart on the following page.**

## Alarm Output Types

Set Value	Alarm Type	Alarm Output Operation
0	Alarm function disabled	Output is OFF
1	Deviation upper and lower limit: This alarm output activates when the PV value is higher than the setting value SV + ALnH or lower than the setting value SV - ALnL.	
2	Deviation upper-limit: This alarm output activates when the PV value is higher than the setting value SV + ALnH.	
3	Deviation lower limit: This alarm output activates when the PV value is lower than the setting value SV - ALnL.	
4	Reverse deviation upper and lower limit: This alarm output activates when the PV value is in the range of the setting value SV+ ALnH and the setting value SV - ALnL.	
5	Absolute value upper and lower limit: This alarm output activates when the PV value is higher than the setting value ALnH or lower than the setting value ALnL.	
6	Absolute value upper-limit: This alarm output activates when the PV value is higher than the setting value ALnH	
7	Absolute value lower limit: This alarm output activates when the PV value is lower than the setting value ALnL.	
8	Deviation upper and lower limit with standby sequence: After the PV reaches the SV once, this alarm output activates when the PV value reaches the set point (SV value) and the reached value is higher than the setting value SV + ALnH or lower than the setting value SV - ALnL.	
9	Deviation upper limit with standby sequence: After the PV reaches the SV once, this alarm output activates when the PV value reaches the set point (SV value) and the reached value is higher than the setting value SV+ ALnH.	
10	Deviation lower limit with standby sequence: After the PV reaches the SV once, this alarm output activates when the PV value reaches the set point (SV value) and the reached value is lower than the setting value SV - ALnL.	
11	Hysteresis upper-limit alarm output: This alarm output activates when the PV value is higher than the setting value SV + ALnH. This alarm output is OFF when the PV value is lower than the setting value SV + ALnL.	
12	Hysteresis lower-limit alarm output: This alarm output activates when the PV value is lower than the setting value SV - ALnH. This alarm output is OFF when the PV value is higher than the setting value SV - ALnL.	
13	N/A	
Ramp / Soak Program Alarms		
14	This alarm activates when the Ramp / Soak program has ended.	
15	This alarm activates while the program is in RAMP UP status.	
16	This alarm activates while the program is in RAMP DOWN status.	
17	This alarm activates while the program is in SOAK status.	
18	This alarm activates while the program is in RUN status.	



Note: ALnH includes AL1H, AL2H and AL3H. ALnL includes AL1L, AL2L and AL3L.

### System Alarm Output

The system alarm can be used to indicate the following system error.

**System Error:** The SOLO controller checks the control outputs for correct operation by monitoring the PV value. If the heating output is on but the PV keeps dropping for two minutes, the system alarm turns on. Or, if the cooling output is on but the PV continues to increase for two minutes, the system alarm



---

*Note: The SOLO controller checks the PV every 15 seconds. If the PV continues increasing / decreasing eight times when the controller checks the PV, the system alarm turns on. (15 seconds x 8 = 2 minutes). If the PV does not increase / decrease when the controller checks it, the controller resets the counter. The PV would have to increase / decrease for an additional two minutes to activate the alarm.*

---

turns on.

On series SL4848, SL4896 and SL9696 controllers, the system alarm can be assigned to one of the alarm outputs 1 - 3. Series SL4824 supports only one alarm output. Use the System Alarm Parameter (**SLA**, P3-11) to set the alarm output number. The system alarm can be disabled by setting the System Alarm (**SLA**, P3-11) to OFF.

When the system alarm output is on, the corresponding Alarm Output is on and the PV display on the controller starts flashing.



# CONTROL MODES

---



# CHAPTER

# 5

## In this Chapter...

PID Control .....	5-2
On / Off Control .....	5-3
Ramp / Soak Control .....	5-4
Manual Control .....	5-5
Error Display Information .....	5-5

The SOLO controller can be configured for any of the following control modes.

- PID control
- On / Off control
- Ramp / Soak control
- Manual control

## PID Control

All of the SOLO controllers can store up to four PID parameter groups (PID parameter groups 0 - 3)

	Group 0	Group 1	Group 2	Group 3
Set Value	SV0	SV1	SV2	SV3
Proportion Band	P0	P1	P2	P3
Integral Time	I0	I1	I2	I3
Derivative Time	D0	D1	D2	D3
Integral Offset	IOF0	IOF1	IOF2	IOF3



*Note: Other parameters are shared among all PID parameter groups.*

The operator can select any of the parameter groups for PID control. The SOLO controller also supports the PID parameter group 4. However, this is not an actual parameter group. When the PID parameter group 4 is selected, the controller checks the SV of each parameter group and uses the parameter group which has a SV that is the closest to the SV set by the operator. If there are two or more PID parameter groups that have SV values equally close to the SV, the controller uses the lowest number parameter group (eg. If parameter groups 0 - 3 have the same SV, the controller uses the parameter group 0).

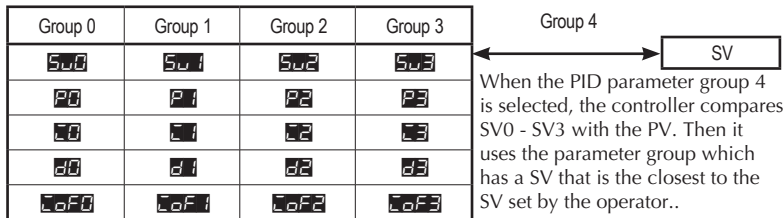

Once the controller selects one of the PID parameter groups (group 0 - 3), the setup parameters of the selected parameter group are displayed on the controller.

The SL4896 and SL9696 series controller also support an additional PID parameter group. The parameter group is used with the Event2 input. When Event2 input is on, the SOLO controller uses the additional PID group for the PID control.

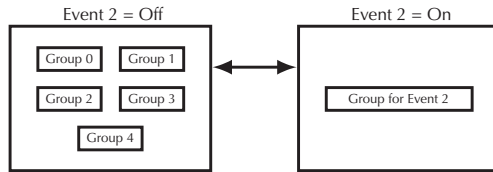

## Auto Tuning

All SOLO controllers support the Auto Tuning feature to set up the following PID parameters automatically.

- P** Proportional Band (**Pn**, P1-4)
- I** Integral Time (**In**, P1-5)
- d** Derivative Time (**dn**, P1-6)
- COF** Integral Offset (**COFn**, P1-8)
- COEF** Proportional Band Coefficient (**COEFn**, P1-14)

To start the Auto Tuning, set the parameter Auto Tuning (**AT**, P1-1) to on. the controller automatically controls the output to change the PV as shown below.

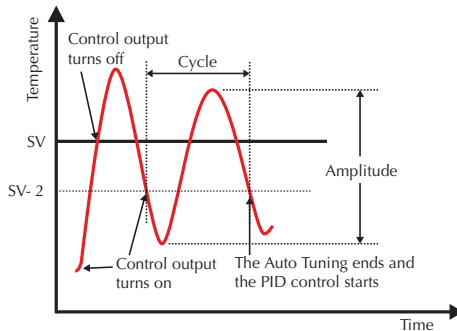

Once the Auto Tuning process is completed, the SOLO controller calculates the above PID parameters and starts the PID control with the new parameter values immediately.

## On / Off Control

In the On / Off control mode the output is controlled according to the difference between the SV and the PV. If the PV is lower than the SV, the heating output is turned on. If the PV is higher than the SV, the cooling output is turned on. The Heating / Cooling Hysteresis and the Dead Band setups can be used to avoid output chatter.



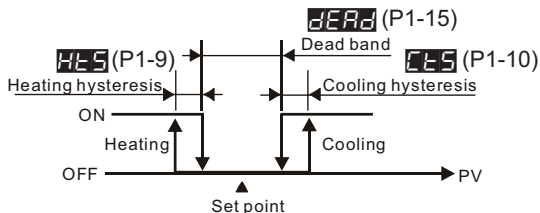

## Hysteresis

There are two types of hysteresis, heating and cooling. If the heating hysteresis is set, the heating output turns on using the following formula.

$$PV < SV - (DEAD / 2) - HLS$$

If the cooling hysteresis is set, the cooling output turns on using the following formula.

$$PV > SV + (DEAD / 2) + CLS$$

## Dead Band

The Dead Band is the range around the PV in which the heating / cooling outputs remain off. The Dead Band is defined by the formula.

$$SV \pm (DEAD / 2)$$

## Ramp / Soak Control

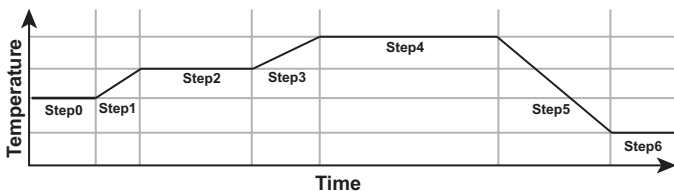

The Ramp / Soak control mode is used to control the outputs according to the preprogrammed SV patterns with the PID control method. The SOLO controllers support up to eight Ramp / Soak patterns. Each Ramp / Soak pattern can store up to eight steps. Each step has its target SV and the time duration setups. You can set up each Ramp / Soak step.



You can select which Ramp / Soak pattern the SOLO controller will execute first. The Ramp / Soak patterns can be executed in series, so the Ramp / Soak control can execute up to 64 steps (8 steps x 8 patterns). You can select which Ramp / Soak pattern will execute next or the controller stops after executing the current pattern.

The SOLO controller can execute the same Ramp / Soak pattern up to 200 times before it stops or moves to the next Ramp / Soak pattern.

### Ramp / Soak Display

There are three Ramp / Soak display modes possible with the SOLO controller. From the controller main screen press the  and  buttons to choose from these three optional display modes.



 - Pattern Number - Step Number

 - Set Point

 - Remaining time in current step











Press the  button to save the selection.

## Manual Control

In the Manual control mode, the outputs of the controller are manipulated manually by the operator. Adjust the values of the parameters Output 1 Level (, P2-11) and / or Output 2 Level (, P2-12) to control the output levels. Output 2 Level is only available when you select a dual output mode.

## Error Display Information

The chart below illustrates the possible error displays shown on the SOLO Temperature controller.

Controller Error Display				
Display Position	Display	Meaning	Cause	Corrective Action
PV		Initialization PV = Firmware version SV = Module type	The controller is in the initialization process.	The SOLO controller displays this information for a few seconds after power up. If the controller continues displaying this information, check the input wiring. If the problem still exists, replace the sensor or the controller.
SV				
PV		No sensor input	The input terminals are open.	Check the input wiring. If the problem still exists, replace the sensor or the controller.
SV				
PV		Input error	The controller cannot read the input value	Check the sensor and the input wiring. If the problem still exists, replace the sensor or the controller.
SV				
PV		EEPROM error	There is an error with the EEPROM	Cycle the power to the SOLO controller. If the problem still exists, replace the controller.
SV				
PV	Flashing PV	PV out of range	The PV is out of range	Check the PV range. The Input Range High (  , P3-3) and the Input Range Low (  , P3-4) parameters define the range. Refer to section 12-1, 12-2 or 12-3 for directions on how to access these parameters.
SV				

# CONFIGURATION SOFTWARE

---



# CHAPTER 6

## In this Chapter...

PC Connection .....	6-2
Software Installation .....	6-3
Starting SL-SOFT.....	6-6
SL-SOFT Online Help .....	6-6

## PC Connection

To connect a PC to the SOLO controller, you will need the following component from AutomationDirect.

- SL-SOFT Configuration and Monitoring software
- USB-485M (USB to RS-485 communication adapter)

Use the supplied black 2-wire cable to connect the USB adapter to the SOLO controller. Plug the adapter into one of the PC's USB ports.

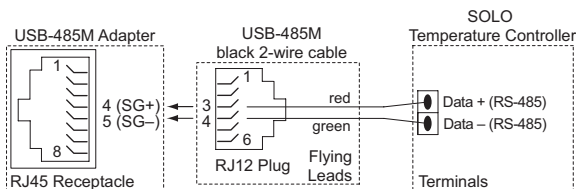

## Software Installation

To download the SL-SOFT software:

1. From the **AutomationDirect** software download page (<http://support.automationdirect.com/demos.html>), scroll down to **SOLO Temperature Controllers** and click the link.
2. Download **slsoft.exe** from the above URL and copy the content onto your computer at the location you prefer.
3. Unzip the installation file to a known location.
4. Double-click on **SL-SOFT Install.exe**.
5. Follow the on-screen instructions to complete the installation.

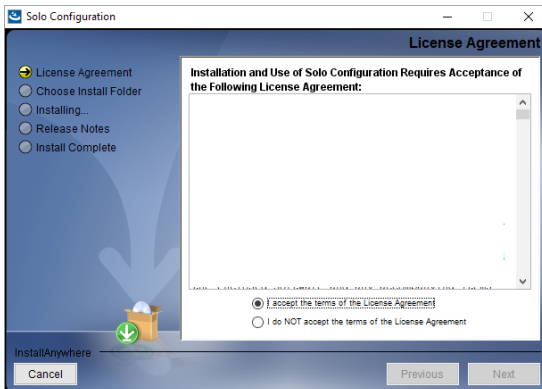
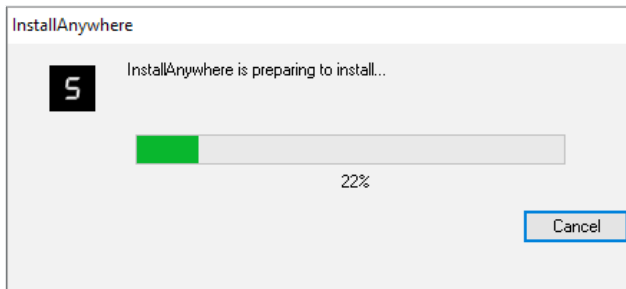

6. Read the **License Agreement**, and if you agree to the terms, click **Next**.

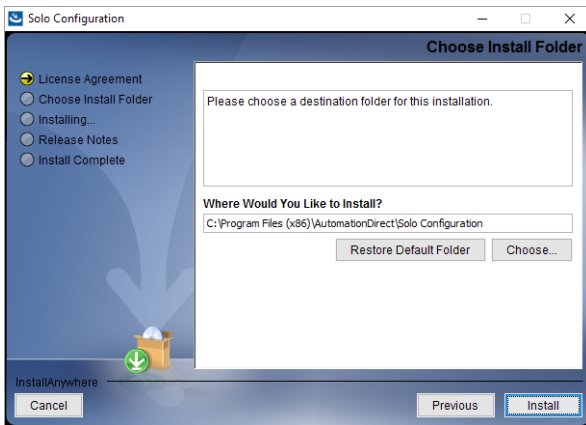

7. You may use either the default location or choose a different location by clicking **Choose** and browsing to the location. Then click **Install**.

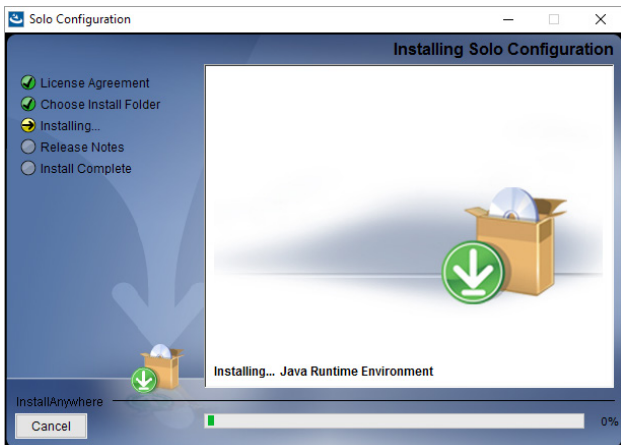

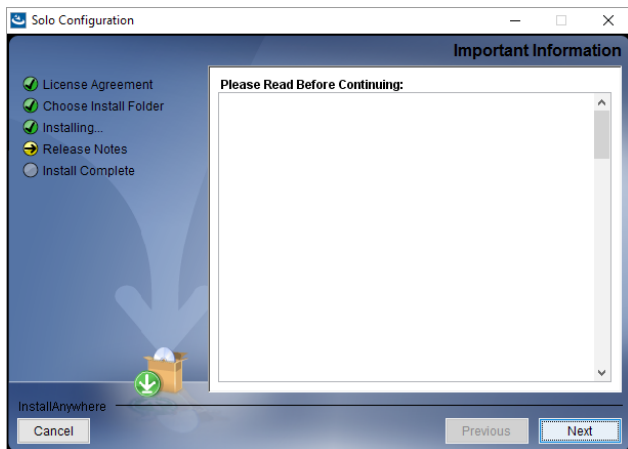

8. Read the **Release Note**, then click **Next**.

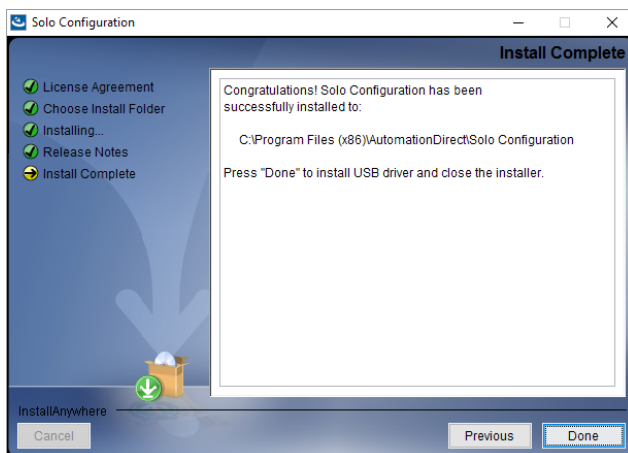

The installation of SL-SOFT is now complete. Although not required, it is recommended to use the AutomationDirect USB-485M Modbus adapter to communicate with the SOLO Temperature Controllers.

The driver for the USB-485M Modbus adapter can be found on AutomationDirect's website at <http://support.automationdirect.com/downloads.html>. If a different Modbus communication device is used, please ensure the drivers are installed prior to using SL-SOFT for the first time.

### Starting SL-SOFT

After installing the SL-SOFT software, click on the SL-SOFT icon to start using the software.



SL-SOFT allows multiple instances to run simultaneously, but care should be taken in selecting which communication ports are used because each instance must connect to its own communication port. No communication port sharing is allowed.

### SL-SOFT Online Help

After starting the SL-SOFT software, click the Help button for the following:

- Downloading the USB-485M adapter driver software
- Connecting the USB-485M adapter to your PC
- Navigating the SL-SOFT interface
- Setting up communications with the SOLO Temperature Controller
- Connecting the SOLO Temperature Controller to your PC
- Configuring the SOLO Temperature Controller
- Reading and writing values to and from the SOLO Temperature Controller
- Using real time and historical graphs to monitor trends
- Displaying the status of the connected SOLO Temperature Controller
- Linking to resources such as the *SOLO Temperature Controller Hardware Manual* and *Quick Start Guides*



# MODBUS COMMUNICATION

---



# CHAPTER 7

## In this Chapter...

Modbus Protocol .....	7-2
Registers.....	7-2
Connection with the DirectLOGIC PLC.....	7-8
Connection with the <i>C-more</i> and <i>C-more</i> Micro HMI panels...	7-10

## Modbus Protocol

All of the SOLO controllers have a 2-wire RS-485 serial communication port. The supported protocols are Modbus RTU and Modbus ASCII. The following communication port settings are possible.

	Protocol	
	Modbus RTU	<i>Modbus ASCII</i>
Network Address	1 to 247	
Baud Rate	2400, 4800, <b>9600</b> , 19200, 38400 bps	
Bit Length	8 bits	7, 8 bits
Parity	None, <b>Even</b> , Odd	
Stop Bit	1, 2 bits	



***Bold Italic*** text above represent default values in the SOLO controller.

## Registers

The SOLO controllers support two types of registers that are accessible through the Modbus communication.

- Data Registers
- Bit Registers

These registers support the following Modbus function codes.

### Data Registers

03: Read Holding Registers (maximum limit is read of eight registers)

06: Write Single Register

16: Write Multiple Registers (maximum limit is eight)

### Bit Registers

01: Read Coils

02: Read Discrete Inputs (Both Function Code 1 & 2 read the same memory area.)

05: Write Single Coil (Write FF00H to set the coil or 0000H to reset the coil.)

The following tables show all the Modbus addresses that are accessible through the Modbus network. For the details of each parameter, please refer to Chapter 3.



*Note: Make sure the On-Line Configuration parameter (**CO5H**, P3-12) is set to ON. The parameters in the SOLO controllers can be changed by the MODBUS network master only when the parameter is ON. (It is OFF as the factory default.)*

Data Registers						
ID	Parameter Name	Description	R/W	Hexadecimal	Modbus Decimal	PLC Address (Octal)
N/A	Process Value (PV)	If this register has one of the following values, it means there is an error:  8002H = Initial process (Temperature value is not yet available.) 8003H - Temperature sensor is not connected. 8004H = Temperature sensor input error 8006H = Cannot get temperature value, ADC input error 8007H Memory read / write error	R	1000	44097	V10000
N/A	Set Point Value (SV)	Unit is 0.1 (°C or °F)	R/W	1001	44098	V10001
P3-3	Input Range High	The data content should not be higher than the temperature range.	R/W	1002	44099	V10002
P3-4	Input Range Low	The data content should not be lower than the temperature range.	R/W	1003	44100	V10003
P3-1	Input Type	Please refer to the "Temperature Sensor Type and Temperature Range" table for details.	R/W	1004	44101	V10004
P3-5	Control Mode	0 = PID control 1 = On / Off control 2 = Manual control 3 = Ramp / Soak	R/W	1005	44102	V10005
P3-7	Heating / Cooling	0 = Heating 1 = Cooling 2 = Heating / Cooling 3 = Cooling / Heating	R/W	1006	44103	V10006
P1-11 P1-12	Output 1 Heating Period / Output 1 Cooling Period	0 = 0.5 sec 1 - 99 = 1 - 99 sec	R/W	1007	44104	V10007
P1-13	Output 2 Period	0 = 0.5 sec 1 - 99 = 1 - 99 sec	R/W	1008	44105	V10010
P1-4	Proportion Band	0.1 - 999.9	R/W	1009	44106	V10011
P1-5	Integral Time	0 - 9999	R/W	100A	44107	V10012
P1-6	Derivative Time	0 - 9999	R/W	100B	44108	V10013
P1-8	Integral Offset	0.0 - 100.0%	R/W	100C	44109	V10014
P1-7	PD Control Offset	0.0 - 100.0%	R/W	100D	44110	V10015
P1-14	Proportion Band Coefficient	0.01 - 99.99	R/W	100E	44111	V10016
P1-15	Dead Band	-999 - 9999	R/W	100F	44112	V10017

Data Registers cont.						
ID	Parameter Name	Description	R/W	Hexadecimal	Modbus Decimal	PLC Address (Octal)
P1-9	Heating Hysteresis	0 - 9999	R/W	1010	44113	V10020
P1-10	Cooling Hysteresis	0 - 9999	R/W	1011	44114	V10021
P2-11	Output 1 Level	Unit is 0.1%, write operation is valid under manual tuning mode only.	R/W	1012	44115	V10022
P2-12	Output 2 Level	Unit is 0.1%, write operation is valid under manual tuning mode only.	R/W	1013	44116	V10023
P1-17	Analog High Adjustment	1 Unit = 2.8uA (Current Output) 1 Unit = 1.3 mV (Linear Voltage Output)	R/W	1014	44117	V10024
P1-18	Analog Low Adjustment	1 Unit = 2.8uA (Current Output) 1 Unit = 1.3 mV (Linear Voltage Output)	R/W	1015	44118	V10025
P1-16	PV Offset	-999 - 999	R/W	1016	44119	V10026
P2-3	Decimal Point Position	0 - 3	R/W	1017	44120	V10027
P1-2	PID Parameter Group	0 - 3 = PID parameter group 0 - 3. 4 = PID paramter group auto select	R/W	101C	44125	V10034
P1-3	Target SV	Only valid within available range, unit: 0.1 scale	R/W	101D	44126	V10035
P3-8	Alarm 1	0 = Alarm 1 is disabled. 1- 18 = Alarm type number	R/W	1020	44129	V10040
P3-9	Alarm 2	0 = Alarm 1 is disabled. 1- 18 = Alarm type number	R/W	1021	44130	V10041
P3-10	Alarm 3	0 = Alarm 1 is disabled. 1- 18 = Alarm type number	R/W	1022	44131	V10042
P3-11	System Alarm	0 = System Alarm is disabled. (default) 1 - 3 = Alarm number to also be used as system alarm.	R/W	1023	44132	V10043
P2-4	Alarm 1 High Limit	Please refer to the contents of the "Alarm Outputs" for details.	R/W	1024	44133	V10044
P2-5	Alarm 1 low Limit	Please refer to the contents of the "Alarm Outputs" for details.	R/W	1025	44134	V10045
P2-6	Alarm 2 High Limit	Please refer to the contents of the "Alarm Outputs" for details.	R/W	1026	44135	V10046
P2-7	Alarm 2 Low Limit	Please refer to the contents of the "Alarm Outputs" for details.	R/W	1027	44136	V10047

Data Registers cont.						
ID	Parameter Name	Description	R/W	Hexadecimal	Modbus Decimal	PLC Address (Octal)
P2-8	Alarm 3 High Limit	Please refer to the contents of the "Alarm Outputs" for details.	R/W	1028	44137	V10050
P2-9	Alarm 3 Low Limit	Please refer to the contents of the "Alarm Outputs" for details.	R/W	1029	44138	V10051
N/A	LED Status	Bit 0 = ALM3 Bit 1 = ALM2 Bit 2 = °F Bit 3 = °C Bit 4 = ALM1 Bit 5 = OUT2 Bit 6 = OUT1 Bit 7 = AT	R	102A	44139	V10052
N/A	Pushbutton Status	Bit 0 = SET Bit 1 = Rotate Bit 2 = Up Bit 3 = Down If the button is pressed, the bit is off.	R	102B	44140	V10053
P2-10	Lock Mode	0 = OFF 1 = Lock Mode 1 11 - Lock Mode 2	R/W	102C	44141	V10054
N/A	Firmware Version	V1.00 indicates 0x100	R	102F	44144	V10057
P2-2	Starting Ramp / Soak Pattern	0 - 7	R/W	1030	44145	V10060
P3-21	Last Step Number	0 - 7 = The last step number of the pattern	R/W	1040~ 1047*	44161~ 44168*	V10100~ V10107*
P3-22	Additional Cycles	0 - 199	R/W	1050~ 1057*	44177~ 44184*	V10120~ V10127*
P3-23	Next Pattern Number	0 - 7 = Next pattern number 8 = There is no next pattern.	R/W	1060~ 1067*	44193~ 44200*	V10140~ V10147*
P3-19	Ramp / Soak SV	-999 - 9999	R/W	2000~ 203F*	48193~ 48256*	V20000~ V20077*
P3-20	Ramp / Soak Time	0 - 1500 (15 hours 0 minutes)	R/W	2080~ 20BF*	48321~ 48384*	V20200~ V20277*



*\*Note: The Appendix covers the Modbus address map for the Ramp / Soak Control.*

Bit Registers						
ID	Parameter Name	Description	R/W	Hexadecimal	Modbus Decimal	PLC Address (Octal)
N/A	AT LED status	0 = Off, 1 = On	R	0800	2049	Y0
N/A	Output 1 LED status	0 = Off, 1 = On	R	0801	2050	Y1
N/A	Output 2 LED status	0 = Off, 1 = On	R	0802	2051	Y2
N/A	Alarm 1 LED status	0 = Off, 1 = On	R	0803	2052	Y3
N/A	°F LED status	0 = Off, 1 = On	R	0804	2053	Y4
N/A	°C LED status	0 = Off, 1 = On	R	0805	2054	Y5
N/A	Alarm 2 LED status	0 = Off, 1 = On	R	0806	2055	Y6
N/A	Alarm 3 LED status	0 = Off, 1 = On	R	0807	2056	Y7
N/A	SET key status	0 = Pressed, 1 = Not Pressed	R	0808	2057	Y10
N/A	Function key status	0 = Pressed, 1 = Not Pressed	R	0809	2058	Y11
N/A	UP key status	0 = Pressed, 1 = Not Pressed	R	080A	2059	Y12
N/A	DOWN key status	0 = Pressed, 1 = Not Pressed	R	080B	2060	Y13
N/A	Event 1 input status	0 = Disabled, 1 = Enabled	R	080C	2061	Y14
N/A	Event 2 input status	0 = Disabled, 1 = Enabled	R	080D	2062	Y15
N/A	System Alarm Status	0 = Off, 1 = On	R	080E	2063	Y16
N/A	Ramp / Soak Control status	0 = Ramp / Soak disabled 1 = Ramp / Soak enabled	R	080F	2064	Y17
P3-12	On-Line Configuration	0 = On-Line Configuration is disabled (default) 1 = On-Line Configuration is enabled	R/W	0810	2065	Y20
N/A	Temperature Unit Display Selection	0 = °F 1 = °C / Linear input (default)	R/W	0811	2066	Y21
P2-3	Decimal Point Display Selection	0 = No decimal 1 = 10ths digit decimal (B, S and R type thermocouples use only 0 decimal display.)	R/W	0812	2067	Y22
P1-1	Auto Tuning	0 = Off (default) 1 = On	R/W	0813	2068	Y23
P2-1	Run / Stop the Control	0 = STOP 1 = RUN (default)	R/W	0814	2069	Y24
P2-1	Stop the Ramp / Soak Control	0 = RUN (default) 1 = STOP	R/W	0815	2070	Y25
P2-1	Hold the Ramp / Soak Control	0 = RUN (default) 1 = HOLD	R/W	0816	2071	Y26

Temperature Sensor Type and Temperature Range			
Hex - Address 1004			
Input Sensor type	Register Value	Display	Temperature Range
0 ~ 50 mV Analog Input	17	70	-999 ~ 9999
4 ~ 20 mA Input	16	774	-999 ~ 9999
0 ~ 20 mA Input	15	770	-999 ~ 9999
0 ~ 10 VDC Input	14	010	-999 ~ 9999
0 ~ 5 VDC Input	13	05	-999 ~ 9999
RTD (Pt100) type	12	PT	-328 ~ 1112°F (-200 ~ 600°C)
RTD (IPt100) type	11	IPt	-4 ~ 752°F (-20 ~ 400°C)
Thermocouple TXK type	10	TXK	-328 ~ 1472°F (-200 ~ 800°C)
Thermocouple U type	9	U	-328 ~ 932°F (-200 ~ 500°C)
Thermocouple L type	8	L	-328 ~ 1562°F (-200 ~ 850°C)
Thermocouple B type	7	B	212 ~ 3272°F (100 ~ 1800°C)
Thermocouple S type	6	S	32 ~ 3092°F (0 ~ 1700°C)
Thermocouple R type	5	R	32 ~ 3092°F (0 ~ 1700°C)
Thermocouple N type	4	N	-328 ~ 2372°F (-200 ~ 1300°C)
Thermocouple E type	3	E	32 ~ 1112°F (0 ~ 600°C)
Thermocouple T type	2	T	-328 ~ 752°F (-200 ~ 400°C)
Thermocouple J type	1	J	-148 ~ 2192°F (-100 ~ 1200°C)
Thermocouple K type	0	K	-328 ~ 2372°F (-200 ~ 1300°C)

## Connection with the DirectLOGIC PLC

The following DirectLOGIC PLCs can communicate with the SOLO controller. The DL06 or D2-260 PLCs are preferred for connection with the SOLO controller because they have a built in RS-485 communication port support function code 05.

DirectLogic PLC	Com port	Restriction	Instructions to use	Wiring Diagram
DL05	Port 2 + FA-ISOCON	Can't write to the bit registers because the DL05 does not support the function code 05. Modbus RTU only	RX, WX	Figure 1
	D0-DCM Port2	Can't write to the bit registers if installed in the DL05 because the DL05 does not support the function code 05. Modbus RTU only.	RX, WX	Figure 2
DL06	Port 2	Modbus RTU only	MRX, MWX	Figure 2
	D0-DCM Port2	Modbus RTU only	MRX, MWX	Figure 2
D2-250-1	Port 2 + FA-ISOCON +FA-15HD	Can't write to the bit registers because the D2-250-1 does not support the function code 05.	RX, WX	Figure 3
D2-260	Port 2	Modbus RTU only	MRX, MWX	Figure 2
D3-350	Port 2 + FA-ISOCON	Can't write to the bit registers because the D3-350 does not support the function code 05. Modbus RTU only.	RX, WX	Figure 4
D4-450	Port 1 + FA-ISOCON	Can't write to the bit registers because the D4-450 does not support the function code 05. Modbus RTU only.	RX, WX	Figure 5

Figure 1

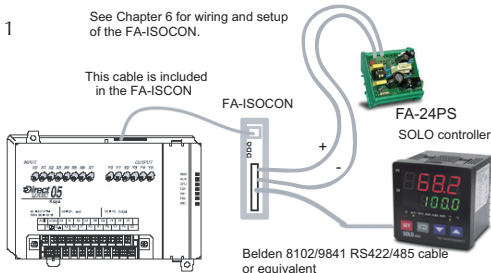

Figure 2

You will need to make this custom cable

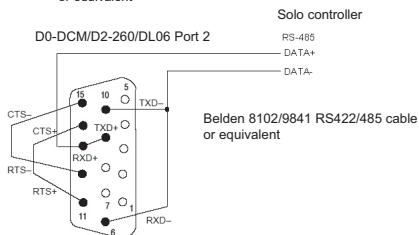



Figure 3

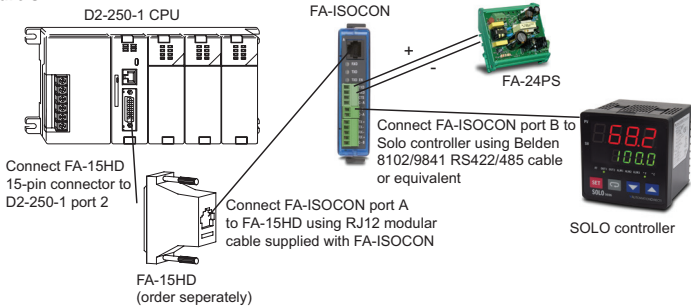

Figure 4

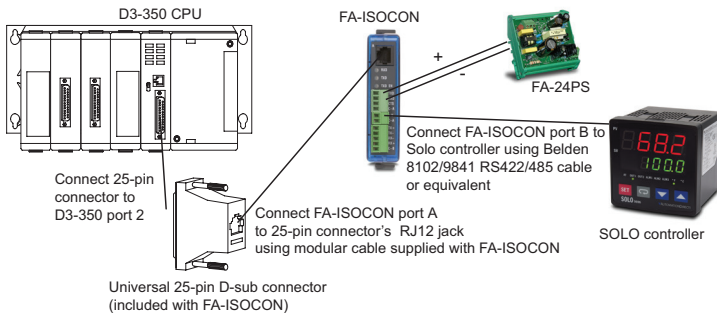
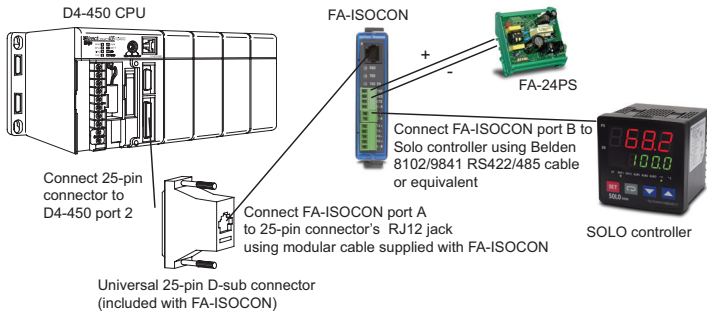
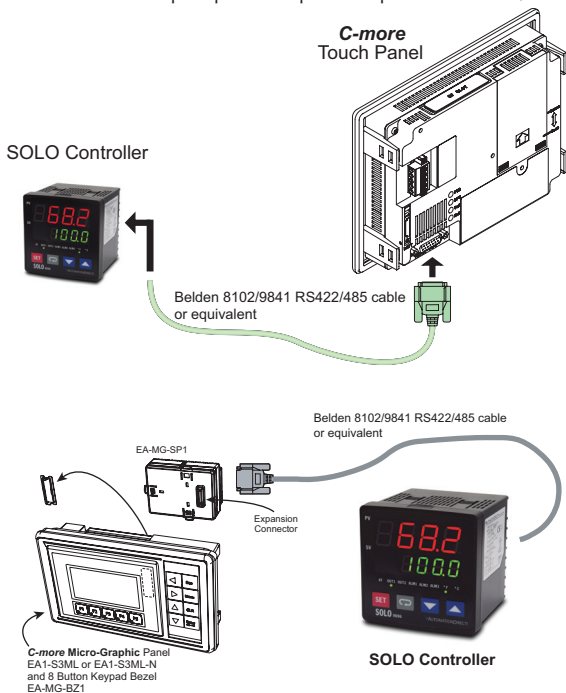

Figure 5



## Connection with the *C-more* and *C-more* Micro HMI panels

Any of the *C-more* and *C-more* Micro-Graphic HMI panels can be connected to the SOLO controllers. The *C-more* HMI panels have a built in RS-485 port. The *C-more* 3" Micro-Graphic panels require an optional module (EA-MG-SP1).



### Serial Communications

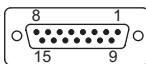

Pin	Signal	Pin	Signal	Pin	Signal
1	Frame GND	6	LE	11	TXD+ (422/485)
2	TXD (232C)	7	CTS (232C)	12	TXD- (422/485)
3	RXD (232C)	8	RTS (232C)	13	Term. Resistor
4	Vcc	9	RXD+ (422/485)	14	do not use
5	Logic GND	10	RXD- (422/485)	15	do not use

*C-more* and *C-more* Micro-Graphic Panel RS-485 port

# MODBUS ADDRESS MAP FOR RAMP / SOAK CONTROL

---



# APPENDIX

## In this Appendix...

Last Step Number.....	A-2
Additional Cycles .....	A-2
Next Pattern Number.....	A-2
Ramp / Soak SV .....	A-3
Ramp / Soak Time .....	A-4

## Last Step Number

(ID: **5P4n**, P3-21)

Pattern Number	Hexadecimal	Modbus Decimal	PLC Address (Octal)
Pattern 0	1040	44161	V10100
Pattern 1	1041	44162	V10101
Pattern 2	1042	44163	V10102
Pattern 3	1043	44164	V10103
Pattern 4	1044	44165	V10104
Pattern 5	1045	44166	V10105
Pattern 6	1046	44167	V10106
Pattern 7	1047	44168	V10107

## Additional Cycles

(ID: **544n**, P3-22)

Pattern Number	Hexadecimal	Modbus Decimal	PLC Address (Octal)
Pattern 0	1050	44177	V10120
Pattern 1	1051	44178	V10121
Pattern 2	1052	44179	V10122
Pattern 3	1053	44180	V10123
Pattern 4	1054	44181	V10124
Pattern 5	1055	44182	V10125
Pattern 6	1056	44183	V10126
Pattern 7	1057	44184	V10127

## Next Pattern Number

(ID: **547n**, P3-23)

Pattern Number	Hexadecimal	Modbus Decimal	PLC Address (Octal)
Pattern 0	1060	44193	V10140
Pattern 1	1061	44194	V10141
Pattern 2	1062	44195	V10142
Pattern 3	1063	44196	V10143
Pattern 4	1064	44197	V10144
Pattern 5	1065	44198	V10145
Pattern 6	1066	44199	V10146
Pattern 7	1067	44200	V10147

## Ramp / Soak SV

(ID: **5Pmn**, P3-19)

### Hexadecimal

	Pattern 0	Pattern 1	Pattern 2	Pattern 3	Pattern 4	Pattern 5	Pattern 6	Pattern 7
Step 0	2000	2008	2010	2018	2020	2028	2030	2038
Step 1	2001	2009	2011	2019	2021	2029	2031	2039
Step 2	2002	200A	2012	201A	2022	202A	2032	203A
Step 3	2003	200B	2013	201B	2023	202B	2033	203B
Step 4	2004	200C	2014	201C	2024	202C	2034	203C
Step 5	2005	200D	2015	201D	2025	202D	2035	203D
Step 6	2006	200E	2016	201E	2026	202E	2036	203E
Step 7	2007	200F	2017	201F	2027	202F	2037	203F

### Modbus Decimal

	Pattern 0	Pattern 1	Pattern 2	Pattern 3	Pattern 4	Pattern 5	Pattern 6	Pattern 7
Step 0	48193	48201	48209	48217	48225	48233	48241	48249
Step 1	48194	48202	48210	48218	48226	48234	48242	48250
Step 2	48195	48203	48211	48219	48227	48235	48243	48251
Step 3	48196	48204	48212	48220	48228	48236	48244	48252
Step 4	48197	48205	48213	48221	48229	48237	48245	48253
Step 5	48198	48206	48214	48222	48230	48238	48246	48254
Step 6	48199	48207	48215	48223	48231	48239	48247	48255
Step 7	48200	48208	48216	48224	48232	48240	48248	48256

### PLC Address (Octal)

	Pattern 0	Pattern 1	Pattern 2	Pattern 3	Pattern 4	Pattern 5	Pattern 6	Pattern 7
Step 0	V20000	V20010	V20020	V20030	V20040	V20050	V20060	V20070
Step 1	V20001	V20011	V20021	V20031	V20041	V20051	V20061	V20071
Step 2	V20002	V20012	V20022	V20032	V20042	V20052	V20062	V20072
Step 3	V20003	V20013	V20023	V20033	V20043	V20053	V20063	V20073
Step 4	V20004	V20014	V20024	V20034	V20044	V20054	V20064	V20074
Step 5	V20005	V20015	V20025	V20035	V20045	V20055	V20065	V20075
Step 6	V20006	V20016	V20026	V20036	V20046	V20056	V20066	V20076
Step 7	V20007	V20017	V20027	V20037	V20047	V20057	V20067	V20077

## Ramp / Soak Time

(ID: **mn**, P3-20)

Hexadecimal

	Pattern 0	Pattern 1	Pattern 2	Pattern 3	Pattern 4	Pattern 5	Pattern 6	Pattern 7
Step 0	2080	2088	2090	2098	20A0	20A8	20B0	20B8
Step 1	2081	2089	2091	2099	20A1	20A9	20B1	20B9
Step 2	2082	208A	2092	209A	20A2	20AA	20B2	20BA
Step 3	2083	208B	2093	209B	20A3	20AB	20B3	20BB
Step 4	2084	208C	2094	209C	20A4	20AC	20B4	20BC
Step 5	2085	208D	2095	209D	20A5	20AD	20B5	20BD
Step 6	2086	208E	2096	209E	20A6	20AE	20B6	20BE
Step 7	2087	208F	2097	209F	20A7	20AF	20B7	20BF

Modbus Decimal

	Pattern 0	Pattern 1	Pattern 2	Pattern 3	Pattern 4	Pattern 5	Pattern 6	Pattern 7
Step 0	48321	48329	48337	48345	48353	48361	48369	48377
Step 1	48322	48330	48338	48346	48354	48362	48370	48378
Step 2	48323	48331	48339	48347	48355	48363	48371	48379
Step 3	48324	48332	48340	48348	48356	48364	48372	48380
Step 4	48325	48333	48341	48349	48357	48365	48373	48381
Step 5	48326	48334	48342	48350	48358	48366	48374	48382
Step 6	48327	48335	48343	48351	48359	48367	48375	48383
Step 7	48328	48336	48344	48352	48360	48368	48376	48384

PLC Address (Octal)

	Pattern 0	Pattern 1	Pattern 2	Pattern 3	Pattern 4	Pattern 5	Pattern 6	Pattern 7
Step 0	V20200	V20210	V20220	V20230	V20240	V20250	V20260	V20270
Step 1	V20201	V20211	V20221	V20231	V20241	V20251	V20261	V20271
Step 2	V20202	V20212	V20222	V20232	V20242	V20252	V20262	V20272
Step 3	V20203	V20213	V20223	V20233	V20243	V20253	V20263	V20273
Step 4	V20204	V20214	V20224	V20234	V20244	V20254	V20264	V20274
Step 5	V20205	V20215	V20225	V20235	V20245	V20255	V20265	V20275
Step 6	V20206	V20216	V20226	V20236	V20246	V20256	V20266	V20276
Step 7	V20207	V20217	V20227	V20237	V20247	V20257	V20267	V20277

