

Pressure switch for gas DG

Technical Information · GB
4 Edition 06.17

- Monitoring of gas and air pressures (positive, negative and differential pressures)
- Certified for systems up to SIL 3 and PL e
- With approved isolating amplifier for Zone 1 and 2 hazardous areas
- EU certified pursuant to EN 1854 and class “S”
- DG..S: special version available for NH₃ and O₂



Contents

Pressure switch for gas DG	1	6.1 Fastening set with screws, U-shape bracket	19
Contents	2	6.2 Connecting set	19
1 Application	4	6.3 External adjustment	19
1.1 Application examples	5	6.4 Pressure equalization element	20
1.1.1 Low gas pressure monitoring	5	6.5 Filter pad set	20
1.1.2 Differential pressure monitoring	5	6.6 Test key PIA	20
1.1.3 Systems leak tightness check	5	6.7 Filter pad set	20
1.1.4 Negative pressure monitoring	5	6.8 Tube set	21
1.1.5 Air line with minimum pressure and flow monitoring	6	6.9 Standard socket set	21
1.1.6 Low or high gas pressure protection device	6	6.10 Standard coupler plug	21
2 Certification	7	6.11 Pilot lamp set, red or blue	21
2.1 Overview	8	6.12 LED set, red/green	21
3 Function	9	6.13 Weather protection cover	22
3.1 Positive pressure measurement	9	7 Technical data	23
3.2 Negative pressure measurement	9	7.1 Adjusting range, switching hysteresis	25
3.3 Differential pressure measurement	9	7.2 Safety-specific characteristic values for DG	27
3.4 Connection diagram	10	7.2.1 Determining the PFH_D value, the λ_D value and the	
3.4.1 Blue pilot lamp for 230 V AC or for 120 V AC	10	MTTF _d value	28
3.4.2 Pilot lamp with plug	10	7.2.2 Calculating the PFH_D and PFD_{avg}	28
3.4.3 Red/green pilot LED for 24 V DC/AC or for 230 V		7.3 Dimensions	29
AC	10	8 Maintenance cycles	29
3.4.4 Pilot LED with plug	10		
3.5 Wiring	11		
3.6 DG in Zone 1 (21) and 2 (22) hazardous areas	12		
3.7 DG on pipes with Zone 2 (22) explosive			
atmospheres	13		
3.8 Animation	14		
4 Selection	15		
4.1 Selection table	15		
4.2 Type code	16		
5 Project planning information	17		
5.1 Installation	17		
6 Accessories	19		

9 Glossary	30
9.1 Diagnostic coverage DC	30
9.2 Mode of operation	30
9.3 Category	30
9.4 Common cause failure CCF	30
9.5 Fraction of undetected common cause failures β	30
9.6 B_{10d} value	30
9.7 T_{10d} value	30
9.8 Hardware fault tolerance HFT	31
9.9 Mean dangerous failure rate λ_D	31
9.10 Safe failure fraction SFF	31
9.11 Probability of dangerous failure PFH_D	31
9.12 Mean time to dangerous failure $MTTF_d$	31
9.13 Demand rate n_{op}	31
9.14 Average probability of dangerous failure on demand PFD_{avg}	31
Feedback	32
Contact	32

1 Application



DG..U-3

Adjustable switching point

DG..H, DG..N

DG..H: switches and locks off with rising pressure. DG..N: switches and locks off with falling pressure. Manual reset.

DG..-6

With fitted socket pursuant to DIN EN 175301-803

DG..T

Hand wheel with "WC and mbar scale. NPT conduit for electrical connection.

The gas pressure switch DG monitors extremely low pressure differentials and triggers switch-on, switch-off or switch-over operations if a set switching point is reached. The switching point is adjustable via a hand wheel.

It monitors positive and negative gas pressures on various industrial gas and air appliances, such as boiler fan monitoring and differential pressure monitoring in firing, ventilation and air-conditioning systems.

The TÜV-tested special-design pressure switch is used as defined by VdTÜV Code of Practice "Druck 100/1" (Pressure 100/1) in firing installations for steam and hot-water generators in accordance with TRD 604, Para. 3.6.4, as

well as class "S" for DG..B, DG..U and DG..I pursuant to EN 1854.

Type	Positive pressure	Negative pressure
DG..B	Gas, air, flue gas or biogas	-
DG..U, DG..T	Gas, air, flue gas or biogas	Air or flue gas
DG..H, DG..N, DG..HT, DG..NT	Gas, air, flue gas or biogas	Air or flue gas
DG..I	Air or flue gas	Gas, air, flue gas or biogas
DG..S	NH ₃ or O ₂	-

1.1 Application examples

1.1.1 Low gas pressure monitoring

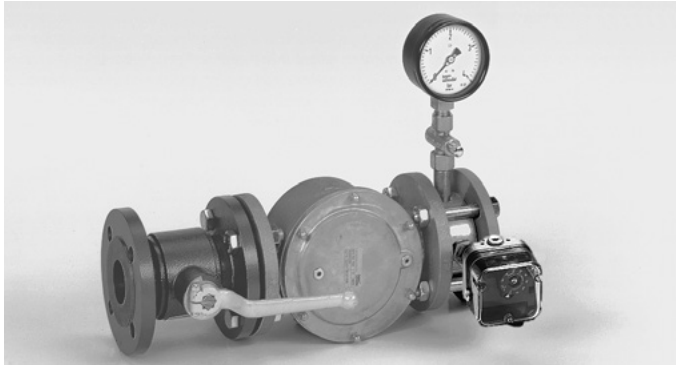

For monitoring the minimum gas inlet pressure

1.1.2 Differential pressure monitoring

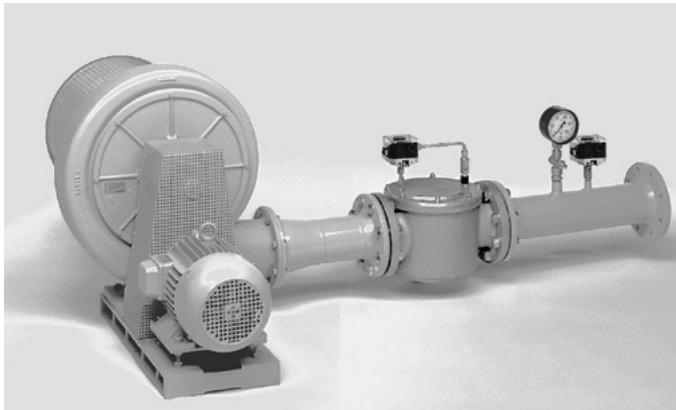

Differential pressure switch for monitoring air filters

1.1.3 Systems leak tightness check

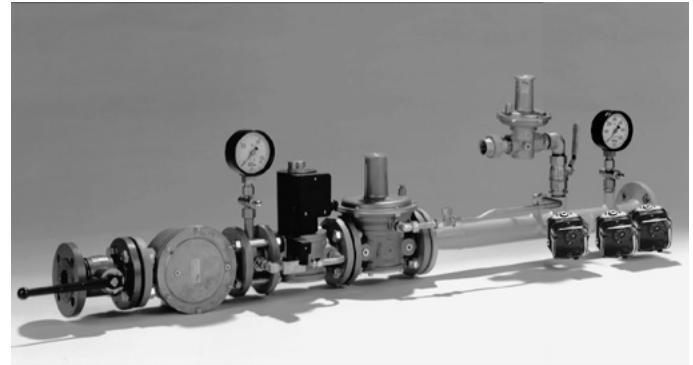

Electronic safety shut-off valve SAV with closed position check of downstream devices

1.1.4 Negative pressure monitoring



Monitoring the negative pressure ensures the correct positioning of the components during fully automatic assembly of gas meters.

1.1.5 Airline with minimum pressure and flow monitoring

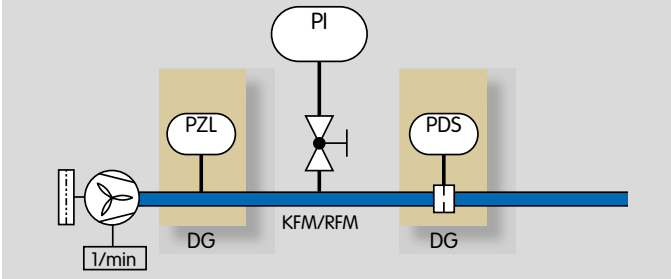

The air flow generated by the fan may be monitored as follows:

The static pressure is monitored by pressure switch DG (PZL) as long as it can be demonstrated that the display consequently shows an adequate and secured flow of air, or the pressure switch DG (PDS) controls the flow of air via the differential pressure on the orifice.

If there is no air pressure supplied or if there is no differential pressure on the orifice, the system will be blocked.

1.1.6 Low or high gas pressure protection device

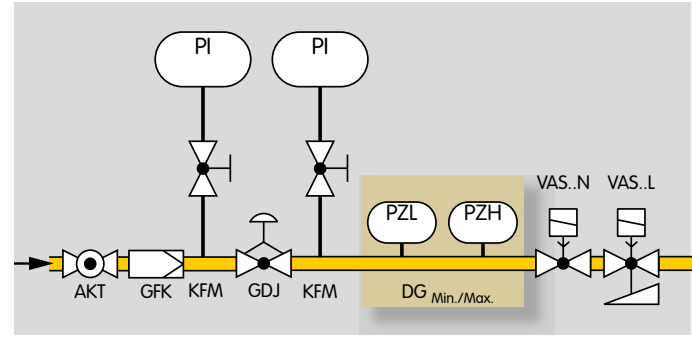

If the pressure is either too low or too high, the min./max. pressure switch DG (PZL/PZH) switches in order to avoid start-up or to initiate a safety shut-down.

2 Certification

Certificates – see Docuthek

Certified to SIL and PL*



For systems up to SIL 3 pursuant to EN 61508 and PL e pursuant to ISO 13849

EU certified pursuant to*



Directive:

- Gas Appliances Directive 2009/142/EC (valid until 20 April 2018) in conjunction with EN 1854, Class “S”

Meets the requirements of the

- Low Voltage Directive (2014/35/EU)

Regulation:

- Gas Appliances Regulation (EU) 2016/426 (valid from 21 April 2018)

AGA approved*



Australian Gas Association, Approval No.: 5484

http://www.aga.asn.au/product_directory

Eurasian Customs Union*



The product DG meets the technical specifications of the Eurasian Customs Union.

DG..T: FM approved*



Factory Mutual Research Class: 3510 Flow and pressure safety switches. Designed for applications pursuant to NFPA 85 and NFPA 86. www.approvalguide.com

DG..T: UL approved*

USA and Canada









UL 353 Limit control.

Underwriters Laboratories – www.ul.com → Tools (at the bottom of the page) → Online Certifications Directory

* Approval does not apply to DG..S. DG..S complies with the requirements of the Low Voltage Directive (2006/95/EC).

2.1 Overview

	DG..B, DG..U, DG..H, DG..N, DG..I	DG..T, DG..HT, DG..NT	DG..S
	●	●	-
	●	-	●
	●	-	-
	●	-	-
	●	-	-
	-	●*	-
	-	●*	-

* FM approved or UL listed

3 Function

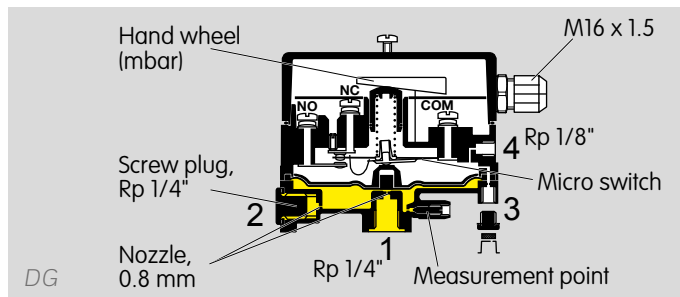

DG

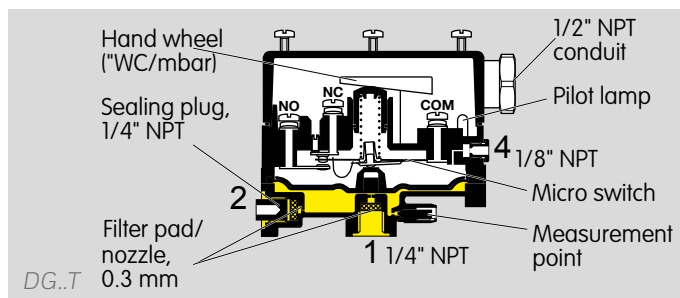

DG..T

The pressure switch DG switches in the event of increasing or decreasing pressure. Once the set switching point is reached, a micro switch is activated in the DG which is designed as a change-over contact.

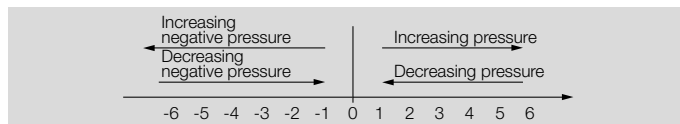

The switching pressure is adjusted using a hand wheel.

3.1 Positive pressure measurement

Positive pressure measurement is designed, for example, for checking the fan function or measuring the min./max. gas pressure.

The positive pressure is measured in the lower diaphragm chamber, port 1 or 2.

The upper diaphragm chamber is ventilated via port 3 or 4.

3.2 Negative pressure measurement

Negative pressure measurement (air, flue gas) is designed, for example, for monitoring a suction pressure blower. The negative pressure is measured in the upper diaphragm chamber, port 3 or 4, and on DG..T via port 4. The lower diaphragm chamber is ventilated via port 1 or 2.

In the case of DG..I, the negative pressure (gas, air, flue gas or biogas) is measured in the lower diaphragm chamber, port 1 or 2. The upper diaphragm chamber is ventilated via port 3 or 4.

3.3 Differential pressure measurement

Differential pressure measurement is designed, for instance, for safeguarding an air flow rate or for monitoring filters and fans.

DG..U, DG..H, DG..N: the higher absolute pressure is connected to port 1 or 2, and the lower absolute pressure to port 3 or 4. The remaining ports must be tightly plugged.

3.4 Connection diagram

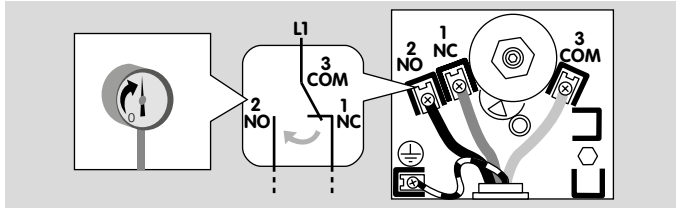

Contacts 3 and 2 close when subject to increasing pressure. Contacts 1 and 3 close when subject to falling pressure.

All DG models (except DG..N) switch with rising pressure. The contact switches from NC 1 to NO 2.

DG..N switches with falling pressure. The contact switches from NO 2 to NC 1.

DG..H and DG..N are locked off in their switched state and can only be unlocked with a manual reset.

3.4.1 Blue pilot lamp for 230 V AC or for 120 V AC

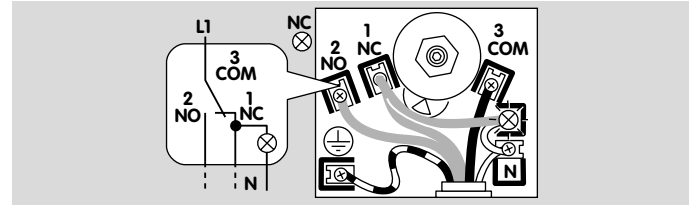
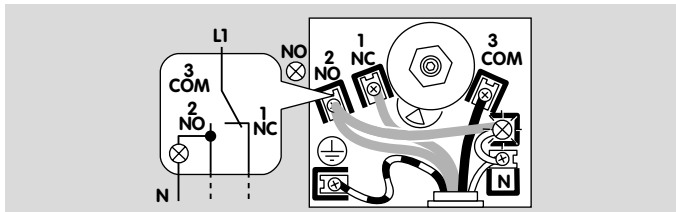

3.4.2 Pilot lamp with plug

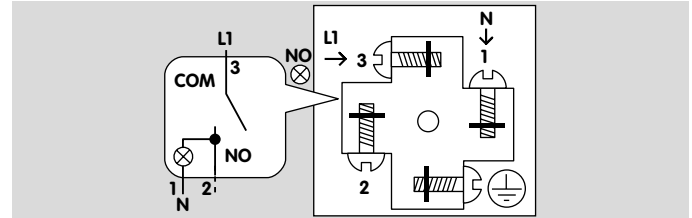

3.4.3 Red/green pilot LED for 24 V DC/AC or for 230 V AC

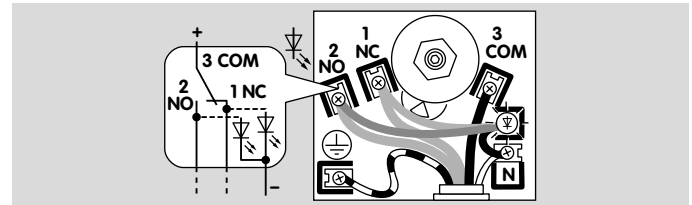

3.4.4 Pilot LED with plug

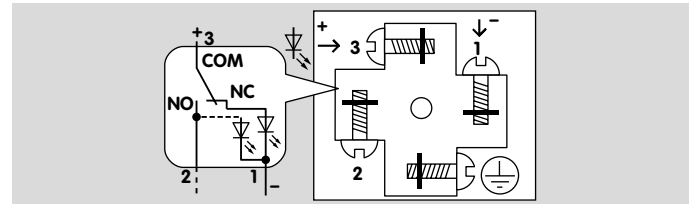

3.5 Wiring

If the DG..G has switched a voltage $> 24\text{ V}$ and a current $> 0.1\text{ A}$ at $\cos \varphi = 1$ or $> 0.05\text{ A}$ at $\cos \varphi = 0.6$ once, the gold plating on the contacts will have been burnt through. It can then only be operated at this power rating or higher power rating.

When using silicone tubes, only use silicone tubes which have been sufficiently cured. Vapours containing silicone can adversely affect the functioning of electrical contacts. In the case of low switching capacities, such as 24 V , 8 mA , for example, we recommend using an RC module ($22\ \Omega$, $1\ \mu\text{F}$) in air containing silicone or oil.

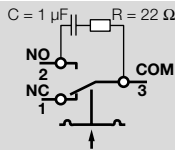

In the case of high humidity or aggressive gas components (H_2S), we recommend using a pressure switch with gold contact due to its higher resistance to corrosion. Closed-circuit current monitoring is recommended under difficult operating conditions.

All DG models (except DG..I)

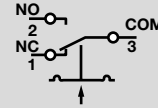

Contacts 3 and 2 close when subject to increasing pressure. Contacts 1 and 3 close when subject to falling pressure.

DG 18I, DG 120I, DG 450I

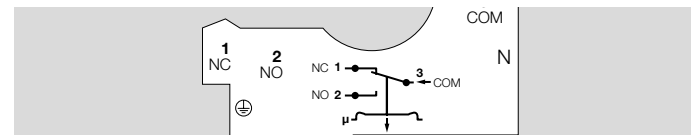

Contacts 3 and 2 close when subject to increasing negative pressure. Contacts 1 and 3 close when subject to falling negative pressure.

DG 1,5I and DG 12I

The connection of DG 1,5I and DG 12I depends on the positive or negative adjusting range.

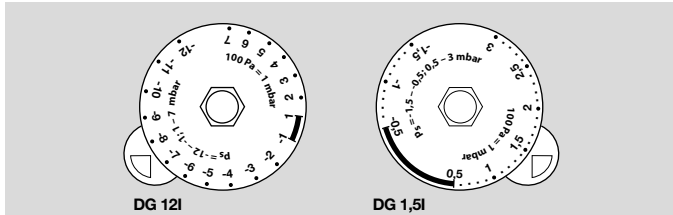

In the negative adjusting range, the template which can be found in the unit displays the connection diagram.

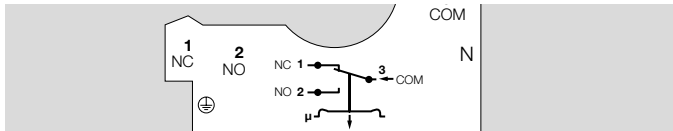

In the positive adjusting range, remove the template and wire the unit as shown in the engraved connection diagram.

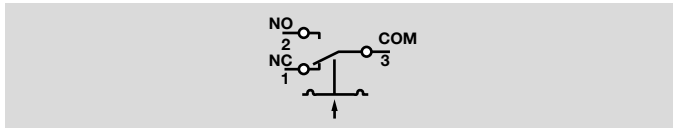

3.6 DG in Zone 1 (21) and 2 (22) hazardous areas

Pressure switch DG can be used in Zone 1 (21) and 2 (22) hazardous areas if an isolating amplifier is installed upstream in the safe area as “Ex-i” equipment pursuant to EN 60079-11 (VDE 0170-7).

DG as “simple electrical equipment” pursuant to EN 60079-11 corresponds to the Temperature class T6, Group II. The internal inductance/capacitance is $L_i = 0.2 \mu\text{H}/C_i = 8 \text{ pF}$.

The isolating amplifier transfers the DG’s signals from the explosion-hazard area to the safe area. Depending on the design of the intrinsically safe circuit, the explosion-hazard area can be monitored for cable faults, cable discontinuities or short-circuits.

Ensure that standard-compliant wiring pursuant to EN 60079 is used.

When operating in Zones 21 and 22, the 1/8" connecting thread or the tube connection for the surrounding air or medium connection must be protected from dirt particles by a separate filter.

Intrinsically safe circuit without monitoring for cable faults

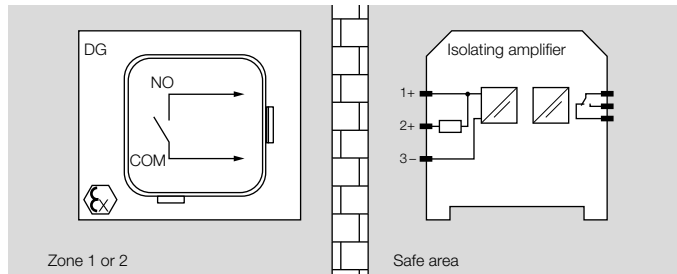

Intrinsically safe circuit with monitoring for cable faults and short-circuits

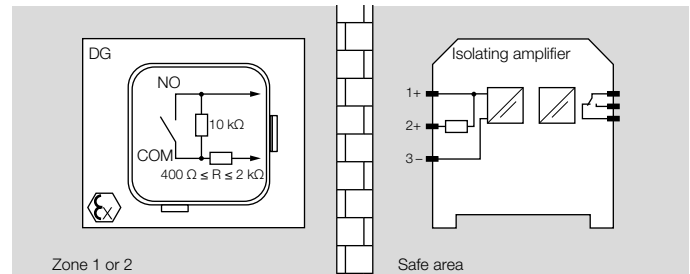

Intrinsically safe circuit with monitoring for cable discontinuities

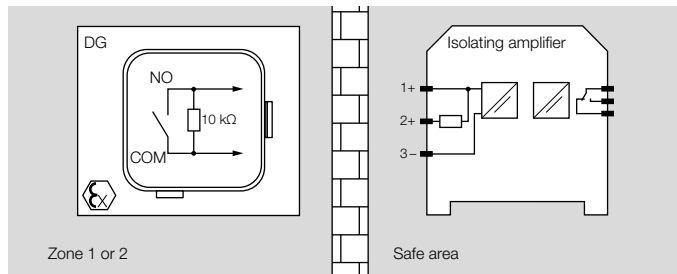

3.7 DG on pipes with Zone 2 (22) explosive atmospheres

Pressure switch DG can be connected to pipes/rooms in which Zone 2 (22) explosive gases or dust are present without an isolating amplifier.

The connection to Zone 2, Zone 22 must be implemented via one of the two 1/4" threads. Even in the unlikely event of a break in the diaphragm, there is no danger of flashback into the system. The pressure compensation holes on the pressure switch (1/4" connections) have a defined ignition protection, in terms of the safety measure for "enclosed-break devices for Group IIA gases and vapours", pursuant to IEC/EN 60079-15.

In the case of Zone 22, it must be ensured that dirt particles do not block the pressure supply hole ($\varnothing = 0.8 \text{ mm}$).

3.8 Animation

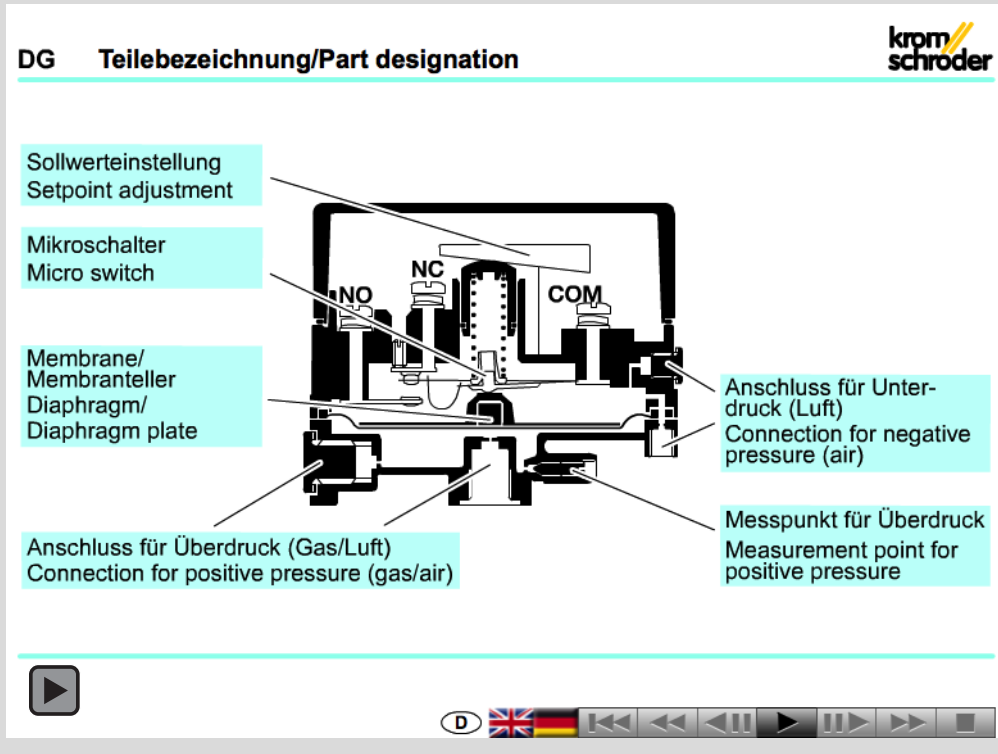

The interactive animation shows the function of the gas pressure switch DG.

Click on the picture. The animation can be controlled using the control bar at the bottom of the window (as on a DVD player).

To play the animation, you will need Adobe Reader 7 or a newer version. If you do not have Adobe Reader on your system, you can download it from the Internet.

If the animation does not start to play, you can download it from the document library (Docuthek) as an independent application.

4 Selection

4.1 Selection table

DG..B for positive pressure

DG..U for positive pressure, negative pressure and differential pressure

Type	6	10	30	50	150	400	500	B	U	G	-3	-4	-5	-6	-7	-8	-9	K2	T	T2	N	A	
DG	●	●	●	●	●	●	●	●	●	●	●	●	○	●	○	○	○	○	○	○	○	○	○

Order example ● = standard, ○ = available

DG 10UG-3K2

DG..H, DG..N for positive pressure, negative pressure and differential pressure

DG..H locks off with rising pressure, DG..N locks off with falling pressure

Type	6	10	30	50	150	400	500	H	N	G	-3	-4	-5	-6	-7	-8	-9	K2	T	T2	N	A	
DG		●		●	●		●	●	●	○	●	●	○	●	○	○	○	○	○	○	○	○	○

DG..S for positive pressure, for oxygen and ammonia (without approval)

Type	6	10	30	50	150	400	500	S	G	-3	-4	-5	-6	-7	-8	-9	K2	T	N	A		
DG	●	●	●	●	●	●	●	●	○	●	○	○	○	○	○	○	○	○	○	○	○	○

DG..I for negative pressure

Type	1,5	12	18	120	450	I	G	-3	-4	-5	-6	-7	-8	K2	T	N	A
DG	●	●	●	●	●	●	●	●	●	○	○	○	○	○	○	○	○

DG..T for positive pressure, negative pressure and differential pressure, with NPT connection

Type	6	10	50	150	500	T*	G**	S
DG	●	●	●	●	●	●	●	○

DG..HT, DG..NT for positive pressure, negative pressure and differential pressure

DG..HT locks off with rising pressure, DG..NT locks off with falling pressure

Type	6	10	50	150	500	H	N	T*	G**	S
DG		●	●	●	●	●	●	●	●	

* On DG..T, the blue pilot lamp for 120 V AC is fitted.

** On DG..TG, the red/green pilot LED for 24 V DC/AC is fitted.

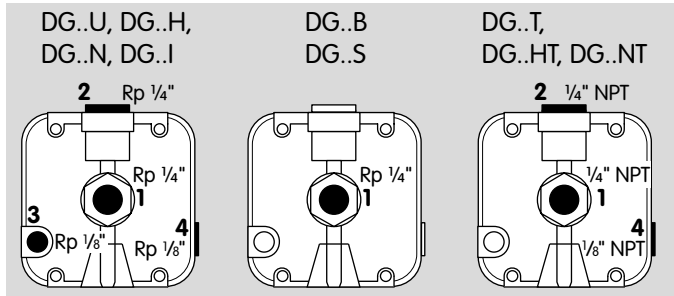

DG..U, DG..H, DG..N, DG..I:
 ports **1** and **2**: Rp 1/4" (standard),
 ports **3** and **4**: Rp 1/8" (standard).

DG..B, DG..S:
 port **1**: Rp 1/4" (standard).

DG..T, DG..HT, DG..NT:
 port **1**: 1/4" NPT (standard) or
 ports **1** and **2**: 1/4" NPT (available),
 port **4**: 1/8" NPT (standard).

4.2 Type code

Code	Description
DG	Pressure switch for gas
1,5	Negative pressure, adjusting range -1.5 to -0.5/+0.5 to +3 mbar
6	Adjusting range 0.4 to 6 mbar
10	Adjusting range 1 to 10 mbar
12	Negative pressure, adjusting range -12 to -1/+1 to +7 mbar
18	Negative pressure, adjusting range -2 to -18 mbar
30	Adjusting range 2.5 to 30 mbar
50	Adjusting range 2.5 to 50 mbar
120	Negative pressure, adjusting range -10 to -120 mbar
150	Adjusting range 30 to 150 mbar
400	Adjusting range 50 to 400 mbar
450	Negative pressure, adjusting range -80 to -450 mbar
500	Adjusting range 100 to 500 mbar
B	Positive pressure
U	Positive pressure, negative pressure, differential pressure
H	Locks off with rising pressure
N	Locks off with falling pressure
I	Negative pressure for gas
S	Positive pressure only, for oxygen and ammonia
T	T-product
G	With gold-plated contacts
-3	Electrical connection: via screw terminals
-4	via screw terminals, IP 65
-5	via 4-pin plug, without socket
-6	via 4-pin plug, with socket
-9	via 4-pin plug, with socket, IP 65
K2	Red/green pilot LED for 24 V DC/AC
T	Blue pilot lamp for 230 V AC
T2	Red/green pilot LED for 230 V AC
N	Blue pilot lamp for 120 V AC
A	External adjustment







Adjusting range, see page 25 (Adjusting range, switching hysteresis)

5 Project planning information

5.1 Installation

Installation in the vertical or horizontal position, or sometimes upside down, preferably with vertical diaphragm.

If installed in a vertical position, the switching point p_S will correspond to the scale value SK set on the hand wheel. If installed in another position, the switching point p_S will change and no longer correspond to the scale value SK set on the hand wheel. Switching point p_S must be checked.

		
All DG models (except DG..I)		
$p_S = SK$	$p_S = SK + 0.18 \text{ mbar}$	$p_S = SK - 0.18 \text{ mbar}$
DG 1,5I		
$p_S = SK$	$p_S = SK + 0.4 \text{ mbar}$ e.g. SK = 1.2: $p_S = 1.2 + 0.4 = 1.6 \text{ mbar}$ $p_S = SK - 0.4 \text{ mbar}$ e.g. SK = -1.2: $p_S = -1.2 + 0.4 = -0.8 \text{ mbar}$	
DG 12I		
$p_S = SK$	$p_S = SK + 0.5 \text{ mbar}$ e.g. SK = 5: $p_S = 5 + 0.5 = 5.5 \text{ mbar}$ $p_S = SK - 0.5 \text{ mbar}$ e.g. SK = -10: $p_S = -10 + 0.5 = -9.5 \text{ mbar}$	
DG 18I, DG 120I, DG 450I		
$p_S = SK$	DG 18I: $p_S = SK + 0.5 \text{ mbar}$ e.g. SK = -10: $p_S = -10 + 0.5 = -9.5 \text{ mbar}$ DG 120I, DG 450I: $p_S = SK + 0.2 \text{ mbar}$	

The housing must not be in contact with masonry. Minimum clearance 20 mm.

The DG..S is suitable for oxygen and ammonia only (diaphragm made of IIR). Do not use for fuel gases – diaphragm not resistant! In the case of oxygen, ensure grease-free installation.

Continuous operation at high temperatures (e.g. maximum ambient temperature) accelerates the ageing of elastomer materials and reduces the service life (please contact manufacturer). Ozone concentrations exceeding $200 \mu\text{g}/\text{m}^3$ or gases containing more than 0.1%-by-vol. H_2S accelerate the ageing of elastomer materials and reduce the service life.

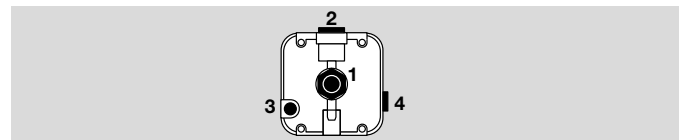

Ports 3 and 4 are connected to the micro switch chamber. The port that is best protected against soiling (dust/humidity) is to be left open for ventilation (positive pressure measurement) to the atmosphere. If dust exposure in the environment is high, a filter pad, see page 20 (Filter pad set), or a filter are to be used in the open port.

Combustion gas or a mixture of combustion gas and air must not be connected to port 3 or 4.

Project planning information

Condensation must not be allowed to get into the housing (if possible, install pipework with an ascending gradient). Otherwise, there is a risk of icing of condensation at subzero temperatures, the switching point shifting or corrosion in the device which can lead to malfunctions.

When installing outdoors, place the DG in a roofed area and protect from direct sunlight (even IP 65 version). To avoid condensation, the cover with pressure equalization element can be used, see page 20 (Pressure equalization element).

The weather protection cover provides permanent protection when installed outdoors, see page 22 (Weather protection cover).

In case of highly fluctuating pressures, install a restrictor orifice, see page 20 (Filter pad set).

6 Accessories

6.1 Fastening set with screws, U-shape bracket

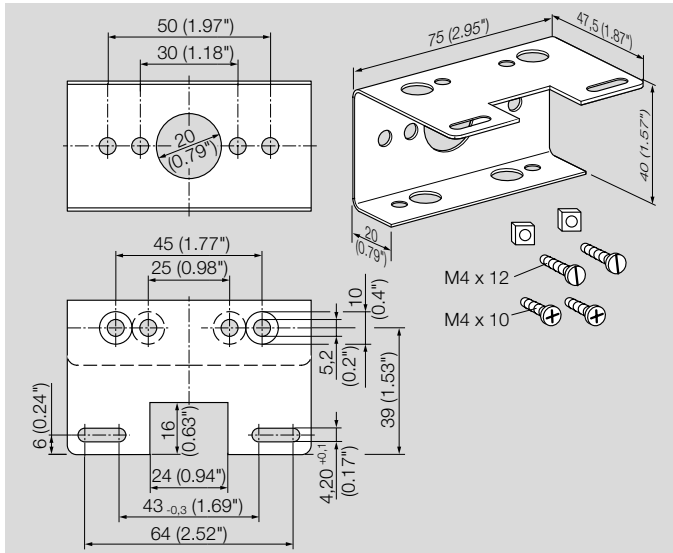

For DG..B, DG..U, DG..I: Order No.: 74915387

6.2 Connecting set

DG..U, DG..H, DG..N, DG..I



For monitoring a minimum and maximum inlet pressure with two pressure switches attached to one another.

Order No.: 74912250

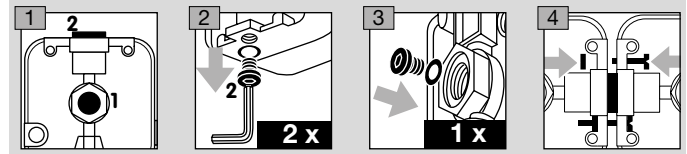

6.3 External adjustment



In order to set the switching pressure from the outside, the cover for external adjustment (6 mm Allen key) for DG..B, DG..U and DG..I can be retrofitted.

Order No.: 74916155

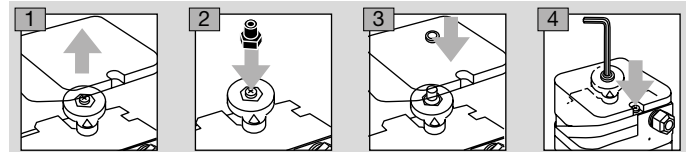

6.4 Pressure equalization element

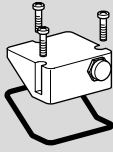

To avoid the formation of condensation, the cover with pressure equalization element can be used. The diaphragm in the screw connector is designed to ventilate the cover, without allowing water to enter.

Order No.: 74923391

6.5 Filter pad set

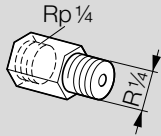

In the case of high pressure fluctuations, we recommend using a restrictor orifice (contains non-ferrous metals):

Hole diameter 0.2 mm, Order No.: 75456321

Hole diameter 0.3 mm, Order No.: 75441317

6.6 Test key PIA

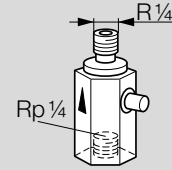

To test the min. pressure switch, the DG can be vented in its switched state using the PIA test key (contains non-ferrous metals).

Order No.: 74329466

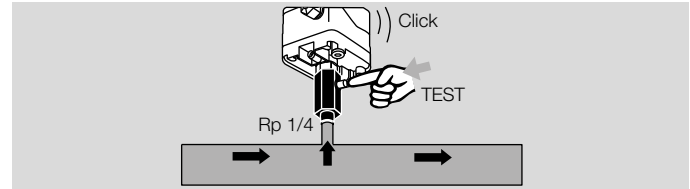

6.7 Filter pad set

To protect the electrical contacts in the DG from dirt particles in the surrounding air or in the medium, use a filter pad at the 1/8" negative pressure port. As standard on IP 65 units.

5-piece filter pad set, Order No.: 74916199

6.8 Tube set

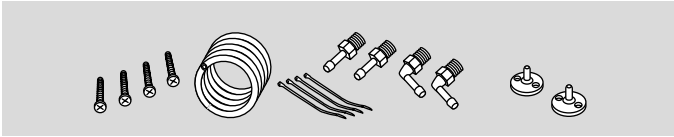

To be used with air only.

Order No.: 74912952

6.9 Standard socket set

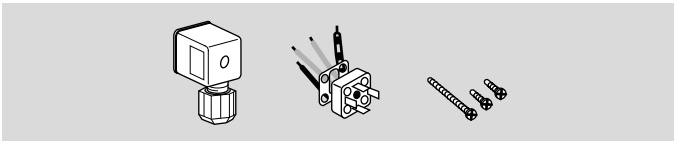

Order No.: 74915388

6.10 Standard coupler plug

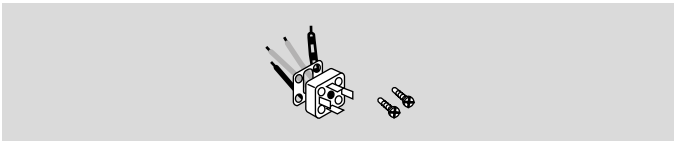

Order No.: 74920412

6.11 Pilot lamp set, red or blue

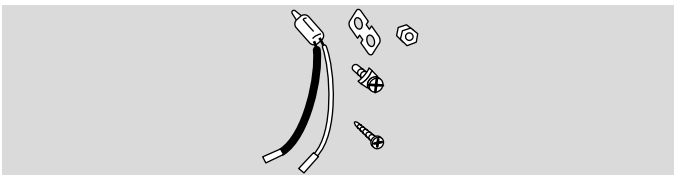

Pilot lamp, red:

110/120 V AC, I = 1.2 mA, Order No.: 74920430

220/250 V AC, I = 0.6 mA, Order No.: 74920429

Pilot lamp, blue:

110/120 V AC, I = 1.2 mA, Order No.: 74916121

220/250 V AC, I = 0.6 mA, Order No.: 74916122

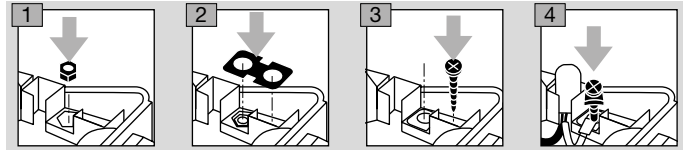

6.12 LED set, red/green

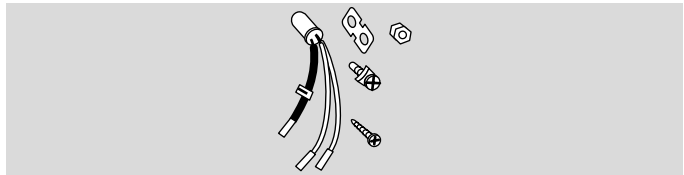

24 V DC, I = 16 mA; 24 V AC, I = 8 mA, Order No.:

74921089

230 V AC, I = 0.6 mA, Order No.: 74923275

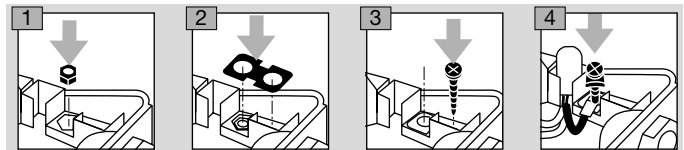

6.13 Weather protection cover

When the DG is installed outdoors, the weather protection cover provides permanent protection against condensation and weathering of housing parts.

The weather protection cover is made of 1 mm-thick stainless steel.

Installation position: vertical with the cable gland pointing downwards.

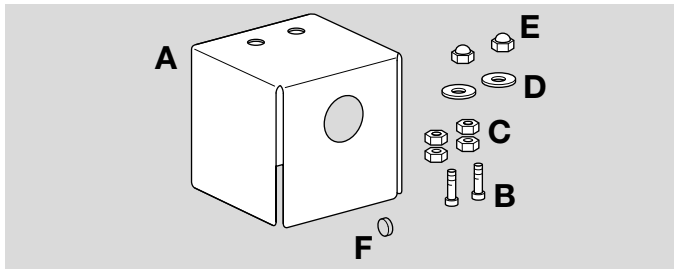

2 M4 x 16 screws with 2 cap nuts.

The enclosed filter pad is designed to protect the open $\frac{1}{8}$ " port from the ingress of dirt or insects.

Scope of delivery:

A 2 x covers, 100 x 100 x 100 mm

B 2 x M4 x 16 screws

C 4 x nuts

D 2 x washers

E 2 x cap nuts

F 1 x filter pad ($\frac{1}{8}$ " port)

Order No.: 74924909.

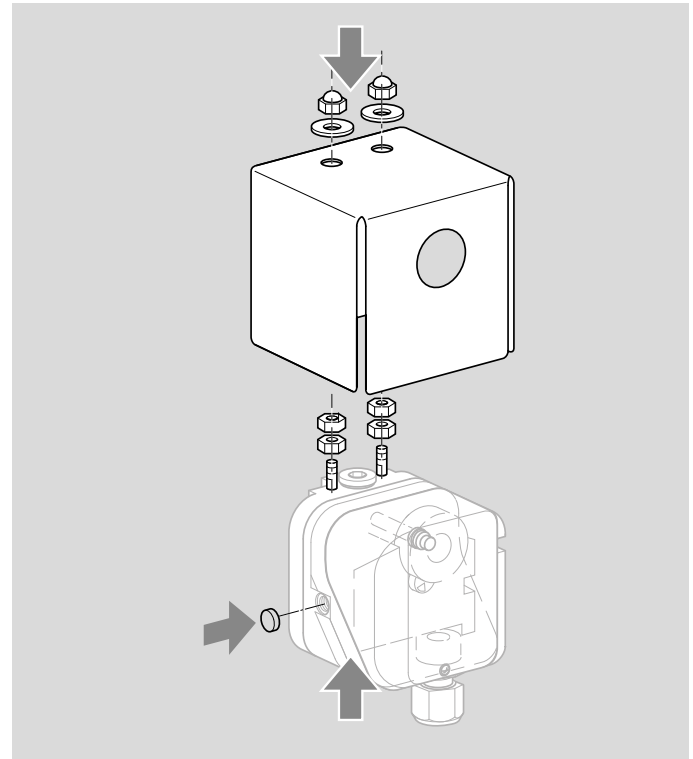

7 Technical data

Gas type: natural gas, town gas, LPG (gaseous), flue gas, biogas (max. 0.1%-by-vol. H₂S) and air.

DG: max. inlet pressure p_{\max} = withstand pressure, see page 25 (Adjusting range, switching hysteresis).

Max. test pressure for testing the entire system: temporarily < 15 minutes 2 bar (29 psig).

Switching capacity:

DG:

$U = 24 - 250 \text{ V AC}$,

$I = 0.05 - 5 \text{ A at } \cos \varphi = 1$,

$I = 0.05 - 1 \text{ A at } \cos \varphi = 0.6$.

DG..G:

$U = 5 - 250 \text{ V AC}$,

$I = 0.01 - 5 \text{ A at } \cos \varphi = 1$,

$I = 0.01 - 1 \text{ A at } \cos \varphi = 0.6$.

DG..G:

$U = 5 - 48 \text{ V DC}$,

$I = 0.01 - 1 \text{ A}$.

DG..T:

$U = 30 - 240 \text{ V AC}$,

$I = 5 \text{ A at } \cos \varphi = 1$,

$I = 0.5 \text{ A at } \cos \varphi = 0.6$.

DG..TG:

$U = < 30 \text{ V AC}$,

$I = 0.1 \text{ A at } \cos \varphi = 1$,

$I = 0.05 \text{ A at } \cos \varphi = 0.6$.

If the DG (DG..TG) has switched a voltage > 24 V (> 30 V) and a current > 0.1 A at $\cos \varphi = 1$ or > 0.05 A at $\cos \varphi = 0.6$ once, the gold plating on the contacts will have been burnt through. It can then only be operated at this power rating or higher power rating.

Maximum medium and ambient temperatures:

DG..B, DG..U, DG..I: -20 to +80°C (-4 to +176°F),

DG..S: -15 to +60°C (5 to 140°F),

DG..H, DG..N: -15 to +60°C (5 to 140°F),

DG..T, DG..HT, DG..NT: -40 to +60 °C (-40 to +140 °F).

Long-term use in the upper ambient temperature range accelerates the ageing of the elastomer materials and reduces the service life (please contact manufacturer).

Storage and transport temperature:

DG, DG..T: -20 to +40 °C (-4 to +104 °F).

Diaphragm pressure switch, silicone-free.

Diaphragm:

NBR for DG..U, B, N, H, I,

IIR for DG..S.

Housing: glass fibre reinforced PBT plastic with low gas release.

Lower housing section: AlSi 12.

Technical data

Enclosure: IP 54 or IP 65.

Safety class: 1.

Line diameter: 0.5 to 1.8 mm (AWG 24 to AWG 13).

Line entrance:

M16 x 1.5,

clamping range: diameters of 4 to 10 mm,

DG..T, DG..HT, DG..NT with ½" NPT conduit cable gland.

Electrical connection type:

screw terminals.

Recommended tightening torque:

Component	Tightening torque [Ncm]
Cover screws	65
M16 x 1.5 cable gland	50
Rp ½ pipe connection, aluminium	250
Rp ¼ (NPT ¼) gas connection	1300
Rp ½ air connection, switch housing	250
Clamping terminal screws	80
T15 test point screw	150

Weight: 270 to 320 g (9.5 to 11.3 oz), depending on equipment.

7.1 Adjusting range, switching hysteresis

On all DG models (except DG..N), the scale value is set to the switch-on point, and on DG..N, it is set to the switch-off point.

Type	Adjusting range*		Mean switching differential at min. and max. setting		Max. inlet pressure p_{max} = withstand pressure		Difference between switching pressure and possible reset		Deviation from the switching point during testing pursuant to EN 1854	
	mbar	"WC	mbar	"WC	mbar	psi	mbar	"WC	Gas pressure switch	Air pressure switch
DG 6.T	0.5 – 6	0.2 – 2.4	0.2 – 0.3	0.08 – 0.12	600	8.5	–	–	± 15%	± 15% or 0.04 "WC
DG 6U. DG 6B. DG 6S	0.4 – 6	–	0.2 – 0.3	–	100		–	–	± 15%	± 15% or 0.1 mbar
DG 10T		0.4 – 4		0.1 – 0.16	600	8.5			± 15%	± 15% or 0.04 "WC
DG 10U. DG 10B. DG 10S	1 – 10		0.25 – 0.4		500		–	–	± 15%	± 15%
DG 30U. DG 30B. DG 30S	2.5 – 30	–	0.35 – 0.9	–	500		–	–	± 15%	± 15%
DG 50T		1 – 20		0.3 – 0.6	600	8.5			± 15%	± 15%
DG 50U. DG 50B. DG 50S	2.5 – 50		0.8 – 1.5		500		–	–	± 15%	± 15%
DG 150U. DG 150B. DG 150S. DG 150T	30 – 150	12 – 60	3 – 5	1.2 – 2	600	8.5	–	–	± 15%	± 15%
DG 400U. DG 400B. DG 400S	50 – 400	–	5 – 15	–	600		–	–	± 15%	± 15%
DG 500U. DG 500B. DG 500S. DG 500T	100 – 500	40 – 200	8 – 17	3.2 – 6.8	600	8.5	–	–	± 15%	± 15%
DG 10H. DG 10N. DG 10HT. DG 10NT	1 – 10	0.4 – 4	–	–	600	8.5	0.4 – 1	0.16 – 0.4	± 15%	± 15%
DG 50H. DG 50N. DG 50HT. DG 50NT	2.5 – 50	1 – 20	–	–	600	8.5	1 – 2	0.4 – 0.8	± 15%	± 15%
DG 150H. DG 150N. DG 150HT. DG 150NT	30 – 150	12 – 60	–	–	600	8.5	2 – 5	0.8 – 2	± 15%	± 15%
DG 500H. DG 500N. DG 500HT. DG 500NT	100 – 500	40 – 200	–	–	600	8.5	4 – 17	1.6 – 6.8	± 15%	± 15%

* Adjusting tolerance = ± 15% of the scale value.

Technical data

Type	Adjusting range* [mbar]	Max. inlet pressure $p_{\max.}$ = withstand pressure [mbar]	Mean switching differential at min. and max. setting [mbar]	Deviation from the switching point during testing pursuant to EN 1854	
				Gas pressure switch	Air pressure switch
DG 1,5I	-1.5 to -0.5 and +0.5 to +3	± 100	0.2 – 0.5	± 15%	± 15% or 0.4 mbar
DG 12I	-12 to -1 and +1 to +7	± 100	0.5 – 1	± 15%	± 15% or 0.5 mbar
DG 18I	-2 to -18	± 100	0.5 – 1.5	± 15%	± 15% or 0.5 mbar
DG 120I	-10 to -120	± 600	4 – 11	± 15%	± 15%
DG 450I	-80 to -450	± 600	10 – 30	± 15%	± 15%

* Adjusting tolerance = ± 15% of the scale value.

7.2 Safety-specific characteristic values for DG

For SIL	
Suitable for Safety Integrity Level	SIL 1, 2, 3
Diagnostic coverage DC	0
Type of subsystem	Type A to EN 61508-2, 7.4.3.1.2
Mode of operation	High demand mode pursuant to EN 61508-4, 3.5.12
For PL	
Suitable for Performance Level	PL a, b, c, d, e
Category	B, 1, 2, 3, 4
Common cause failure CCF	> 65
Application of essential safety requirements	Satisfied
Application of tried-and-tested safety requirements	Satisfied
For SIL and PL	
	B_{10d} value
U = 24 V DC, I = 10 mA; U = 230 V AC, I = 4 mA	6,689,477 operating cycles
U = 24 V DC, I = 70 mA; U = 230 V AC, I = 20 mA	4,414,062 operating cycles
U = 230 V AC, I = 2 A	974,800 operating cycles
Hardware fault tolerance (1 component/switch) HFT	0
Hardware fault tolerance (2 components/switches, redundant operation) HFT	1
Safe failure fraction SFF	> 90%
Fraction of undetected common cause failures β	$\geq 2\%$

Max. service life under operating conditions: 10 years after date of production, plus max. ½ year in storage prior to first use, or once the given number of operating cycles has been reached, depending on which is achieved first.

The pressure switches are suitable for single-channel systems (HFT = 0) up to SIL 2/PL d, and up to SIL 3/PL e when two redundant pressure switches are installed in a double-channel architecture (HFT = 1), provided that the complete system complies with the requirements of EN 61508/ISO 13849.

For a glossary of terms, see page 30 (Glossary).

7.2.1 Determining the PFH_D value, the λ_D value and the MTTF_d value

$$PFH_D = \lambda_D \frac{1}{MTTF_d} = \frac{0.1}{B_{10d}} \times n_{op}$$

7.2.2 Calculating the PFH_D and PFD_{avg}

Switch. cap.	
n _{op}	1/h
n _{op}	1/a
Cycle time	s
B _{10d}	
T _{10d}	a
PFH _D (1 DG)	1/h
PFD _{avg} (1 DG)	
Suitable for	
PFH _D (2 DG)	1/h
PFD _{avg} (2 DG)	
Suitable for	

PFH_D = Probability of dangerous failure (HDM = high demand mode) [1/hour]

PFD_{avg} = Average probability of dangerous failure on demand (LDM = low demand mode)

λ_D = Mean dangerous failure rate [1/hour]

MTTF_d = Mean time to dangerous failure [hours]

n_{op} = Demand rate (mean number of annual operations) [1/hour]

7.3 Dimensions

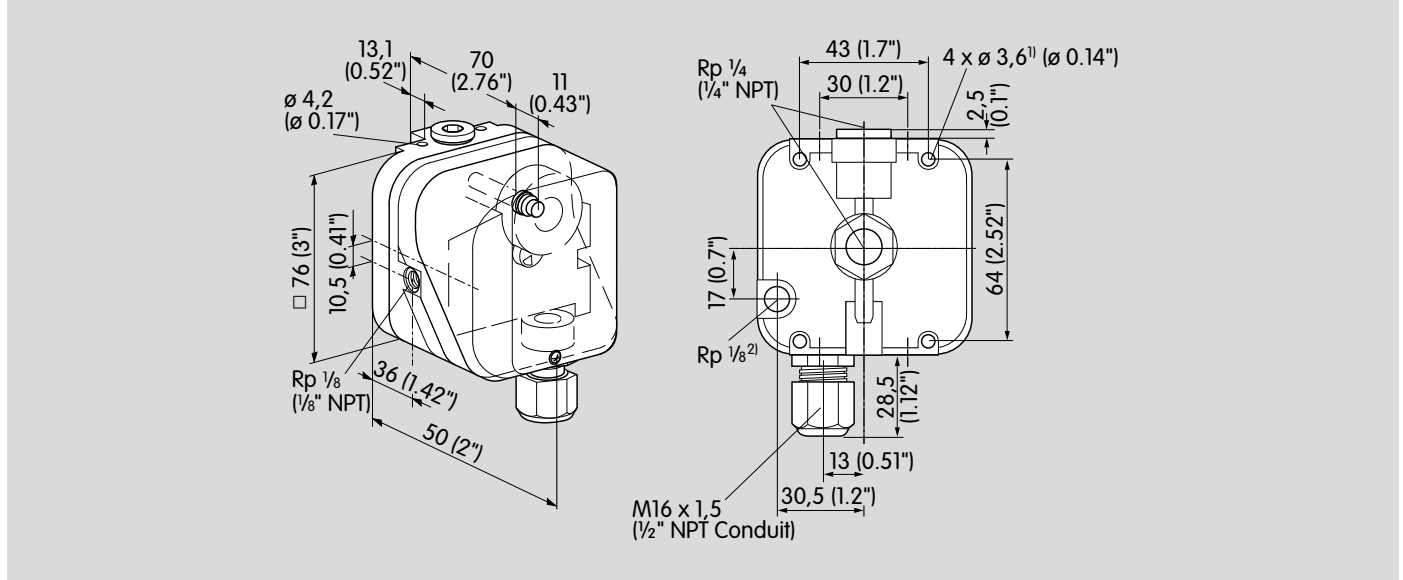

1) Holes 10 mm (0.4") deep, for self-tapping screws.

2) For DG..U, DG..H, DG..N, DG..I.

8 Maintenance cycles

At least once a year, twice a year in the case of biogas.

9 Glossary

9.1 Diagnostic coverage DC

Measure of the effectiveness of diagnostics, which may be determined as the ratio between the failure rate of detected dangerous failures and the failure rate of total dangerous failures

NOTE: Diagnostic coverage can exist for the whole or parts of a safety-related system. For example, diagnostic coverage could exist for sensors and/or logic system and/or final elements. Unit:%.

see EN ISO 13849-1

9.2 Mode of operation

High demand mode or continuous mode

Operating mode, where the frequency of demands for operation made on a safety-related system is greater than one per year or greater than twice the proof-test frequency

see EN 61508-4

9.3 Category

Classification of the safety-related parts of a control system in respect of their resistance to faults and their subsequent behaviour in the fault condition, and which is achieved by the structural arrangement of the parts, fault detection and/or by their reliability

see EN ISO 13849-1

9.4 Common cause failure CCF

Failures of different items, resulting from a single event, where these failures are not consequences of each other

see EN ISO 13849-1

9.5 Fraction of undetected common cause failures β

Fraction of undetected failures of redundant components due to a single event, whereby these failures are not based on mutual causes

NOTE: β is expressed as a fraction in the equations and as a percentage elsewhere

see EN 61508-6

9.6 B_{10d} value

Mean number of cycles until 10% of the components fail dangerously

see EN ISO 13849-1

9.7 T_{10d} value

Mean time until 10% of the components fail dangerously

see EN ISO 13849-1

9.8 Hardware fault tolerance HFT

A hardware fault tolerance of N means that $N + 1$ is the minimum number of faults that could cause a loss of the safety function

see IEC 61508-2

9.9 Mean dangerous failure rate λ_D

Mean rate of dangerous failures during operation time (T_{10d}). Unit: 1/h.

see EN ISO 13849-1

9.10 Safe failure fraction SFF

Fraction of safe failures related to all failures, which are assumed to appear

see EN 13611/A2

9.11 Probability of dangerous failure PFH_D

Value describing the likelihood of dangerous failure per hour of a component for high demand mode or continuous mode. Unit: 1/h.

see EN 13611/A2

9.12 Mean time to dangerous failure $MTTF_d$

Expectation of the mean time to dangerous failure

see EN ISO 13849-1

9.13 Demand rate n_{op}

Mean number of annual operations

from EN ISO 13849-1

9.14 Average probability of dangerous failure on demand PFD_{avg}

(LDM = 1 – 10 switching cycles/year)

Average probability of a dangerous failure of the safety function on demand (LDM = low demand mode)

see EN 61508-6

Feedback

Finally, we are offering you the opportunity to assess this “Technical Information (TI)” and to give us your opinion, so that we can improve our documents further and suit them to your needs.

Clarity

- Found information quickly
- Searched for a long time
- Didn't find information
- What is missing?
- No answer

Comprehension

- Coherent
- Too complicated
- No answer

Scope

- Too little
- Sufficient
- Too wide
- No answer



Use

- To get to know the product
- To choose a product
- Planning
- To look for information

Navigation

- I can find my way around
- I got “lost”
- No answer

My scope of functions

- Technical department
- Sales
- No answer

Remarks

Contact

Elster GmbH
Postfach 2809 · 49018 Osnabrück
Strothweg 1 · 49504 Lotte (Büren)
Germany

Tel. +49 541 1214-0
Fax +49 541 1214-370
info@kromschroeder.com
www.kromschroeder.com

The current addresses of our international agents are available on the Internet:
www.kromschroeder.de/Weltweit.20.0.html?&L=1

We reserve the right to make technical modifications in the interests of progress.
Copyright © 2017 Elster GmbH
All rights reserved.

