Bulletin 1492 Line Control Circuit and Load Protection Devices

Page 4-2



Bulletin 1492-FB Fuse Holders

Page 4-4



Bulletin 1492-CB Manual Motor Controller/Supplementary Protector/Miniature Circuit Breaker

Page 4-5



Bulletin 1492-GH/GS Supplementary Protector (Miniature Circuit Breakers)

Page 4-11



Bulletin 1492-SP Supplementary Protector/Miniature Circuit Breaker

Page 4-14



Bulletin 1492-SPU Circuit Breaker with UL 489 Approval

Page 4-21

Bulletin 1492 Line

Control Circuit and Load Protection Devices

Product Overview

Allen-Bradley offers a line of Miniature Circuit Breakers with UL489 (CSA 22.2 #5.1) approval, three different lines of Supplementary Protectors (Miniature Circuit Breakers), and a line of fuse holders for branch circuit fuses and supplementary fuses.

Product Selection

Bulletin 1492-FB Fuse Holders

1492- Fuse Holders provide a DIN Rail-mounted package for use in Class CC, Class J, and Midget fuse applications such as protection of transformers and motors.

Features include:

- EN/IEC 60529 finger protection — dead front construction
- Compact size requiring less panel space than open-style fuse holders
- Optional blown fuse indicator
- Branch circuit protection with Class CC and J fuses
- UL Listed, CSA Certified
- DIN Rail (35 mm), mounted

Bulletin 1492 Circuit Breakers

Allen-Bradley Thermal Magnetic Miniature Circuit Breakers are ideal for protecting control circuitry and load components from damage due to overcurrents and short circuits.

Potential applications include protection of:

- Solenoids
- Transformers
- Computers
- Power Supplies
- Relay/contactor coils
- PLCs
- Medical Equipment
- PLC I/O Points

UL1077, CSA C22.2 No.235 — In North America, miniature circuit breakers are recognized as supplementary protectors and are intended for use as overcurrent protection within an appliance or

UL1077, CSA C22.2 No. 235 — In North America, miniature circuit breakers are recognized as supplementary protectors and are intended for use as overcurrent protection within an appliance or other electrical equipment where branch circuit protection is already provided or not required. Internationally, these products are rated to IEC standards as miniature circuit breakers or circuit breakers for equipment.

UL508, CSA 22.2 No.14 — In North America, some miniature circuit breakers, meeting specific requirements, may be used as Manual Motor Controllers for direct control of motors connected across-the-line equipment where branch circuit protection is already provided or not required. Internationally, these products are rated to IEC standards as miniature circuit breakers and applied for motor controller applications within those standards.

UL489, CSA 22.2 No. 5.1 — In North America, some miniature circuit breakers, meeting specific requirements, may be used as Branch Circuit Protection devices for the protection of electric wiring as well as load protection.

Type	1492-CB	1492-GH	1492-GS	1492-SP	1492-SPU	
Certifications	UL	508 & 1077	1077	1077	489	
	CSA	22.2 No. 14 & 235	22.2 No. 235	22.2 No. 235	22.2 # 5.1	
	EN/IEC	60934	60934	60934	60898 60947-2	—
	CE Marked	Yes	Yes	Yes	Yes	—
No. of Poles	1,2,3 – 1+N, 3+N	1	1,2,3	1,2,3 – 1+N, 3+N	1	
Volts AC	480Y/277 V	250 V	480Y/277 V	480Y/277 V	240 V	
Volts DC	65 V DC version — 1p-120V 2p (series) 240V	65 V	65 V	1p 48V 2p (series) 125V	—	
Current Range	0.5...52A	0.2...15A	0.2...25A	0.5...63A	0.5...20A	
Hp Rating	1/10...40 Hp	—	—	—	—	
Trip Characteristics (In)	F 3...5 G 6...10 H 12...20	G 6...12	G 6...10	B 3...5 C 5...10 D 10...20	B 3...5 C 5...10 D 10...20	
Energy Limiting	Yes	No	No	Yes	—	
No. of Pole/foot	17	24	24	17	17	
Mounting Method	DIN Rail	DIN Rail & A-B Rail	DIN Rail & A-B Rail	DIN Rail	DIN Rail	
IEC 529 and 60947 Finger Protection	Yes	Yes	Yes	Yes	Yes	
Optional	Auxiliary Contacts	Yes	No	Yes	Yes	Consult Factory
	Shunt Trip	Yes	No	No	Yes	Consult Factory
	Undervoltage Trip	No	No	No	Yes	Consult Factory

Technical Information: The Benefits of Limiting Let-Through Energy

Energy Limiting Circuit Breakers Versus Conventional Breakers

The Bulletin 1492-CB and 1492-SP lines feature the unique ability to achieve short circuit interruptions far more effectively than conventional circuit breakers. In *conventional circuit breakers*, the short circuit interruption time required is approximately one or two half cycles of an AC sine wave. When the contacts open, the resulting arc continues to burn until the current level passes through zero. The arc may re-ignite because of the insufficient width of the contact gap. The current that flows until the arc is extinguished produces a heating effect proportional to the I^2t value (*let-through-energy*) of the fault current.

These devices are designed to substantially reduce the amount of *let-through-current* and the resulting *let-through-energy* that can damage protected components. They have the ability to interrupt short circuit current **within the first half cycle** of the fault. Limiting let-through-energy will protect against the harmful effects of over-current and is focused primarily on avoiding the following:

- Excessive Heat
- Mechanical Damage

Both of these factors are proportional to the square of the current. Thermal energy is proportional to the square of the RMS value and magnetic forces are proportional to the square of the peak value. The most effective way to provide protection is to substantially limit *let-through-energy*. This provides the following advantages:

- Far less damage at the location of the short circuit.
- Fast electric separation of a faulty unit from the system, especially power supplies connected in parallel that are switched off when the voltage of the power bus drops below a certain level.
- Far less wear on the miniature circuit breaker itself. This means more safe interruptions.
- Better protection of all components in the short circuit path.
- Far wider range of selective action when used with an upstream protective device. (No nuisance shut downs from feeder line interruptions causing a blackout in all connected branches.)

Short Circuit Interruption 10 kA — 120V AC
Instant of initiation: 15° after voltage zero

CONVENTIONAL BREAKERS ALLEN-BRADLEY Bulletin 1492-SP

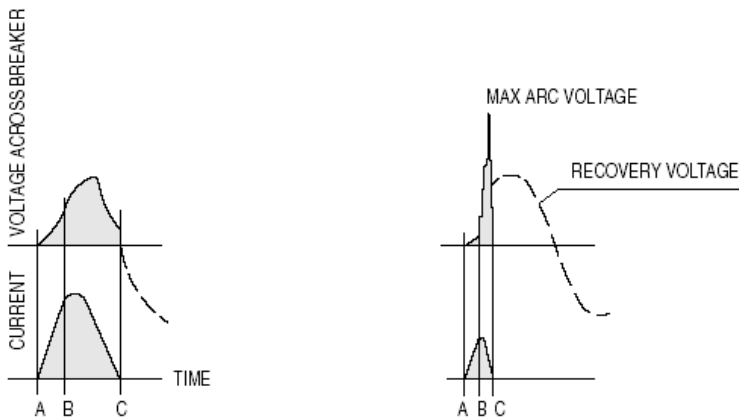

A = Instant when the short is initiated
 B = Instant when the contacts open and the arc is initiated
 C = Instant when the arc extinguishes and the current ceases to flow

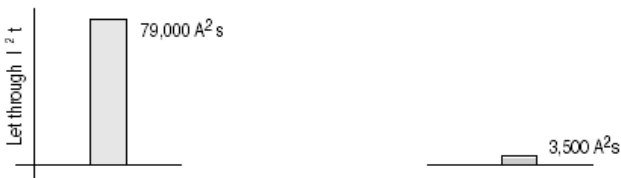

DIN Rail Mounting Fuse Holders

Product Overview/Specifications



Bulletin 1492-FB — DIN Rail Mounting Fuse Holders

- EN/IEC 60529 Finger Protection — Dead Front Construction
- The Patented Handle Design Isolates the Fuse from Power When Handle is Opened for Fuse Insertion or Removal
- Compact Size Requiring Less Panel Space than Open-style Fuse Holders
- Optional Blown Fuse Indicators — Allow for Easy Troubleshooting of Electrical Circuits
- Easy Insertion/Removal of Fuses, No Special Tools Required
- Rejection Feature in Type CC and Type J Fuse Holders
- Mounts on Standard 35 mm DIN Rail (A-B p/n 199-DR1)

Table of Contents

Product Selection . . . 4-5
 Approximate Dimensions 4-5

Standards Compliance

- CE Marked
- CSA 22.2 No. 39 UL 512 (J and CC)
- EN/IEC 60947-7-1
- EN/IEC 60529 finger protection – dead front construction

Bulletin 1492-FB Class CC, J, and Midget fuse holders provide a safe and convenient means for the installation of the noted fuses. These fuse holders are available with or without blown fuse indication for easily integrated overcurrent protection. The housing package isolates the fuse from the circuit when installing and removing fuses.

Class CC and J holders are UL listed for branch circuit protection in electrical distribution systems. They are excellent for small motor loads and for group protection of small motors. Midget holders are UL recognized. The Bulletin 1492-FB fuse holder family is designed for use in many applications such as protection of power supplies, primary and secondary control transformers, solenoids, lighting and heater loads, drives, and other equipment protection. The Bulletin 1492-FB provides IP2 dead-front construction and is designed to be IEC 529 finger-safe. The handle isolates the fuse from the line power each time the handle is opened for fuse removal and insertion.

These fuse holders accept fuses by simply sliding the fuse into the holder without the need of special tools. The fuse holders have backed-out screws for installation and mount easily on #3 DIN Rail (35 mm). The Class CC is designed to reject midget fuses or international 10 x 38 mm fuses. The Type J will reject all fuses other than Class J fuses.

The compact size of the Bulletin 1492-FB fuse holders features a small footprint, requiring less panel space than open-style fuse holders.

Specifications

	For Class CC Fuse		For Class J Fuse		For Midget Fuse
	30 A		30 A	60 A	30 A
Certifications	ULus, CSA				URus, CSA
Maximum Voltage Rating	600V AC/DC				
Fuse Withstand Rating	200 kA				100 kA
Fuse Reject Feature	Yes		Yes		No
Insulation Temperature Range	-40...+295 °F (-40...+140 °C)				
Housing Material	UL 94V-O				
With Indicator	Working Voltage	Neon	95...600V AC, 115...660V DC		
	Working Voltage	LED	12...14V DC or 35...48V DC		
	Leakage Current	Neon	0.8 ma Max @ 600V		
	Leakage Current	LED	10 ma @ 24V DC or 48V DC		
Wire Size	#14...6 AWG Cu		#14...2 AWG Cu		#14...6 AWG Cu
Recommended Wire Strip Length	0.5 in (12.5 mm)				
Terminal Torque	1.7 N•m (15 lb•in)		3.9 N•m (35 lb•in)	5.0 N•m (45 lb•in)	1.7 N•m (15 lb•in)

Product Selection

Description	For Class CC Fuse	For Class J Fuse		For Midget Fuse
	30 A*	30 A	60 A	30 A
	Cat. No.	Cat. No.	Cat. No.	Cat. No.
One-Pole				
Without Blown Fuse Indicator	1492-FB1C30	1492-FB1C30	1492-FB1J60	1492-FB1M30
With Blown Fuse Indicator (neon)	1492-FB1C30-L	1492-FB1J30-L	1492-FB1J60-L	1492-FB1M30-L
With Blown Fuse Indicator (LED) 24V DC	1492-FB1C30-D1	—	—	1492-FB1M30-D1
With Blown Fuse Indicator (LED) 48V DC	1492-FB1C30-D2	—	—	1492-FB1M30-D2
Pieces per Carton	6			
Two-Pole				
Without Blown Fuse Indicator	1492-FB2C30	1492-FB2J30	1492-FB2J60	1492-FB2M30
With Blown Fuse Indicator (neon)	1492-FB2C30-L	1492-FB2J30-L	1492-FB2J60-L	1492-FB2M30-L
Pieces per Carton	3			
Three-Pole				
Without Blown Fuse Indicator	1492-FB3C30	1492-FB3J30	1492-FB3J60	1492-FB3M30
With Blown Fuse Indicator (neon)	1492-FB3C30-L	1492-FB3J30-L	1492-FB3J60-L	1492-FB3M30-L
Pieces per Carton	2			

* All major fuse brands and current ranges have been evaluated for this fuse holder. Due to the heat they generate, the following fuses must be derated:
 Ferraz Shamut ATQR 1.25 I = 0.42 A max.
 Ferraz Shamut ATQR 1.40 I = 0.47 A max.

Approximate Dimensions

Dimensions are in inches (millimeters). Dimensions are not intended to be used for manufacturing purposes.



Dimension	For Class CC Fuse	For Class J Fuse		For Midget Fuse
	30 A	30 A	60 A	30 A
Height	3.07 in (78 mm)	4.49 in (114 mm)	4.8 in (122 mm)	3.07 in (78 mm)
Depth	2.13 in (54 mm)	2.20 in (56 mm)	2.44 in (62 mm)	2.13 in (54 mm)
Width	One-Pole	0.69 in (17.5 mm)	1.28 in (32.5 mm)	1.57 in (40 mm)
	Two-Pole	1.38 in (35 mm)	2.56 in (65 mm)	3.15 in (80 mm)
	Three-Pole	2.07 in (52.5 mm)	3.84 in (97.5 mm)	4.72 in (120 mm)



Bulletin 1492-CB — Manual Motor Controller/Supplementary Protector/Miniature Circuit Breaker

- Both a Manual Motor Controller and a Supplementary Protector in one Convenient Package (Series C Devices)
- Suitable for use as Motor Disconnect (0.5...30 A)
- AC and DC Voltage Ratings — in One Convenient Device
- Higher Voltage DC Rating in Similar Package (DF, DG, DH)
- Energy Limiting Design — Protects Downstream Components Better than Conventional Breakers During Short Circuits
- Field-Mountable Options for Selective Applications
- True IP2X Finger-Safe Design (Top and Sides)
- International Approvals — CE Marked, and Meets UL, CSA, and IEC (VDE) Standards for Worldwide Acceptance
- Ratings to 480Y/277V AC @ 125V AC — 10 000 A U2 Interrupting Capability
- A Positively Trip-Free Mechanism (Breaker Operation Cannot be Defeated by Holding the Handle in the ON Position)
- Three Trip Curves: F, G, and H

Table of Contents

- Product Selection ... 4-7
- Specifications 4-10
- Approximate Dimensions 4-10

Standards Compliance

- UL 508, 1077
- CSA 22.2 No. 14, 235
- IEC/EN 60950, 60934
- VDE 0641, 0660

Bulletin 1492-CB Series C devices may be applied as manual motor controllers for direct control of motors connected across-the-line, meeting UL 508/CSA 22.2 No 14. Additionally, these devices are intended for use as a motor disconnect * and can be locked in the OFF position when used with the locking device kit. These devices are provided with an internal, nonreplaceable, fixed thermal (bimetal type) overload trip feature and instantaneous magnetic trip feature designed to trip open the controller main contacts upon overcurrent. They are suitable for providing motor overload protection.

These devices may be applied in Group Motor applications. These devices are also rated as a controller and disconnect for AC general use loads and AC resistive (heating) loads.

The Bulletin 1492-CB supplementary protectors/miniature circuit breakers are available in one-, one-pole plus neutral, two-, three-, and three-pole plus neutral units. One- and two-pole AC units also have limited DC ratings. Two and three-pole units are connected at the handle for simultaneous operation. In addition, the product line includes devices that are specifically rated for DC with trip curves, DF, DG and DH. Screw termination is standard on all Bulletin 1492-CB units. Both line and load side terminals accept #16...4 AWG (1.5...25 mm²) copper wire.

Bulletin 1492-CB series B and series C are “energy limiting” thermal magnetic type overcurrent protectors meeting UL 1077/CSA 22.2 No. 235, IEC/EN 60934. These devices are designed for the protection of a wide variety of products including:

- Solenoids
- Test Equipment
- Controller I/O Points
- Relay and Contactor Coils
- Computers
- Transformers
- Automotive Systems
- Power Supplies
- Medical Equipment
- Control Instrumentation

Bulletin 1492-CB supplementary protectors/miniature circuit breakers are designed to comply with standards for world-wide customer acceptance. They meet the following standards:

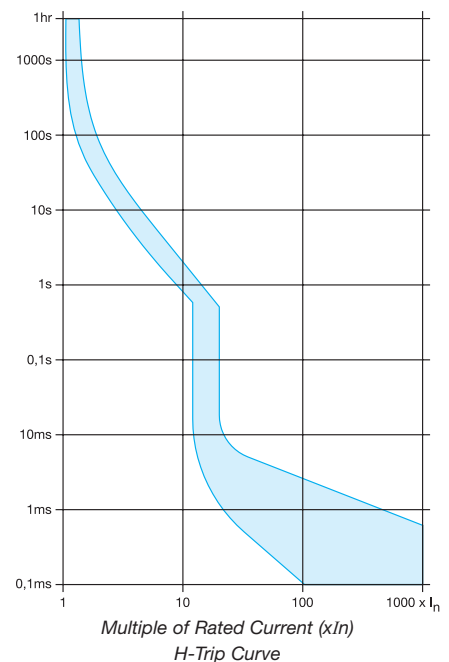
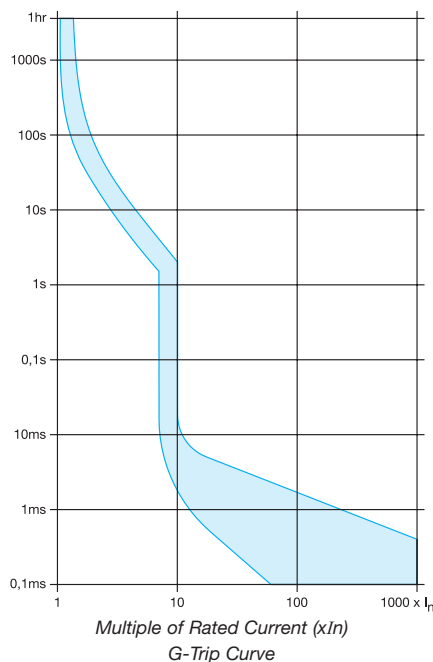
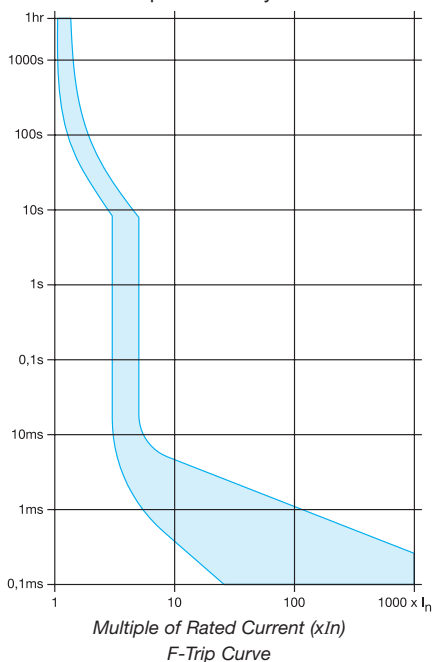

Manual Motor Controller/Supplementary Protector/Miniature Circuit Breaker

Product Selection

Product Selection

Note: Bulletin 1492-CB Circuit Breakers are also available with neutral (1-pole and 3-pole). Devices with Neutral are rated as Supplementary Protectors only, with a Component Recognition. Add a suffix of -N to cat. no.

Number of Poles	Tripping Characteristic		F Trip Resistive or Slightly Inductive	G Trip Inductive	H Trip Highly Inductive
	Continuous Current Rating (In) Ampere	Maximum Hp 1p @ 277V AC, 1-phase 2p @ 480V AC, 1-phase 3p @ 480V AC, 3-phase	3...5 /n	6...10 /n	12...20 /n
			Cat. No.	Cat. No.	Cat. No.
1-Pole 1 Piece per Carton	0.5	—	1492-CB1F005	1492-CB1G005	1492-CB1H005
	1	—	1492-CB1F010	1492-CB1G010	1492-CB1H010
	1.5	1/10	1492-CB1F015	1492-CB1G015	1492-CB1H015
	2	1/6	1492-CB1F020	1492-CB1G020	1492-CB1H020
	3	1/3	1492-CB1F030	1492-CB1G030	1492-CB1H030
	4	1/3	1492-CB1F040	1492-CB1G040	1492-CB1H040
	5	1/2	1492-CB1F050	1492-CB1G050	1492-CB1H050
	6	3/4	1492-CB1F060	1492-CB1G060	1492-CB1H060
	7	1	1492-CB1F070	1492-CB1G070	1492-CB1H070
	8	1	1492-CB1F080	1492-CB1G080	1492-CB1H080
	10	2	1492-CB1F100	1492-CB1G100	1492-CB1H100
	12	2	1492-CB1F120	1492-CB1G120	1492-CB1H120
	15	3	1492-CB1F150	1492-CB1G150	1492-CB1H150
	16	3	1492-CB1F160	1492-CB1G160	1492-CB1H160
	20	3	1492-CB1F200	1492-CB1G200	1492-CB1H200
	25	5	1492-CB1F250	1492-CB1G250	1492-CB1H250
	30	5	1492-CB1F300	1492-CB1G300	1492-CB1H300
	32	5	1492-CB1F320	1492-CB1G320	1492-CB1H320
	40	7.5	1492-CB1F400	1492-CB1G400	1492-CB1H400
	50	10	1492-CB1F500	1492-CB1G500	1492-CB1H500
52	10	1492-CB1F520	1492-CB1G520	1492-CB1H520	
2-Pole 1 Piece per Carton	0.5	—	1492-CB2F005	1492-CB2G005	1492-CB2H005
	1	—	1492-CB2F010	1492-CB2G010	1492-CB2H010
	1.5	—	1492-CB2F015	1492-CB2G015	1492-CB2H015
	2	—	1492-CB2F020	1492-CB2G020	1492-CB2H020
	3	1/2	1492-CB2F030	1492-CB2G030	1492-CB2H030
	4	1	1492-CB2F040	1492-CB2G040	1492-CB2H040
	5	1.5	1492-CB2F050	1492-CB2G050	1492-CB2H050
	6	2	1492-CB2F060	1492-CB2G060	1492-CB2H060
	7	2	1492-CB2F070	1492-CB2G070	1492-CB2H070
	8	2	1492-CB2F080	1492-CB2G080	1492-CB2H080
	10	3	1492-CB2F100	1492-CB2G100	1492-CB2H100
	12	3	1492-CB2F120	1492-CB2G120	1492-CB2H120
	15	5	1492-CB2F150	1492-CB2G150	1492-CB2H150
	16	5	1492-CB2F160	1492-CB2G160	1492-CB2H160
	20	5	1492-CB2F200	1492-CB2G200	1492-CB2H200
	25	7.5	1492-CB2F250	1492-CB2G250	1492-CB2H250
	30	10	1492-CB2F300	1492-CB2G300	1492-CB2H300
	32	10	1492-CB2F320	1492-CB2G320	1492-CB2H320
	40	15	1492-CB2F400	1492-CB2G400	1492-CB2H400
	50	20	1492-CB2F500	1492-CB2G500	1492-CB2H500
52	20	1492-CB2F520	1492-CB2G520	1492-CB2H520	



Manual Motor Controller/Supplementary Protector/Miniature Circuit Breaker

Product Selection

Tripping Characteristic			F Trip Resistive or Slightly Inductive	G Trip Inductive	H Trip Highly Inductive
			3...5 I _n	6...10 I _n	12...20 I _n
Number of Poles	Continuous Current Rating (I _n) Ampere	Maximum Hp 1p @ 277V AC, 1-phase 2p @ 480V AC, 1-phase 3p @ 480V AC, 3-phase	Cat. No.	Cat. No.	Cat. No.
3-Pole 1 Piece per Carton	0.5	—	1492-CB3F005	1492-CB3G005	1492-CB3H005
	1	—	1492-CB3F010	1492-CB3G010	1492-CB3H010
	1.5	1/2	1492-CB3F015	1492-CB3G015	1492-CB3H015
	2	3	1492-CB3F020	1492-CB3G020	1492-CB3H020
	3	1.5	1492-CB3F030	1492-CB3G030	1492-CB3H030
	4	2	1492-CB3F040	1492-CB3G040	1492-CB3H040
	5	3	1492-CB3F050	1492-CB3G050	1492-CB3H050
	6	3	1492-CB3F060	1492-CB3G060	1492-CB3H060
	7	3	1492-CB3F070	1492-CB3G070	1492-CB3H070
	8	5	1492-CB3F080	1492-CB3G080	1492-CB3H080
	10	5	1492-CB3F100	1492-CB3G100	1492-CB3H100
	12	7.5	1492-CB3F120	1492-CB3G120	1492-CB3H120
	15	10	1492-CB3F150	1492-CB3G150	1492-CB3H150
	16	10	1492-CB3F160	1492-CB3G160	1492-CB3H160
	20	10	1492-CB3F200	1492-CB3G200	1492-CB3H200
	25	15	1492-CB3F250	1492-CB3G250	1492-CB3H250
	30	20	1492-CB3F300	1492-CB3G300	1492-CB3H300
	32	20	1492-CB3F320	1492-CB3G320	1492-CB3H320
	40	30	1492-CB3F400	1492-CB3G400	1492-CB3H400
50	30	1492-CB3F500	1492-CB3G500	1492-CB3H500	
52	40	1492-CB3F520	1492-CB3G520	1492-CB3H520	



Note: 1492-CB Circuit Breakers are also available with neutral (1-pole and 3-pole). Devices with neutral are rated as Supplementary Protectors only with a Component Recognition. Add a suffix of -N to catalog number.

Note: Bulletin 1492-CB Circuit Breakers are also available with specific DC ratings (1- and 2-pole). DC specific rated devices are available as Supplementary Protectors only, with Component Recognition.

Tripping Characteristic		DF Trip Resistive or Slightly Inductive	DG Trip Inductive	DH Trip Highly Inductive
		4.5...8 I _n	9...16 I _n	18...32 I _n
Number of Poles	Continuous Current Rating (I _n) Ampere	Cat. No.	Cat. No.	Cat. No.
2-Pole 1 Piece per Carton	0.5	1492-CB2DF005	1492-CB2DG005	—
	1	1492-CB2DF010	1492-CB2DG010	—
	2	1492-CB2DF020	1492-CB2DG020	—
	3	1492-CB2DF030	1492-CB2DG030	—
	4	1492-CB2DF040	1492-CB2DG040	—
	5	1492-CB2DF050	1492-CB2DG050	—
	6	1492-CB2DF060	1492-CB2DG060	1492-CB2DH060
	7	1492-CB2DF070	1492-CB2DG070	1492-CB2DH070
	8	1492-CB2DF080	1492-CB2DG080	1492-CB2DH080
	10	1492-CB2DF100	1492-CB2DG100	1492-CB2DH100
	12	1492-CB2DF120	1492-CB2DG120	1492-CB2DH120
	15	1492-CB2DF150	1492-CB2DG150	1492-CB2DH150
	16	1492-CB2DF160	1492-CB2DG160	1492-CB2DH160
	20	1492-CB2DF200	1492-CB2DG200	1492-CB2DH200
	25	1492-CB2DF250	1492-CB2DG250	1492-CB2DH250
	30	1492-CB2DF300	1492-CB2DG300	1492-CB2DH300
32	1492-CB2DF320	1492-CB2DG320	1492-CB2DH320	
40	1492-CB2DF400	1492-CB2DG400	1492-CB2DH400	

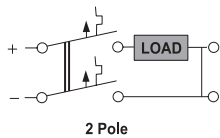

Manual Motor Controller/Supplementary Protector/Miniature Circuit Breaker

Product Selection, Continued

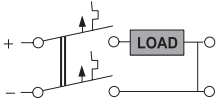
Tripping Characteristic		DF Trip Resistive or Slightly Inductive	DG Trip Inductive	DH Trip Highly Inductive
		4.5...8 /n	9...16 /n	18...32 /n
Number of Poles	Continuous Current Rating (In) Ampere	Cat. No.	Cat. No.	Cat. No.
2-Pole 1 Piece per Carton   2 Pole	0.5	1492-CB2DF005	1492-CB2DG005	—
	1	1492-CB2DF010	1492-CB2DG010	—
	2	1492-CB2DF020	1492-CB2DG020	—
	3	1492-CB2DF030	1492-CB2DG030	—
	4	1492-CB2DF040	1492-CB2DG040	—
	5	1492-CB2DF050	1492-CB2DG050	—
	6	1492-CB2DF060	1492-CB2DG060	1492-CB2DH060
	7	1492-CB2DF070	1492-CB2DG070	1492-CB2DH070
	8	1492-CB2DF080	1492-CB2DG080	1492-CB2DH080
	10	1492-CB2DF100	1492-CB2DG100	1492-CB2DH100
	12	1492-CB2DF120	1492-CB2DG120	1492-CB2DH120
	15	1492-CB2DF150	1492-CB2DG150	1492-CB2DH150
	16	1492-CB2DF160	1492-CB2DG160	1492-CB2DH160
	20	1492-CB2DF200	1492-CB2DG200	1492-CB2DH200
	25	1492-CB2DF250	1492-CB2DG250	1492-CB2DH250
	30	1492-CB2DF300	1492-CB2DG300	1492-CB2DH300
32	1492-CB2DF320	1492-CB2DG320	1492-CB2DH320	
40	1492-CB2DF400	1492-CB2DG400	1492-CB2DH400	

Additional Devices

Description		Cat. No.
Auxiliary Contacts	Auxiliary Contact Module Switches when protective device is operated manually or tripped electrically 1 N.O. Contact	1492-ACBH1
	Auxiliary Contact Module Switches when protective device is operated manually or tripped electrically 1 N.C. Contact	1492-ACBH2
	Signal Alarm Contact Module Trip indicating contact switches only when the protective device is tripped electrically 1 N.O. Contact	1492-ACBS1
	Signal Alarm Contact Module Trip indicating contact switches only when the protective device is tripped electrically 1 N.C. Contact	1492-ACBS2
Shunt Trip Module	Shunt Trip Module Use the Shunt Trip Module to trip the adjacent breaker poles from a remote location. The module is actuated by applying a voltage (pick-up voltage) to the trip terminals. • Shunt Trip Modules are often used in emergency shutdown circuits where multiple power circuits must be switched off from a single location.	5...12V AC/DC 10...24V AC/DC 20...48V AC/DC 40...110V AC/DC 90...240V AC/DC
		1492-ACBA1
		1492-ACBA2
		1492-ACBA3
		1492-ACBA4 1492-ACBA5
	Pieces Per Package	Cat. No.
DIN (#3) Symmetrical Rail 35 mm x 7.5 mm x 1 m long Zinc-plated, yellow chromated EN 50022	5	199-DR1
End Anchor	10	1492-EAHJ35
Lockout Attachment	5	1492-ACBLOA
Bus Bars	See page 4-18 for Pin Style Bus Bars	

Manual Motor Controller/Supplementary Protector/Miniature Circuit Breaker Specifications/Approximate Dimensions

	F Curve Resistive or Slightly Inductive Loads	G Curve Slightly Inductive Loads	D Curve Highly Inductive Loads
Tripping Characteristic	3...5 I _n	6...10 I _n	12...20 I _n
Dielectric Strength	1960V AC		
Shock	25 G Half Sine Wave for 11 ms (3 Axis)		
Vibration	Frequency Range: 10...500 Hz Max. Amplitude (p - p) = 0.030in Max. Acceleration = 5 G 1 hour each of 3 axis		
Operating Temperature Range	-40...+140 °F (-20...+60 °C) non-condensing		
Shipment and Short Term Temperature Limits	-40...+185 °F (-20...+85 °C)		
Housing Material	Melamine-Phenolic		
Wire Size	#16...4 AWG (1.0...25 mm ²)		
Recommended Wire Strip Length	0.51 in (13 mm)		
Electromechanical Life at 240V AC	Up to 6 A, 50 000 cycles 7...16 A, 30 000 cycles 20...32 A, 20 000 cycles 40...50 A, 12 000 cycles		
Switched Neutral Rating	277V AC, 65 A		
Auxiliary Contact Rating	277V AC, 6A		
Signal Contact Rating	125V AC, 1A 50V DC, 6A		
Manual Motor Controller (Series C Devices) (Hp rated, Overload Protection, Instantaneous Trip Provided) Suitable as Motor Disconnect* Suitable for Single Motor and Group Motor Applications			
Current Range	1...52 A	0.5...52 A	0.5...52 A
Short Circuit Rating/Interrupting Capability without Series Fuse†			
One-Pole	5 kA @ 277V AC		
Multi-Pole	5 kA @ 480YV AC		
Supplementary Protector — General Industrial Type 25 °C Ambient			
Current Range	1...52A	0.5...52A	0.5...52A
Overload Rating (OL), Tested at 1.5 Times Current Rating for General Use			
One-Pole	OL: 0 @ 277V AC		
Multi-Pole	OL: 0 @ 480Y/277V AC		

* (0.5...30 A)

† Suitable for use after clearing fault.

Approximate Dimensions

Dimensions are shown in inches (millimeters). Dimensions are not intended for manufacturing purposes.

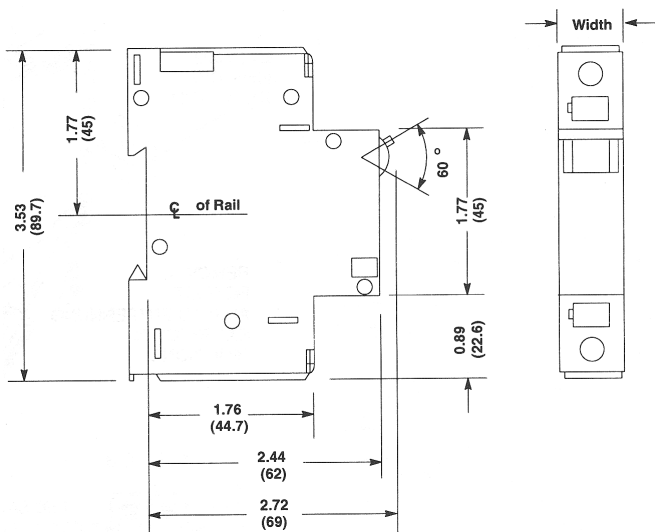

	F Curve Resistive or Slightly Inductive Loads	G Curve Slightly Inductive Loads	D Curve Highly Inductive Loads
Tripping Current (TC)*			
TC: 1	Tripping Current is in the range of 125...135% of amp range		
Short Circuit/Interrupting Capability Rating without Series Fuse			
One-Pole	5 kA @ 277V AC U1 3 kA @ 277V AC U2 and U3 10 kA @ 125V AC U2 and U3		
Multi-Pole	5 kA @ 480Y/277V AC U1 3 kA @ 480Y/277V AC U2 and U3 10 kA @ 240V AC U2 5 kA @ 240V AC U3		
One-Pole, Two-Pole	2 kA @ 65V DC U1		
DC Rated Devices	DF Curve 4.5...8 I _n	DG Curve 9...16 I _n	DH Curve 18...32 I _n
One-Pole	10 kA @ 120V DC U1	10 kA @ 120V DC U1	5kA @ 120V DC U1
Two-Pole in Series	10 kA @ 240V DC U1	10 kA @ 240V DC U1	5kA @ 240V DC U1
Miniature Circuit Breaker (IEC) Interrupt Rating			
Current Range	1...50 A	0.5...50 A	0.5...50 A
One-Pole	10 kA @ 240V AC		
Multi-Pole	10 kA @ 420V AC		

* (0.5...30 A)

Number of Poles and Accessories	1	2	3	4	5
Width (inches)	0.7	1.4	2.1	2.8	3.5
Width (millimeters)	17.8	35.6	53.3	71.1	88.9

Note: Accessories and one pole width are identical.

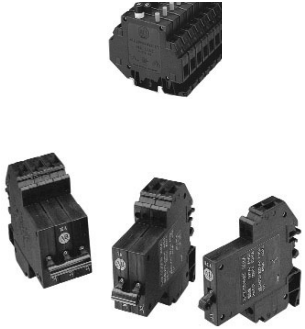
	<p>Bulletin 1492-GH and 1492-GS — Supplementary Protectors (Miniature Circuit Breakers)</p> <ul style="list-style-type: none"> • High density design allows 24 one-pole breakers per foot • Wide range of currents for precise circuit requirements • International approvals — meet UL, CSA, and IEC standards for worldwide acceptance • CE Marked • AC and DC voltage ratings — in one convenient device • A positively trip free mechanism (breaker operation cannot be defeated by holding the handle in the ON position) • Superior shock and vibration resistance capabilities — helps prevent nuisance tripping • Universal mounting foot for a variety of mounting channels, including Cat. No. 1492-N1 and various 35 mm DIN (e.g., Cat. No. 199-DR1) 	<p>Table of Contents</p> <p>Product Selection . . . 4-12 Approximate Dimensions 4-13</p> <p>Standards Compliance</p> <ul style="list-style-type: none"> • UL 1077 • CSA 22.2 No 235 • EN/IEC 60934 • CE Marked
---	--	---

Bulletin 1492 High Density miniature circuit breakers are thermal magnetic type supplementary overcurrent protective devices. Bulletin 1492-GH miniature circuit breakers are available in one-pole units. Bulletin 1492-GS are available in one-, two-, and three-pole. These breakers are often used when panel space (width) is a premium. These products include a high density design. Up to 24 one-pole breakers can be mounted per foot. The Bulletin 1492-GS breaker can be ordered with auxiliary contacts that do not add any additional space. Wire termination is achieved by a clamping style, self-lifting box lug.

One-Pole Style Bulletin 1492-GH

Single-pole, high-density miniature circuit breaker that incorporates a thermal portion and a magnetic trip function for the combined advantages of two sensing systems. The Bulletin 1492-GH style of breakers uses a push-to-set mechanism for circuit actuation and comes with a manual trip button for manually opening the circuit. Voltage range is 250V AC, and this breaker has a 65V DC rating.

One-, Two-, and Three-Pole Style Bulletin 1492-GS

These high-density miniature circuit breakers incorporate a thermal portion and a magnetic trip function for the combined advantages of two sensing systems. The Bulletin 1492-GS style of breakers uses a toggle style handle mechanism for circuit actuation. Voltage range is 277V AC for the one-pole and 480Y/277V AC for the multiple pole. These breakers have a 65V DC rating.

Applications

Included, but not limited to, the protection of test equipment, control instrumentation, solenoids, and power supplies. The wide range of current values and the use of a thermal magnetic trip system allows for a variety of applications where a very accurate and compact breaker is required.

UL1077, CSA C22.2 #235

In North America, miniature circuit breakers are recognized as supplementary protectors and are intended for use as overcurrent protection within an appliance or other electrical equipment where branch circuit protection is already provided or not required. Internationally, these products are rated to IEC standards as circuit breakers for equipment (CBE).

Specifications

	1492-GH		1492-GS		
	1-pole		1-pole	2-pole	3-pole
Maximum Interrupting Capacity					
UL/CSA	200 A (Not to exceed 100 x rated A)		0.2...16 A 18...25 A	5 kA C1 (2 kA C1 for 65V DC — 1-pole) 2 kA C1	
EN/IEC 60934 (CBE)			0.2...5 A 6...25 A	400 A 800 A	
Maximum Voltage Ratings	250V AC 50/60 Hz 65V DC		480Y/277V AC 50/60 Hz 65V DC		
Temperature Range	-40...+149 °F (-40...+65 °C) non-condensing				
Operating Life	6000 operations @ rated current				
Housing Material	Glass-filled Polyamide 6.6				
Shock	25 G, 11 ms duration				
Vibration	5 G (10...500 Hz)				
Dielectric Strength	1500V AC		1600V AC		
Insulation Resistance	100 M Ohms @ 500V DC				
Terminal Type	Tubular Screw with Self-lifting box lug				
Wire Size	#22...10 AWG				
Recommended Wire Strip Length	0.44 in (11.2 mm)		Main Term — 0.51 in (13 mm) Aux Term — 0.41 in (10.4 mm)		
Terminal Torque	1.3...1.4 N•m (10...12 lb•in)		0.656 N•m (5 lb•in)		
Auxiliary Contact rating (N.O. or N.C.)	1.0 A AC or DC (Resistive Load)				

Bulletin 1492-GH & 1492-GS
Supplementary Protectors (Miniature Circuit Breakers)
 Product Selection

1492-GH

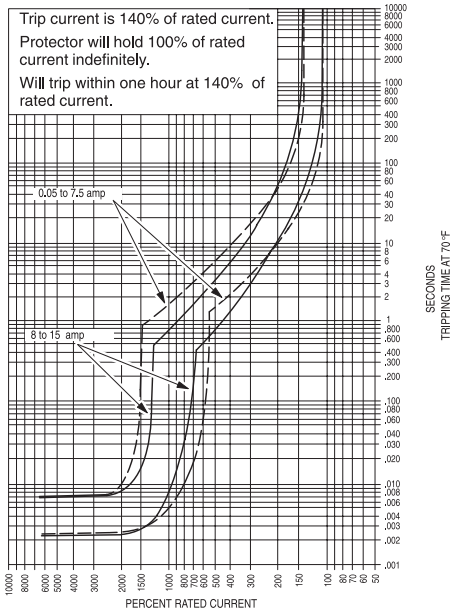

1492-GS

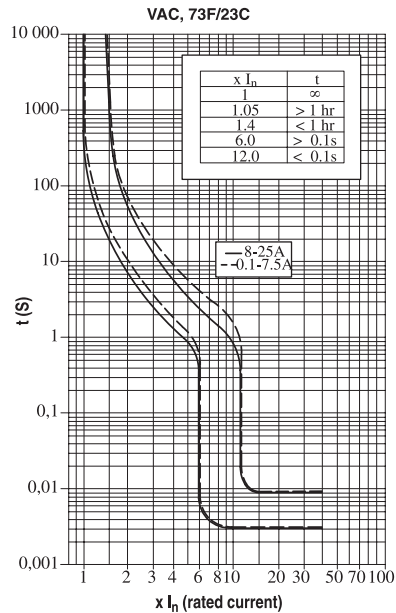

1492-GH/GS

To select a miniature circuit breaker, use the following procedure:
 1. Determine the inrush correction factor from the following table.

Inrush Ratio Correction Table					
Inrush Ratio	1:1 to 1:4	1:5	1:6	1:7	1:8
Factor	1.3	1.4	1.5	1.6	1.7

Note: For resistive loads use inrush correction factor of 1.0.

2. Determine the temperature correction factor from the following table.

Ambient Temperature Correction Table							
Ambient Temperature	70 °F (21.1 °C)	100 °F (37.8 °C)	120 °F (48.9 °C)	140 °F (60 °C)	160 °F (71.1 °C)	180 °F (82.2 °C)	200 °F (93.3 °C)
Factor	1.0	1.1	1.2	1.3	1.4	1.5	1.6

3. Determine the sealed current of the load being protected.

4. Multiply the sealed current by the two correction factors and select the closest higher ampere rating.

Example — For a solenoid with sealed current of 0.5 A, an inrush ratio of 1:8, and an ambient temperature of +110 °F (43.7 °C), (0.5 x 1.7 x 1.15 = 0.9775), select the 1.0 A miniature circuit breaker. Tripping time of the miniature circuit breaker is determined from the table below. Divide the miniature circuit breaker value by the temperature correction factor from the Ambient Temperature Correction Table above to determine the actual rated current referenced in the table below.

Tripping Times in Seconds at 70 °F (21.1 °C)								
Percent Rated Current	100%	200%	300%	400%	500%	600%	1000%	2000% Greater
Tripping Times (Seconds)	No Trip	10...40	3...18	1.5...9	0.8...6	0.003...4	0.009...2	Max. 0.02

Note: When several breakers are rail mounted adjacent to each other, the no-trip current will be 80% of rated current at 70 °F (21.1 °C).

Using selection table on page 4-13 select Bulletin 1492-GH/GS that allows full load current nearest without exceeding application current. Also, check that inrush current is less than trip range of 6...10 I_n .

Bulletin 1492-GH & 1492-GS

Supplementary Protectors (Miniature Circuit Breakers)

Product Selection, Continued/Approximate Dimensions

Amperage	1492-GH		1492-GS		
	1-Pole		1-Pole	2-Pole	3-Pole
	Cat. No.	Cat. No.	Cat. No.	Cat. No.	Cat. No.
0.2 A	1492-GH002	1492-GS1G002	1492-GS2G002	1492-GS3G002	
0.5 A	1492-GH005	1492-GS1G005	1492-GS2G005	1492-GS3G005	
0.8 A	1492-GH008	1492-GS1G008	1492-GS2G008	1492-GS3G008	
1.0 A	1492-GH010	1492-GS1G010	1492-GS2G010	1492-GS3G010	
1.2 A	1492-GH012	1492-GS1G012	1492-GS2G012	1492-GS3G012	
1.5 A	1492-GH015	1492-GS1G015	1492-GS2G015	1492-GS3G015	
2.0 A	1492-GH020	1492-GS1G020	1492-GS2G020	1492-GS3G020	
2.5 A	1492-GH025	1492-GS1G025	1492-GS2G025	1492-GS3G025	
3.0 A	1492-GH030	1492-GS1G030	1492-GS2G030	1492-GS3G030	
4.0 A	1492-GH040	1492-GS1G040	1492-GS2G040	1492-GS3G040	
5.0 A	1492-GH050	1492-GS1G050	1492-GS2G050	1492-GS3G050	
7.0 A	1492-GH070	1492-GS1G070	1492-GS2G070	1492-GS3G070	
10.0 A	1492-GH100	1492-GS1G100	1492-GS2G100	1492-GS3G100	
15.0 A	1492-GH150	1492-GS1G150	1492-GS2G150	1492-GS3G150	
16.0 A	—	1492-GS1G160	1492-GS2G160	1492-GS3G160	
20.0 A	—	1492-GS1G200	1492-GS2G200	1492-GS3G200	
25.0 A	—	1492-GS1G250	1492-GS2G250	1492-GS3G250	
Adding Auxiliary Contact	—	Add suffix — H1 for N.O. Aux. Add suffix — H2 for N.C. Aux. One Aux. may be installed in 1-pole device Maximum of two contacts may be installed in 2- & 3-pole devices			
Pieces Per Carton	1				

Approximate Dimensions

Dimensions are in inches (millimeters). Dimensions are not intended for manufacturing purposes.

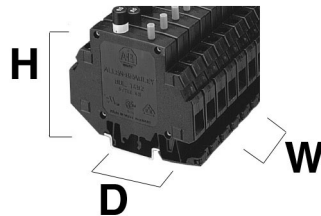

	1492-GH		1492-GS		
	1-Pole		1-Pole	2-Pole	3-Pole
Height	3.15 in (80 mm)		3.15 in (80 mm)		
Depth	2.89 in (73.4 mm)		3.48 in (88.5 mm)		
Width	0.49 in (12.4 mm)		0.49 in (12.5 mm)	0.98 in (25 mm)	1.47 in (37.5 mm)

Supplementary Protector/Miniature Circuit Breaker

Product Overview



Bulletin 1492-SP — Supplementary Protector/Miniature Circuit Breaker

- Energy Limiting Design — Protects Downstream Components Better than Conventional Breakers During Short Circuits
- Field Mountable Options for Selective Applications
- True IP2x Finger-Safe Design (Front)
- International Approvals — CE Marked, and Meets UL, CSA, and IEC (VDE, GL) Standards for Worldwide Acceptance
- Ratings to 480Y/277V AC @ 240/415V AC — 10 000 A Interrupt Rating
- AC and DC Voltage Ratings — in One Convenient Device
- A Positively Trip-Free Mechanism (Breaker Operation Cannot be Defeated by Holding the Handle in the ON Position)
- 3 Trip Curves: B, C, and D
- Time Delay (D Characteristic) for High Inrush Currents During Inductive Start-Ups Such as Transformers and Power Supplies
- Superior Shock and Vibration Resistance Capabilities — Helps to Prevent Nuisance Tripping

Table of Contents

Product Selection . . . 4-15
Specifications 4-18
Approximate
Dimensions 4-19

Standards Compliance

- UL 1077
- CSA 22.2 No. 235
- IEC/EN 60898, 60947-2
- UL File Number E65138

Bulletin 1492-SP series C devices are energy limiting, thermal magnetic type overcurrent protectors meeting UL 1077/CSA 22.2 No. 235, IEC/EN 60898. These devices are designed for the protection of a wide variety of products including:



- Solenoids
- Test Equipment
- Controller I/O Points
- Relay and Contractor Coils
- Computers
- Transformers
- Automotive Systems
- Power Supplies
- Medical Equipment
- Control Instrumentation

The Bulletin 1492-SP supplementary protectors/miniature circuit breakers are available in one-, one-pole plus neutral, two-, three-, and three-pole plus neutral units. One- and two-pole AC units also have limited DC ratings. Two- and three pole units are connected at the handle for simultaneous operation. Screw termination is standard on all Bulletin 1492-SP units. Both line and load side terminals accept #16...4 AWG (1.5...25 mm²) copper wire.

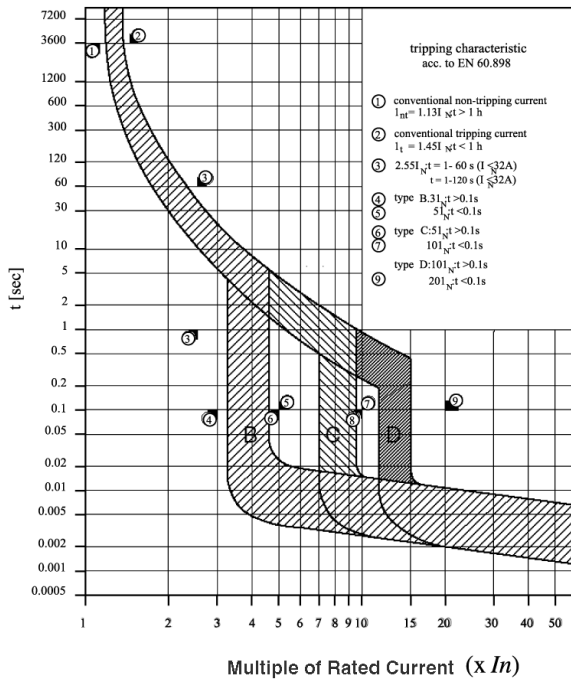
Tripping Characteristics
 1492-SP_at 30° C





Product Selection

Tripping Characteristics		Trip Curve B Resistive or Slightly Inductive	Trip Curve C Inductive	Trip Curve D Highly Inductive
		3...5 /n	5...10 /n	10...20 /n
Number of Poles	Continuous Current Rating (/n) Ampere	Cat. No.	Cat. No.	Cat. No.
1-Pole  IEC 240/415V AC UL/CSA 277V AC 48V DC 	0.5	—	1492-SP1C005	1492-SP1D005
	1	1492-SP1B010	1492-SP1C010	1492-SP1D010
	2	1492-SP1B020	1492-SP1C020	1492-SP1D020
	3	1492-SP1B030	1492-SP1C030	1492-SP1D030
	4	1492-SP1B040	1492-SP1C040	1492-SP1D040
	5	1492-SP1B050	1492-SP1C050	1492-SP1D050
	6	1492-SP1B060	1492-SP1C060	1492-SP1D060
	7	1492-SP1B070	1492-SP1C070	1492-SP1D070
	8	1492-SP1B080	1492-SP1C080	1492-SP1D080
	10	1492-SP1B100	1492-SP1C100	1492-SP1D100
	13	1492-SP1B130	1492-SP1C130	1492-SP1D130
	15	1492-SP1B150	1492-SP1C150	1492-SP1D150
	16	1492-SP1B160	1492-SP1C160	1492-SP1D160
	20	1492-SP1B200	1492-SP1C200	1492-SP1D200
	25	1492-SP1B250	1492-SP1C250	1492-SP1D250
	30	1492-SP1B300	1492-SP1C300	1492-SP1D300
	32	1492-SP1B320	1492-SP1C320	1492-SP1D320
40	1492-SP1B400	1492-SP1C400	1492-SP1D400	
50	1492-SP1B500	1492-SP1C500	1492-SP1D500	
63	1492-SP1B630	1492-SP1C630	1492-SP1D630	

Note: 1492-SP Circuit Breakers are also available with neutral (1-pole and 3-pole). Add a suffix of -N to cat. no.

Supplementary Protector/Miniature Circuit Breaker

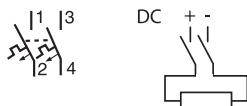
Product Selection, Continued

Tripping Characteristics		B Trip Resistive or Slightly Inductive 3...5 /n	C Trip Inductive 5...10 /n	D Trip Highly Inductive 10...20 /n
Number of Poles	Continuous Current Rating (n) Ampere	Cat. No.	Cat. No.	Cat. No.
2-Pole  IEC 415V AC UL/CSA 480Y/277V AC 125V DC 	0.5	—	1492-SP2C005	1492-SP2D005
	1	1492-SP2B010	1492-SP2C010	1492-SP2D010
	2	1492-SP2B020	1492-SP2C020	1492-SP2D020
	3	1492-SP2B030	1492-SP2C030	1492-SP2D030
	4	1492-SP2B040	1492-SP2C040	1492-SP2D040
	5	1492-SP2B050	1492-SP2C050	1492-SP2D050
	6	1492-SP2B060	1492-SP2C060	1492-SP2D060
	7	1492-SP2B070	1492-SP2C070	1492-SP2D070
	8	1492-SP2B080	1492-SP2C080	1492-SP2D080
	10	1492-SP2B100	1492-SP2C100	1492-SP2D100
	13	1492-SP2B130	1492-SP2C130	1492-SP2D130
	15	1492-SP2B150	1492-SP2C150	1492-SP2D150
	16	1492-SP2B160	1492-SP2C160	1492-SP2D160
	20	1492-SP2B200	1492-SP2C200	1492-SP2D200
	25	1492-SP2B250	1492-SP2C250	1492-SP2D250
	30	1492-SP2B300	1492-SP2C300	1492-SP2D300
	32	1492-SP2B320	1492-SP2C320	1492-SP2D320
	40	1492-SP2B400	1492-SP2C400	1492-SP2D400
	50	1492-SP2B500	1492-SP2C500	1492-SP2D500
	63	1492-SP2B630	1492-SP2C630	1492-SP2D630
3-Pole  IEC 415V AC UL/CSA 480Y/277V AC 	0.5	—	1492-SP3C005	1492-SP3D005
	1	1492-SP3B010	1492-SP3C010	1492-SP3D010
	2	1492-SP3B020	1492-SP3C020	1492-SP3D020
	3	1492-SP3B030	1492-SP3C030	1492-SP3D030
	4	1492-SP3B040	1492-SP3C040	1492-SP3D040
	5	1492-SP3B050	1492-SP3C050	1492-SP3D050
	6	1492-SP3B060	1492-SP3C060	1492-SP3D060
	7	1492-SP3B070	1492-SP3C070	1492-SP3D070
	8	1492-SP3B080	1492-SP3C080	1492-SP3D080
	10	1492-SP3B100	1492-SP3C100	1492-SP3D100
	13	1492-SP3B130	1492-SP3C130	1492-SP3D130
	15	1492-SP3B150	1492-SP3C150	1492-SP3D150
	16	1492-SP3B160	1492-SP3C160	1492-SP3D160
	20	1492-SP3B200	1492-SP3C200	1492-SP3D200
	25	1492-SP3B250	1492-SP3C250	1492-SP3D250
	30	1492-SP3B300	1492-SP3C300	1492-SP3D300
	32	1492-SP3B320	1492-SP3C320	1492-SP3D320
	40	1492-SP3B400	1492-SP3C400	1492-SP3D400
50	1492-SP3B500	1492-SP3C500	1492-SP3D500	
63	1492-SP3B630	1492-SP3C630	1492-SP3D630	

Note: 1492-SP Circuit Breakers are also available with neutral (1-pole and 3-pole). Add a suffix of -N to cat. no.

Additional Devices

Description		Cat. No.
Auxiliary Contacts	Auxiliary Contact Module Switches when protective device is operated manually or tripped electrically 1 N.O. – 1 N.C. Form C Contact	1492-ASPH3
	Auxiliary Contact Module Switches when protective device is operated manually or tripped electrically 2 N.O. – 2 N.C. 2 Form C Contact	1492-ASPHH3
	Auxiliary/Signal Alarm Contact Module 1 Auxillary Contact Switches when protective device Is operated manually or tripped electrically 1 N.O. – 1 N.C. Form C Contact 1 Signal Contact Switches when protective device Is tripped electrically 1 N.O. – 1 N.C. Form C Contact	1492-ASPHS3
Undervoltage Release Module Use the Undervoltage Release Module to trip the adjacent breaker poles when the applied voltage is less than the nominal voltage. Undervoltage trip is often used when loss of power and eventual restoration of power creates an unsafe or unknown set of condition.	50...115V AC 110...240V AC	1492-ASPU115 1492-ASPU230
Shunt Trip Module Use the Shunt Trip Module to trip the adjacent breaker poles from a remote location. The module is actuated by applying a voltage (Pickup Voltage) to the trip terminals. Shunt Trip Modules are often used in emergency shutdown circuits where multiple power circuits must be switched off from a single location.	110...415V AC (110...230V DC) 12...110V AC (12...60 VDC)	1492-ASPA1 1492-ASPA2
	Pieces Per Package	Cat. No.
Mounting Rail	10	199-DR1
End Anchor	—	1492-EAHJ35
Lockout Attachment	5	1492-ASPLOA

The following bus bars (communing links have CE approval only)

Type	No. of 1492-SP	Rated Operational Ia	Pieces Per Package	Cat. No.
Pin Style Commoning Links (may be cut to length, not for use with accessories)				
One Pole	1 m (56 per m)	40	1	1492-ACBCL1
Two Pole (1p + N)	1 m (26 per m)	30	1	1492-ACBCL2
Three Pole	1 m (16 per m)	30	1	1492-ACBCL3
End Cap for two and three pole	—	—	10	1492-ACBEC1
Fork Style Commoning Links (may be cut to length, not for use with accessories)				
One Pole	1 m (56 per m)	40	1	1492-ASPCL1
Three Pole	1 m (19 per m)	30	1	1492-ASPCL3
End Cap for two and three pole	—	—	10	1492-ASPEC1
Protective Covers for unused forks termination	—	—	10 sets (5/set)	1492-ASPCLPS
Fork Style Commoning Links (may not be cut)				
Four Pole	2	120	5	1492-ASPCL408
Four Pole	3	120	5	1492-ASPCL412
For 1492-SP with an Auxiliary contact				
One pole	2	85	—	1492-ASPCL1A02
One pole	6	85	—	1492-ASPCL1A06
One pole	9	85	—	1492-ASPCL1A09
Two pole (1p+N)	2	120	—	1492-ASPCL2A04
Two pole (1p+N)	3	120	—	1492-ASPCL2A06
Two pole (1p+N)	5	120	—	1492-ASPCL2A10
Three pole	2	120	—	1492-ASPCL3A06
Three pole	4	120	—	1492-ASPCL3A12

Supplementary Protector/Miniature Circuit Breaker

Product Selection, Continued/Specifications

Type	No. of 1492-SP	Rated Operational Ia	Pieces Per Package	Cat. No.
For multiple single pole 1492-SP, each with one Auxiliary	2x3 (1p)	120	—	1492-ASPCL3AP06
	2x3 (1p)+2 (1p)	120	—	1492-ASPCL3AP08
	3x3 (1p)	120	—	1492-ASPCL3AP09
For 1492-SP without Auxiliary contact				
One pole	2	85	—	1492-ASPCL102
One pole	6	85	—	1492-ASPCL106
One pole	12	85	—	1492-ASPCL112
Two pole (1p+N)	2	120	—	1492-ASPCL204
Two pole (1p+N)	3	120	—	1492-ASPCL206
Two pole (1p+N)	6	120	—	1492-ASPCL212
Three pole	2	120	—	1492-ASPCL306
Three pole	4	120	—	1492-ASPCL312
Incoming Terminals for fork style (Not for use in North American Installations)				
For max 25mm ² wire	—	—	—	1492-ASPCLT25
For max 35 mm ² wire	—	—	—	1492-ASPCLT35

Description	B Curve Resistive or Slightly Inductive Loads	C Curve Inductive Loads	D Curve Highly Inductive Loads
Tripping Characteristics	3...5 I _n	5...10 I _n	10...20 I _n
Dielectric Strength	1960V AC		
Shock	25 G Half Sine Wave for 11 ms (3 Axis)		
Vibration	Frequency Range: 10...2000 Hz Max. Amplitude (p-p) = 0.030 in Max. Acceleration = 5 G 2 hours each of 3 axis		
Operating Temperature Range	23...104 °F (-5...+40 °C) non-condensing		
Shipment and Short Term Temperature Limits	-40...+185 °F (-40...+85 °C)		
Housing Material	Nylon		
Wire Size	#18...8 AWG (1.0...25 mm ²)		
Recommended Wire Strip Length	0.51 in (13 mm)		
Electromechanical Life	6000 operations (1 operation = 2 switching events) ON/OFF		
Switched Neutral Rating	277V AC		

Description	B Curve Resistive or Slightly Inductive Loads	C Curve Inductive Loads	D Curve Highly Inductive Loads
Supplementary Protector			
Certifications	UL 1077, CSA 22.2 No. 235 UL File Number E65138		
Current Range	1...63 A	0.5...63 A	0.5...40 A
Withstand Rating	One-pole without series fuse	5 kA @ 277V AC UZ	
	Multi-pole without series fuse	5 kA @ 480Y/277V AC UZ	
	All poles without series fuse	1 pole — 5 kA @ 48V DC UZ 2 pole in series — 5 kA @ 125V DC UZ	
Miniature Circuit Breaker			
Certifications	IEC/EN 60898 (VDE) IEC/EN 60947-2 (GL)		
Current Range	1...63 A	0.5...63 A	0.5...40 A
Interrupt Rating One-Pole	10 kA @ 240V AC		
Interrupt Rating Multi-Pole	10 kA @ 415V AC		
Rated Impulse Withstand Voltage U _{imp}	4000V		
Rated Insulation Voltage U _i	440V AC		
Overload Category/Pollution Degree	III/3		
Rated Operation Voltage U _e	240/415V AC		
Approval	IEC/EN 60947-2 (GL)		
Rated Ultimate Short Circuit Breaking Capacity I _{cu}	15 kA 0.5 cos @ 240/415V AC		

Auxiliary Specifications

	Auxiliary Contact Module Dual Auxiliary Contact Module Auxiliary/Signal Alarm Module Cat. Nos. 1492-ASPH3 1492-ASPHH3 1492-SASPHS3	Undervoltage Release Module Cat. Nos. 1492-ASPU115 1492-ASPU230	Shunt Trip Module Cat. Nos. 1492-ASPA1 1492-ASPA2	
Degree of Protection	IP20 (IP00)			
Dimensions	See page 4-20			
Weight	0.045 kg	0.155 kg	0.155 kg	
Mechanical Lifespan	6000 operations	10 000 operations	4000 operations	
Minimum Impulse Duration	—	—	> 15 ms	
Minimum Command Time	—	—	≤ 200ms	
Operating Voltage	—	1492-ASPU115: U _n -115V AC, U _{min} -50V AC	1492-ASPA1: 110...415V AC, 110...230V AC	
	—	1492-ASPU230: U _n -230/240V AC, U _{min} -110V AC	1492-ASPA2: 12...110V AC, 12...60V AC	
Inrush Current	—	3.6/44 mA (AC/DC)	25/12 mA (AC) 15/2 mA (DC)	
Dropout	—	0.7...0.35 x U _s	—	
Voltage Range	—	—	0.7...1.1 x U _s	
IEC	Max. Operating Current	AC 13 @ 250V AC 3 A AC 15 @ 250V AC 0.5 A DC 12 @ 110V DC 0.5 A U _{min} -5V AC	—	
	Terminal Capacity IEC Rigid, CU	0.5...2.5 mm ² 2 x 0.5...2 x 2.5 mm ²	0.5...4.0 mm ² 2 x 0.5...2 x 2.5 mm ²	1.0...25 mm ² 2 x 1.0...2 x 4.0 mm ²
	Tightening Torque	0.8 N•m	1.1 N•m	2.4 N•m
UL 1077 CSA 22.2 No. 235	Max. Operating Current	@ 230V AC 2 A @ 110V DC 0.5 A U _{min} -5V CDC	—	
	Terminal Capacity CU	#18...14 AWG 2 x #18...2 x #14 AWG	#18...14 AWG 2 x #18...2 x #14 AWG	#18...8 AWG 2 x 18...2 x #12 AWG
	Tightening Torque	7 lb•in	10 lb•in	21 lb•in

Approximate Dimensions

Dimensions are shown in millimeters. Dimensions are not intended for manufacturing purposes.

Bulletin 1492-SP Series C

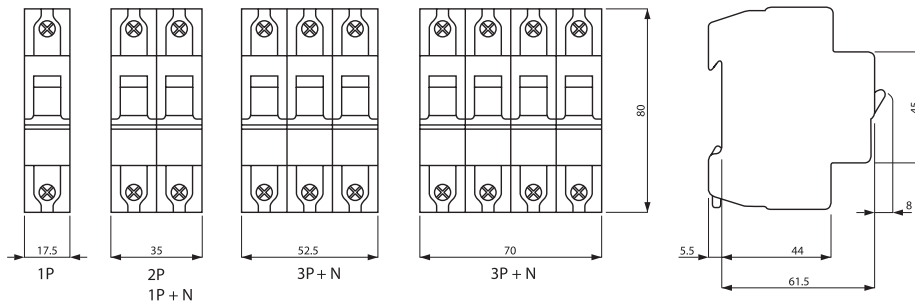

Bulletin 1492-SP

Supplementary Protector/Miniature Circuit Breaker

Approximate Dimensions, Continued

Approximate Dimensions

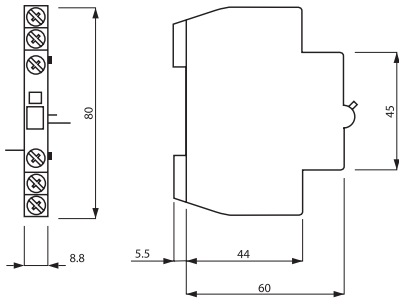

Cat. No.
1492-ASPHH3
1492-ASPHS3
1492-ASPH3

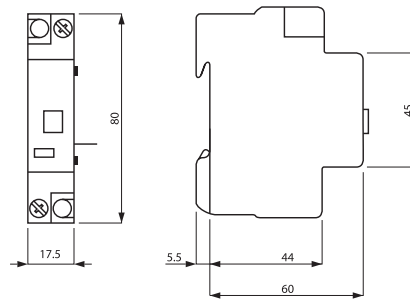

Cat. No. 1492-ASPU_ _ _

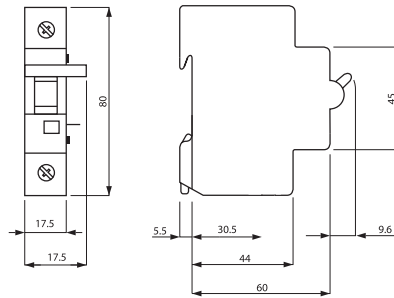

Cat. No. 1492-ASPA_



Bulletin 1492-SPU — Circuit Breaker with UL 489 Approval

- True IP2X finger safe design (front)
- Ratings to 240V AC — 10 000 A Interrupt Rating
- A positively trip-free mechanism (breaker operation cannot be defeated by holding the handle in the ON position)
- 3 trip curves: B, C, and D
- Time delay (D characteristic) for high inrush currents during inductive start-ups such as transformers and power supplies
- Superior shock and vibration resistance capabilities — helps to prevent nuisance tripping
- Mounts on DIN Rail
- Line and load connections may be reversed

Table of Contents

- Specifications 4-22
- Product Selection . . . 4-22
- Approximate Dimensions 4-22
- Standards Compliance**
- UL 489
- CSA 22.2 No. 5.1

Bulletin 1492-SPU circuit breakers are thermal magnetic type overcurrent protective devices meeting UL 489/CSA 22.2 No. 5.1. These devices are designed for the protection of a wide variety of products including:

- Solenoids
- Branch Circuit
- Solenoids
- Test Equipment
- Controller I/O Points
- Relay and Contactor Coils
- Computers
- Transformers
- Automotive Systems
- Power Supplies
- Medical Equipment
- Control Instrumentation

Mounting

Multiple single-pole circuit breakers may be mounted adjacent to each other if switching the same polarity. If multiple circuit breakers are switching different polarities, allow a minimum spacing of 0.62 in. between circuit breakers. Use of (2) Cat. No. 1492-EA35 or (2) Cat. No. 1492-ER35 meets the spacing requirement.

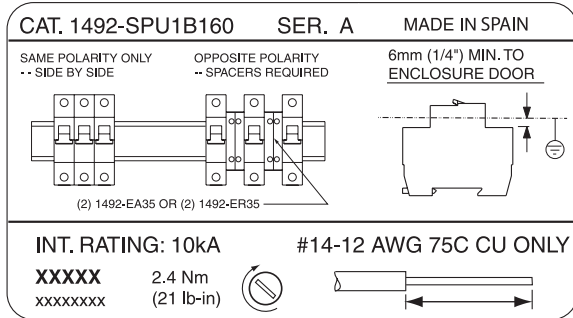

Circuit Breaker with UL 489 Approval

Specification/Product Selection/Approximate Dimensions

Specifications

Specifications	B Trip Resistive or Slightly Inductive	C Trip Inductive	D Trip Highly Inductive
Tripping Characteristic	3...5 /n	5...10 /n	10...20 /n
Cerifications	UL 489, CSA 22.2 No. 5.1		
Maximum Voltage Rating	240V AC		
Dielectric Strength	1960V AC		
Shock	25 g Half Sine Wave for 11 ms (2 Axis)		
Operating Temperature Range	23...104 °F (-5...+40 °C) non-condensing		
Shipment and Short Term Temperature Limits	-40...+185 °F (-40...+85 °C)		
Tripping Characteristic Reference Temperature	25 °C		
Housing Material	Nylon		
Wire Size	#14...12 AWG 75 C Cu Only		
Recommended Wire Strip Length	0.51 in (13 mm)		
Interrupt Rating	1-pole 10 kA @ 240V AC		
Terminal Torque	2.4 N•m (21 lb•in)		
Pieces per Carton	12		

Product Selection

Continuous Current Rating (In) Ampere	Cat. No.	Cat. No.	Cat. No.
0.5	—	1492-SPU1C005	1492-SPU1D005
1	1492-SPU1B010	1492-SPU1C010	1492-SPU1D010
1.5	1492-SPU1B015	1492-SPU1C015	1492-SPU1D015
2	1492-SPU1B020	1492-SPU1C020	1492-SPU1D020
3	1492-SPU1B030	1492-SPU1C030	1492-SPU1D030
4	1492-SPU1B040	1492-SPU1C040	1492-SPU1D040
5	1492-SPU1B050	1492-SPU1C050	1492-SPU1D050
6	1492-SPU1B060	1492-SPU1C060	1492-SPU1D060
7	1492-SPU1B070	1492-SPU1C070	1492-SPU1D070
8	1492-SPU1B080	1492-SPU1C080	1492-SPU1D080
10	1492-SPU1B100	1492-SPU1C100	1492-SPU1D100
13	1492-SPU1B130	1492-SPU1C130	1492-SPU1D130
15	1492-SPU1B150	1492-SPU1C150	—
16	1492-SPU1B160	1492-SPU1C160	—
20	1492-SPU1B200	1492-SPU1C200	—

Approximate Dimensions

Dimensions are shown in millimeters. Dimensions are not intended for manufacturing purposes.

