

# CompactLogix Controllers Specifications

## CompactLogix 5370 Controller Catalog Numbers

1769-L16ER-BB1B, 1769-L18ER-BB1B, 1769-L18ERM-BB1B, 1769-L19ER-BB1B, 1769-L24ER-QB1B, 1769-L24ER-QBFC1B, 1769-L27ERM-QBFC1B, 1769-L30ER, 1769-L30ER-NSE, 1769-L30ERM, 1769-L30ERMS, 1769-L33ER, 1769-L33ERM, 1769-L33ERMS, 1769-L36ERM, 1769-L36ERMS



## 1769 Packaged Controller Catalog Numbers

1769-L23-QBFC1B, 1769-L23E-QB1B, 1769-L23E-QBFC1B



## 1769 Modular Controller Catalog Numbers

1769-L31, 1769-L32C, 1769-L35CR, 1769-L32E, 1769-L35E



## 1768 Controller Catalog Numbers

1768-L43, 1768-L43S, 1768-L45, 1768-L45S



## Memory Card Catalog Numbers

1784-CF128, 1784-SD1, 1784-SD2

Topic	Page
CompactLogix 5370 Controllers	5
1769 Packaged CompactLogix Controllers with Embedded I/O	37
1769 Modular CompactLogix Controllers	48
1768 CompactLogix Controllers	52
Controller Memory Use	59
Controller Compatibility	60
Controller Connections	63
Determine Total Connection Use	65
CompactLogix Controller Accessories	66



**Table 1 - Environmental Specifications - 1769 CompactLogix Controllers and Compact GuardLogix 5370 Controllers**

Attribute	1769-L16ER-BB1B, 1769-L18ER-BB1B, 1769-L18ERM-BB1B, 1769-L19ER-BB1B	1769-L24ER-QB1B, 1769-L24ER-QBFC1B, 1769-L27ERM-QBFC1B	1769-L30ER, 1769-L30ER-NSE, 1769-L30ERM, 1769-L33ER, 1769-L33ERM, 1769-L36ERM	1769-L30ERMS, 1769-L33ERMS, 1769-L36ERMS	1769-L23-QBFC1B, 1769-L23E-QB1B, 1769-L23E-QBFC1B	1769-L31, 1769-L32C, 1769-L35CR, 1769-L32E, 1769-L35E
Temperature, operating IEC 60068-2-1 (Test Ad, Operating Cold), IEC 60068-2-2 (Test Bd, Operating Dry Heat), IEC 60068-2-14 (Test Na, Operating Thermal Shock)	-20...60 °C (-4...140 °F)	0...60 °C (32...140 °F)				
Temperature, storage IEC 60068-2-1 (Test Ab, Unpackaged Nonoperating Cold), IEC 60068-2-2 (Test Bb, Unpackaged Nonoperating Dry Heat), IEC 60068-2-14 (Test Na, Unpackaged Nonoperating Thermal Shock)	-40...85 °C (-40...185 °F)					
Temperature, surrounding air, max	60 °C (140 °F)					
Relative humidity IEC 60068-2-30 (Test Db, Unpackaged Damp Heat)	5...95% noncondensing					
Vibration IEC 60068-2-6 (Test Fc, Operating)	2 g @ 10...500 Hz <sup>(1)</sup>		5 g @ 10...500 Hz		5 g @ 10...500 Hz	
Shock, operating IEC 60068-2-27 (Test Ea, Unpackaged Shock)	30 g <sup>(1)</sup>		20 g - DIN rail 30 g - Panel		20 g - DIN rail 30 g - Panel	
Shock, nonoperating IEC 60068-2-27 (Test Ea, Unpackaged Shock)	50 g <sup>(1), (2)</sup>		30 g - DIN rail 40 g - Panel		30 g - DIN rail 40 g - Panel	
Emissions CISPR 11	IEC 61000-6-4					
ESD immunity IEC 61000-4-2	6 kV contact discharges 8 kV air discharges				4 kV contact discharges 8 kV air discharges	6 kV contact discharges 8 kV air discharges

**Table 1 - Environmental Specifications - 1769 CompactLogix Controllers and Compact GuardLogix 5370 Controllers**

Attribute	1769-L16ER-BB1B, 1769-L18ER-BB1B, 1769-L18ERM-BB1B, 1769-L19ER-BB1B	1769-L24ER-QB1B, 1769-L24ER-QBFC1B, 1769-L27ERM-QBFC1B	1769-L30ER, 1769-L30ER-NSE, 1769-L30ERM, 1769-L33ER, 1769-L33ERM, 1769-L36ERM	1769-L30ERMS, 1769-L33ERMS, 1769-L36ERMS	1769-L23-QBFC1B, 1769-L23E-QB1B, 1769-L23E-QBFC1B	1769-L31, 1769-L32C, 1769-L35CR, 1769-L32E, 1769-L35E
Radiated RF immunity IEC 61000-4-3	10V/m with 1 kHz sine-wave 80% AM from 80...2000 MHz 10V/m with 200 Hz 50% Pulse 100% AM @ 900 MHz 10V/m with 200 Hz 50% Pulse 100% AM @ 1890 MHz 10V/m with 1 kHz sine-wave 80% AM from 2000...2700 MHz		10V/m with 1 kHz sine-wave 80% AM from 80...2000 MHz 10V/m with 200 Hz 50% Pulse 100% AM @ 900 MHz 10V/m with 200 Hz 50% Pulse 100% AM @ 1890 MHz 3V/m with 1 kHz sine-wave 80% AM from 2000...2700 MHz		10V/m with 200 Hz 50% Pulse 100% AM at 900 MHz 10V/m with 200 Hz 50% Pulse 100% AM at 1890 MHz 10V/m with 1 kHz sine-wave 80% AM from 80...2000 MHz 10V/m with 1 kHz sine-wave 80% AM from 2000...2700 MHz	<u>1769-L31</u> , <u>1769-L32C</u> , <u>1769-L35CR</u> 10V/m with 1 kHz sine-wave 80% AM from 80...2000 MHz 10V/m with 200 Hz 50% Pulse 100% AM @ 900 MHz 10V/m with 200 Hz 50% Pulse 100% AM @ 1890 MHz  <u>1769-L32E</u> , <u>1769-L35E</u> 10V/m with 1 kHz sine-wave 80% AM from 80...2000 MHz 10V/m with 200 Hz 50% Pulse 100% AM @ 900 MHz 10V/m with 200 Hz 50% Pulse 100% AM @ 1890 MHz 3V/m with 1 kHz sine-wave 80% AM from 2000...2700 MHz
EFT/B immunity IEC 61000-4-4	±3 kV at 5 kHz on power ports ±3 kV at 5 kHz on signal ports ±3 kV at 5 kHz on communication ports		±3 kV at 5 kHz on communication ports	±3 kV at 5 kHz on communication ports ±4 kV at 5 kHz on Protective Earth (PE)	±2 kV at 5 kHz on power ports ±2 kV at 5 kHz on signal ports ±2 kV at 5 kHz on communication ports	<u>1769-L31</u> , <u>1769-L32C</u> , <u>1769-L35CR</u> ±2 kV at 5 kHz on communication ports <u>1769-L32E</u> , <u>1769-L35E</u> ±3 kV at 5 kHz on power ports ±3 kV at 5 kHz on communication ports
Surge transient immunity IEC 61000-4-5	±1 kV line-line (DM) and ±2 kV line-earth (CM) on power ports ±1 kV line-line (DM) and ±2 kV line-earth (CM) on signal ports ±2 kV line-earth (CM) on communication ports	±1 kV line-line (DM) and ±2 kV line-earth (CM) on power ports ±1 kV line-line (DM) and ±2 kV line-earth (CM) on signal ports ±2 kV line-earth (CM) on shielded ports ±2 kV line-earth (CM) on communication ports	±2 kV line-earth (CM) on communication ports		±1 kV line-line (DM) and ±2 kV line-earth (CM) on power ports ±1 kV line-line (DM) and ±2 kV line-earth (CM) on signal ports ±2 kV line-earth (CM) on shielded ports ±2 kV line-earth (CM) on communication ports	<u>1769-L31</u> Channel 0: ±2 kV line-earth (CM) on shielded ports Channel 1: ±1 kV line-earth (CM) on shielded ports  <u>1769-L32C</u> , <u>1769-L35CR</u> , <u>1769-L32E</u> , <u>1769-L35E</u> ±2 kV line-earth (CM) on communication ports
Conducted RF immunity IEC 61000-4-6	10Vrms with 1 kHz sine-wave 80% AM from 150 kHz...80 MHz					

- (1) If you are mounting a CompactLogix™ 5370 L1 controller on an EN 50 022 - 35 x 15 mm (1.38 x 0.59 in.) DIN rail, you must first adhere a bumper on the back of the controller. Failure to install the bumper before mounting the controller results in the system failing to meet this specification. For more information, see the CompactLogix 5370 Controllers User Manual, publication [1769-UM021](#).
- (2) If you are mounting a CompactLogix 5370 L1 controller on an EN 50 022 - 35 x 15 mm (1.38 x 0.59 in.) DIN rail, the Shock, nonoperating specification = 30 g.

**Table 2 - Environmental Specifications - 1768-CompactLogix Controllers**

Attribute	1768-L43, 1768-L43S, 1768-L45, 1768-L45S
Temperature, operating IEC 60068-2-1 (Test Ad, Operating Cold), IEC 60068-2-2 (Test Bd, Operating Dry Heat), IEC 60068-2-14 (Test Na, Operating Thermal Shock)	0...60 °C (32...140 °F)
Temperature, storage IEC 60068-2-1 (Test Ab, Unpackaged Nonoperating Cold), IEC 60068-2-2 (Test Bb, Unpackaged Nonoperating Dry Heat), IEC 60068-2-14 (Test Na, Unpackaged Nonoperating Thermal Shock)	-40...85 °C (-40...185 °F)
Temperature, surrounding air, max	60 °C (140 °F)
Relative humidity IEC 60068-2-30 (Test Db, Unpackaged Damp Heat)	5...95% noncondensing
Vibration IEC 60068-2-6 (Test Fc, Operating)	5 g @ 10...500 Hz
Shock, operating IEC 60068-2-27 (Test Ea, Unpackaged Shock)	30 g
Shock, nonoperating IEC 60068-2-27 (Test Ea, Unpackaged Shock)	50 g
Emissions CISPR 11	IEC 61000-6-4
ESD immunity IEC 61000-4-2	6 kV contact discharges 8 kV air discharges
Radiated RF immunity IEC 61000-4-3	10V/m with 1 kHz sine-wave 80% AM from 80...2000 MHz 10V/m with 200 Hz 50% Pulse 100% AM @ 900 MHz 10V/m with 200 Hz 50% Pulse 100% AM @ 1890 MHz 3V/m with 1 kHz sine-wave 80% AM from 2000...2700 MHz
EFT/B immunity IEC 61000-4-4	±4 kV at 5 kHz on communication ports
Surge transient immunity IEC 61000-4-5	±2 kV line-earth (CM) on communication ports
Conducted RF immunity IEC 61000-4-6	10 Vrms with 1 kHz sine-wave 80% AM from 150 kHz...80 MHz

# CompactLogix 5370 Controllers

CompactLogix 5370 L1 Control System

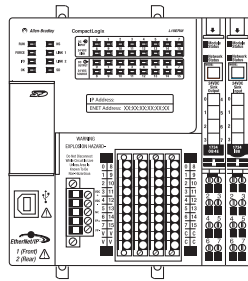

CompactLogix 5370 L2 Control System

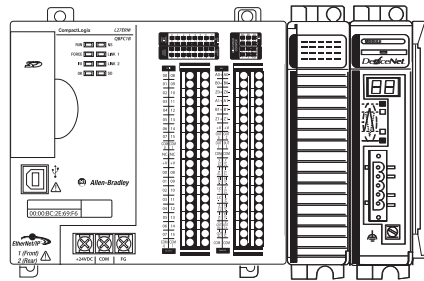

CompactLogix 5370 L3 Control System

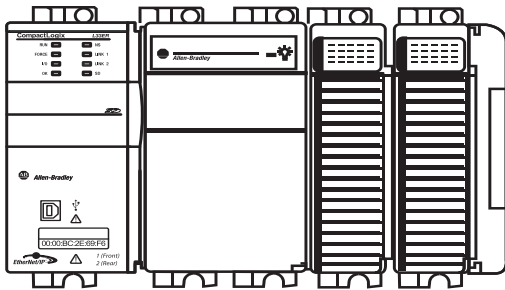

Compact GuardLogix® 5370 Control System

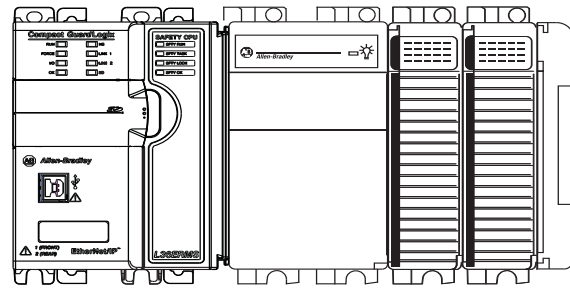

CompactLogix 5370 controllers provide scalable controller solutions to address a wide variety of applications. All CompactLogix 5370 controllers provide the following functionality:

- Two EtherNet™/IP ports
- One USB port
- Support for local expansion modules
- Control of local and distributed I/O modules
- Use of 1784-SD1 or 1784-SD2 Secure Digital (SD) card for nonvolatile memory
- A battery is no longer necessary because of the internal energy-storage solution

Some CompactLogix 5370 controllers provide the following functionality:

- Built-in power supply
- Some combination of embedded digital, analog, and high-speed counter modules
- Support for Integrated Motion over an EtherNet/IP network
- Access to DeviceNet™ networks

The Compact GuardLogix controller is a 1769-L3 CompactLogix controller that provides safety control to achieve SIL CL3 according to EN62061 / EN 61511-1 / IEC 61508 and PLe according to EN ISO 13849-1. A major benefit of this system is that it's still one project, safety and standard together.

Application	Description
SIL 1, 2, 3	<p>The Compact GuardLogix controller system is type-approved and certified for use in safety applications up to and including SIL 3 according to IEC 61508, and applications up to and including PLe/Cat.4 according to ISO 13849-1. For more information, see the following:</p> <ul style="list-style-type: none"> <li>• GuardLogix 5570 and Compact GuardLogix 5370 Controllers Systems Safety Reference Manual, publication <a href="#">1756-RM099</a></li> <li>• Compact GuardLogix 5370 Controllers User Manual, publication <a href="#">1769-UM002</a></li> <li>• GuardLogix Safety Application Instruction Set Reference Manual, publication <a href="#">1756-RM095</a></li> </ul>

During development, safety and standard have the same rules. The following are allowed:

- Multiple programmers
- Online editing
- Forcing

Once the project is tested and ready for final validation, you apply the safety application signature and safety-lock the application. This process sets the safety task to a SIL 3 integrity level. The Compact GuardLogix enforces the SIL 3 integrity level. When safety memory is locked and protected, the safety logic cannot be modified and all safety functions operate with SIL 3 integrity. On the standard side of the Compact GuardLogix controller, all functions operate like a regular Logix controller. Thus online editing, forcing, and other activities are all allowed.

Standard logic and external devices, like HMIs or other controllers, can read safety memory with this level of integration. This level of integration removes the need to condition safety memory for use elsewhere. The result is easy system-wide integration and the ability to display safety status on displays or marquees. Use Guard I/O™ modules for field device connectivity. For safety interlocking between Compact GuardLogix controllers, use Ethernet or ControlNet™ networks. Multiple Compact GuardLogix controllers can share safety data for zone to zone interlocking, or one Compact GuardLogix controller can use remote distributed safety I/O between different cells/areas.

**Table 3 - Features - CompactLogix 5370 Controllers and Compact GuardLogix 5370 Controllers**

Feature	1769-L16ER-BB1B, 1769-L18ER-BB1B, 1769-L18ERM-BB1B, 1769-L19ER-BB1B	1769-L24ER-QB1B, 1769-L24ER-QBFC1B, 1769-L27ERM-QBFC1B	1769-L30ER, 1769-L30ER-NSE, 1769-L30ERM, 1769-L33ER, 1769-L33ERM, 1769-L36ERM	1769-L30ERMS, 1769-L33ERMS, 1769-L36ERMS
Controller tasks:	<ul style="list-style-type: none"> <li>• 32 tasks</li> <li>• 100 programs/task</li> </ul>			
Built-in communication ports	<ul style="list-style-type: none"> <li>• Two EtherNet/IP ports - CompactLogix 5370 controllers have two EtherNet/IP ports to connect to an EtherNet/IP network. The ports carry the same network traffic as part of the embedded switch of the controller. However, the controller uses only one IP address.</li> <li>• One USB port (only for temporary connection)</li> </ul>			
Communication options	EtherNet/IP	<ul style="list-style-type: none"> <li>• EtherNet/IP</li> <li>• DeviceNet via 1769-SDN scanner</li> </ul>		
EtherNet/IP node, max	<ul style="list-style-type: none"> <li>• 1769-L16ER-BB1B: Up to four nodes</li> <li>• 1769-L18ER-BB1B, 1769-L18ERM-BB1B, 1769-L19ER-BB1B: Up to 8 nodes</li> </ul>	<ul style="list-style-type: none"> <li>• 1769-L24ER-QB1B, 1769-L24ER-QBFC1B: Up to 8 nodes</li> <li>• 1769-L27ERM-QBFC1B: Up to 16 nodes</li> </ul>	<ul style="list-style-type: none"> <li>• 1769-L30ER, 1769-L30ER-NSE, 1769-L30ERM, 1769-L30ERMS: Up to 16 nodes</li> <li>• 1769-L33ER, 1769-L33ERM, 1769-L33ERMS: Up to 32 nodes</li> <li>• 1769-L36ERM, 1769-L36ERMS: Up to 48 nodes</li> </ul>	
Controller connections	256			
Embedded I/O modules	<ul style="list-style-type: none"> <li>• 16 DC digital inputs</li> <li>• 16 DC digital outputs</li> </ul>	All controllers: <ul style="list-style-type: none"> <li>• 16 DC digital inputs</li> <li>• 16 DC digital outputs</li> </ul> Only 1769-L24ER-QBFC1B and 1769-L27ERM-QBFC1B: <ul style="list-style-type: none"> <li>• 4 high-speed counters</li> <li>• 4 high-speed counter outputs</li> <li>• 4 universal analog inputs</li> <li>• 2 analog output points</li> </ul>	None	
Sockets, max	32			
Integrated Motion over an EtherNet/IP network	1769-L18ERM-BB1B - 1 or 2 axes	1769-L27ERM-QBFC1B - As many as 4 axes	<ul style="list-style-type: none"> <li>• 1769-L30ERM, 1769-L30ERMS - As many as 4 axes</li> <li>• 1769-L33ERM, 1769-L33ERMS - As many as 8 axes</li> <li>• 1769-L36ERM, 1769-L36ERMS - As many as 16 axes</li> </ul>	
Programming languages	<ul style="list-style-type: none"> <li>• Relay ladder<sup>(1)</sup></li> <li>• Structured Text</li> <li>• Function block</li> <li>• SFC</li> </ul>			
Integrated safety	N/A			Yes

(1) The Compact GuardLogix 5370 controllers support only the relay ladder programming language in the safety task. The Compact GuardLogix 5370 controllers support all listed programming languages in the standard task.

**Table 4 - Technical Specifications - CompactLogix 5370 Controllers and Compact GuardLogix 5370 Controllers**

Attribute	1769-L16ER-BB1B, 1769-L18ER-BB1B, 1769-L18ERM-BB1B, 1769-L19ER-BB1B	1769-L24ER-QB1B, 1769-L24ER-QBFC1B, 1769-L27ERM-QBFC1B	1769-L30ER, 1769-L30ER-NSE, 1769-L30ERM, 1769-L33ER, 1769-L33ERM, 1769-L36ERM	1769-L30ERMS, 1769-L33ERMS, 1769-L36ERMS
User memory	<ul style="list-style-type: none"> <li>1769-L16ER: 384 KB</li> <li>1769-L18ER, 1769-L18ERM: 512 KB</li> <li>1769-L19ER-BB1B: 1 MB</li> </ul>	<ul style="list-style-type: none"> <li>1769-L24ER-QB1B, 1769-L24ER-QBFC1B: 750 KB</li> <li>1769-L27ERM-QBFC1B: 1 MB</li> </ul>	<ul style="list-style-type: none"> <li>1769-L30ER, 1769-L30ER-NSE, 1769-L30ERM: 1 MB</li> <li>1769-L33ER, 1769-L33ERM: 2 MB</li> <li>1769-L36ERM: 3 MB</li> </ul>	<ul style="list-style-type: none"> <li>1769-L30ERMS: 1 MB standard + 0.5 MB safety</li> <li>1769-L33ERMS: 2 MB standard + 1 MB safety</li> <li>1769-L36ERMS: 3 MB standard + 1.5 MB safety</li> </ul>
Optional nonvolatile memory	1784-SD1 card with 1 Gb of available memory (shipped with controller) 1784-SD2 card with 2 Gb of available memory (available for separate ordering)			
Number of local expansion modules, max <sup>(1)</sup>	<ul style="list-style-type: none"> <li>1769-L16ER-BB1B: Six 1734 POINT I/O™ modules</li> <li>1769-L18ER-BB1B, 1769-L18ERM-BB1B, 1769-L19ER-BB1B: Eight 1734 POINT I/O modules</li> </ul>	Four 1769 Compact I/O modules	<ul style="list-style-type: none"> <li>1769-L30ER, 1769-L30ER-NSE, 1769-L30ERM, 1769-L30ERMS: Eight 1769 Compact I/O™ modules</li> <li>1769-L33ER, 1769-L33ERM, 1769-L33ERMS: Sixteen 1769 Compact I/O modules</li> <li>1769-L36ERM, 1769-L36ERMS: Thirty 1769 Compact I/O modules</li> </ul>	
Number of I/O module banks, max	N/A	1	3	
Current draw @ 5V DC, controller power	1 A	<ul style="list-style-type: none"> <li>1769-L24ER-QB1B: 1.54 A Value rated at the following ambient temperatures: 40 °C (104 °F), 55 °C (131 °F), 60 °C (140 °F).</li> <li>1769-L24ER-QBFC1B and 1769-L27ERM-QBFC1B: 1 A Value rated at the following ambient temperatures: 40 °C (104 °F), 55 °C (131 °F), 60 °C (140 °F).</li> </ul>	500 mA	850 mA
Current draw @ 24V DC, controller power	N/A	<ul style="list-style-type: none"> <li>1769-L24ER-QB1B: 0.95A Value rated at the following ambient temperatures: 40 °C (104 °F), 55 °C (131 °F), 60 °C (140 °F).</li> <li>1769-L24ER-QBFC1B and 1769-L27ERM-QBFC1B: 0.8 A Value rated at the following ambient temperatures: 40 °C (104 °F), 55 °C (131 °F), 60 °C (140 °F).</li> </ul>	225 mA	700 mA
Current draw @ 24V DC, field power, max	3 A - Combined total for all devices that draw current from field power connections Input: 5 mA Output: 500 mA	N/A		
Power dissipation, max	11.5 W	<ul style="list-style-type: none"> <li>1769-L24ER-QB1B: 12 W</li> <li>1769-L24ER-QBFC1B, L27ERM-QBFC1B: 21 W</li> </ul>	4.5 W	6.5 W
Isolation voltage	50V (continuous), Basic Insulation Type Tested at 500V AC for 60 s, System to Field	30V (continuous), Basic Insulation Type, USB to system, Ethernet to system and Ethernet to Ethernet Type tested at 500V AC for 60 s		50V, Basic Insulation Type Tested at 500V AC for 60 s, System to Communication ports.
Short circuit protection, field power	Internal fuse, Non-replaceable	N/A		
Recommended external short circuit protection, field power	User-provided 4...5 A @ 3.15...5.5 A <sup>2</sup> t fuse	N/A		
Weight, approx	0.66 kg (1.5 lb)	<ul style="list-style-type: none"> <li>1769-L24ER-QB1B = 0.63 kg (1.39 lb)</li> <li>1769-L24ER-QBFC1B and 1769-L27ERM-QBFC1B = 0.9 kg (1.9 lb)</li> </ul>	0.31 kg (0.68 lb)	0.54 kg (1.18 lb)

**Table 4 - Technical Specifications - CompactLogix 5370 Controllers and Compact GuardLogix 5370 Controllers**

Attribute	1769-L16ER-BB1B, 1769-L18ER-BB1B, 1769-L18ERM-BB1B, 1769-L19ER-BB1B	1769-L24ER-QB1B, 1769-L24ER-QBFC1B, 1769-L27ERM-QBFC1B	1769-L30ER, 1769-L30ER-NSE, 1769-L30ERM, 1769-L33ER, 1769-L33ERM, 1769-L36ERM	1769-L30ERMS, 1769-L33ERMS, 1769-L36ERMS
Module width	100.00 mm (3.94 in.)	1769-L24ER-QB1B = 115.00 mm (4.53 in.) 1769-L24ER-QBFC1B and 1769-L27ERM-QBFC1B = 140 mm (5.51 in.)	55.00 mm (2.17 in.)	89.00 mm (3.50 in.)
Module location	DIN rail mount	DIN rail or panel mount		
Panel-mounting screw torque	N/A	1.1...1.8 N•m (10...16 lb•in) - use M4 or #8 screws		
Embedded power supply	24V DC input, isolated	24V DC Input, isolated	1769-PA2, 1769-PB2, 1769-PA4, 1769-PB4	
Power supply distance rating	NA		<ul style="list-style-type: none"> <li>Controller and 1769-SDN: 4</li> <li>1769 Compact I/O modules: 4...8, depending on module</li> </ul>	4 (3 I/O modules between controller and power supply)
Wire category <sup>(2)</sup>	1 - signal ports 1 - power ports 2 - communication ports		2 - communication ports	
Wire type, Ethernet	RJ-45 connector according to IEC 60603-7, 2 or 4 pair Category 5e minimum cable according to TIA 568-B.1 or Category 5 cable according to ISO/IEC 24702			
Wire type, power terminals and embedded I/O connections	Copper		N/A	
Wire size, power terminals <sup>(3)</sup>	0.051...3.31 mm <sup>2</sup> (30...12 AWG) solid or stranded copper wire rated at 75 °C (167 °F), or greater, 1.2 mm (3/64 in.) insulation, max Each terminal accepts 1 or 2 wires	0.25...2.50 mm <sup>2</sup> (22...14 AWG) solid copper wire rated at 75 °C (167 °F), or greater 1.2 mm (3/64 in.) insulation, max Each terminal accepts only 1 wire	N/A	
Wire stripping length, power terminals <sup>(3)</sup>	10 mm (0.39 in)	8 mm (0.31 in)	N/A	
Screw torque, power terminals <sup>(3)</sup>	0.5...0.6 N-m (4.4...5.3 lb-in)	1.0...1.2 N-m (8.9...10.6 lb-in)	N/A	
Wire size, embedded I/O connections	0.205...1.31 mm <sup>2</sup> (24...16 AWG) solid or stranded copper wire rated at 75 °C (167 °F), or greater 1.2 mm (3/64 in.) insulation, max or 90 °C (194 °F) Each terminal accepts only 1 wire		N/A	
Wire stripping length, embedded I/O connections	10 mm (0.39 in)		N/A	
North American temperature code	T4A	T3C	T5	
IEC temperature code	T4		T5	
Enclosure type rating	None (open-style)			

- (1) You can use up to the maximum number of local expansion modules with the CompactLogix 5370 L1 controllers that are listed as long as the total current drawn by the embedded I/O and local expansion modules does not exceed both the available POINTBus backplane current of 1 A and the field power current of 3 A. For more information on POINTBus backplane current and field-power current considerations when installing local expansion modules, see [page 11](#).
- (2) Use this Conductor Category information for planning conductor routing. See the Industrial Automation Wiring and Grounding Guidelines, publication [1770-4.1](#) and the appropriate system-level installation manual.
- (3) Regarding the CompactLogix 5370 L1 controllers, this specification applies to connecting wires to the power connector that is inserted in the controller. Regarding the CompactLogix 5370 L2 controllers, this specification applies to connecting wires to power terminals built into the controller.



## Real-time Clock Accuracy

The following table lists the real-time clock accuracy specifications for the CompactLogix 5370 controllers.

Ambient Temperature	Accuracy
0 °C (32 °F)	-143...42 s/mo
25 °C (77 °F)	-78...91 s/mo
40 °C (104 °F)	-101...73 s/mo
60 °C (140 °F)	-204...-4.50 s/mo

## Real-time Clock Hold-up Times

The following table lists the typical real-time clock hold-up specifications for the CompactLogix 5370 controllers.

---

**IMPORTANT** The values in the following table are typical and can vary with some CompactLogix 5370 control systems.

---

Ambient Temperature	Holdup Time, Typical
0 °C (32 °F)	40 days
25 °C (77 °F)	35 days
40 °C (104 °F)	28 days
60 °C (140 °F)	16 days

The I/O module support for CompactLogix 5370 controller systems varies by controller.

## I/O Module Support - CompactLogix 5370 L1 Controllers

The CompactLogix 5370 L1 controllers offer an embedded I/O module and the option to use 1734 POINT I/O modules as local expansion modules.

The embedded I/O module provides the following:

- 16 sinking 24V DC digital input points
- 16 sourcing 24V DC digital output points

To use 1734 POINT I/O modules as local expansion modules, keep in mind the following:

- Local expansion modules must be installed in the same system as the CompactLogix 5370 L1 controller.
- The modules are installed to the right of the controller.
- The maximum number of local expansion modules available depends on the controller catalog of that system.

[Table 5](#) lists the number of 1734 POINT I/O modules the CompactLogix 5370 L1 controllers support. The minimum RPI of each I/O module is 1.0 ms and can be changed by 0.5 ms increments.

**Table 5 - 1769-L16ER-BB1B, 1769-L18ER-BB1B, 1769-L18ERM-BB1B, 1769-L19ER-BB1B Controllers - Local I/O Module Support**

Cat. No.	Local 1734 POINT I/O Modules Supported, max
1769-L16ER-BB1B	6
1769-L18ER-BB1B	8
1769-L18ERM-BB1B	
1769-L19ER-BB1B	

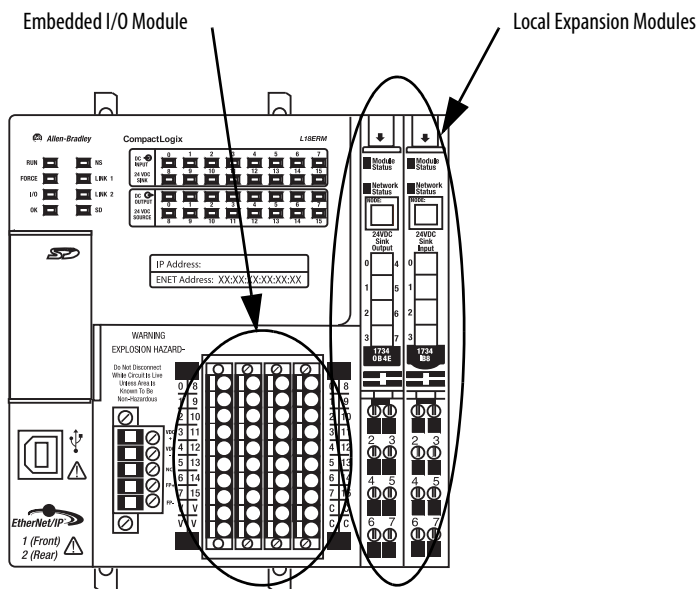

You can use the maximum number of 1734 POINT I/O modules with the CompactLogix 5370 L1 controllers that are listed in [Table 5](#). The total current drawn by the embedded I/O and local expansion modules cannot exceed both the available POINTBus backplane current of 1 A and the field power current of 3 A.

Depending on the configuration of your application, you can use one of the following devices to make additional POINTBus backplane current or field power current available:

- **1734-EP24DC POINT I/O Expansion Power Supply** - An expansion power supply is installed between embedded I/O modules and local expansion modules or between local expansion modules.

The expansion power supply breaks the available POINTBus backplane current between the modules to its left and right. With the expansion power supply installed, the modules to its left can draw up to 1 A of POINTBus backplane current. The modules to the right of the expansion power supply can draw as much current as the current provided by the expansion power supply.

Additionally, the expansion power supply breaks the available field power current between the modules to its left and right. With the expansion power supply installed, the modules to its left can draw up to 3 A of field power current. The modules to the right of the expansion power supply can draw as much field power current as allowed by the expansion power supply.

For more information on the 1734-EP24DC expansion power supply, see the POINT I/O 24V DC Expansion Power Supply Installation Instructions, publication [1734-IN058](#).

- **1734-FPD POINT I/O Field Power Distributor Module** - A field power distributor module can also be installed between embedded I/O modules and local expansion modules or between local expansion modules.

The field power distributor module breaks the available field power current between the modules to its left and right. With the field power distributor module installed, the modules to its left can draw up to 3 A of field power current. The modules to the right of the field power distributor can draw as much field power current as allowed by the field power distributor.

For more information on the 1734-FPD POINT I/O Field Power Distributor module, see the POINT I/O Field Power Distributor Module Installation Instructions, publication [1734-IN059](#).

---

**IMPORTANT** Remember, the field power distributor module changes only the level of field power current available in the system. The module does not affect the level of POINTBus backplane current available.

---

## Local I/O Performance of the CompactLogix 5371 L1 Controllers

The requested packet interval (RPI) defines the frequency at which the controller sends data to and receives data from I/O modules. You set an RPI rate for each I/O module in your system.

CompactLogix 5370 L1 controllers always attempt to scan an I/O module at the configured RPI rate. For individual I/O modules, a Module RPI Overlap minor fault occurs if there are enough I/O modules with RPI rates set too fast that they cannot all be serviced in the allotted interval.

The specific configuration parameters for a system determine the impact on actual RPI rates. These configuration factors can impact the effective scan frequency for any individual module:

- Rates at which the RPI rates of other 1734 POINT I/O module are set
- Number of other 1734 POINT I/O modules in the system
- Types of other 1734 POINT I/O modules in the system
- Application user task priorities

In general, follow these guidelines when setting the RPI rates in a CompactLogix 5370 L1 control system:

- For **digital** modules:
  - 1...2 modules can be scanned in 2 ms.
  - 3...4 modules can be scanned in 4 ms.
  - 5...8 modules can be scanned in 8 ms.

---

**IMPORTANT** When considering digital I/O modules, remember that they can be the embedded I/O module on the controller or 1734 POINT I/O modules that are used as local expansion modules. Therefore, the consideration for using two modules can be the embedded I/O module and a 1734 POINT I/O module or two 1734 POINT I/O modules.

---

- For **specialty and analog** modules (except 1734-485ASC modules):
  - 1 module can be scanned at 20 ms.
  - For each additional module, add 20 ms.For example, if a CompactLogix 5370 L1 control system uses two analog modules, the module can be scanned in 40 ms.
- For **1734-485ASC** modules, the total data size for all ASC modules determines the RPI rates:
  - For total data size less than 20 bytes, each module can be scanned in 20 ms.
  - For data size greater than 20 bytes, use the size value as the RPI.For example, if the total data size is 40 bytes, each ASC module can be scanned in 40 ms.

You are not required to set the RPI values of individual 1734 POINT I/O module to the values listed previously. For example, if your application scans one or two modules, you do not have to use RPI rates of 2 ms. Remember, though, that higher RPI rates result in scanning the data less frequently.

The RPI shows how quickly modules can be scanned, not how quickly an application can use the data. The RPI is asynchronous to the program scan. Other factors, such as program execution duration, affect I/O throughput.

**Table 6 - Embedded DC Input Specifications**

Attribute	1769-L16ER-BB1B, 1769-L18ER-BB1B, 1769-L18ERM-BB1B, 1769-L19ER-BB1B
Inputs	16
Voltage category	24V DC sink
Operating voltage range	10...28.8V DC 24V DC nom
Digital filter, off to on	0.5 ms hardware plus 0...65 ms (user selectable)
Input delay, off to on	
Digital filter, on to off	0.5 ms hardware plus 0...65 ms (user selectable)
Input delay, on to off	
Off-state voltage, max	5V DC
Off-state current, max	1 mA
On-state current, min	2 mA @ 24V DC
Input impedance, max	5.4 k $\Omega$
Cyclic update time	1...750 ms
Isolation voltage	50V DC (continuous), Basic Insulation Type Tested at 500V AC for 60 s, system to field No isolation between individual channels
IEC input compatibility	Type 3
Isolated groups	None

**Table 7 - Embedded DC Output Specifications**

Attribute	1769-L16ER-BB1B, 1769-L18ER-BB1B, 1769-L18ERM-BB1B, 1769-L19ER-BB1B
Outputs	16
Voltage category	24V DC source
Operating voltage range	10...28.8V DC 24V DC nom
Output delay, off to on	0.1 ms
Output delay, on to off	0.1 ms
Off-state leakage current, max	0.5 mA @ 24V DC
On-state current, min	1 mA per channel
On-state voltage drop, max	0.6V DC
Current per point, max	0.5 A
Current per module, max	3 A
Surge current per point, max	1 A for 100 ms per point, repeatable every 2 s
Isolation voltage	50V DC (continuous), Basic Insulation Type Tested at 500V AC for 60 s, system to field No isolation between individual channels
Isolated groups	None
Pilot duty rating	0.5 A

**Table 8 - Embedded Power Supply**

Attribute	1769-L16ER-BB1B, 1769-L18ER-BB1B, 1769-L18ERM-BB1B, 1769-L19ER-BB1B
Input voltage range	10...28.8V DC
Input voltage, nom	24V DC
Line requirement (VDC), min	30VA

**Table 8 - Embedded Power Supply**

Attribute	1769-L16ER-BB1B, 1769-L18ER-BB1B, 1769-L18ERM-BB1B, 1769-L19ER-BB1B
Available 5V DC POINTBus backplane current	1 A @ 5V DC
Current draw @ 24V DC, field power, max	3 A <sup>(1)</sup>
Inrush, max	10 A
Line loss ride through	10 ms... 10 s
Output bus current capacity, max	0.1... 3 A @ 5V DC
Load current, min	300 mA
Power dissipation, max	12 W
Short circuit protection	Internal fuse Not user replaceable
Overvoltage protection	Yes

(1) Combined total for all devices that draw current from field power connections.

## I/O Module Support - CompactLogix 5370 L2 Controllers

The CompactLogix 5370 L2 controllers offer embedded I/O modules and the option to use 1769 Compact I/O modules as local expansion modules. The following table describes the embedded I/O modules and local expansion modules that the CompactLogix 5370 L2 controllers support.

Cat. No.	Embedded I/O Module Support						Local Expansion Modules Support
	Sinking/Sourcing 24V DC Digital Input Points	Sourcing 24V DC Digital Output Points	High-speed Counters	High-speed Counter Output Points	Universal Analog Input Points	Analog Output Points	1769 Compact I/O Modules
1769-L24ER-QB1B	16	16	-	-	-	-	As many as 4 modules
1769-L24ER-QBFC1B			4	4	4	2	
1769-L27ERM-QBFC1B							

**IMPORTANT** Remember the following when using the embedded I/O modules on CompactLogix 5370 L2 controllers:

- 1769-L24ER-QB1B controller - The digital input points and digital output points are on one embedded I/O module. Therefore, the 1769-L24ER-QB1B controller is considered to have one embedded I/O module.
- 1769-L24ER-QBFC1B and 1769-L27ERM-QBFC1B controllers - The digital input points and digital output points are on one embedded I/O module. The high-speed counter input/output points, universal analog input points, and analog output points are on another single embedded I/O module. Therefore, the 1769-L24ER-QBFC1B and 1769-L27ERM-QBFC1B controllers are considered to have two embedded I/O modules.

You configure an RPI rate for the embedded I/O modules to establish specific time intervals at which data is transmitted between the controller and the embedded I/O modules. The available RPI range of the embedded I/O modules is 0.5...750.0 ms and can be changed by 0.5 ms increments. The default setting is 20 ms.

To use 1769 Compact I/O modules as local expansion modules, keep in mind the following:

- Local expansion modules must be installed in the same system as the CompactLogix 5370 L2 controller.
- Local expansion modules are installed to the right of the embedded I/O modules.
- You must install a 1769-ECR Compact I/O end cap on the right side of control system. The end cap can be installed on the right side of the embedded I/O module. If local expansion modules are used, the end cap can be installed on the right side of 1769 Compact I/O module.

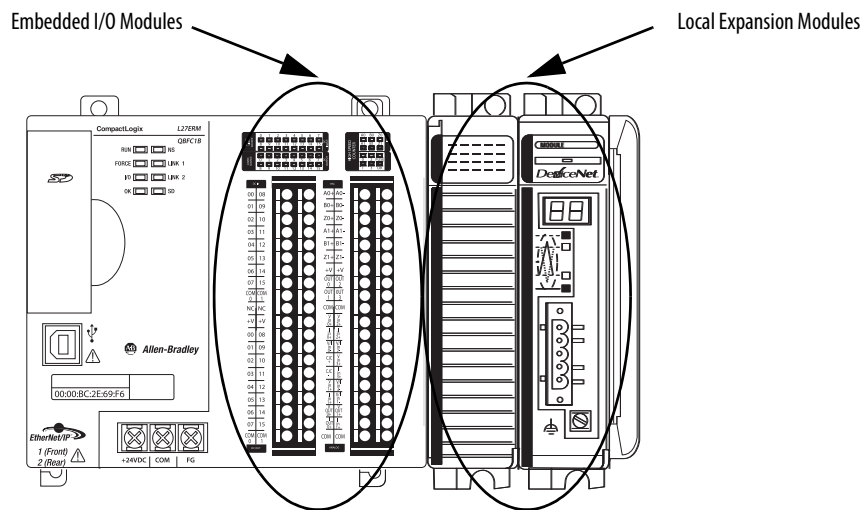

### CompactLogix 5370 L2 Controller Local I/O Performance

The requested packet interval (RPI) defines the frequency at which the controller sends data to and receives data from I/O modules. You set an RPI rate for each I/O module in your system in the programming software. You also set RPI rates through the programming software for embedded I/O modules, local expansion modules, and distributed I/O modules over an EtherNet/IP network.

The CompactLogix 5370 L2 controllers always attempt to scan an I/O module at the configured RPI rate. The controller scans distributed I/O modules at the configured RPI rates.

With embedded I/O modules and local expansion modules, however, some specific system-configuration parameters determine the actual rate at which the controller scans the modules. That is, the controller can be configured to scan an I/O module at one rate, but actually scan the module at another rate.

For individual I/O modules, a Module RPI Overlap minor fault occurs if there is at least one I/O module that cannot be serviced within its RPI time.

The specific configuration parameters for a system determine the impact on actual RPI rates. These configuration factors can impact the effective scan frequency for any individual embedded or local expansion module:

- Rates at which the RPI values of the embedded I/O modules are set
- Number of embedded I/O modules that are used in the system
- Types of embedded I/O modules that are used in the system
- Rates at which RPI values for the 1769 Compact I/O module are set
- Number of 1769 Compact I/O modules in the system
- Types of 1769 Compact I/O modules in the system
- Application user task priorities

[Table 9](#) describes RPI rate guidelines.

**Table 9 - RPI Rate Guidelines**

Type of Module	Guidelines
Digital and analog (any mix)	<p>The following guidelines apply:</p> <ul style="list-style-type: none"> <li>• 1...2 modules can be scanned in 0.5 ms.</li> <li>• 3...4 modules can be scanned in 1 ms.</li> <li>• 5...6 modules can be scanned in 2 ms.</li> <li>• Some input modules have a fixed 8 ms filter, so selecting a faster RPI has no effect.</li> </ul>
Specialty	<p>The following conditions apply:</p> <ul style="list-style-type: none"> <li>• For every full-sized 1769-SDN module in the system, increase the RPI of every other module by 2 ms.</li> <li>• For every 1769-HSC module in the system, increase the RPI of every other module by 1 ms.</li> <li>• For every full-sized 1769-ASCII module system, increase the RPI of every other module by 1 ms.</li> <li>• For every 1769-SM2 module in the system, increase the RPI of every other module by 2 ms.</li> </ul> <p>For example, if the system includes four I/O modules that are configured with an RPI = 1 ms and you add a 1769-SDN module to the system, increase the RPI value for all four I/O modules by 2 ms. Therefore, when the 1769-SDN module is added to the system, the four I/O modules use an RPI = 3 ms. If, in the same system, you add a second 1769-SDN module, the RPI value of the four I/O modules is increased to 5 ms.</p>

**IMPORTANT** The number of I/O modules can be the embedded I/O modules on the controller or 1769 Compact I/O modules that are used as local expansion modules.

Therefore, the consideration for using modules can be any of the following system configurations:

- Only embedded I/O modules
- Only 1769 Compact I/O modules
- Some combination of embedded I/O modules and 1769 Compact I/O modules

You can set individual RPI rates for 1769 Compact I/O modules higher than those values listed in [Table 9](#). The RPI shows how quickly modules can be scanned, not how quickly an application can use the data. The RPI is asynchronous to the program scan. Other factors, such as program execution duration, affect I/O throughput.

**Table 10 - Embedded DC Input Specifications**

Attribute	1769-L24ER-QB1B	1769-L24ER-QBFC1B, 1769-L27ERM-QBFC1B
Inputs	16	
Voltage category	24V DC sink/source	
Operating voltage range	10...28.8V DC @ 40 °C (104 °F) 10...26.4V DC @ 60 °C (140 °F) 24V DC nom	10...28.8V DC @ 40 °C (104 °F) 10...27.0V DC @ 55 °C (131 °F) 10...26.4V DC @ 60 °C (140 °F) 24V DC nom



**Table 10 - Embedded DC Input Specifications**

Attribute	1769-L24ER-QB1B	1769-L24ER-QBFC1B, 1769-L27ERM-QBFC1B
Digital filter, off to on	0 s, 100 $\mu$ s, 500 $\mu$ s, 1 ms, 2 ms, 4 ms, 8 ms	
Input delay, off to on	100 $\mu$ s, min 8 ms, max	
Digital filter, on to off	0 s, 100 $\mu$ s, 500 $\mu$ s, 1 ms, 2 ms, 4 ms, 8 ms	
Input delay, on to off	100 $\mu$ s, min 8 ms, max	
Off-state voltage, max	5V DC	
Off-state current, max	1.5 mA	
On-state current, min	2 mA @ 24V DC per channel	
On-state current, max	5 mA @ 24V DC per channel	
Input impedance, max	5.2 k $\Omega$ @ 24V DC 6.1 k $\Omega$ @ 30V DC	
Cyclic update time	0.5...750 ms	
Isolation voltage	75V (continuous), Reinforced Insulation Type Type tested at 1200V AC for 1 s and at 1700V DC for 1 s; group to system, group to group	
IEC input compatibility	Type 3	
Isolated groups	Group 1: inputs 0...7 Group 2: inputs 8...15 Isolated groups operate in either sink or source configurations	

**Table 11 - Embedded DC Output Specifications**

Attribute	1769-L24ER-QB1B	1769-L24ER-QBFC1B, 1769-L27ERM-QBFC1B
Outputs	16	
Voltage category	24V DC source	
Operating voltage range	20.4...26.4V DC 24V DC nom	
Output delay, off to on	0.05 ms	
Output delay, on to off	0.5 ms	
Off-state leakage current, max	0.1 mA @ 26.4V DC	
On-state current, max	0.5 mA @ 24V DC per channel	
On-state voltage drop, max	1.0V DC @ 1.0 A	
Current per point, max	0.83 A @ 40 °C (104 °F) 0.5 A @ 60 °C (140 °F)	0.83 A @ 40 °C (104 °F) 0.58 A @ 55 °C (131 °F) 0.5 A @ 60 °C (140 °F)
Current per module, max	6.64 A @ 40 °C (104 °F) 4.0 A @ 60 °C (140 °F)	6.64 A @ 40 °C (104 °F) 4.64 A @ 55 °C (131 °F) 4.0 A @ 60 °C (140 °F)
Surge current per point, max	2.0 A for 10 ms per point, repeatable every 2 s	
Isolation voltage	75V (continuous), Reinforced Insulation Type Type tested at 1200V AC for 1 s and at 1700V DC for 1 s; group to system, group to group	
Isolated groups	Group 1: inputs 0...7 Group 2: inputs 8...15	

### Embedded DC Output Temperature Derating

The area within the curves represents the safe operating range for the embedded DC outputs under various conditions of user supplied voltages and ambient temperatures.

**Figure 1 - Embedded DC Outputs Maximum Amperes per Point Versus Temperature**

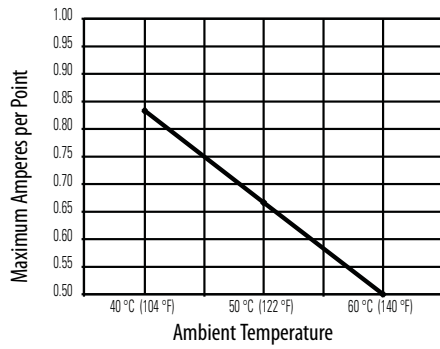

**Figure 2 - Embedded DC Outputs Maximum Amperes per Module Versus Temperature**

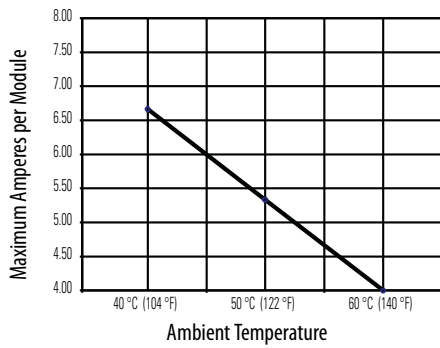

**Table 12 - Embedded Analog Input Specifications**

Attribute	1769-L24ER-QBFC1B, 1769-L27ERM-QBFC1B
Inputs	4 channels of thermocouple/voltage/current 2 channels of RTD/Resistance inputs
Operating voltage range	2.6...30.0V DC @ 40 °C (104 °F) 2.6...26.4V DC @ 55 °C (131 °F) 2.6...5V DC @ 60 °C (140 °F)
Input types	<ul style="list-style-type: none"> <li>• Thermocouple: J, K, T, E, R, S, B, N, and C</li> <li>• Voltage</li> <li>• Current</li> <li>• RTD: Platinum 385, Platinum 3916, Copper 426, Nickel 672, Nickel 618, Nickel-Iron 518</li> <li>• Resistance</li> </ul>
Input ranges <sup>(1)</sup>	<p>Thermocouple:</p> <ul style="list-style-type: none"> <li>• K at 1370...1372 °C (2498...2501.6 °F)</li> <li>• K at -170...1370 °C (-274...2498 °F)</li> <li>• K at -200...1370 °C (-328...2498 °F)</li> <li>• S and R at 0...1768 °C (32...3214.4 °F)</li> <li>• S and R at -50...0 °C (-58...32 °F)</li> <li>• B at 300...1820 °C (572...3308 °F)</li> <li>• B at 250...300 °C (482...572 °F)</li> <li>• J at -210...1200 °C (-328...2192 °F)</li> <li>• T at -170...400 °C (-274...752 °F)</li> <li>• T at -200...-170 °C (-328...-274 °F)</li> <li>• E at -200...1000 °C (-328...1832 °F)</li> <li>• N at -110...1300 °C (-166...2372 °F)</li> <li>• N at -200...-110 °C (-328...-166 °F)</li> <li>• C at 0...2315 °C (32...4199 °F)</li> </ul> <p>Voltage:</p> <ul style="list-style-type: none"> <li>• -50...50 mV</li> <li>• -100...100 mV</li> <li>• 0...5V</li> <li>• 1...5V</li> <li>• 0...10V</li> <li>• -10V...10V</li> </ul> <p>Current:</p> <ul style="list-style-type: none"> <li>• 0...20 mA</li> <li>• 4...20 mA</li> </ul> <p>RTD:</p> <ul style="list-style-type: none"> <li>• 0...100 Ω Platinum 385</li> <li>• 0...200 Ω Platinum 385</li> <li>• 0...500 Ω Platinum 385</li> <li>• 0...1000 Ω Platinum 385</li> <li>• 0...100 Ω Platinum 3916</li> <li>• 0...200 Ω Platinum 3916</li> <li>• 0...500 Ω Platinum 3916</li> <li>• 0...1000 Ω Platinum 3916</li> <li>• 0...10 Ω Copper 426</li> <li>• 0...120 Ω Nickel 618</li> <li>• 0...120 Ω Nickel 672</li> <li>• 0...604 Ω Nickel-Iron 518</li> </ul> <p>Resistance:</p> <ul style="list-style-type: none"> <li>• 0...150 Ω</li> <li>• 0...500 Ω</li> <li>• 0...1000 Ω</li> <li>• 0...3000 Ω</li> </ul>
Resolution, max	15 bits plus sign (Bipolar) 16 bits (Unipolar)
Input impedance	Voltage: 10 MΩ Current: 250 Ω
Converter type	Sigma-Delta
Cyclic update time	11...5000 ms dependent on user configuration
Rated working voltage	30V AC/30V DC
Common mode voltage	±10V DC per channel
Common mode rejection ratio, min	115 dB at 50 Hz at 10V 115 dB at 60 Hz at 10V
Normal mode rejection ratio, min	85 dB at 50 Hz at 1.5V 85 dB at 60 Hz at 1.5V

**Table 12 - Embedded Analog Input Specifications**

Attribute	1769-L24ER-QBFC1B, 1769-L27ERM-QBFC1B
Accuracy, overall at 25 °C (77 °F) <sup>(2)</sup>	<p>Thermocouple types:</p> <ul style="list-style-type: none"> <li>• J at -210...1200 °C (-328...2192 °F): ±0.6 °C (1.1 °F)</li> <li>• N at -110...1300 °C (-166...2372 °F): ±1.0 °C (1.8 °F)</li> <li>• N at -200...-110 °C (-328...-166 °F): ±1.0 °C (1.8 °F)</li> <li>• T at -170...400 °C (-274...752 °F): ±1.0 °C (1.8 °F)</li> <li>• T at -200...-170 °C (-328...-274 °F): ±1.0 °C (1.8 °F)</li> <li>• K at 1370...1372 °C (2498...2501.6 °F): ±1.2 °C (2.2 °F)</li> <li>• K at -200...1370 °C (-328...2498 °F): ±1.0 °C (1.8 °F)</li> <li>• E at -200...1000 °C (-328...1832 °F): ±0.5 °C (0.9 °F)</li> <li>• S and R at 0...1768 °C (32...3214.4 °F): ±1.7 °C (3.1 °F)</li> <li>• S and R at -50...0 °C (-58...32 °F): ±4.0 °C (7.2 °F)</li> <li>• B at 300...1820 °C (572...3308 °F): ±3.0 °C (5.4 °F)</li> <li>• B at 250...300 °C (482...572 °F): ±6.0 °C (10.8 °F)</li> <li>• C at 0...2315 °C (32...4199 °F): ±1.8 °C (3.2 °F)</li> </ul> <p>Voltage inputs:</p> <ul style="list-style-type: none"> <li>• ±50 mV: ±15 µV</li> <li>• ±100 mV: ±20 µV</li> <li>• 0...5V: ±2.5 mV</li> <li>• 1...5V: ±2 mV</li> <li>• 0...10V: ±5 mV</li> <li>• ±10V: ±10 mV</li> </ul> <p>Current inputs:</p> <ul style="list-style-type: none"> <li>• 0...20 mA: ±20 µA</li> <li>• 4...20 mA: ±16 µA</li> </ul> <p>RTD types:</p> <ul style="list-style-type: none"> <li>• Platinum 385: ±0.5 °C (0.9 °F)</li> <li>• Platinum 3916: ±0.4 °C (0.7 °F)</li> <li>• Nickel: ±0.2 °C (0.4 °F)</li> <li>• Nickel-Iron: ±0.3 °C (0.5 °F)</li> <li>• Copper: ±0.6 °C (1.1 °F)</li> </ul> <p>Resistance types:</p> <ul style="list-style-type: none"> <li>• 0...150 Ω: ±0.15 Ω</li> <li>• 0...500 Ω: ±0.5 Ω</li> <li>• 0...1000 Ω: ±1.0 Ω</li> <li>• 0...3000 Ω: ±1.5 Ω</li> </ul>
Accuracy, overall at 0...60 °C (32...140 °F) <sup>(2)</sup>	<p>Thermocouple types:</p> <ul style="list-style-type: none"> <li>• J at -210...1200 °C (-328...2192 °F): ±0.9 °C (1.6 °F)</li> <li>• N at -110...1300 °C (-166...2372 °F): ±1.5 °C (2.7 °F)</li> <li>• N at -200...-110 °C (-328...-166 °F): ±1.5 °C (2.7 °F)</li> <li>• T at -170...400 °C (-274...752 °F): ±1.5 °C (2.7 °F)</li> <li>• T at -200...-170 °C (-328...-274 °F): ±1.5 °C (2.7 °F)</li> <li>• K at 1370...1372 °C (2498...2501.6 °F): ±1.8 °C (3.2 °F)</li> <li>• K at -200...1370 °C (-328...2498 °F): ±1.5 °C (2.7 °F)</li> <li>• E at -200...1000 °C (-328...1832 °F): ±0.8 °C (1.4 °F)</li> <li>• S and R at 0...1768 °C (32...3214.4 °F): ±3.5 °C (6.3 °F)</li> <li>• S and R at -50...0 °C (-58...32 °F): ±4.0 °C (7.2 °F)</li> <li>• B at 300...1820 °C (572...3308 °F): ±4.5 °C (8.1 °F)</li> <li>• B at 250...300 °C (482...572 °F): ±9.0 °C (16.2 °F)</li> <li>• C at 0...2315 °C (32...4199 °F): ±3.5 °C (6.3 °F)</li> </ul> <p>Voltage inputs:</p> <ul style="list-style-type: none"> <li>• ±50 mV: ±25 µV</li> <li>• ±100mV: ±30 µV</li> <li>• 0...5V: ±5 mV</li> <li>• 1...5V: ±4 mV</li> <li>• 0...10V: ±10 mV</li> <li>• ±10V: ±20 mV</li> </ul> <p>Current inputs:</p> <ul style="list-style-type: none"> <li>• 0...20 mA: ±50 µA</li> <li>• 4...20 mA: ±40 µA</li> </ul> <p>RTD types:</p> <ul style="list-style-type: none"> <li>• Platinum 385: ±0.9 °C (1.6 °F)</li> <li>• Platinum 3916: ±0.8 °C (1.4 °F)</li> <li>• Nickel: ±0.4 °C (0.7 °F)</li> <li>• Nickel-Iron: ±0.5 °C (0.9 °F)</li> <li>• Copper: ±1.1 °C (2.0 °F)</li> </ul> <p>Resistance types:<sup>(2)</sup></p> <ul style="list-style-type: none"> <li>• 0...150 Ω: ±0.25 Ω</li> <li>• 0...500 Ω: ±0.8 Ω</li> <li>• 0...1000 Ω: ±1.5 Ω</li> <li>• 0...3000 Ω: ±2.5 Ω</li> </ul>

**Table 12 - Embedded Analog Input Specifications**

Attribute	1769-L24ER-QBFC1B, 1769-L27ERM-QBFC1B
Cold junction compensation accuracy at 0...60 °C (32...140 °F) <sup>(2)</sup>	±1.3 °C (34.34 °F)
Calibration	Cyclic calibration by user configuration
Non-linearity (in percent full scale)	±0.05%
Repeatability at 25 °C (77 °F) with 10 Hz filter	<p>Thermocouple types:</p> <ul style="list-style-type: none"> <li>J at -210...1200 °C (-328...2192 °F): ±0.1 °C (0.2 °F)</li> <li>N at -110...1300 °C (-166...2372 °F): ±0.1 °C (0.2 °F)</li> <li>N at -200...-110 °C (-328...-166 °F): ±0.25 °C (0.5 °F)</li> <li>T at -170...400 °C (-274...752 °F): ±0.1 °C (0.2 °F)</li> <li>T at -200...-170 °C (-328...-274 °F): ±1.5 °C (2.7 °F)</li> <li>K at 1370...1372 °C (2498...2501.6 °F): ±0.15 °C (0.3 °F)</li> <li>K at -170...1370 °C (-274...2498 °F): ±0.1 °C (0.2 °F)</li> <li>K at -200...-170 °C (-328...-274 °F): ±2.0 °C (3.6 °F)</li> <li>E at -200...1000 °C (-328...1832 °F): ±0.1 °C (0.2 °F)</li> <li>S and R at 0...1768 °C (32...3214.4 °F): ±0.4 °C (0.7 °F)</li> <li>S and R at -50...0 °C (-58...32 °F): ±1.0 °C (1.8 °F)</li> <li>B at 300...1820 °C (572...3308 °F): ±0.7 °C (1.3 °F)</li> <li>B at 250...300 °C (482...572 °F): ±1.5 °C (2.7 °F)</li> <li>C at 0...2315 °C (32...4199 °F): ±0.2 °C (0.4 °F)</li> </ul> <p>Voltage inputs:</p> <ul style="list-style-type: none"> <li>±50 mV: ±6 µA</li> <li>±100mV: ±6 µV</li> <li>0...5V: ±150 mV</li> <li>1...5V: ±150 mV</li> <li>0...10V: ±150 mV</li> <li>±10V: ±150 mV</li> </ul> <p>Current inputs:</p> <ul style="list-style-type: none"> <li>0...20 mA: ±0.3 µA</li> <li>4...20 mA: ±0.3 µA</li> </ul> <p>RTD types:</p> <ul style="list-style-type: none"> <li>Platinum 385: ±0.2 °C (0.4 °F)</li> <li>Platinum 3916: ±0.2 °C (0.4 °F)</li> <li>Nickel: ±0.01 °C (0.02 °F)</li> <li>Nickel-Iron: ±0.01 °C (0.02 °F)</li> <li>Copper: ±0.2 °C (0.4 °F)</li> </ul> <p>Resistance types:</p> <ul style="list-style-type: none"> <li>0...150 Ω: ±0.04 Ω</li> <li>0...500 Ω: ±0.2 Ω</li> <li>0...1000 Ω: ±0.2 Ω</li> <li>0...3000 Ω: ±0.2 Ω</li> </ul>
Overload at input terminals, max	Voltage: ±35V DC continuous Current: 32 mA continuous, ±7.6V DC
Channel diagnostics	Invalid configuration, Over- or under-range by bit reporting, open circuit
Isolation voltage	30V AC/30V DC (continuous), reinforced insulation type Type tested at 720V DC for 60 s; inputs to system backplane

(1) Values for these input types rated at the following ambient temperatures: 40 °C (104 °F), 55 °C (131 °F), 60 °C (140 °F).

(2) These specification values are based on cyclic calibration and connecting a 4-wire device to the module.

**Table 13 - Embedded Analog Output Specifications**

Attribute	1769-L24ER-QBFC1B, 1769-L27ERM-QBFC1B
Outputs	2 single-ended
Output types	<ul style="list-style-type: none"> <li>Voltage</li> <li>Current</li> </ul>
Output ranges <sup>(1)</sup>	<p>Voltage:</p> <ul style="list-style-type: none"> <li>0...5V</li> <li>1...5V</li> <li>0...10V</li> <li>-10V...10V</li> </ul> <p>Current:</p> <ul style="list-style-type: none"> <li>0...20 mA</li> <li>4...20 mA</li> </ul>
Converter type	R-2R Ladder Voltage Switching

**Table 13 - Embedded Analog Output Specifications**

Attribute	1769-L24ER-QBFC1B, 1769-L27ERM-QBFC1B
Resolution, max	15 bits plus sign (Bipolar) 16 bits (Unipolar)
Cyclic update time, nom	2.5 ms
Cyclic update time, max	9.5 ms
Current load on voltage output	10 mA max
Resistive load on current output	0...300 Ω
Load range on voltage output	> 1 kΩ at 10V DC
Inductive load, max (current outputs)	0.1 mH
Capacitive load, max (Voltage Outputs)	1 μF
Accuracy, overall at 25 °C (77 °F)	Voltage: ±0.5% full scale Current: ±0.5% full scale
Accuracy, overall at 0...60 °C (32...140 °F)	Voltage: ±0.8% full scale Current: ±0.8% full scale
Accuracy drift with temperature	Voltage: ±0.0086% full scale per °C Current: ±0.0086% full scale per °C
Output ripple range 0...50 kHz (referred to output range)	±0.05%
Non-linearity	±0.05% (in percent full scale)
Repeatability	±0.05%
Output impedance	Voltage: <1 Ω Current: >1 MΩ
Short-circuit protection	Yes
Short-circuit, nom	Current: 16 mA
Open circuit, max	16V
Output response at system powerup and powerdown	Current: ± 1.0V spike for < 5 ms Voltage: ± 1.0V DC spike < 5 ms
Isolation voltage	30V AC/30V DC (continuous), reinforced insulation type Type tested at 500V AC or 710V DC for 60 s; outputs to system backplane

(1) Values for these input types rated at the following ambient temperatures: 40 °C (104 °F), 55 °C (131 °F), 60 °C (140 °F).

**Table 14 - Analog Input Ranges**

Input Type Normal Op. Range	Full Range <sup>(1)</sup>	Raw/Prop. Data Units for Full Range	Eng. Unit Values for Full Range x 1		Eng. Unit Values for Full Range x 10		Scaled-for-PID Values for Normal Operating Range	Scaled-for-PID Values for Full Range	Percent of Normal Op. Range Values	Percent of Full Range Values	
			°C	°F	°C	°F					
-10...10V DC	-10.5V...+10.5V	-32767...+32767	-10500...10500		-1050...1050		0...16,383	-410...16793	-10000...10000	-10500...10500	
0...5V DC	-0.5V...5.25V		-500...5250		-50...525					-1638...17202	-1000...10500
0...10V DC	-0.5V...10.5V		-500...10500		-50...1050					-819...17202	-500...10500
4...20 mA	3.2...21 mA		3200...21000		320...2100					-819...17407	-500...10625

Table 14 - Analog Input Ranges

Input Type Normal Op. Range	Full Range <sup>(1)</sup>	Raw/Prop. Data Units for Full Range	Eng. Unit Values for Full Range x 1		Eng. Unit Values for Full Range x 10		Scaled-for- PID Values for Normal Operating Range	Scaled-for-PID Values for Full Range	Percent of Normal Op. Range Values	Percent of Full Range Values			
			°C	°F	°C	°F							
1...5V DC	0.5V...5.25V	-32767... 32767	500...5250		50...525		0...16,383	-2048...17407	0...10000	-1250... 10625			
0...20 mA	0...21 mA		0...21000		0...2100						0...17202	0...10500	
J (-210...1200)			-2100...12000	-3460...21920	-210...1200	-346...2192					0...16,383	0...10000	0...10000
K (-200...1372)			-2000...13720	-3280...25020	-200...1372	-328...2502							
T (-200...400)			-2000...4000	-3280...7520	-200...400	-328...752							
E (-200...1000)			-2000...10000	-3280...18320	-200...1000	-328...1832							
R (-50...1768)			-500...17680	-580...32140	-50...1768	-58...3214							
S (-50...1768)			-500...17680	-580...32140	-50...1768	-58...3214							
B (250...1820)			2500...18200	4820...32767	250...1820	482...3308							
N (-200...1300)			-2000...13000	-3280...23720	-200...1300	-328...2372							
C (0...2315)			0...23150	320...32767	0...2315	32...4199							
-50...50 mV			-5000...5000		-500...500								
-100...100 mV			-10000...10000		-1000...1000								
0...150 Ω			0...15000		0...1500								
0...500 Ω			0...5000		0...500								
0...1000 Ω			0...10000		0...1000								
0...3000 Ω			0...30000		0...3000								
Platinum 385 (-200...850)			-2000...8500	-3280...15620	-200...850	-328...1562							
Platinum 3916 (-200...510)			-2000...5100	-3280...9500	-200...510	-328...950							
Copper 426 (-70...150)			-700...1500	-940...3020	-70...1500	-94...302							
Nickel 618 (-60...250)		-600...2500	-760...4820	-60...250	-76...482								
Nickel 672 (-80...260)		-800...2600	-1120...5000	-80...260	-112...500								
Nickel-Iron 518 (-100...200)		-1000...2000	-1480...3920	-100...200	-148...392								

(1) Includes amount over and under normal operating.

**Table 15 - Embedded Analog Output Module Data<sup>(1)</sup>**

Analog Output Module Range	Input Value	Example Data		Output Range State	Raw/Proportional Data		Engineering Unit		Scaled-for-PID		Percent Full Range	
		Controller Ordered	Embedded Analog Module Output		Decimal Range		Decimal Range		Decimal Range		Decimal Range	
					Controller Ordered	Embedded Analog Module Output	Controller Ordered	Embedded Analog Module Output	Controller Ordered	Embedded Analog Module Output	Controller Ordered	Embedded Analog Module Output
±10V	Over 10.5V	+11.0V	+10.5V	Over	N/A	N/A	11000		17202		11000	
	+10.5V	+10.5V	+10.5V	Over	32767	32767	10500	10500	16793	16793	10500	10500
	±10V	+10.0V	+10.0V	Normal	31207	31207	10000	10000	16383	16383	10000	10000
		0.0V	0.0V	Normal	0	0	0	0	8192	8192	0	0
	-10.0V	-10.0V	Normal	-31207	-31207	-10000	-10000	0	0	-10000	-10000	
	-10.5V	-10.5V	-10.5V	Under	-32767	-32767	-10500	-10500	-410	-410	-10500	-10500
Under 10.5V	-11.0V	-10.5V	Under	N/A	N/A	-11000	-10500	-819	-410	-11000	-10500	
0...5V	Over 5.25V	5.5V	+5.25V	Over	N/A	N/A	5500	5250	18021	17202	11000	10500
	5.25V	5.25V	+5.25V	Over	32767	32767	5250	5250	17202	17202	10500	10500
	0...5.0V	5.0V	+5.0V	Normal	31207	31207	5000	5000	16383	16383	10000	10000
		0.0V	0.0V	Normal	0	0	0	0	0	0	0	0
	-0.5V	-0.5V	-0.5V	Under	-3121	-3121	-500	-500	-1638	-1638	-1000	-1000
	Under -0.5V	-1.0V	-0.5V	Under	-6241	-3121	-500	-500	-3277	-1638	-2000	-1000
0...10V	Over 10.5V	11.0V	+10.5V	Over	N/A	N/A	11000	10500	18021	17202	11000	10500
	+10.5V	+10.5V	+10.5V	Over	32767	32767	10500	10500	17202	17202	10500	10500
	0...10.0V	+10.0V	+10.0V	Normal	31207	31207	10000	10000	16383	16383	10000	10000
		0.0V	0.0V	Normal	0	0	0	0	0	0	0	0
	-0.5V	-0.5V	-0.5V	Under	-1560	-1560	-500	-500	-819	-819	-500	-500
	Under -5.0V	-1.0V	-0.5V	Under	-3121	-1560	-1000	-500	-1638	-819	-1000	-500
4...20 mA	Over 21.0 mA	+22.0 mA	21 mA	Over	N/A	N/A	22000	21000	18431	17407	11250	10625
	21.0 mA	+21.0 mA	21 mA	Over	32767	32767	21000	21000	17407	17407	10625	10625
	4...20.0 mA	+20.0 mA	20 mA	Normal	31207	31207	20000	20000	16383	16383	10000	10000
		+4.0 mA	+4.0 mA	Normal	6241	6241	4000	4000	0	0	0	0
	3.2 mA	+3.2 mA	+3.2 mA	Under	4993	4993	3200	3200	-819	-819	-500	-500
	Under 3.2	0.0 mA	+3.2 mA	Under	0	4993	0	3200	-4096	-819	-2500	-500
1...5V	Over 5.25V	+5.5V	+5.25V	Over	N/A	N/A	5500	5250	18431	17407	11250	10625
	+5.25V	+5.25V	+5.25V	Over	32767	32767	5250	5250	17407	17407	10625	10625
	1...5.0V	+5.0V	+5.0V	Normal	31207	31207	5000	5000	16383	16383	10000	10000
		+1.0V	+1.0V	Normal	6241	6241	1000	1000	0	0	0	0
	0.5V	+0.5V	+0.5V	Under	3121	3121	500	500	-2048	-2048	-1250	-1250
	Under 0.5V	0.0V	0.0V	Under	0	3121	0	500	-4096	-2048	-2500	-1250
0...20 mA	Over 21.0 mA	+22.0 mA	21 mA	Over	N/A	N/A	22000	21000	18201	17202	11000	10500
	21.0 mA	21.0 mA	21 mA	Over	32767	32767	21000	21000	17202	17202	10500	10500
	0...20.0 mA	20.0 mA	20 mA	Normal	31207	31207	20000	20000	16383	16383	10000	10000
		0.0 mA	0.0 mA	Normal	0	0	0	0	0	0	0	0
	Under 0.0 mA	-1.0 mA	0.0 mA	Under	-1560	0	0	-1000	-819	0	-500	0

(1) If Clamping is enabled, the output value is the clamped value defined in the configuration.



**Table 16 - Embedded HSC Input Specifications**

Attribute	1769-L24ER-QBFC1B, 1769-L27ERM-QBFC1B
Input frequency, max	250 kHz
Input current, max	15 mA per channel
Input current, min	6.8 mA
Input voltage range	2.6...30V DC <sup>(1)</sup>
On-state voltage, max	30V DC
On-state current, min	6.8 mA
Off-state voltage, max	1.0V DC
Off-state current, max	1.5 mA
Off-state leakage current, max	1.5 mA
Input impedance, nom	1950 $\Omega$
Pulse width, min	2.5 $\mu$ s
Phase separation, min	1.3 $\mu$ s
Isolation voltage	75V (continuous), reinforced insulation type Type tested at 1200V AC for 60 s; inputs to system backplane and input to input

(1) See [Maximum Input Voltage - 24V DC Operation](#) temperature derating.

**Table 17 - Embedded HSC Output Specifications**

Attribute	1769-L24ER-QBFC1B, 1769-L27ERM-QBFC1B
Output voltage range	5...30V DC
On-state voltage, max	User power - 0.1V DC
On-state output current, max	0.25 A per channel
On-state output current, min	1 mA
On-state voltage drop, max	0.5V DC
Off-state leakage current, max	5 $\mu$ A
Turn-on time, max	400 $\mu$ s
Turn-off time, max	200 $\mu$ s
Reverse polarity protection	30V DC
Isolation voltage	75V (continuous), reinforced insulation type Type tested at 1200V AC for 60 s; inputs to system backplane and input to input
Current per channel, max	1.0 A @ 40 °C (104 °F) 0.5 A @ 55 °C (131 °F) 0.25 A @ 60 °C (140 °F)
Current per module, max	4.0 A @ 40 °C (104 °F) 2.0 A @ 55 °C (131 °F) 1.0 A @ 60 °C (140 °F)

### Embedded HSC Temperature Derating

**Figure 3 - Maximum Input Voltage - 24V DC Operation**

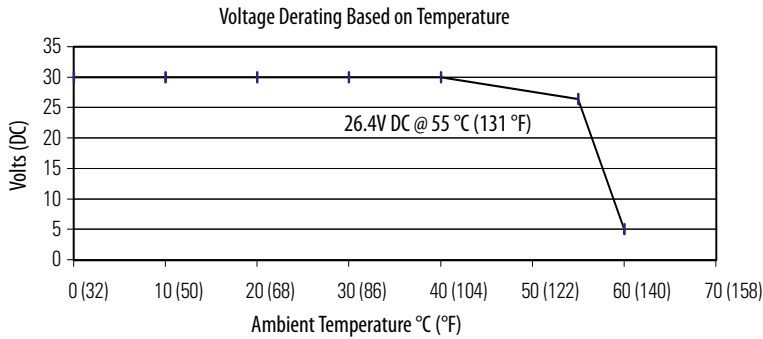

Temperature	Derated Voltage <sup>(1)</sup>
40 °C (104 °F)	30V DC
55 °C (131 °F)	26.4V DC
60 °C (140 °F)	5V DC

(1) Input voltage derating 55...60 °C (131...140 °F) is achieved by using a dropping resistor.  
 For 24V DC input voltage, use a 2.4 kΩ, 1/2 W resistor.  
 For input voltages other than 24V DC, use a 1/2 W resistor with value: 125 x (V<sub>in</sub> - 5V).

**Figure 4 - Maximum Output Voltage - 24V DC Operation**

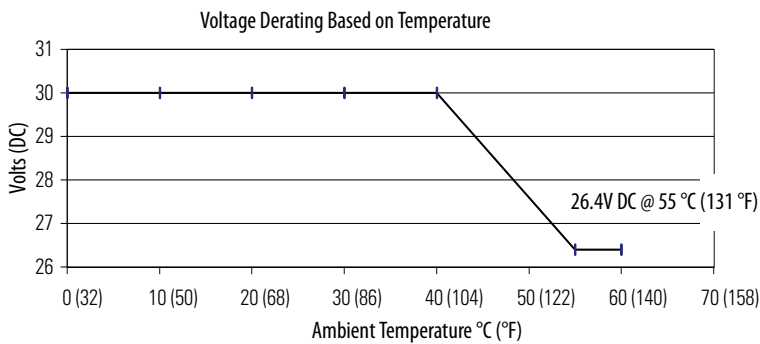

Temperature	Derated Voltage
40 °C (104 °F)	30V DC
55...60 °C (131...140 °F)	26.4V DC

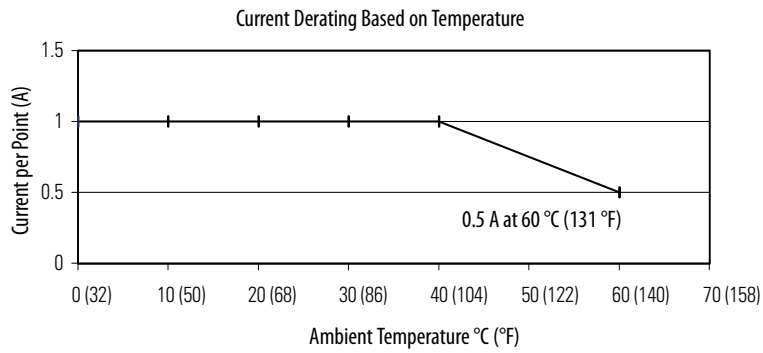
**Figure 5 - Maximum Output Current per Point - 5V DC Operation**

Temperature	Derated Current
0...40 °C (32...104 °F)	1 A
60 °C (140 °F)	0.5 A

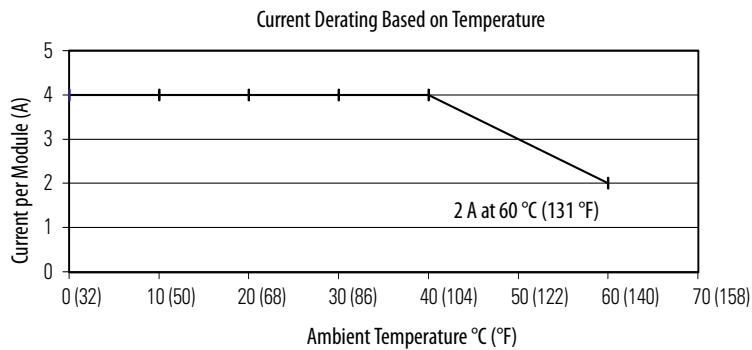
**Figure 6 - Maximum Output Current per Module - 5V DC Operation**

Temperature	Derated Current
0...40 °C (32...104 °F)	4 A
60 °C (140 °F)	2 A

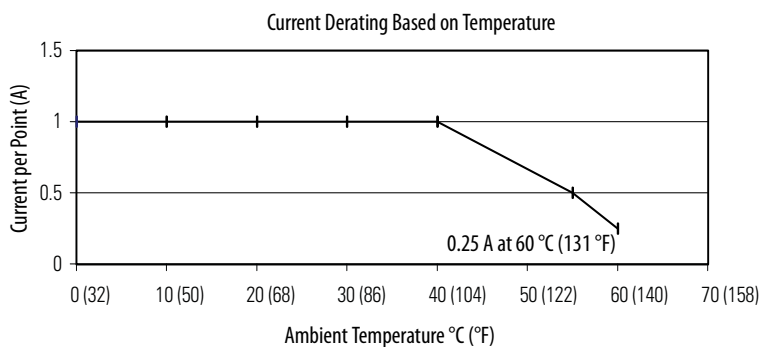
**Figure 7 - Maximum Output Current per Point - 24V DC Operation**

Temperature	Derated Current
0...40 °C (32...104 °F)	1 A
55 °C (131 °F)	0.5 A
60 °C (140 °F)	0.25 A

**Figure 8 - Maximum Output Current per Module - 24V DC Operation**

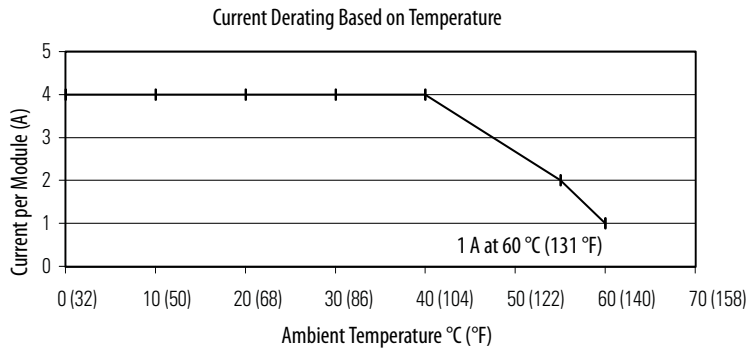

Temperature	Derated Current
40 °C (104 °F)	4 A
55 °C (131 °F)	2 A
60 °C (140 °F)	1 A

**Table 18 - Embedded Power Supply**

Attribute	1769-L24ER-QB1B	1769-L24ER-QBFC1B, 1769-L27ERM-QBFC1B
Input voltage range	19.2...31.2V DC	
Input voltage, nom	24V DC	
Line requirement, max <sup>(1)</sup>	2.1 A @ 24V DC, Class 2/SELV	
Available 5V DC bus current	1.54 A	1.0 A
Available 24V DC bus current	0.95 A	0.8 A
Inrush, max	< 30 A @ 19.2...31.2V DC	
Line loss ride through	10 ms...10 s	
Short circuit protection	Internal fuse Not user replaceable	
Overvoltage protection	Yes	
Isolation voltage	30V AC/30V DC (continuous), reinforced insulation type Type tested at 500V AC or 710V DC for 60 s; outputs to system backplane	

(1) Value rated at the following ambient temperatures: 40 °C (104 °F), 55 °C (131 °F), 60 °C (140 °F).

## I/O Module Support - CompactLogix 5370 L3 and Compact GuardLogix 5370 Controllers

The CompactLogix 5370 L3 controllers offer local expansion modules that are installed across up to three banks of modules. You must use 1769 Compact I/O modules with these controllers.

Remember the following when using I/O modules with the CompactLogix 5370 L3 and Compact GuardLogix 5370 controllers:

- The controller must be the leftmost module in the local bank of the system.
- The number of I/O modules that are supported in a controller system varies by controller catalog number.

Cat. No.	Local 1769 Compact I/O Modules Supported, max
1769-L30ER 1769-L30ERM 1769-L30ERMS 1769-L30ER-NSE	8
1769-L33ER 1769-L33ERM 1769-L33ERMS	16
1769-L36ERM 1769-L36ERMS	30

- You can install I/O modules in as many as three banks, that is, the local bank and two additional banks.
- You can install as many as three I/O modules between the controller and power supply.
- You can install as many as eight I/O modules to the right of the power supply in the local bank.
- You can install as many as eight I/O modules on both the left and right sides of the power supply in additional banks.
- You must consider the distance rating and current draw of the controller and all I/O modules when designing your system.
- Systems with multiple banks can be installed vertically or horizontally.
- You must use expansion cables to connect banks in multi-bank systems.

- You must terminate the end of the last bank in a system.

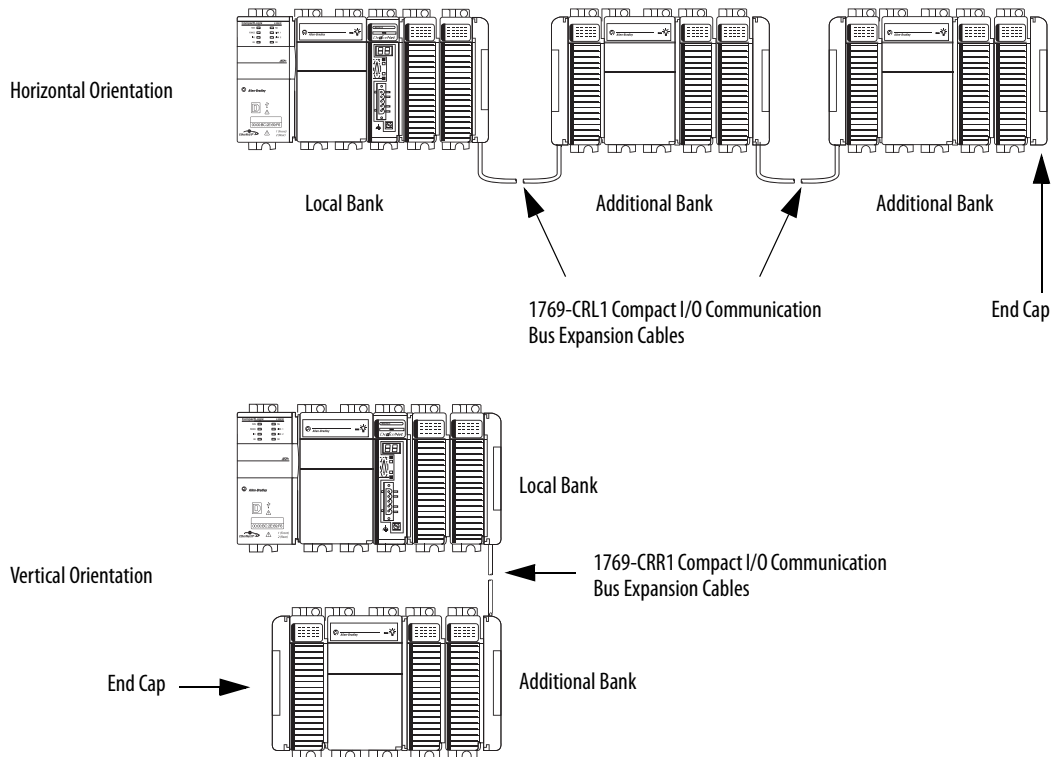

### Local I/O Performance of CompactLogix 5370 L3 Controllers

The requested packet interval (RPI) defines the frequency at which the controller sends data to and receives data from I/O modules. In the programming software, you set an RPI rate for each I/O module in your system.

The CompactLogix 5370 L3 controllers always attempt to scan an I/O module at the configured RPI rate. If there is not enough system bandwidth, that is, if other, higher priority tasks prevent the 1769 Compact I/O subsystem task from completing before the next scheduled time for it to run again, an I/O Task Overlap minor fault occurs. Higher priority tasks that prevent the 1769 Compact I/O subsystem task from completing before the next scheduled time for it to run again use up system bandwidth.

For individual I/O modules, a Module RPI Overlap minor fault occurs if there is at least one I/O module that cannot be serviced within its RPI time.

The specific configuration parameters for a system determine the impact on actual RPI rates. These configuration factors can impact the effective scan frequency for any individual module:

- Rates at which the RPI rates of other 1769 Compact I/O are set
- Number of other 1769 Compact I/O modules in the system
- Types of other 1769 Compact I/O modules in the system
- Application user task priorities

**Table 19 - RPI Rate Guidelines**

Type of Module	Guidelines
1769 Compact I/O digital and analog (any mix) modules	<p>The following guidelines apply:</p> <ul style="list-style-type: none"> <li>• 1...2 modules can be scanned in 0.5 ms.</li> <li>• 3...4 modules can be scanned in 1 ms.</li> <li>• 5...30 modules can be scanned in 2 ms.</li> <li>• Some input modules have a fixed 8 ms filter, so selecting a faster RPI has no effect.</li> </ul>
1769 Compact I/O specialty modules	<p>The following conditions apply:</p> <ul style="list-style-type: none"> <li>• For every full-sized 1769-SDN module in the system, increase the RPI of every other module by 2 ms.</li> <li>• For every 1769-HSC module in the system, increase the RPI of every other module by 1 ms.</li> <li>• For every full-sized 1769-ASCII module system, increase the RPI of every other module by 1 ms.</li> <li>• For every 1769-SM2 module in the system, increase every the RPI of other module by 2 ms.</li> </ul> <p>For example, if there are four digital I/O modules in the system that is configured with an RPI = 1 ms and a 1769-SDN module is added to the system, increase the RPI value for all four digital I/O modules by 2 ms. Therefore, when the 1769-SDN module is added to the system the four digital I/O modules use an RPI = 3 ms.</p> <p>If, in the same system, you add a second 1769-SDN module, the RPI value of the four digital I/O modules is increased to 5 ms.</p>

You can set individual RPI values of 1769 Compact I/O module higher than those values listed in [Table 19](#). For example, if your application scans one or two modules, you do not have to use RPI values = 0.5 ms. You can set the RPI to a higher value, such as 1.0 ms, if necessary. Remember, higher RPI values result in scanning the data less frequently.

The RPI is asynchronous to the program scan. Other factors, such as program execution duration, affect I/O throughput.

**Table 20 - Certifications - CompactLogix 5370 Controllers and Compact GuardLogix 5370 Controllers**

Certification <sup>(1)</sup>	1769-L16ER-BB1B, 1769-L18ER-BB1B, 1769-L18ERM-BB1B, 1769-L19ER-BB1B	1769-L24ER-QB1B, 1769-L24ER-QBFC1B, 1769-L27ERM-QBFC1B	1769-L30ER, 1769-L30ER-NSE, 1769-L30ERM, 1769-L33ER, 1769-L33ERM, 1769-L36ERM	1769-L30ERMS, 1769-L33ERMS, 1769-L36ERMS
c-UL-us	UL Listed Industrial Control Equipment, certified for US and Canada. See UL File E65584. UL Listed for Class I, Division 2 Group A,B,C,D Hazardous Locations, certified for U.S. and Canada. See UL File E194810.			
CE	European Union 2004/108/EC EMC Directive, compliant with: <ul style="list-style-type: none"> <li>EN 61326-1; Meas./Control/Lab., Industrial Requirements</li> <li>EN 61000-6-2; Industrial Immunity</li> <li>EN 61000-6-4; Industrial Emissions</li> <li>EN 61131-2; Programmable Controllers (Clause 8, Zone A &amp; B)</li> </ul>		European Union 2004/108/EC EMC Directive, compliant with: <ul style="list-style-type: none"> <li>EN 61326-1; Meas./Control/Lab., Industrial Requirements</li> <li>EN 61000-6-2; Industrial Immunity</li> <li>EN 61000-6-4; Industrial Emissions</li> <li>EN 61131-2; Programmable Controllers (Clause 8, Zone A &amp; B)</li> <li>EN 60204-1; Electrical equipment of machines</li> <li>EN ISO 13849-1; Safety-related parts of control systems</li> <li>EN 62061; Functional safety of safety-related control systems</li> </ul> European Union 2011/65/EU RoHS, compliant with: EN 50581; Technical documentation	
RCM	Australian Radiocommunications Act, compliant with: <ul style="list-style-type: none"> <li>AS/NZS CISPR 11; Industrial Emissions</li> </ul>			
Ex	European Union 94/9/EC ATEX Directive, compliant with: <ul style="list-style-type: none"> <li>EN 60079-15; Potentially Explosive Atmospheres, Protection "n"</li> <li>EN 60079-0; General Requirements</li> <li>II 3 G Ex nA IIC T4 Gc</li> <li>ITS12ATEX47611X</li> </ul>	European Union 94/9/EC ATEX Directive, compliant with: <ul style="list-style-type: none"> <li>EN 60079-15; Potentially Explosive Atmospheres, Protection "n"</li> <li>EN 60079-0; General Requirements</li> <li>II 3 G Ex nA IIC T4 Gc</li> <li>DEMKO12ATEX 1116807X</li> </ul>	European Union 94/9/EC ATEX Directive, compliant with: <ul style="list-style-type: none"> <li>EN 60079-15; Potentially Explosive Atmospheres, Protection "n"</li> <li>EN 60079-0; General Requirements</li> <li>II 3 G Ex nA IIC T5 Gc X</li> <li>ITS09ATEX46118X</li> </ul>	European Union 94/9/EC ATEX Directive, compliant with: <ul style="list-style-type: none"> <li>EN 60079-15; Potentially Explosive Atmospheres, Protection "n"</li> <li>EN 60079-0; General Requirements</li> <li>II 3 G Ex nA IIC T5 Gc</li> <li>DEMKO 15ATEX1388X</li> </ul>
TÜV	N/A			TÜV Certified for Functional Safety Capable of SIL 3
KC	Korean Registration of Broadcasting and Communications Equipment, compliant with: <ul style="list-style-type: none"> <li>Article 58-2 of Radio Waves Act, Clause 3</li> </ul>			
EAC	Russian Customs Union TR CU 020/2011 EMC Technical Regulation			
EtherNet/IP	ODVA conformance tested to EtherNet/IP specifications.			

(1) When marked. See the Product Certification link at <http://www.ab.com> for Declarations of Conformity, Certificates, and other certification details.



### CompactLogix 5370 L1 Controllers Minimum Spacing Requirements

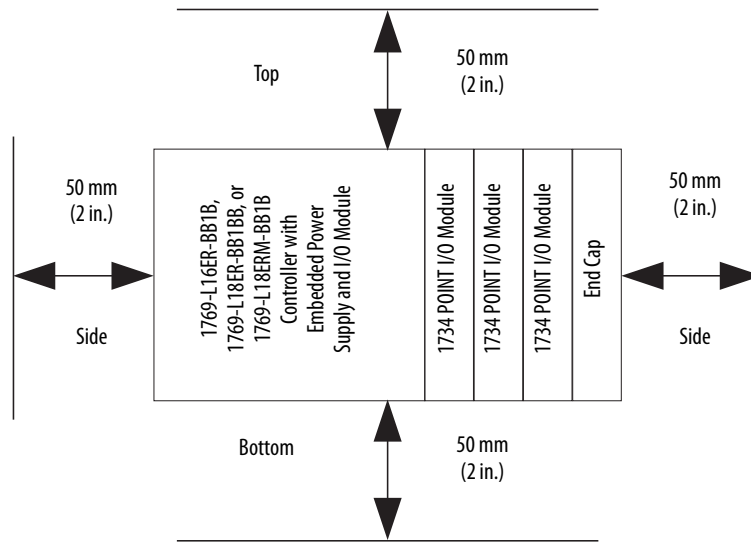

### CompactLogix 5370 L2 Controllers Minimum Spacing Requirements

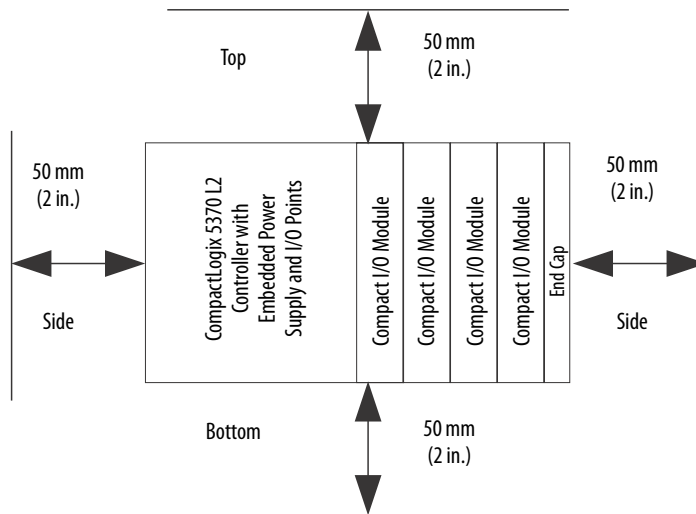

## CompactLogix 5370 L3 and Compact GuardLogix 5370 Controllers Minimum Spacing Requirements

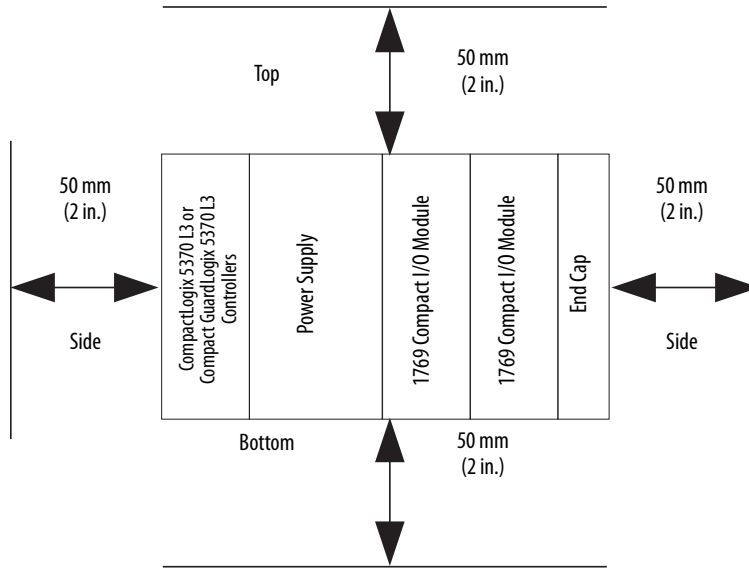

## CompactLogix 5370 L1 Controllers Dimensions

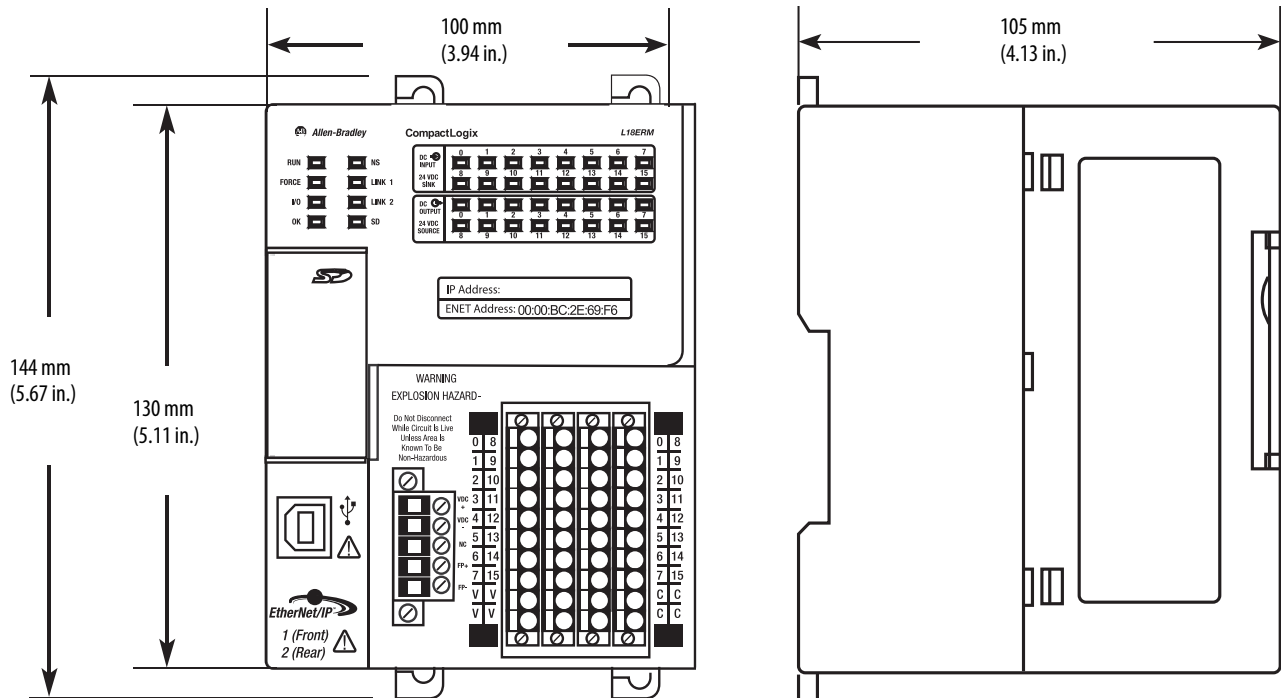



## CompactLogix 5370 L3 Controllers Dimensions

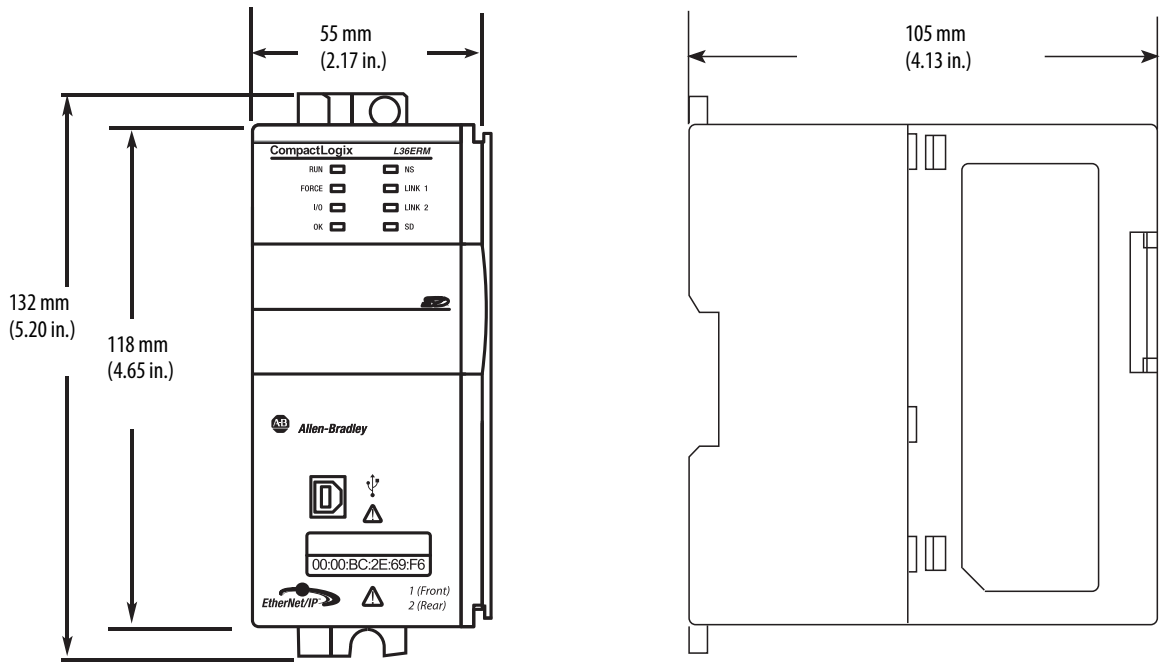

## Compact GuardLogix 5370 Controllers Dimensions

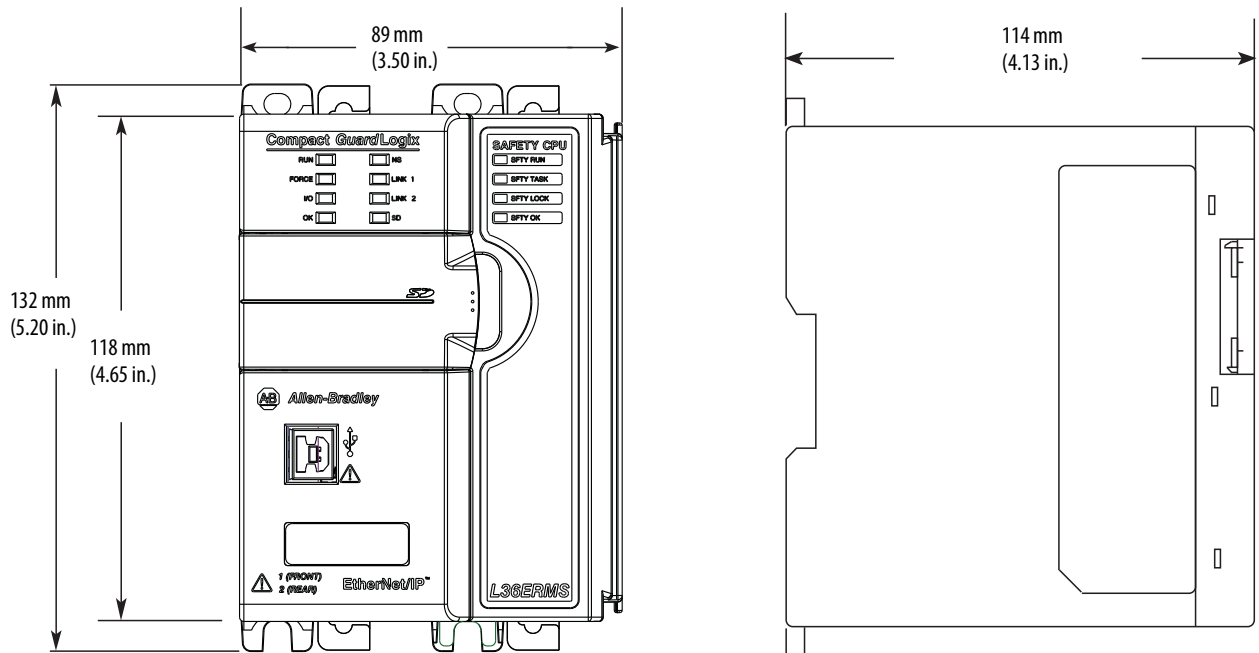

## 1769 Packaged CompactLogix Controllers with Embedded I/O

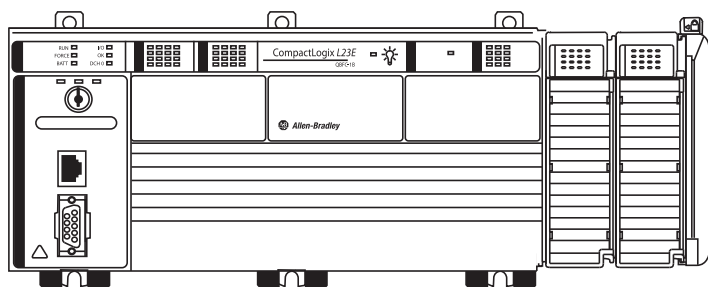

The 1769-L23x controllers provide the following functionality:

- Built-in power supply
- Either two serial ports or one serial and one EtherNet/IP port, depending on controller catalog number
- Combination of embedded digital, analog, and high-speed counter I/O modules
- 1769-ECR right-end cap

**Table 21 - Features - 1769 Packaged CompactLogix Controllers**

Characteristic	1769-L23E-QB1B	1769-L23E-QBFC1B	1769-L23-QBFC1B
Available user memory	512 KB	512 KB	512 KB
CompactFlash card	None	None	None
Communication ports	1 EtherNet/IP port 1 RS-232 serial port (DF1 or ASCII)	1 EtherNet/IP port 1 RS-232 serial port (DF1 or ASCII)	2 RS-232 ports (isolated DF1 or ASCII; only nonisolated DF1)
Embedded I/O	<ul style="list-style-type: none"> <li>• 16 DC inputs</li> <li>• 16 DC outputs</li> </ul>	<ul style="list-style-type: none"> <li>• 16 DC inputs</li> <li>• 16 DC outputs</li> <li>• 4 analog inputs</li> <li>• 2 analog outputs</li> <li>• 4 high-speed counters</li> </ul>	<ul style="list-style-type: none"> <li>• 16 DC inputs</li> <li>• 16 DC outputs</li> <li>• 4 analog inputs</li> <li>• 2 analog outputs</li> <li>• 4 high-speed counters</li> </ul>
Module expansion capacity	Up to three additional 1769 modules	Up to two additional 1769 modules	Up to two additional 1769 modules
Embedded power supply	24V DC	24V DC	24V DC

You can add one or two additional 1769 modules to the right of the controller package. The modules that you can add depend on their current draw. Each packaged controller has the following amount of 5V DC bus current.

**Table 22 - 1769-L23x Available DC Current**

Controller	Available 5V DC Bus Current
1769-L23E-QB1B	1000 mA
1769-L23E-QBFC1B	450 mA
1769-L23-QBFC1B	800 mA

## 1769-L23x Local I/O Performance

The requested packet interval (RPI) defines the frequency at which the controller sends and receives all I/O data on the backplane. The default RPI is 5 ms. The combination of embedded I/O in the packaged controllers determines the fastest RPI you can configure.

Controller	Guideline
1769-L23E-QB1B	1...4 modules can be scanned in 1.0 ms
1769-L23E-QBFC1B 1769-L23-QBFC1B	<ul style="list-style-type: none"> <li>1...4 modules can be scanned in 1.5 ms</li> <li>5...6 modules can be scanned in 2.0 ms</li> </ul>

You can always select an RPI that is slower than listed previously. These considerations show how fast modules can be scanned—not how fast an application can use the data. The RPI is asynchronous to the program scan. Other factors, such as program execution duration, affect I/O throughput.

**Table 23 - Technical Specifications - 1769 Packaged CompactLogix Controllers**

Attribute	1769-L23E-QB1B	1769-L23E-QBFC1B	1769-L23-QBFC1B
User memory	512 KB	512 KB	512 KB
Optional nonvolatile memory	None		
Number of expansion I/O modules, max	3 (limited by current draw of module)	2 (limited by current draw of module)	2 (limited by current draw of module)
Replacement battery	1769-BA		
Current draw @ 5V DC	1000 mA	450 mA	800 mA
Current draw @ 24V DC	700 mA	500 mA	600 mA
Power dissipation	7.01 W	13.58 W	10.73 W
Isolation voltage	30V (continuous), basic insulation type Type tested at 710V DC for 60 s; RS-232 to system backplane, Ethernet to system backplane, and RS-232 to Ethernet		30V (continuous), basic insulation type Type tested at 710V DC for 60 s; RS-232 channel 0 to system backplane, no isolation between RS-232 channel 1 and system
Serial communication ports	CH0 - RS-232 DF1, DH-485, ASCII Fully isolated 38.4 Kbps max		CH0 - RS-232 DF1, DH-485, ASCII Fully isolated 38.4 Kbps max CH1 - RS-232 DF1, DH-485 Nonisolated 38.4 Kbps max
Serial cables	1756-CP3 or 1747-CP3, right angle connector to controller, straight to serial port, 3 m (9.84 ft)		
Weight, approx	0.91 kg (2 lb)	1.22 kg (2.7 lb)	1.22 kg (2.7 lb)
Slot width	1		
Module location	DIN rail or panel mount		
Mounting screw torque	1.1...1.8 N•m (10...16 lb•in) - use M4 or #8 screws		
Wire category <sup>(1)</sup>	2 - on signal ports 2 - on power ports 2 - on communication ports		
Wire type, Ethernet	RJ-45 connector according to IEC 60603-7, 2 or 4 pair Category 5e minimum cable according to TIA 568-B.1 or Category 5 cable according to ISO/IEC 24702		N/A
Wire size, DC power	0.25...2.5 mm <sup>2</sup> (22...14 AWG) solid or stranded copper wire rated at 75 °C (167 °F) or greater, 1.2 mm (3/64 in.) insulation max		
Wire size, discrete I/O connections	0.5...0.8 mm <sup>2</sup> (20...18 AWG) solid or stranded copper wire rated at 75 °C (167 °F) or greater, 1.2 mm (3/64 in.) insulation max		
Wire size, embedded analog and high-speed counter connections	0.5...0.8 mm <sup>2</sup> (20...18 AWG) solid or stranded shielded copper wire rated at 75 °C (167 °F) or greater, 1.2 mm (3/64 in.) insulation max		
North American temperature code	T3C		
Enclosure type rating	None (open-style)		

(1) Use this conductor category information for planning conductor routing. See the Industrial Automation Wiring and Grounding Guidelines, publication [1770-4.1](#).

**Table 24 - Embedded DC Input Specifications**

Attribute	1769-L23E-QB1B, 1769-L23E-QBFC1B, 1769-L23-QBFC1B
Inputs	16 (8 points/group)
Voltage category	24V DC sink/source
Operating voltage range	10...30V DC @ 30 °C (86 °F) 10...26.4V DC @ 60 °C (140 °F)
Digital filter, off to on	0 s, 100 μs, 500 μs, 1 ms, 2 ms
Input delay, off to on	100 μs (typical), 300 μs (max)
Digital filter, on to off	0 s, 100 μs, 500 μs, 1 ms, 2 ms
Input delay, on to off	250 μs (typical), 1 ms (max)
Off-state voltage, max	5V DC
Off-state current, max	1.5 mA
On-state current, min	2 mA @ 10V DC
Inrush current, max	250 mA
Input impedance, max	3 kΩ
Cyclic update time	100 μs...750 ms
Isolation voltage	75V (continuous), basic insulation type Type tested at 1200V AC for 60 s; inputs to system backplane and input group to input group
IEC input compatibility	Type 3
Isolated groups	Group 1: inputs 0...7 Group 2: inputs 8...15 Isolated groups operate in either sink or source configurations

**Table 25 - Embedded DC Output Specifications**

Attribute	1769-L23E-QB1B, 1769-L23E-QBFC1B, 1769-L23-QBFC1B
Outputs	16
Voltage category	24V DC source
Operating voltage range	20.4...26.4V DC
Output delay, off to on	0.1 ms
Output delay, on to off	1.0 ms
Off-state leakage current, max	1.0 mA @ 26.4V DC
On-state current, min	1.0 mA
On-state voltage drop, max	1.0V DC @ 1.0 A
Current per point, max	0.5 A @ 60 °C (140 °F) 1.0 A @ 30 °C (86 °F) Also see the derating graphs
Current per module, max	4.0 A @ 60 °C (140 °F) 8.0 A @ 30 °C (86 °F) Also see the derating graphs on <a href="#">page 40</a>
Surge current per point	2 A for 10 ms per point, repeatable every 2 s
Load current, min	3 mA per point
Isolation voltage	75V (continuous), basic insulation type Type tested at 1200V AC for 60 s; outputs to system backplane
Isolated groups	Group 1: outputs 0...15 (internally connected to common)
Pilot duty rating	0.5 A, 24V DC @ 60 °C (140 °F) 1.0 A, 24V DC @ 30 °C (86 °F)

### Embedded DC Output Temperature Derating

The area within the curves depicts the safe operating range for the embedded DC outputs under various conditions of user supplied voltages and ambient temperatures.

**Figure 9 - Embedded DC Outputs Maximum Amperes per Point Versus Temperature**



**Figure 2 - Embedded DC Outputs Maximum Amperes per Module Versus Temperature**

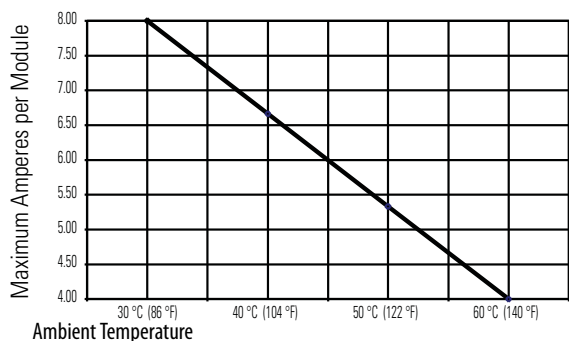

**Table 26 - Embedded Analog Input Specifications**

Attribute	1769-L23E-QB1B, 1769-L23E-QBFC1B, 1769-L23-QBFC1B
Inputs	4 differential or single-ended
Input range	0...10.5V 0...21 mA
Resolution	8 bits plus sign (sign is always positive.)
Input impedance	Voltage: 150 kΩ nom Current: 150 Ω nom
Converter type	Successive approximation
Response speed per channel	5 ms
Rated working voltage	30V AC/30V DC
Common mode voltage	10V DC max per channel
Common mode rejection	Greater than 60 dB at 60 Hz at 10V between inputs and analog common
Normal mode rejection ratio	None
Accuracy, overall at 25 °C (77 °F) <sup>(1)</sup>	Voltage: ±0.7% full scale Current: ±0.6% full scale
Accuracy, overall at 0...60 °C (32...140 °F)	Voltage: ±0.9% full scale Current: ±0.8% full scale
Accuracy drift with temperature	Voltage: ±0.006% per °C Current: ±0.006% per °C



**Table 26 - Embedded Analog Input Specifications**

Attribute	1769-L23E-QB1B, 1769-L23E-QBFC1B, 1769-L23-QBFC1B
Calibration	Not required; components guarantee accuracy
Non-linearity (in percent full scale)	±0.4%
Repeatability	±0.4%
Overload at input terminals, max	Voltage: 20V continuous, 0.1 mA Current: 32 mA continuous, +5V DC
Channel diagnostics	Over-range by bit reporting
Isolation voltage	30V (continuous), basic insulation type Type tested at 500V AC for 60 s; inputs to system backplane and outputs to system backplane

(1) Includes offset, gain, non-linearity, and repeatability error terms.

**Table 27 - Embedded Analog Output Specifications**

Attribute	1769-L23E-QB1B, 1769-L23E-QBFC1B, 1769-L23-QBFC1B
Outputs	2 single-ended
Output range	0...10.5V 0...21 mA
Converter type	Resistor string
Resolution, max	8 bits plus sign (sign is always positive, Bit 15 = 0.)
Response speed per channel	0.3 ms for rated resistance and rated inductance 3.0 ms for rated capacitance
Current load on voltage output	10 mA max
Resistive load on current output	0...300 Ω (includes wire resistance)
Load range on voltage output	> 1 kΩ at 10V DC
Inductive load, max (current outputs)	0.1 mH
Capacitive load, max (Voltage Outputs)	1 μF
Accuracy, overall at 25 °C (77 °F) <sup>(1)</sup>	Voltage: ±0.5% full scale Current: ±0.5% full scale
Accuracy, overall at 0...60 °C (32...140 °F)	Voltage: ±0.6% full scale Current: ±1.0% full scale
Accuracy drift with temperature	Voltage: ±0.01% full scale per °C Current: ±0.01% full scale per °C
Output ripple range 0...50 kHz (referred to output range)	±0.05%
Non-linearity	±0.4% (in percent full scale)
Repeatability	±0.05% (in percent full scale)
Output impedance	10 Ω nom
Open and short-circuit protection	Yes
Short-circuit, max	Current: 40 mA
Open circuit, max	Voltage: 15V
Output response at system powerup and powerdown	+2.0...-1.0V DC spike for less than 6 ms
Isolation voltage	30V (continuous), basic insulation type Type tested at 500V AC for 60 s; inputs to system backplane and outputs to system backplane

(1) Includes offset, gain, drift, non-linearity, and repeatability error terms.

**Table 28 - Embedded HSC Input Specifications**

Attribute	1769-L23E-QB1B, 1769-L23E-QBFC1B, 1769-L23-QBFC1B
Input frequency, max	250 kHz
Input current, max	15 mA
Input current, min	6.8 mA
Input voltage range	-30...30V DC <sup>(1)</sup>
On-state voltage range	2.6...30V DC
On-state current, min	6.8 mA
Off-state voltage, max	1.0V DC
Off-state current, max	1.5 mA
Off-state leakage current, max	1.5 mA
Input impedance, nom	1950 $\Omega$
Pulse width, min	2.5 $\mu$ s
Phase separation, min	1.084 $\mu$ s
Isolation voltage	75V (continuous), basic insulation type Type tested at 1200V AC for 60 s; inputs to system backplane and input to input

(1) See [Maximum Input Voltage - 24V DC Operation](#) temperature derating.

**Table 29 - Embedded HSC Output Specifications**

Attribute	1769-L23E-QB1B, 1769-L23E-QBFC1B, 1769-L23-QBFC1B
Output voltage range	5...30V DC
On-state voltage, max	User power - 0.1V DC
On-state output current, max	1A per point 4A per module
On-state output current, min	1 mA
On-state voltage drop, max	0.5V DC
Off-state leakage current, max	5 $\mu$ A
Turn-on time, max	400 $\mu$ s
Turn-off time, max	200 $\mu$ s
Reverse polarity protection	30V DC
Isolation voltage	75V (continuous), basic insulation type Type tested at 1200V AC for 60 s; inputs to system backplane and input to input

## Embedded HSC Temperature Derating

**Figure 3 - Maximum Input Voltage - 24V DC Operation**

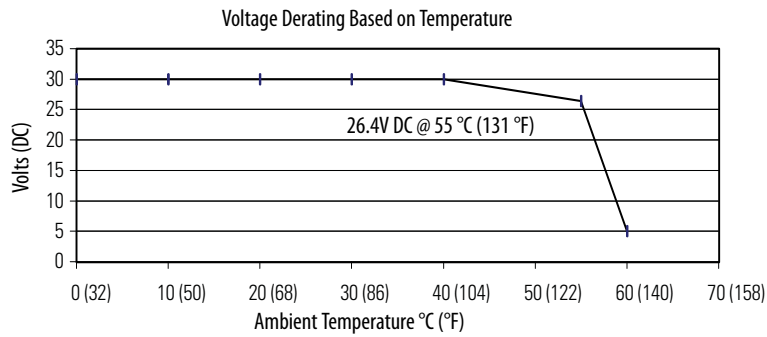

Temperature	Derated Voltage <sup>(1)</sup>
0...40 °C (32...104 °F)	30V DC
55 °C (131 °F)	26.4V DC
60 °C (140 °F)	5V DC

- (1) Input voltage derating 55...60 °C (131...140 °F) is achieved by using a dropping resistor.  
 For 24V DC input voltage, use a 2.4 k $\Omega$ , 1/2 Watt resistor.  
 For input voltages other than 24V DC, use a 1/2 W resistor with value:  $125 \times (V_{in} - 5V)$ .

**Figure 4 - Maximum Output Voltage - 24V DC Operation**

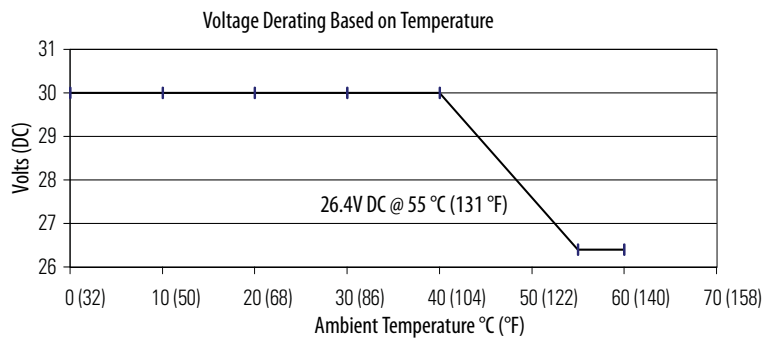

Temperature	Derated Voltage
0...40 °C (32...104 °F)	30V DC
55...60 °C (131...140 °F)	26.4V DC

**Figure 5 - Maximum Output Current per Point - 5V DC Operation**

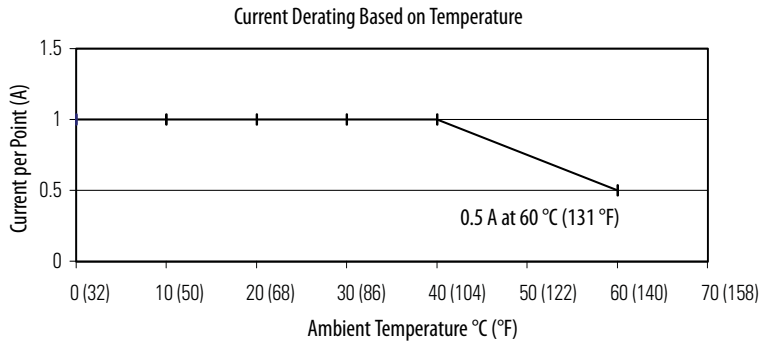

Temperature	Derated Current
0...40 °C (32...104 °F)	1 A
60 °C (140 °F)	0.5 A

**Figure 6 - Maximum Output Current per Module - 5V DC Operation**

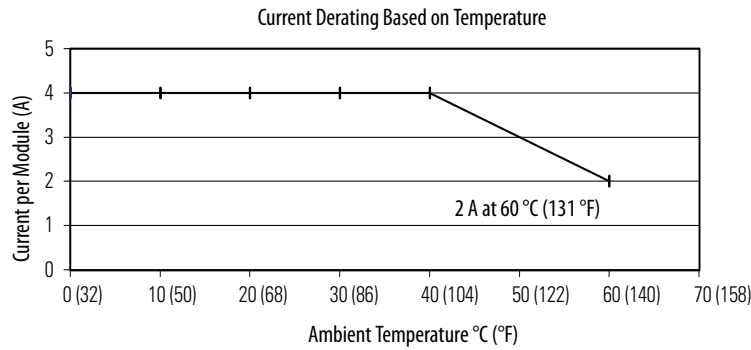

Temperature	Derated Current
0...40 °C (32...104 °F)	4 A
60 °C (140 °F)	2 A

**Figure 7 - Maximum Output Current per Point - 24V DC Operation**

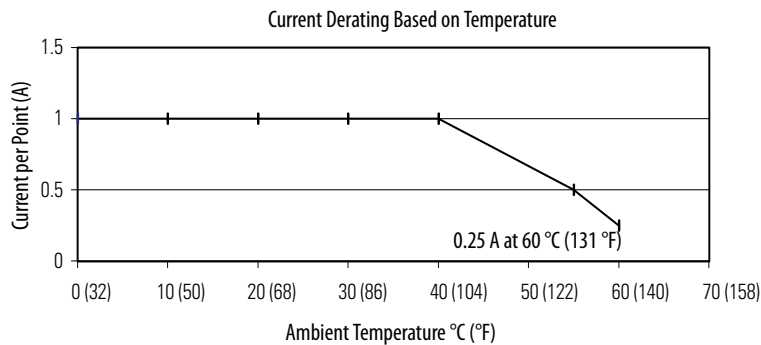

Temperature	Derated Current
0...40 °C (32...104 °F)	1 A
55 °C (131 °F)	0.5 A
60 °C (140 °F)	0.25 A

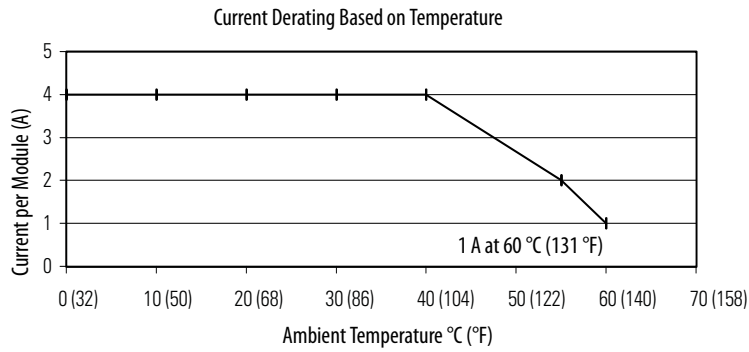
**Figure 8 - Maximum Output Current per Module - 24V DC Operation**

Temperature	Derated Current
0...40 °C (32...104 °F)	4 A
55 °C (131 °F)	2 A
60 °C (140 °F)	1 A

**Table 30 - Embedded Power Supply**

Attribute	1769-L23E-QB1B, 1769-L23E-QBFC1B, 1769-L23-QBFC1B
Input voltage range	19.2...31.2V DC
Input voltage, nom	24V AC
Line requirement, max	50VA at 24V DC
Available 5V DC bus current	1769-L23E-QB1B: 1 A (1000 mA) 1769-L23E-QBFC1B: 450 mA 1769-L23-QBFC1B: 800 mA
Inrush, max	30 A @ 31.2V DC
Line loss ride through	10 ms...10 s
Output bus current capacity	2 A @ 5V DC 0.8 A @ 24V DC See temperature derating graphs
0...55 °C (32...131 °F) 55...60 °C (131...140 °F)	
Load current, min	0 mA @ 5V DC 0 mA @ 24V DC
Short circuit protection	Front access fuse Replacement part number: Wickmann 19193-6.3A
Overvoltage protection	Yes
Isolation voltage	75V (continuous), basic insulation type Type tested at 1200V AC for 60 s; power to system backplane

**Figure 9 - Embedded Power Supply Temperature Derating**

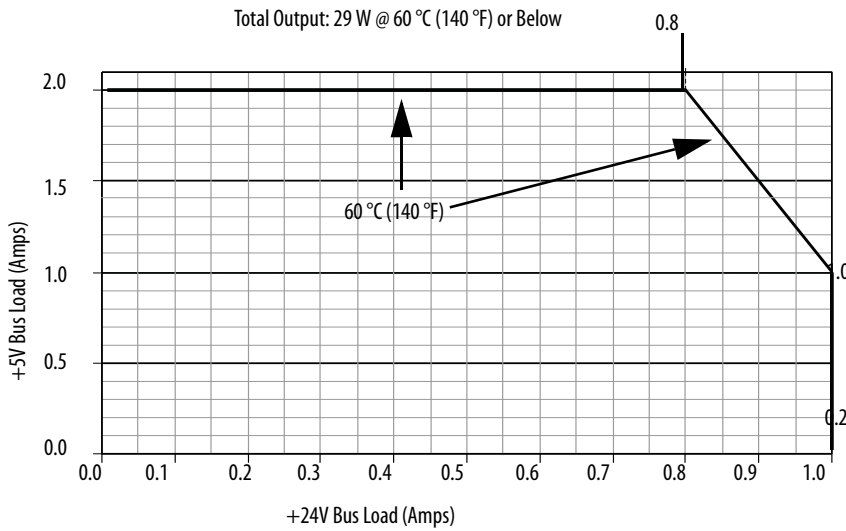
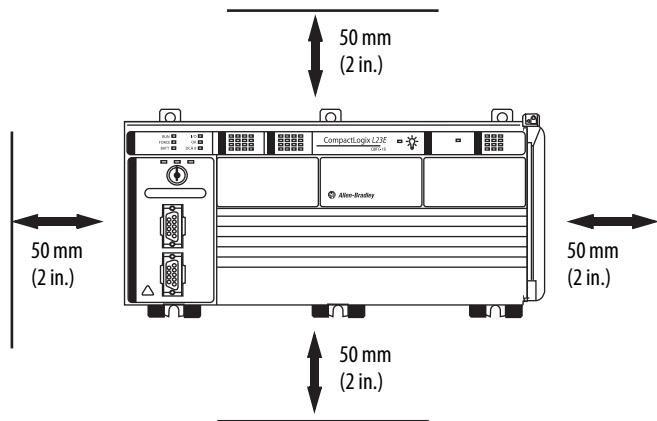

**Table 31 - Certifications - 1769 Packaged CompactLogix Controllers**

Certification <sup>(1)</sup>	1769-L23-QBFC1B, 1769-L23E-QB1B, 1769-L23E-QBFC1B
c-UL-us	UL Listed Industrial Control Equipment, certified for US and Canada. See UL File E65584. UL Listed for Class I, Division 2 Group A,B,C,D Hazardous Locations, certified for U.S. and Canada. See UL File E194810.
CE	European Union 2004/108/EC EMC Directive, compliant with: <ul style="list-style-type: none"> <li>EN 61326-1; Meas./Control/Lab., Industrial Requirements</li> <li>EN 61000-6-2; Industrial Immunity</li> <li>EN 61000-6-4; Industrial Emissions</li> <li>EN 61131-2; Programmable Controllers (Clause 8, Zone A &amp; B)</li> </ul>
RCM	Australian Radiocommunications Act, compliant with: AS/NZS CISPR 11; Industrial Emissions
EtherNet/IP	ODVA conformance tested to EtherNet/IP specifications
KC	Korean Registration of Broadcasting and Communications Equipment, compliant with: <ul style="list-style-type: none"> <li>Article 58-2 of Radio Waves Act, Clause 3</li> </ul>

(1) When marked. See the Product Certification link at <http://www.ab.com> for Declarations of Conformity, Certificates, and other certification details.

**1769-L23x Minimum Spacing Requirements**



### 1769-L23E-QB1B CompactLogix Dimensions

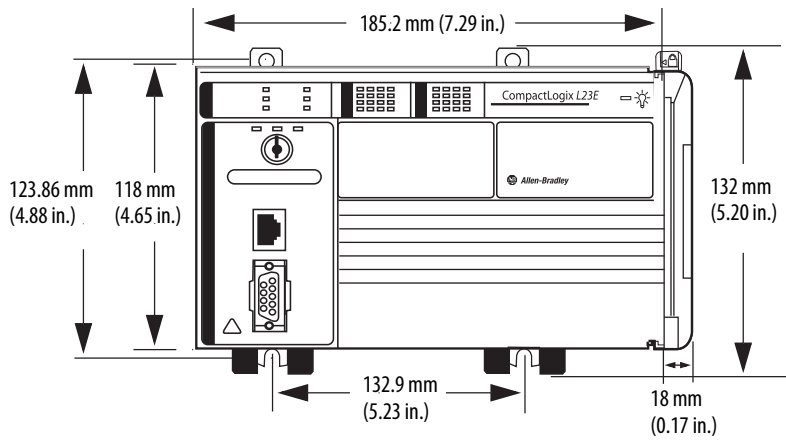

### 1769-L23E-QBFC1B CompactLogix Dimensions

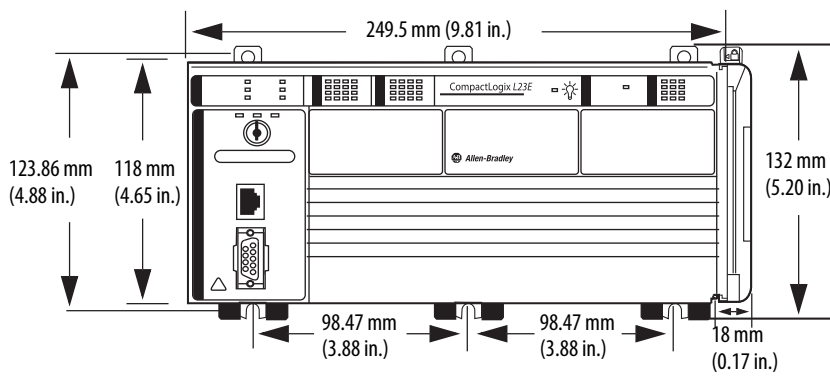

### 1769-L23-QBFC1B CompactLogix Dimensions

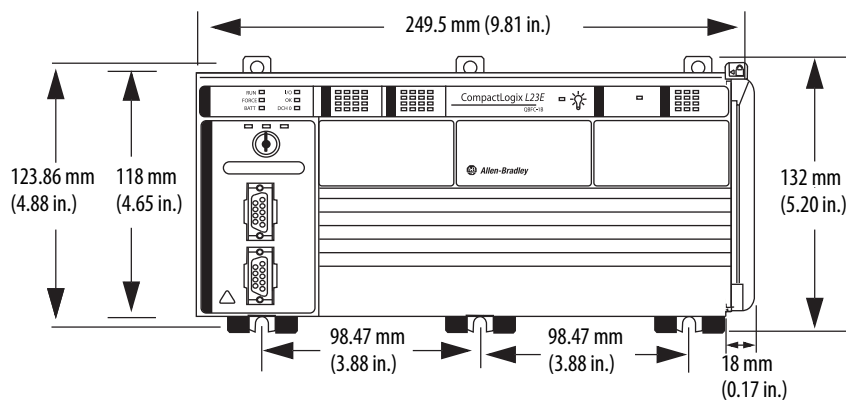

# 1769 Modular CompactLogix Controllers

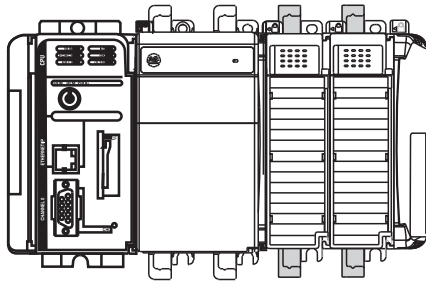

In a 1769-L3x controller system, the 1769 I/O modules can be placed to the left and the right of the power supply. As many as eight modules can be placed on each side of the power supply.

**Table 32 - Features - 1769 Modular CompactLogix Controllers**

Characteristic	1769-L31	1769-L32C	1769-L32E	1769-L35CR	1769-L35E
Available user memory	512 KB	750 KB	750 KB	1.5 MB	1.5 MB
CompactFlash card	1784-CF128	1784-CF128	1784-CF128	1784-CF128	1784-CF128
Communication ports	2 RS-232 ports (isolated DF1 or ASCII; only nonisolated DF1)	1 ControlNet port 1 RS-232 serial port (DF1 or ASCII)	1 EtherNet/IP port 1 RS-232 serial port (DF1 or ASCII)	1 ControlNet port 1 RS-232 serial port (DF1 or ASCII)	1 EtherNet/IP port 1 RS-232 serial port (DF1 or ASCII)
Module expansion capacity	16 1769 modules	16 1769 modules	16 1769 modules	30 1769 modules	30 1769 modules
Power supply distance rating	4 modules	4 modules	4 modules	4 modules	4 modules

The CompactLogix controller has a power supply distance-rating of four modules. The controller must be the leftmost module in the first bank of the system. The maximum configuration for the first bank of a CompactLogix controller is the controller and three I/O modules to the left of the power supply and eight I/O modules to the right of the power supply.

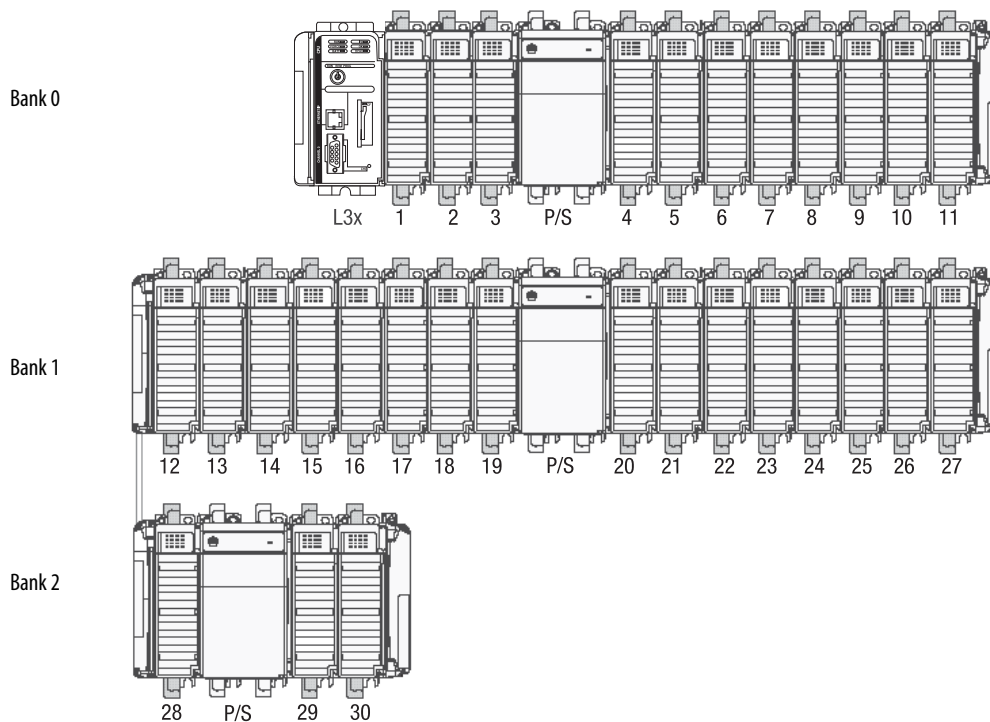



## 1769-L3x Local I/O Performance

You can configure an individual RPI for each local 1769 Compact I/O module. The RPI defines the frequency at which the controller sends and receives all I/O data on the backplane.

Type of Module	Guideline
Digital and analog (any mix)	<ul style="list-style-type: none"> <li>1...4 modules can be scanned in 1 ms</li> <li>5...30 modules can be scanned in 2 ms</li> <li>Some input modules have a fixed 8 ms filter, so selecting a faster RPI has no effect</li> </ul>
Specialty	<ul style="list-style-type: none"> <li>Full-sized 1769-SDN modules add 2 ms per module</li> <li>1769-HSC modules add 1 ms per module</li> <li>Full-sized 1769-ASCII modules add 1 ms per module</li> </ul>

You can always select an RPI that is slower than listed previously. These considerations show how fast modules can be scanned—not how fast an application can use the data. The RPI is asynchronous to the program scan. Other factors, such as program execution duration, affect I/O throughput.

**Table 33 - Technical Specifications - 1769 Modular CompactLogix Controllers**

Attribute	1769-L31	1769-L32C	1769-L32E	1769-L35CR	1769-L35E
User memory	512 KB	750 KB	750 KB	1.5 MB	1.5 MB
Optional nonvolatile memory	1784-CF128				
Number of I/O modules, max	16	16	16	30	30
Number of I/O banks, max	3				
Number of expansion I/O modules, max	16 1769 modules			30 1769 modules	
Replacement battery	1769-BA				
Current draw @ 5V DC	330 mA	650 mA	660 mA	680 mA	660 mA
Current draw @ 24V DC	40 mA	40 mA	90 mA	40 mA	90 mA
Power dissipation	2.61 W	4.21 W	5.5 W	4.36 W	5.5 W
Isolation voltage	30V (continuous), basic insulation type Type tested at 710V DC for 60 s; RS-232 channel 0 to system No isolation between RS-232 channel 1 and system	30V (continuous), basic insulation type Type tested at 710V DC for 60 s; RS-232 to system, ControlNet to system, RS-232 to ControlNet, ControlNet channel A to ControlNet channel B	30V (continuous), basic insulation type Type tested at 710V DC for 60 s; RS-232 to system, Ethernet to system, RS-232 to Ethernet	30V (continuous), basic insulation type Type tested at 710V DC for 60 s; RS-232 to system, ControlNet to system, RS-232 to ControlNet, ControlNet channel A to ControlNet channel B	30V (continuous), basic insulation type Type tested at 710V DC for 60 s; RS-232 to system, Ethernet to system, RS-232 to Ethernet
Communication ports	CH0 - RS-232 DF1, DH-485, ASCII Fully isolated 38.4 Kbps max CH1 - RS-232 DF1, DH-485 Nonisolated 38.4 Kbps max	RS-232 Fully isolated 38.4 Kbps max ControlNet port	RS-232 Fully isolated 38.4 Kbps max EtherNet/IP port 10/100 BASE-T	RS-232 Fully isolated 38.4 Kbps max ControlNet port	RS-232 Fully isolated 38.4 Kbps max EtherNet/IP port 10/100 BASE-T
Serial cables	1756-CP3 or 1747-CP3, right angle connector to controller, straight to serial port, 3 m				
Weight, approx	0.30 kg (0.66 lb)	0.32 kg (0.70 lb)	0.30 kg (0.66 lb)	0.32 kg (0.70 lb)	0.30 kg (0.66 lb)
Slot width	1				
Module location	DIN rail or panel mount				

**Table 33 - Technical Specifications - 1769 Modular CompactLogix Controllers**

Attribute	1769-L31	1769-L32C	1769-L32E	1769-L35CR	1769-L35E
Panel-mounting screw torque	1.1...1.8 N•m (10...16 lb•in) - use M4 or #8 screws				
Power supply distance rating	4 modules				
Power supply	1769-PA2, 1769-PB2, 1769-PA4, 1769-PB4				
Wire category <sup>(1)</sup>	2 - on communication ports				
North American temperature code	T5	T4A			
IEC temperature code	NA	NA	T4	NA	T4
Enclosure type rating	None (open-style)				

(1) Use this conductor category information for planning conductor routing. See the Industrial Automation Wiring and Grounding Guidelines, publication [1770-4.1](#).

**Table 34 - Certifications - 1769 Modular CompactLogix Controllers**

Certification <sup>(1)</sup>	1769-L31	1769-L32C, 1769-L35CR	1769-L32E, 1769-L35E
c-UL-us	UL Listed Industrial Control Equipment, certified for US and Canada. See UL File E65584. UL Listed for Class I, Division 2 Group A,B,C,D Hazardous Locations, certified for U.S. and Canada. See UL File E194810.		
CE	European Union 2004/108/EC EMC Directive, compliant with: <ul style="list-style-type: none"> <li>EN 61326-1; Meas./Control/Lab., Industrial Requirements</li> <li>EN 61000-6-2; Industrial Immunity</li> <li>EN 61000-6-4; Industrial Emissions</li> <li>EN 61131-2; Programmable Controllers (Clause 8, Zone A &amp; B)</li> </ul>		European Union 2004/108/EC EMC Directive, compliant with: <ul style="list-style-type: none"> <li>EN 61000-6-2; Industrial Immunity</li> <li>EN 61000-6-4; Industrial Emissions</li> </ul>
RCM	Australian Radiocommunications Act, compliant with: AS/NZS CISPR 11; Industrial Emissions		
EX	—		European Union 94/9/EC ATEX Directive, compliant with: <ul style="list-style-type: none"> <li>EN 60079-15; Potentially Explosive Atmospheres, Protection 'n'</li> <li>EN 60079-0; General Requirements (Zone 2)</li> <li>II 3 G Ex nA IIC T4 Gc</li> </ul>
CI	—	ControlNet International conformance tested to ControlNet specifications	—
EtherNet/IP	—	—	ODVA conformance tested to EtherNet/IP specifications.
KC	Korean Registration of Broadcasting and Communications Equipment, compliant with: <ul style="list-style-type: none"> <li>Article 58-2 of Radio Waves Act, Clause 3</li> </ul>		

(1) When marked. See the Product Certification link at <http://www.ab.com> for Declarations of Conformity, Certificates, and other certification details.

## Real-time Clock Accuracy

The following table lists the real-time clock accuracy specifications for the 1769 Modular CompactLogix controllers.

Ambient Temperature	Accuracy
0 °C (32 °F)	54...-56 s/mo
25 °C (77 °F)	9...-124 s/mo
40 °C (104 °F)	-84...-234 s/mo
55 °C (131 °F)	-228...-394 s/mo
60 °C (140 °F)	-287...-459 s/mo

## 1769-L3x Minimum Spacing Requirements

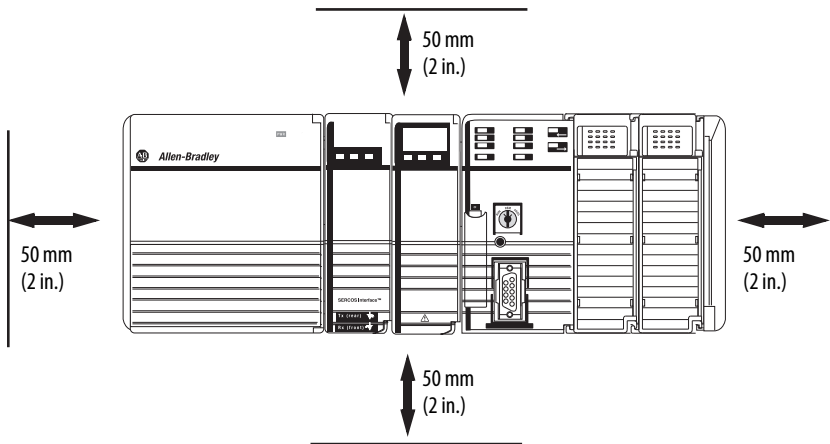

## 1769-L3x CompactLogix Dimensions

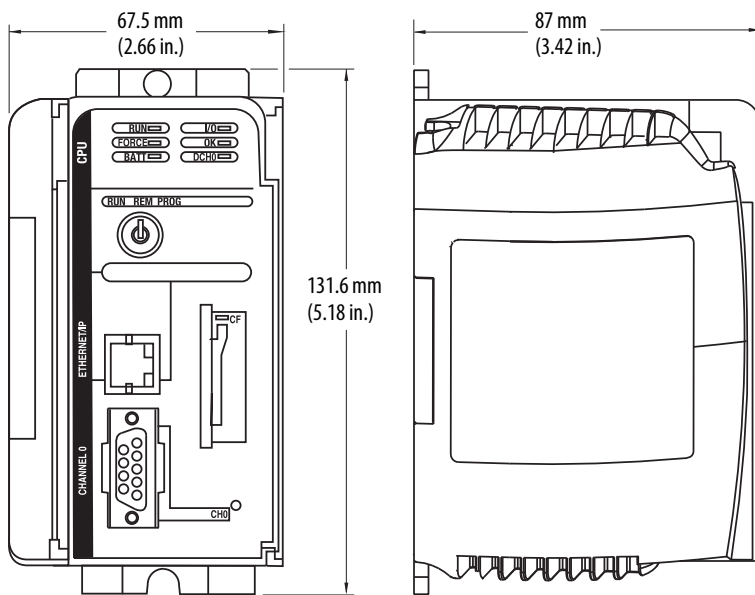

## 1768 CompactLogix Controllers

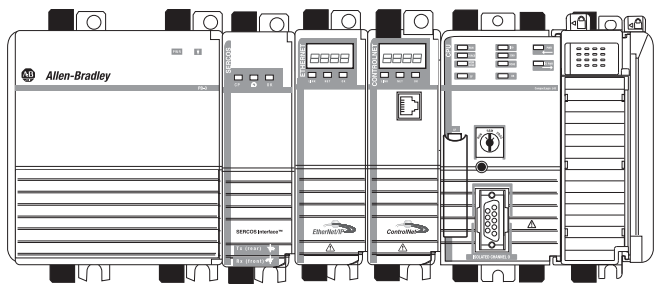

The 1768-L4x controller combines both a 1768 backplane and a 1769 backplane. The 1768 backplane supports the 1768 controller, the 1768 power supply, and a maximum of four 1768 modules. The 1769 backplane supports 1769 modules.

**Table 35 - Features - 1768 CompactLogix Controllers**

Characteristic	1768-L43	1768-L43S	1768-L45	1768-L45S
Available user memory	2 MB	2 MB standard 0.5 MB safety	3 MB	3 MB standard 1 MB safety
CompactFlash card	1784-CF128		1784-CF128	
Communication options	<ul style="list-style-type: none"> <li>EtherNet/IP (standard and safety)</li> <li>ControlNet (standard and safety)</li> <li>DeviceNet (standard)</li> </ul>		<ul style="list-style-type: none"> <li>EtherNet/IP (standard and safety)</li> <li>ControlNet (standard and safety)</li> <li>DeviceNet (standard)</li> </ul>	
Serial communication port	1 RS-232 port		1 RS-232 port	
Module expansion capacity	<ul style="list-style-type: none"> <li>Two 1768 modules</li> <li>Sixteen 1769 modules</li> </ul>		<ul style="list-style-type: none"> <li>Two 1768 modules</li> <li>Thirty 1769 modules</li> </ul>	
Power supply distance rating	—		—	
Programming languages	<ul style="list-style-type: none"> <li>Relay ladder</li> <li>Structured Text</li> <li>Function block</li> <li>Sequential function chart</li> </ul>	<ul style="list-style-type: none"> <li>Standard task: all languages</li> <li>Safety task: relay ladder, safety application instructions</li> </ul>	<ul style="list-style-type: none"> <li>Relay ladder</li> <li>Structured Text</li> <li>Function block</li> <li>Sequential function chart</li> </ul>	<ul style="list-style-type: none"> <li>Standard task: all languages</li> <li>Safety task: relay ladder, safety application instructions</li> </ul>

## Compact GuardLogix Safety System

The Compact GuardLogix controller is a 1768-L4xS CompactLogix controller that provides safety control to achieve SIL 3/PLe according to ISO 13849. A major benefit of this system is that it's still one project, safety and standard together. See [page 5](#) for more information about developing projects with Compact GuardLogix controllers.

## 1768-L4x Placement

In a 1768-L4x controller system, place 1768 modules between the power supply and the controller.

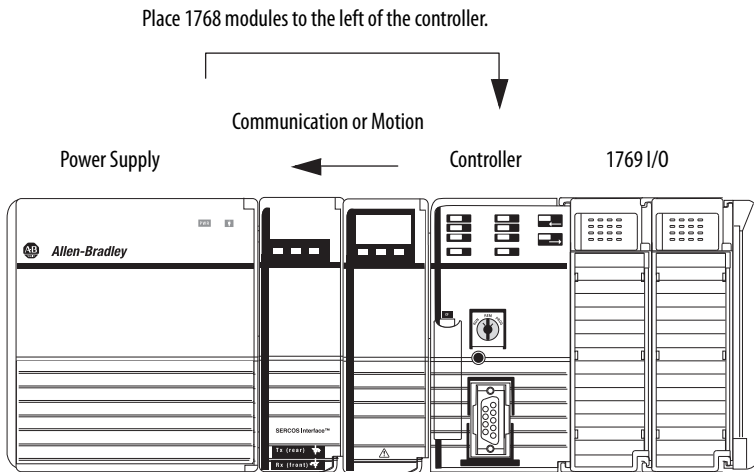

Place 1769 modules to the right of the 1768 backplane:

- As many as eight 1769 modules can be attached to the right of the 1768 system.
- The 1769 I/O connected directly to the 1768 backplane does not need a 1769 power supply.
- Additional 1769 modules must be in additional I/O banks.
- Each additional I/O bank must have its own 1769 power supply.

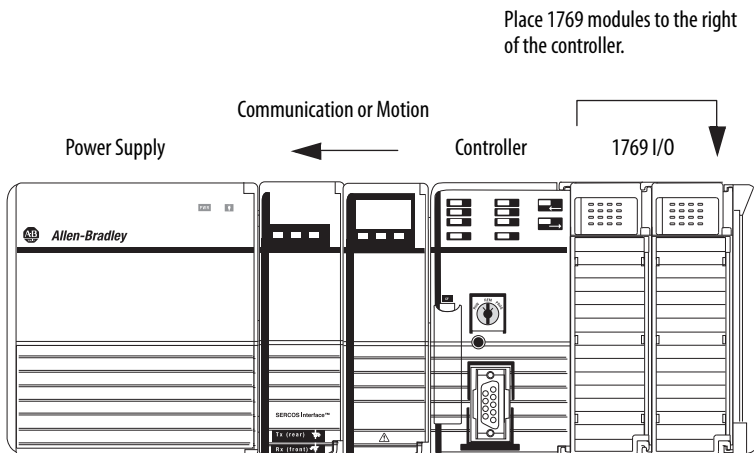

## 1768-L4x Local I/O Performance

Configure an individual RPI for each local 1769 Compact I/O module. Use the default RPI numbers that the programming software automatically assigns or select faster RPI values as fast as 1 ms. I/O module update times do not affect overall 1768 bus performance in the following situations:

- Use faster RPI values for time critical I/O without impacting overall 1769 Compact I/O performance.
- Use Immediate Output (IOT) instructions for further reduction in I/O module update times.

**Table 36 - Technical Specifications - 1768 CompactLogix Controllers**

Attribute	1768-L43	1768-L435	1768-L45	1768-L455
User memory	2 MB	2 MB standard 0.5 MB safety	3 MB	3 MB standard 1 MB safety
Optional nonvolatile memory	1784-CF128			
Number of 1768 modules, max	2		4	
Number of 1768 communication modules, max	2			
Number of 1768 motion modules, max	2		4	
Number of 1769 I/O modules, max	16		30	
Number of I/O banks, max	2		3	
Replacement battery	None needed			
Backplane current draw @ 24V DC	1.3 A	1.4 A	2.0 A	2.1 A
1768 current draw @ 5V DC	2.8 A		5.6 A	
1769 current draw @ 5V DC	2.0 A		2.0 A	
Total 1768 and 1769 current draw @ 5V DC	4.8 A		7.6 A	
Power dissipation	6.3 W	7.5 W	8.3 W	9.5 W
Power consumption	31.3 W	33.6 W	48.0 W	50.4 W
Isolation voltage	30V (continuous), functional insulation type Type tested at 500V AC for 60 s; RS-232 to system			
Communication ports	RS-232 Fully isolated, 38.4 Kbps max			
Serial cables	1756-CP3 or 1747-CP3, right angle connector to controller, straight to serial port, 3 m			
Weight, approx	0.34 kg (11.99 oz)	0.45 kg (15.9 oz)	0.34 kg (11.99 oz)	0.45 kg (15.9 oz)
Dimensions (HxWxD)	131.1 x 56.4 x 121.1 mm (5.18 x 2.22 x 4.81 in.)	131.6 x 89.6 x 122.1 mm (5.18 x 3.53 x 4.81 in.)	131.1 x 56.4 x 121.1 mm (5.18 x 2.22 x 4.81 in.)	131.6 x 89.6 x 122.1 mm (5.18 x 3.53 x 4.81 in.)
Slot width	1	1.5	1	1.5
Module location	DIN rail or panel mount			
Panel-mounting screw torque	1.16 N•m (10 lb•in) - use M4 or #8 screws			
Power supply distance rating	4 modules			
Power supply	1768-PA3, 1768-PB3			
Wire category <sup>(1)</sup>	2 - on communication ports			
IEC temperature code	N/A	T4	N/A	T4
North American temperature code	T4			
Enclosure type rating	None (open-style)			

(1) Use this conductor category information for planning conductor routing as described in the system-level installation manual. See the Industrial Automation Wiring and Grounding Guidelines, publication [1770-4.1](#).

**Figure 10 - 1768-L43 and 1768-L43S Power Dissipation**

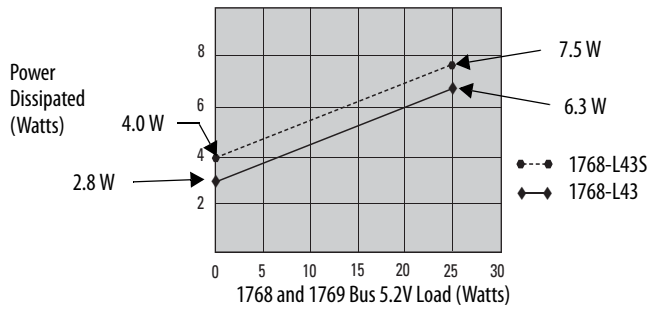

**Figure 11 - 1768-L45 and 1768-L45S Power Dissipation**

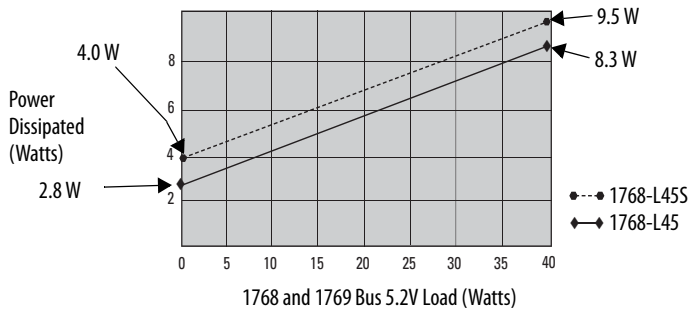

**Table 37 - Certifications - 1768 CompactLogix Controllers**

Certification <sup>(1)</sup>	1768-L43, 1768-L45
c-UL-us	UL Listed Industrial Control Equipment, certified for US and Canada. See UL File E65584. UL Listed for Class I, Division 2 Group A,B,C,D Hazardous Locations, certified for U.S. and Canada. See UL File E194810.
CE	European Union 2004/108/EC EMC Directive, compliant with: <ul style="list-style-type: none"> <li>• EN 61326-1; Meas./Control/Lab., Industrial Requirements</li> <li>• EN 61000-6-2; Industrial Immunity</li> <li>• EN 61000-6-4; Industrial Emissions</li> <li>• EN 61131-2; Programmable Controllers (Clause 8, Zone A &amp; B)</li> </ul>
RCM	Australian Radiocommunications Act, compliant with: AS/NZS CISPR 11; Industrial Emissions
KC	Korean Registration of Broadcasting and Communications Equipment, compliant with: <ul style="list-style-type: none"> <li>• Article 58-2 of Radio Waves Act, Clause 3</li> </ul>

(1) When marked. See the Product Certification link at <http://www.ab.com> for Declarations of Conformity, Certificates, and other certification details.

**Table 38 - Certifications - 1768 Compact GuardLogix Controllers**

Certification <sup>(1)</sup>	1768-L435, 1768-L455
c-UL-us	UL Listed Industrial Control Equipment, certified for US and Canada. See UL File E65584. UL Listed for Class 1, Division 2 Group A,B,C,D Hazardous Locations, certified for U.S. and Canada. See UL File E194810.
CE	European Union 2004/108/EC EMC Directive, compliant with: <ul style="list-style-type: none"> <li>• EN 61326-1; Meas./Control/Lab., Industrial Requirements</li> <li>• EN 61000-6-2; Industrial Immunity</li> <li>• EN 61000-6-4; Industrial Emissions</li> <li>• EN 61131-2; Programmable Controllers (Clause 8, Zone A &amp; B)</li> </ul> European Union 2006/42/EC MD, compliant with: <ul style="list-style-type: none"> <li>• EN 60204-1; Electrical equipment of machines</li> <li>• EN ISO 13849-1; Safety-related parts of control systems</li> <li>• EN 62061; Functional safety of safety-related control systems</li> </ul>
RCM	Australian Radiocommunications Act, compliant with: AS/NZS CISPR 11; Industrial Emissions
Ex	European Union 94/9/EC ATEX Directive, compliant with: <ul style="list-style-type: none"> <li>• EN 60079-15; Potentially Explosive Atmospheres, Protection 'n'</li> <li>• EN60079-0; General Requirements</li> <li>• II 3 G Ex nA nL IIC T4 Gc</li> </ul>
KC	Korean Registration of Broadcasting and Communications Equipment, compliant with: <ul style="list-style-type: none"> <li>• Article 58-2 of Radio Waves Act, Clause 3</li> </ul>
Functional Safety <sup>(2)</sup>	Certified by TÜV: capable of SIL 1 to 3, according to IEC 61508; and PLe/Cat. 4 according to ISO 13849-1

(1) When marked. See the Product Certification link at <http://www.ab.com> for Declarations of Conformity, Certificates, and other certification details.

(2) When used with specified programming software versions.

### 1768-L4x Minimum Spacing Requirements

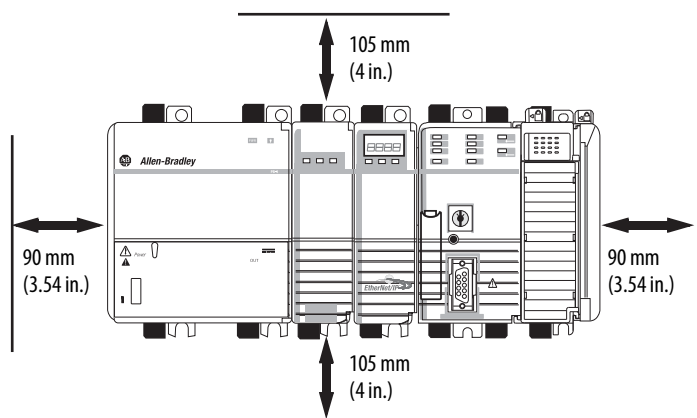



## 1768 Slot Numbering

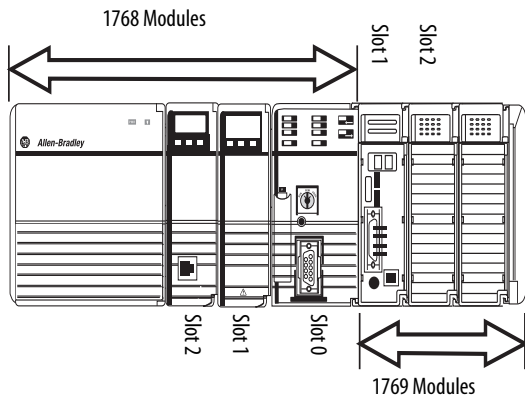

## 1768-L43, 1768-L45 CompactLogix Dimensions

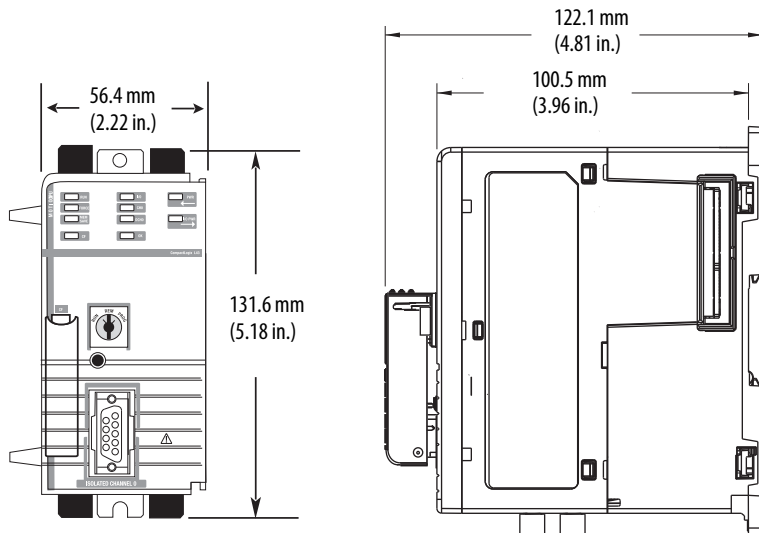

### 1768-L43S, 1768-L45S CompactLogix Dimensions

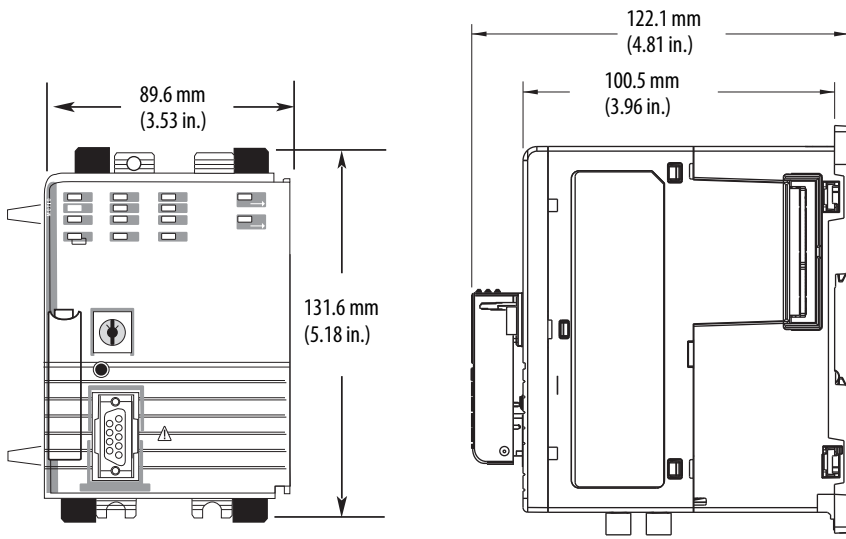

## Controller Memory Use

These equations provide an estimate of the memory that is needed for a controller. These numbers are rough estimates.

Controller tasks	_____ * 4000	=	_____ bytes (minimum 1 task)
Digital I/O points	_____ * 400	=	_____ bytes
Analog I/O points	_____ * 2600	=	_____ bytes
DeviceNet modules <sup>(1)</sup>	_____ * 7400	=	_____ bytes
Other communication modules <sup>(2)</sup>	_____ * 2000	=	_____ bytes
Motion axes	_____ * 8000	=	_____ bytes
FactoryTalk alarm instruction	_____ * 1000	=	_____ bytes (per alarm)
FactoryTalk subscriber	_____ * 10000	=	_____ bytes

(1) The first DeviceNet module is 7400 bytes. Additional DeviceNet modules are 5800 bytes each.

(2) Count all communication modules in the system, not just the modules in the local chassis. This total includes device connection modules, adapters, and ports on PanelView™ terminals.

Reserve 20...30% of the controller memory for future expansion.

## Controller Compatibility

Your controller can control and communicate with other devices, including the following:

- [Control Distributed I/O Modules](#)
- [Control Safety I/O Modules](#)
- [Communicate with Display Devices](#)
- [Communicate with Other Controllers](#)
- [Communicate with Other Communication Devices](#)

### Control Distributed I/O Modules

The controller can control these distributed I/O modules.

I/O Modules	CompactLogix 5370 1768-ENBT 1769-L23Ex 1769-L32E, 1769-L35E EtherNet/IP Network <sup>(1)</sup>	1768-CNB, 1768-CNBR 1769-L32C, 1769-L35CR ControlNet Network	CompactLogix 5370 L2 and L3 1769-SDN DeviceNet Network <sup>(2) (3)</sup>
<b>Chassis-based I/O</b>			
1746 SLC™ I/O	Yes	No	No
1756 ControlLogix® I/O	Yes	Yes	Yes
1769 Compact I/O	No	No	Yes
1771 Universal I/O	No	No	No
<b>In-Cabinet I/O</b>			
1734 POINT I/O	Yes	Yes	Yes
1734D POINTBlock I/O	Yes	Yes	Yes
1790, 1790D, 1790P CompactBlock™ LDX I/O	No	No	Yes
1791D, 1791P, 1791R CompactBlock I/O	No	No	Yes
1794 FLEX™ I/O	Yes	Yes	Yes
1797 FLEX Ex™ I/O	Yes	Yes	No
<b>On-Machine I/O</b>			
1732 ArmorBlock® I/O	Yes	No	Yes
1738 ArmorPOINT® I/O	Yes	Yes	No
1792D ArmorBlock MaXum™ I/O	No	No	Yes
1799 Embedded I/O	No	No	Yes

(1) A non-EtherNet/IP CompactLogix controller requires a 1761-NET-ENI interface to connect to an EtherNet/IP network. This interface is only a messaging bridge.

(2) To control I/O, use a 1769-SDN scanner to connect the controller to the DeviceNet network.

(3) The 1769-SDN does not support safety communication to Guard I/O modules on a DeviceNet network.

## Control Safety I/O Modules

The Compact GuardLogix controller can control these safety I/O modules in a safety system.

I/O Modules	EtherNet/IP	ControlNet
1791ES CompactBlock Guard I/O	Yes	No
1734 POINT Guard I/O	Yes	No

## Communicate with Display Devices

The controller can communicate with these display devices.

Display Devices	EtherNet/IP Network <sup>(1)</sup>	ControlNet Network	DeviceNet Network <sup>(2)</sup>	RS-232 (DF1) Network	DH-485 Network
<b>Industrial Computers</b>					
Allen-Bradley® industrial computers (all) <sup>(3)</sup>	Yes	Yes	Yes	Yes	Yes
<b>Graphic Terminals</b>					
PanelView Plus and PanelView CE terminals	Yes	Yes	Yes	Yes	Yes
PanelView standard terminals	Yes	Yes	Yes	Yes	Yes
PanelView e terminals	No	No	No	No	No
<b>Message Displays</b>					
InView™ message displays	Yes	Yes	Yes	Yes	Yes

(1) A non-EtherNet/IP CompactLogix controller requires a 1761-NET-ENI interface to connect to an EtherNet/IP network. This interface is only a messaging bridge.

(2) For DeviceNet access, use either a 1769-SDN scanner (control I/O and send/receive messages) or a 1761-NET-DNI interface (messaging bridge).

(3) Includes: Allen-Bradley-integrated display rotating media (HDD) and solid-state (SSD) computers, Allen-Bradley non-display computers, and Allen-Bradley-integrated display computers with keypad.

## Communicate with Other Controllers

The controller can communicate with these programmable controllers.

Controller	EtherNet/IP Network <sup>(1)</sup>	ControlNet Network	DeviceNet Network <sup>(2)</sup>	RS-232 (DF1) Network	DH-485 Network
1756 ControlLogix 1756 GuardLogix	Yes	Yes	Yes	Yes	Yes
CompactLogix 5370	Yes	No	Yes <sup>(3)</sup>	Yes <sup>(4)</sup>	Yes <sup>(5)</sup>
1768-L4x CompactLogix	Yes	Yes	Yes	Yes	Yes
1769-L3x CompactLogix	Yes	Yes	Yes	Yes	Yes
1769-L23x CompactLogix	Yes	No	Yes	Yes	Yes
1789 SoftLogix™ 5800	Yes	Yes	Yes	Yes	No
1794 FlexLogix™	Yes	Yes	Yes	Yes	Yes
PowerFlex® with DriveLogix™	Yes	Yes	Yes	Yes	Yes
1785 PLC-5®	Yes <sup>(6) (7)</sup>	Yes	Yes <sup>(8)</sup>	Yes	—
1747 SLC	Yes <sup>(9)</sup>	Yes	Yes <sup>(4)</sup>	Yes	Yes
1761 MicroLogix™	Yes	No	Yes <sup>(4)</sup>	Yes	Yes
1762 MicroLogix	Yes	No	Yes <sup>(4)</sup>	Yes	Yes

Controller	EtherNet/IP Network <sup>(1)</sup>	ControlNet Network	DeviceNet Network <sup>(2)</sup>	RS-232 (DF1) Network	DH-485 Network
1763 MicroLogix	Yes	No	Yes <sup>(4)</sup>	Yes	Yes
1764 MicroLogix	Yes	No	Yes <sup>(4)</sup>	Yes	Yes
1772 PLC-2 <sup>®</sup>	—	—	—	Yes	—
1775 PLC-3 <sup>®</sup>	—	—	—	Yes	—
5250 PLC-5/250	—	—	No	Yes	—

- (1) A non-EtherNet/IP controller requires a 1761-NET-ENI interface to connect to an EtherNet/IP network. This interface is only a messaging bridge.
- (2) In the CompactLogix system, use either a 1769-SDN scanner (control I/O and send/receive messages) or a 1761-NET-DNI interface (messaging bridge).
- (3) The CompactLogix 5370 L1 controllers cannot access a DeviceNet network and, therefore, cannot communicate with other controllers on a DeviceNet network.
- (4) The CompactLogix 5370 controllers do not have an embedded serial port. You must add external modules to communicate over an RS-232 (DF1) network.
- (5) The CompactLogix 5370 controllers do not have an embedded serial port. You must add external modules to communicate over a DH-485 network.
- (6) The Ethernet PLC-5 controller must be series C, firmware revision N.1 or later; series D, firmware revision E.1 or later; or series E, firmware revision D.1 or later.
- (7) The 1785-ENET Ethernet communication interface module must be series A, firmware revision D or later.
- (8) The PLC-5, SLC, and MicroLogix processors appear as I/O points to the Logix controller. Use the appropriate DeviceNet interface for the controller.
- (9) Use a 1747-L55x controller with 05501 or later.

## Communicate with Other Communication Devices

The controller can communicate with these communication devices.

Communication Device	EtherNet/IP Network <sup>(1)</sup>	ControlNet Network	DeviceNet Network <sup>(2)</sup>
Linking device (only ControlLogix controllers)	1788-EN2DN	1788-CN2DN 1788-CN2FF	1788-EN2DN <sup>(3)</sup> 1788-CN2DN
PCMCIA card	—	1784-PCC	1784-PCD
PCI card	—	1784-PCIC 1784-PCICS	1784-PCID 1784-PCIDS 1784-CPCIDS
Drives SCANport™ module	—	1203-FM1 1203-FB1 <sup>(4)</sup>	—
Communication module	—	1203-CN <sup>(5)</sup> 1770-KFC15 1770-KFCD15 1747-KFC15	1770-KFD 1770-KFG
Communication card	—	1784-PKTCS 1784-KTCS 1784-KTCX15	1784-PKTX 1784-PKTXD
USB communication device	—	1784-U2CN	1784-U2DN

- (1) A non-EtherNet/IP controller requires a 1761-NET-ENI interface to connect to an EtherNet/IP network. This interface is only a messaging bridge.
- (2) In the CompactLogix system, use either a 1769-SDN scanner (control I/O and send/receive messages) or a 1761-NET-DNI interface (messaging bridge).
- (3) The 1788-EN2DN does not support safety communication (CIP Safety).
- (4) Use a CIP generic MSG instruction to communicate with the 1203-FM1 SCANport module on a DIN rail that is remote to the controller. The remote DIN rail also requires a 1794-ACN15 or 1794-ACNR15 ControlNet adapter.
- (5) Use the generic module configuration to configure the 1203-CN1 module and a CIP generic MSG instruction to communicate with the module.

## Controller Connections

A CompactLogix system uses the connection types to establish communication links between devices:

- Controller-to-local I/O modules or local communication modules
- Controller-to-remote I/O or remote communication modules
- Controller-to-remote I/O (rack-optimized) modules
- Produced and consumed tags
- Messages
- Controller access by the programming software
- Controller access by RSLinx® Classic software for HMI or other applications

You indirectly determine the number of connections the controller uses by configuring the controller to communicate with other devices in the system. The limit of connections can ultimately reside in the communication module you use for the connection. If a message path routes through a communication module, the connection that is related to the message also counts toward the connection limit of that communication module.

### CompactLogix 5370 Controller Ethernet Node Limits and Connections

When designing a CompactLogix 5370 control system, you must consider the following:

- Maximum number of Ethernet nodes available for the project of your controller
- Connections

The controller that you select determines the number of Ethernet nodes available.

Cat. No.	Ethernet Nodes Supported
1769-L16ER-BB1B	4
1769-L18ER-BB1B	8
1769-L18ERM-BB1B	
1769-L19ER-BB1B	
1769-L24ER-QB1B	
1769-L24ER-QBFC1B	8
1769-L27ERM-QBFC1B	
1769-L30ER	16
1769-L30ERM	
1769-L30ER-NSE	
1769-L33ER	32
1769-L33ERM	
1769-L36ERM	48

All CompactLogix 5370 controllers support 256 CIP connections and 120 TCP/IP connections.

## 1769-L23x CompactLogix Connections

The controller that you select determines the connections for I/O and messages.

Controller	Supports
1769-L23EQB1B	32 CIP connections 8 TCP/IP connections
1769-L23EQBFC1B	

The total connection requirements for a 1769 CompactLogix system include both local and remote (distributed) connections. The controller supports 100 connections. The available remote connections depend on the network interface.

## 1769-L3x CompactLogix Connections

The controller that you select determines the connections for I/O and messages.

Controller	Supports
1769-L32C 1769-L35CR	32 CIP connections
1769-L32E 1769-L35E	32 CIP connections 32 TCP/IP connections

The total connection requirements for a 1769 CompactLogix system include both local and remote (distributed) connections. The controller supports 100 connections. The available remote connections depend on the network interface.

## 1768-L4x CompactLogix Connections

The communication module that you select determines the connections for I/O and messages.

Communication Module	Supports
1768-ENBT 1768-EWEB	128 CIP connections 64 TCP/IP connections
1768-CNB 1768-CNBR	48 CIP connections

The total connection requirements for a 1768 CompactLogix system include both local and remote (distributed) connections. The controller supports 250 connections. The available remote connections depend on the network interface.



## Determine Total Connection Use

The total connection requirements for a CompactLogix system include both local and remote (distributed) connections. The controllers support these numbers of connections:

- 1769-L23x and 1769-L3x controllers support 100 connections.
- 1768-L4x controllers support 250 connections.
- CompactLogix 5370 controllers support 256 connections.

The available remote connections depend on the network interface.

Connection Type	Device Quantity	Connections per Device	Total Connections
Remote ControlNet communication module Configured as a direct (none) connection Configured as a rack-optimized connection		0 or 1	
Remote I/O module over a ControlNet network (direct connection)		1	
Remote Ethernet communication module Configured as a direct (none) connection Configured as a rack-optimized connection		0 or 1	
Remote I/O module over an EtherNet/IP network (direct connection)		1	
Remote device over a DeviceNet network (accounted for in rack-optimized connection for local 1756-DNB module)		0	
Produced tag and first consumer Each additional consumer		2 1	
Consumed tag		1	
Cached message		1	
Message		1	
RSLinx Enterprise subscriber (16 maximum)		1	
<b>Total</b>			

## CompactLogix Controller Accessories

### Memory Cards

Memory cards offer nonvolatile memory to store a user program and tag data on a controller. Through the programming software, you can manually trigger the controller to save to or load from nonvolatile memory or configure the controller to load from nonvolatile memory on powerup.

---

**IMPORTANT** The 1769-L23x packaged CompactLogix controllers do not offer a nonvolatile memory option.

---

The CompactLogix 5370 controllers come with a 1784-SD1 Secure Digital (SD) card installed. You can order a 1784-SD2 SD card separately for additional nonvolatile memory with the CompactLogix 5370 controllers.

The 1768-L4x and 1769-L3x modular CompactLogix controllers offer a CompactFlash card as a nonvolatile memory option. You install the CompactFlash card in a socket on the controller. Through the programming software, you can manually trigger the controller to save to or load from nonvolatile memory or configure the controller to load from nonvolatile memory on powerup.

**Table 39 - Technical Specifications - 1784-CF128, 1784-SD1, 1784-SD2**

Attribute	1784-CF128	1784-SD1	1784-SD2
Memory	128 MB	1 GB	2 GB
Supported controllers	1769 modular controllers 1768 controllers	CompactLogix 5370 controllers	
Weight, approx	14.2 g (0.5 oz)	1.76 g (0.062 oz)	

**Table 40 - Environmental Specifications - 1784-CF128, 1784-SD1, 1784-SD2**

Attribute	1784-CF128, 1784-SD1, 1784-SD2
Temperature, operating IEC 60068-2-1 (Test Ad, Operating Cold), IEC 60068-2-2 (Test Bd, Operating Dry Heat), IEC 60068-2-14 (Test Nb, Operating Thermal Shock)	-25...70 °C (-13...158 °F)
Temperature, storage IEC 60068-2-1 (Test Ab, Unpackaged Nonoperating Cold), IEC 60068-2-2 (Test Bb, Unpackaged Nonoperating Dry Heat), IEC 60068-2-14 (Test Na, Unpackaged Nonoperating Thermal Shock)	-40...85 °C (-40...185 °F)
Relative humidity IEC 60068-2-30 (Test Db, Unpackaged Damp Heat)	5...95% noncondensing
Vibration IEC 60068-2-6 (Test Fc, Operating)	2 g @ 10...500 Hz
Shock, operating IEC 60068-2-27 (Test Ea, Unpackaged Shock)	30 g
Shock, nonoperating IEC 60068-2-27 (Test Ea, Unpackaged Shock)	50 g
Emissions CISPR 11	Group 1, Class A
ESD immunity IEC 61000-4-2	6 kV contact discharges 8 kV air discharges
Radiated RF immunity IEC 61000-4-3	10V/m with 1 kHz sine-wave 80% AM from 80...2000 MHz 10V/m with 200 Hz 50% Pulse 100% AM @ 900 MHz 10V/m with 200 Hz 50% Pulse 100% AM @ 1890 MHz 3V/m with 1 kHz sine-wave 80% AM from 2000...2700 MHz

**Table 41 - Certifications - 1784 Memory Cards**

Certification <sup>(1)</sup>	1784-CF128, 1784-SD1, 1784-SD2
CE	European Union 2004/108/EC EMC Directive, compliant with: <ul style="list-style-type: none"> <li>EN 61000-6-4; Industrial Emissions</li> <li>EN 61326-1; Meas./Control/Lab., Industrial Requirements</li> <li>EN 61000-6-2; Industrial Immunity</li> <li>EN 61131-2; Programmable Controllers (Clause 8, Zone A &amp; B)</li> </ul>
RCM	Australian Radiocommunications Act, compliant with: AS/NZS CISPR 11; Industrial Emissions
KC	Korean Registration of Broadcasting and Communications Equipment, compliant with: <ul style="list-style-type: none"> <li>Article 58-2 of Radio Waves Act, Clause 3</li> </ul>

(1) When marked. See the Product Certification link at <http://www.ab.com> for Declarations of Conformity, Certificates, and other certification details.

## 1769 CompactLogix Batteries

The 1769-L23x and 1769-L3x controllers come with one 1769-BA lithium battery.

The 1768 controllers and the CompactLogix 5370 controllers do not require a battery. The controller uses internal nonvolatile memory to store its program during shutdown. Energy that is stored in the system maintains controller power long enough to store the program to internal nonvolatile memory, but not the external CompactFlash card nor SD card respectively.

**Table 42 - Technical Specifications - 1769-BA**

Attribute	1769-BA
Description	Lithium battery (0.59 g)
CompactLogix controllers	1769-L23-QBFC1B, 1769-L23E-QB1B, 1769-L23E-QBFC1B 1769-L31 1769-L32C, 1769-L35CR 1769-L32E, 1769-L35E

## Removable Terminal Kits

You can order removable terminal kits with the CompactLogix 5370 L1 and L2 controllers separately. The kits are used to connect wiring to the controllers. [Table 43](#) describes the kits.

**Table 43 - CompactLogix 5370 Controllers Removable Terminal Kits**

Cat. No.	Controllers Supported	Description
1769-RTB45	CompactLogix 5370 L1	<ul style="list-style-type: none"> <li>Four 10-pin connectors are used to connect wiring to the embedded digital I/O module of the controller.</li> <li>One 5-pin connector is used to connect an external 24V DC power source to the controller.</li> </ul>
1769-RTB40DIO	CompactLogix 5370 L2	Four 10-pin connectors are used to connect wiring to the embedded digital I/O module of the controller.
1769-RTB40AIO	1769-L24ER-QBFC1B and 1769-L27ERM-QBFC1B	Four 10-pin connectors are used to connect wiring to the embedded analog I/O module of the controller.

## Cold Junction Compensation

The CompactLogix 5370 L2 controllers require the use of the 1769-CJC CompactLogix CJC Sensor when the embedded analog input of the controller is configured for Thermocouple mode.

## Ethernet Communication Cables

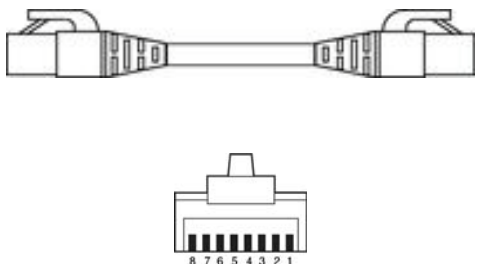

Connector Number	Color	1585J-M8xBJM-2	1585J-M4TBJM-2
1	White/Orange	TxData +	
2	Orange	TxData -	
3	White/Green	Recv Data +	
4	Blue	Unused	-
5	White/Blue	Unused	-
6	Green	Recv Data -	
7	White/Brown	Unused	-
8	Brown	Unused	-

Attribute	Value
Connector type	RJ45 Male to RJ45 Male
Connector angle	Straight-through
Length	Varies by catalog number

## Serial Communication Cables

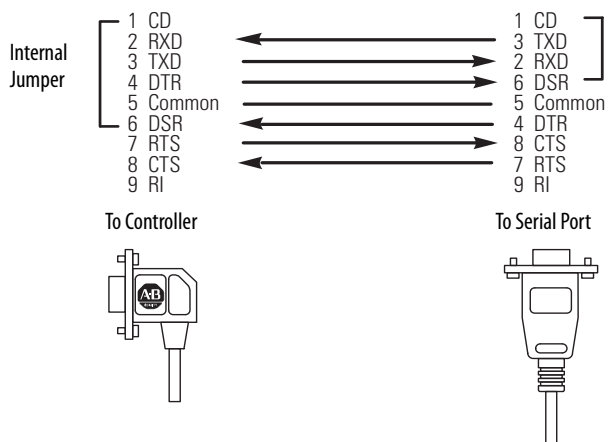

Attribute	1756-CP3	1747-CP3
Connector type	Female 9-pin D-shell	
Connector angle	Right angle connector to controller, straight to serial port	
Length	3 m (118 in.)	

**Notes:**

**Notes:**

**Notes:**

## Important User Information

Read this document and the documents listed in the additional resources section about installation, configuration, and operation of this equipment before you install, configure, operate, or maintain this product. Users are required to familiarize themselves with installation and wiring instructions in addition to requirements of all applicable codes, laws, and standards.

Activities including installation, adjustments, putting into service, use, assembly, disassembly, and maintenance are required to be carried out by suitably trained personnel in accordance with applicable code of practice.

If this equipment is used in a manner not specified by the manufacturer, the protection provided by the equipment may be impaired.

In no event will Rockwell Automation, Inc. be responsible or liable for indirect or consequential damages resulting from the use or application of this equipment.

The examples and diagrams in this manual are included solely for illustrative purposes. Because of the many variables and requirements associated with any particular installation, Rockwell Automation, Inc. cannot assume responsibility or liability for actual use based on the examples and diagrams.

No patent liability is assumed by Rockwell Automation, Inc. with respect to use of information, circuits, equipment, or software described in this manual.

Reproduction of the contents of this manual, in whole or in part, without written permission of Rockwell Automation, Inc., is prohibited.

## Documentation Feedback

Your comments will help us serve your documentation needs better. If you have any suggestions on how to improve this document, complete this form, publication [RA-DU002](#), available at <http://www.rockwellautomation.com/literature/>.

Rockwell Automation maintains current product environmental information on its website at <http://www.rockwellautomation.com/rockwellautomation/about-us/sustainability-ethics/product-environmental-compliance.page>.

Allen-Bradley, ArmorBlock, ArmorBlock MaXum, ArmorPOINT, CompactBlock, Compact I/O, CompactLogix, ControlLogix, DriveLogix, FLEX, FLEX Ex, FlexLogix, Guard I/O, GuardLogix, InView, LISTEN, THINK, SOLVE, MicroLogix, PanelView, PLC-2, PLC-3, PLC-5, POINT I/O, PowerFlex, Rockwell Automation, Rockwell Software, RSLinx, SCANport, SLC, and SoftLogix are trademarks of Rockwell Automation, Inc.

Trademarks not belonging to Rockwell Automation are property of their respective companies.

ControlNet, DeviceNet, and EtherNet/IP are trademarks of the ODVA.

Rockwell Otomasyon Ticaret A.Ş., Kar Plaza İş Merkezi E Blok Kat:6 34752 İçerenköy, İstanbul, Tel: +90 (216) 5698400

**[www.rockwellautomation.com](http://www.rockwellautomation.com)**

---

### Power, Control and Information Solutions Headquarters

Americas: Rockwell Automation, 1201 South Second Street, Milwaukee, WI 53204-2496 USA, Tel: (1) 414.382.2000, Fax: (1) 414.382.4444

Europe/Middle East/Africa: Rockwell Automation NV, Pegasus Park, De Kleetlaan 12a, 1831 Diegem, Belgium, Tel: (32) 2 663 0600, Fax: (32) 2 663 0640

Asia Pacific: Rockwell Automation, Level 14, Core F, Cyberport 3, 100 Cyberport Road, Hong Kong, Tel: (852) 2887 4788, Fax: (852) 2508 1846

Publication 1769-TD005J-EN-P - September 2015

Supersedes Publication 1769-TD005I-EN-P - August 2014

Copyright © 2015 Rockwell Automation, Inc. All rights reserved. Printed in the U.S.A.