

About the FLEX I/O and FLEX Ex I/O Systems

1794 FLEX I/O Overview

FLEX I/O offers:

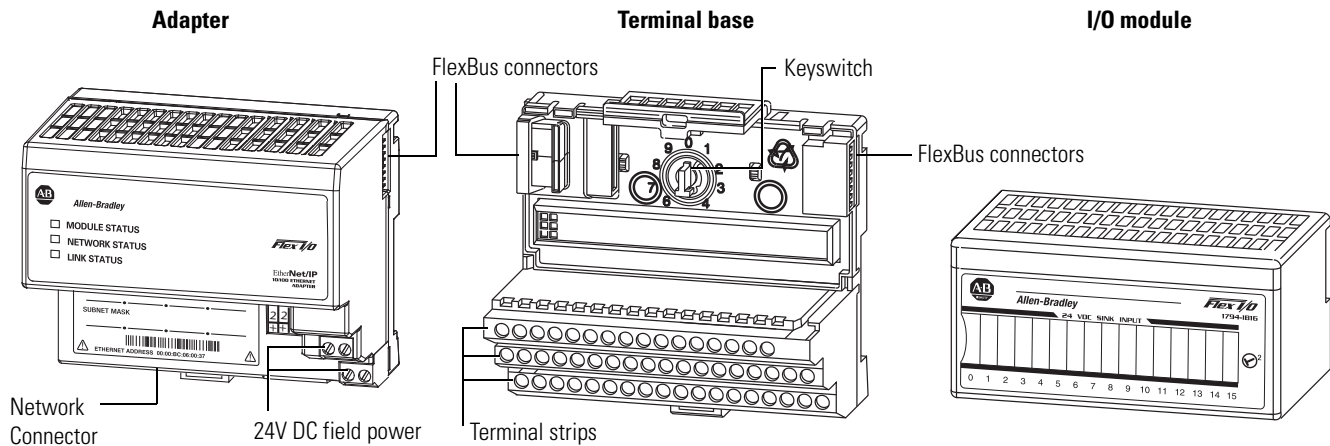

FLEX I/O is a Distributed I/O System that connects to several Networks including EtherNet/IP, ControlNet and DeviceNet.

Flexible, low-cost, modular I/O for distributed applications. FLEX I/O offers all the functions of larger, rack-based I/O without the space requirements.

Independently select the I/O, termination style, and network to meet your application needs.

Two separate connection terminals for field power let you daisy-chain power connections to adjacent terminal bases.

One adapter communicates with up to eight I/O modules. Allows connection to:

- 256 digital input/output points, or
- 96 analog input/output points, or
- mix of I/O to meet your needs.

Modularity of FLEX I/O system provides choice of network and ease of expansion. The wiring terminations are done almost entirely on the terminal base. Terminal base termination selection includes screw-clamp, spring-clamp, and cage-clamp to wire directly to 2-, 3-, or 4-wire devices. Additional options of D-shell, knife disconnect, and fused terminal bases are available.

Adjustable keyswitch prevents incorrect module insertion into a preconfigured terminal base.

Terminal bases can be exchanged without moving other bases in your system.

If desired, connect individual power supplies to each base to isolate modules. Plug the I/O module into the terminal base to connect the I/O bus and field devices.

Remove and insert modules under power. No direct wiring to the module enables you to change modules without disturbing field wiring or system power.

Mix and match I/O modules. There is a wide variety of digital, analog, and specialty modules.

Each FLEX I/O system contains at least one adapter, one terminal base, and one I/O module.

You can power the system with a FLEX power supply (1794-PS13 or -PS3), a 1606 switched mode power supply, or any other compatible power source. Use the terminal block on the terminal base to wire your field devices directly. Wiring directly saves you:

- installation and testing time
- multiple, long wiring runs and external terminal blocks
- control cabinet panel space

FLEX I/O provides additional savings if system problems develop. Combining your field-wiring terminations and the I/O interface into the same location saves you time and money by making your system easier to maintain and troubleshoot. Additionally, the full-featured FLEX I/O system lets you, in non-hazardous location, remove and insert modules under backplane power without disrupting your system.

Your FLEX I/O system can communicate on EtherNet/IP, ControlNet, DeviceNet, and many other open networks including, but not limited, to Remote I/O and PROFIBUS DP.

Adapters and other components are available for adding to your system as your specific application requirements change.

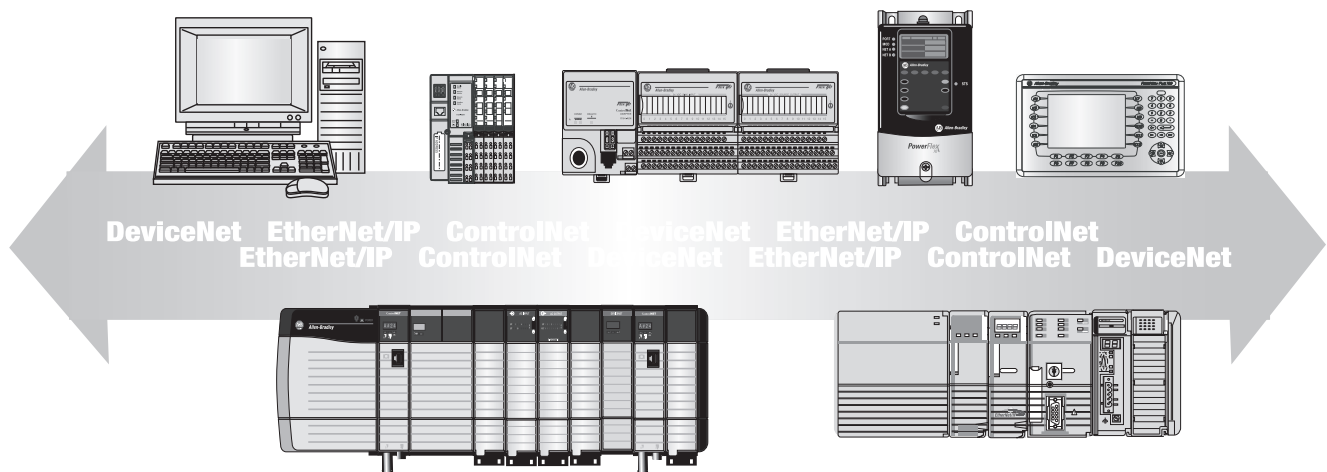

1794 FLEX I/O XT Overview

FLEX I/O XT modules are designated for extreme environment use.

They differ from their non XT counterparts only in operational temperature ranges and conformal coating is standard for FLEX I/O XT products.

FLEX I/O XT modules meet or exceed the following standards:

- ANSI / ISA-S71.04-1985; Class G1, G2 and G3 Environments
- CEI IEC 6065A-4; Class 1 and 2 Environments
- UL 746E
- MIL-1-46058C to ASTM-G21; (Tropicalization and fungicide)

These standards specify common emissions and classify their concentration levels in a number of industrial processes. Just a few of the common reactive agents that the FLEX I/O XT modules protect against are:

- H₂S – Hydrogen sulfide
- SO₂, SO₃ – Sulfur dioxide
- C_nH_n – Hydrocarbons
- NO_x – Oxides of nitrogen
- Cl₂ – Wet Chlorine / Dry Chlorine
- NH₃ – Ammonia

General FLEX I/O and FLEX I/O XT Specifications

The following table shows the similarities and differences between the FLEX I/O and the FLEX I/O XT specifications.

Specifications Comparison

Attribute ⁽¹⁾	1794 FLEX I/O	1794 FLEX I/O XT
Temperature, operating	0...55 °C (32...131 °F)	-20...70 °C (-4...185 °F)
Temperature, nonoperating	-40...85 °C (-40...185 °F)	-40...85 °C (-40...185 °F)
Relative humidity	5...95% non-condensing	
Shock, operating ⁽²⁾	30 g peak acceleration, 11(±1) ms pulse width	
Shock, nonoperating ⁽¹⁾	50 g peak acceleration, 11(±1) ms pulse width	
Vibration	Tested 5 g @ 10...500 Hz per IEC 68-2-6	
Wire size	0.34mm ² ...2.5 mm ² (22...12 AWG) stranded copper wire rated at 75 °C or higher 1.2 mm (3/64 in.) insulation max	
Atmospheric protection	non conformal coated	conformal coated to meet or exceed the following standards: <ul style="list-style-type: none"> • ANSI / ISA-S71.04-1985; Class G1, G2 and G3 Environments • CEI IEC 6065A-4; Class 1 and 2 Environments • UL 746E • MIL-1-46058C to ASTM-G21; (Tropicalization and fungicide)

Specifications Comparison

Attribute ⁽¹⁾	1794 FLEX I/O	1794 FLEX I/O XT
Certifications (when product is marked) ⁽³⁾	<ul style="list-style-type: none"> • UL Listed Industrial Control Equipment • UL Listed for Class I, Division 2 Groups A, B, C, D Hazardous Locations • CE Marked for all applicable directives • CE / ATEX • CSA Certified Process Control Equipment for Class I, Division 2 Group A, B, C, D Hazardous Locations • C-Tick Marked for all applicable acts • KCC • Marine Certification • SIL 2 Certification • ODVA • ControlNet 	

(1) For all other product-specific specifications, including environmental and certification, see the product sections within this Selection Guide.

(2) To maintain these specifications, you must use DIN rail locks.

(3) See the Product Certification link at www.ab.com for Declarations of Conformity, Certificates, and other certification details.

Specify a FLEX I/O or FLEX I/O XT System

Follow these steps as you specify your FLEX I/O or FLEX I/O XT system:

✓	Step	See	Page
	1 Select a communication adapter Choose the network for your operating system.	CIP Network Infrastructure	7
		Select a Network	8
	2 Select I/O modules based on field device <ul style="list-style-type: none"> • location of the device • your application • number of points needed • number of points available per module • number of modules Or use the Integrated Architecture Builder tool at http://www.rockwellautomation.com/en/e-tools/configuration.html	Digital I/O Modules	15
		FLEX I/O Analog, Thermocouple and RTD Modules	35
		FLEX I/O Counter Modules	58
	3 Select a terminal base Choose an appropriate terminal base for your modules.	General Specification Comparison	65
	4 Choose appropriate power supplies <ul style="list-style-type: none"> • Choose appropriate power supply • Ensure sufficient power for the communication adapter and modules 	Power Supply Definitions	67
		Power Requirements and Transformer Sizing	68
	5 Determine mounting requirements and select accessories <ul style="list-style-type: none"> • Determine whether to panel mount or DIN rail mount the FLEX I/O system and at what orientation (horizontal or vertical) • Choose appropriate optional accessories to enhance your system 	panel mount or DIN rail mount	113
		1794-CE1 and 1794-CE3 Extender Cables	115
		1794-NM1 FLEX I/O Mounting Kit	115
		1492-EA35 DIN Rail Locks	116
		1794-LBL FLEX I/O Label Kit	116

Select FLEX I/O Communication Adapters

Step 1 – Select:

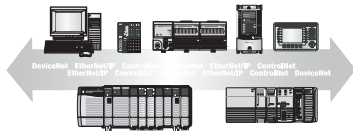

a communication adapter based on the appropriate network

A FLEX I/O adapter module interfaces FLEX I/O modules to an I/O scanner port across a communication network. The FLEX I/O adapter module contains a built-in power supply that converts 24V DC to 5V DC for the backplane to power the FLEX I/O modules.

- Your 1794 FLEX I/O system can communicate on:
 - EtherNet/IP
 - ControlNet, single media or redundant
 - DeviceNet
 - Many other open networks including, Remote I/O, PROFIBUS DP, and others from Encompass partners

CIP Network Infrastructure

The Common Industrial Protocol (CIP) allows complete integration of control with information, multiple CIP networks and standard Internet technologies. CIP provides manufacturers with a scalable and coherent architecture incorporating discrete, process, safety, synchronization and motion applications using the same network technology as the ERP, MES enterprise levels applications. Ultimately, network convergence helps align technology with business goals for business process transformation and enterprise-wide visibility.

The following networks share the Common Industrial Protocol at their upper levels, while remaining media independent at their lower levels. This allows manufacturers to specify the best network for their application and eliminate costly and complex gateways when connecting dissimilar upper level networks.

- EtherNet/IP is an open industrial networking standard that supports implicit and explicit messaging and uses commercial, off-the-shelf Ethernet equipment and physical media.
- ControlNet allows intelligent, high-speed control devices to share the information required for supervisory control, work-cell coordination, operator interface, remote device configuration, programming, and troubleshooting.
- DeviceNet offers high-speed access to plant-floor data from a broad range of plant floor devices and a significant reduction in wiring.

Select a Network

You can configure your system for information exchange between a range of field devices and a specific scanner. You select the communication adapters for the networks that meet your needs:

Network Comparison by Application Requirement

Application Requirements	Network ⁽¹⁾	Communication Adapter
<ul style="list-style-type: none"> Plant management (material handling) Configuration, data collection, and control on a single, high-speed network Time-critical applications with no established schedule Data sent regularly Internet/Intranet connection Built-in switch, or high availability requirement (2-port AENTR) 	EtherNet/IP	1794-AENT 1794-AENTR 1794-AENTRXT
<ul style="list-style-type: none"> High-speed transfer of time-critical data between controllers and I/O devices Deterministic and repeatable data delivery Media redundancy 	ControlNet	1794-ACN15 1794-ACN15K ⁽²⁾ 1794-ACNR15 ⁽³⁾ 1794-ACNR15XT ⁽⁴⁾
<ul style="list-style-type: none"> Connections of low-level devices to plant floor controllers More diagnostics for improved data collection and fault detection Less wiring and reduced start-up time than a traditional, hard-wired system 	DeviceNet	1794-ADN 1794-ADNK
<ul style="list-style-type: none"> Connections to Remote I/O networks 	Remote I/O	1794-ASB 1794-ASB2
<ul style="list-style-type: none"> Connection to PROFIBUS DP and DPV1 networks 	PROFIBUS DP PROFIBUS DPV1	1794-APB 1794-APBDPV1

(1) Communication adapters and other components are available for adding to your system as your specific application requirements change. For more information, go to www.rockwellautomation.com/encompass and search for products under the FLEX I/O platform.

(2) Modules that have the letter K in the last position of the catalog number, before the series designation, refer to conformal coated versions of the standard modules. These modules meet the following certifications: ANSI / ISA-S71.04-1985, Class G1, G2, and G3 environments; CEI IEC 6065A-4 Class 1 and 2 environments; UL 746E

(3) Modules that have the letter R in the catalog number, before the series designation, refer to redundancy versions of the standard modules and are meant for redundancy networks.

(4) Modules that have the letters XT in the catalog number, before the series designation, refer to extended temperatures version of the standard modules.

EtherNet/IP Network

EtherNet/IP is a network suitable for use in industrial environment and time-critical applications. EtherNet/IP uses standard Ethernet and TCP/IP technologies and an open application layer protocol called the Control and Information Protocol (CIP). CIP is also the application layer used in DeviceNet and ControlNet networks. The open Application Layer protocol makes interoperability and interchangeability of industrial automation and control devices on EtherNet/IP a reality for automation and control applications.

The 1794-AENT and 1794-AENTR connect FLEX I/O to Ethernet/IP enabled controllers such as ControlLogix or CompactLogix.

Select FLEX I/O Modules

Step 2 – Select:

I/O modules

The FLEX I/O module plugs into the terminal base, connecting to the I/O bus and field devices. Since there is no direct wiring to the I/O module, you can remove and insert modules under backplane power, enabling you to change modules without disturbing field wiring, other I/O modules, or FLEX backplane power. This eliminates costly downtime and the inefficiencies of restarting a system.

The choices and flexibility you have with I/O types range from digital and analog to temperature and motion control. FLEX I/O allows you to use as many as eight terminal bases per adapter which can provide a maximum of 256 digital I/O points or 96 analog channels per adapter. You can mix and match digital and analog I/O with mounting and wiring options, supplying you with a successful distributed system solution.

This flexibility gives you the following choices of I/O signal types:

- Digital: AC and DC voltage signals
- Analog: current or voltage
- Relay: normally open, 2 A capability
- Protected outputs: non-latching, latching, and with diagnostics
- Temperature: thermocouple or RTD
- Motion: high-speed counters, flow metering, and totalization
- Combo modules: combination of input and output capability
- Harsh environments: use FLEX I/O XT in harsh environments
- Intrinsic Safety (IS): use FLEX Ex I/O in hazardous areas to connect to field devices

Digital I/O Modules

Digital I/O modules interface with field devices such as:

- pushbutton and limit switches
- on/off actuators such as motor starters, pilot lights, and annunciators
- relay contacts

Features

Modules are available in different densities ranging from 8 to 32 points.

- Digital I/O modules cover a wide electrical range:

120V AC: Input/Output and Isolated Input/Output, 8 and 16 point

220V AC: Input/Output, 8 point

24V DC: Input/Output/Combination, Sink/Source, Protected, Electronically Fused, Diagnostic, 8, 16, and 32 point

48V DC: Sink Input/Source Output, 16 point

Relay: Sink/Source, 8 point

- Isolated inputs and outputs can be used in applications such as motor control centers where individual control transformers are used.
- Protected outputs (P) have electronic protection which acts to shut the output down in reaction to a short circuit, overload, or over-temperature condition.
Recovery from shutdown is automatic upon removal of the output fault. No fault status is provided to the processor.
- Electronic Fused (EP) module acts to open the output when a fault occurs. The fuse can be reset by operating a pushbutton, via software, or by cycling the input power. Fault status is provided to the processor.
- Diagnostic (D) modules detect, indicate, and report to the processor the following faults:
 - open input or output field devices or wiring
 - shorted output field devices
 - shorted input or output wiring
 - reverse polarity of user supply wiring
- Selectable input filter times from < 1 to 60 ms.
- LED for each channel indicating status of:
 - corresponding input device
 - output signal

Digital I/O Module Summary

Catalog Number	Inputs	Outputs	Terminal Base Unit	Electrical Range	Module Type
AC Modules					
1794-IA8	8	—	1794-TBN, 1794-TB2, 1794-TB3, 1794-TB3S, 1794-TBKD, 1794-TB3K, 1794-TB3SK, 1794-TBNK	120V AC	Nonisolated inputs
1794-IA8I					Isolated inputs
1794-IA16	16		1794-TB3, 1794-TB3S, 1794-TBN ⁽¹⁾ , 1794-TB3K, 1794-TB3SK, 1794-TBNK		Nonisolated inputs
1794-IM8	8	—	1794-TBN, 1794-TBNK	240V AC	
1794-IM16	16				
1794-OA8	—	8	1794-TBNF, 1794-TB2, 1794-TB3, 1794-TB3S, 1794-TBN, 1794-TBKD, 1794-TBNFK, 1794-TB3K, 1794-TB3SK, 1794-TBNK	120V AC	Nonisolated inputs
1794-OA8I					Isolated outputs
1794-OA16		16	1794-TB3, 1794-TB2, 1794-TB3S, 1794-TB3K, 1794-TB3SK, 1794-TBN ⁽¹⁾ , 1794-TBKD, 1794-TBNK	120V AC	Nonisolated outputs
1794-OM8		8	1794-TBNF, 1794-TBN, 1794-TBNFK, 1794-TBNK	240V AC	
1794-OM16		16			

Digital I/O Module Summary

Catalog Number	Inputs	Outputs	Terminal Base Unit	Electrical Range	Module Type
DC Modules					
1794-IB8	8	—	1794-TB3, 1794-TB3S, 1794-TB3K, 1794-TB3SK	24V DC	Nonisolated inputs
1794-IB16	16	—	1794-TB32, 1794-TB32S	24V DC	Group isolated inputs Diagnostics
1794-IB16D					Nonisolated inputs Extended temperatures
1794-IB16XT					Nonisolated I/O
1794-IB10XOB6	10	6	1794-TB2, 1794-TB3, 1794-TB3S, 1794-TB3K, 1794-TB3SK	24V DC	Nonisolated I/O Extended temperatures
1794-IB10XOB6XT					Nonisolated I/O Protected outputs
1794-IB16XOB16P	16	—	1794-TB3, 1794-TB3S, 1794-TB3K, 1794-TB3SK	48V DC 5V DC 125V DC 24V DC	Nonisolated inputs
1794-IC16					Nonisolated inputs with groups
1794-IG16					
1794-IH16					
1794-IV16					
1794-IB32					
1794-IV32	Nonisolated, protected outputs				
1794-OB8	—	8	1794-TB2, 1794-TB3, 1794-TB3S, 1794-TB3K, 1794-TB3SK	24V DC	Nonisolated, protected outputs
1794-OB8EP					Nonisolated, protected outputs Extended temperatures
1794-OB8EPXT					Nonisolated outputs
1794-OB16	—	16	1794-TB2, 1794-TB3, 1794-TB3S, 1794-TB3K, 1794-TB3SK	24V DC	Nonisolated, protected outputs Conformal coated
1794-OB16D					Nonisolated, protected outputs Extended temperatures
1794-OB16P					Nonisolated, protected outputs with groups
1794-OB16PXT					Nonisolated, protected outputs with groups
1794-OB32P		32	1794-TB32, 1794-TB32S		Nonisolated, protected outputs with groups

Digital I/O Module Summary

Catalog Number	Inputs	Outputs	Terminal Base Unit	Electrical Range	Module Type
1794-OC16	—	16	1794-TB3, 1794-TB3S, 1794-TB3K, 1794-TB3SK	48V DC	Nonisolated outputs
1794-OG16				5V DC	
1794-OV16				24V DC	
1794-OV16P					
1794-OV32		32	1794-TB32, 1794-TB32S		Nonisolated, protected outputs
					Nonisolated inputs in groups

Relay Modules

1794-OW8	—	8	1794-TB2, 1794-TB3, 1794-TB3S, 1794-TBN, 1794-TBNF, 1794-TB3K, 1794-TB3SK, 1794-TBNK, 1794-TBNFK	24V DC	Isolated outputs Electromagnetic relays
1794-OW8XT					Isolated outputs Electromagnetic relays Extended temperatures

(1) Auxiliary terminal strips are required when using the 1794-TBN.

Select Input Filter Times for Digital Modules

Input filter times can be set to the following values (EtherNet/IP, ControlNet, and DeviceNet only).

Input Filter Times – AC Modules

Filter Times for Inputs	Maximum Times (ms)			
	OFF to ON		ON to OFF	
	1794-IA8, 1794-IA8I	1794-IA16, 1794-IM8	1794-IA8, 1794-IA8I	1794-IA16, 1794-IM8
Filter time 0 (default)	8.4 ⁽¹⁾	7.5	26.4 ⁽²⁾	26.5
1	8.6	8	26.6	27
2	9	9	27	28
3	10	10	28	29
4	12	12	30	31
5	16	16	34	35
6	24	24.5	42	44
7	40	42	58	60.5

(1) OFF to ON filter is 8 ms.

(2) ON to OFF filter is 26 ms.

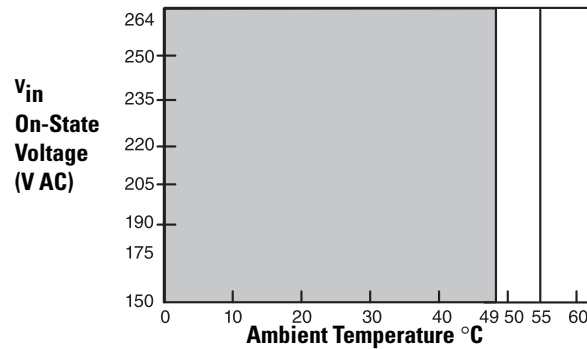
1794-OM8 Derating Curve

The area within the curve represents the safe operating range for the module under various conditions of user supplied 220V AC supply voltages and ambient temperatures.

= Normal mounting safe operating range included
 = Other mounting positions (including inverted horizontal, vertical) safe operating range

FLEX I/O Digital DC Input Modules
Digital DC Input Comparison

Specification	1794-IB8, 1794-IB16, 1794-IB16XT	1794-IV16	1794-IB32	1794-IV32	1794-IC16	1794-IG16	1794-IH16
Voltage, on-state input, min	10V DC, sinking	10V DC, sourcing	19.2V DC, sinking	19.2V DC, sourcing	30V DC, sinking	-0.2V DC, TTL	90V DC, sinking
Voltage, on-state input, nom	24V DC				48V DC	0V DC	125V DC
Voltage, on-state input, max	31.2V DC				60V DC	0.8V DC	146V DC
Voltage, off-state input, max	5V DC				10V DC	2.0...5.5V DC	20V DC
Terminal base unit	1794-TB3, 1794-TB3S, 1794-TB3K, 1794-TB3SK	1794-TB3, 1794-TB3S, 1794-TB3K, 1794-TB3SK	1794-TB32, 1794-TB32S		1794-TB3, 1794-TB3S, 1794-TB3K, 1794-TB3SK		
Current, on-state input, min	2.0 mA					—	1.0 mA
Current, on-state input, nom	8 mA @ 24V DC		4.1 mA @ 24V DC	4.1 mA	5 mA @ 48V DC	—	2 mA @ 125V DC
Current, on-state input, max	1794-IB16: 12 mA 1794-IB8, 1794-IV16: 11 mA 1794-IB16XT: 5.0 mA		6 mA	6 mA	11 mA	—	3 mA
Current, off-state input, max	1.5 mA					4.1 mA	0.8 mA
Input impedance, max	4.6 kΩ	4.7 kΩ	6 kΩ		11 kΩ	—	60 kΩ
Power dissipation, max	3.5 W @ 31.2V DC ⁽¹⁾	5.7 W @ 31.2V DC	6.0 W @ 31.2V DC		6.4 W @ 60V DC	1.4 W @ 5.5V DC	6 W @ 146V DC
Thermal dissipation, max	11.9 BTU/hr @ 31.2V DC ⁽²⁾	19.4 BTU/hr @ 31.2V DC	20.5 BTU/hr @ 31.2V DC		21.9 BTU/hr @ 60V DC	4.78 BTU/hr @ 5.5V DC	20.47 BTU/hr @ 146V DC

Digital DC Input Comparison

Specification	1794-IB8, 1794-IB16, 1794-IB16XT	1794-IV16	1794-IB32	1794-IV32	1794-IC16	1794-IG16	1794-IH16
Dimensions (HxWxD), approx	46 x 94 x 53 mm (1.8 x 3.7 x 2.1 in.) 94 x 94 x 69 mm (3.7 x 3.7 x 2.7 in.) installed						
Isolation voltage	50V (continuous), Basic Insulation Type, between field side and system No isolation between individual channels 1794-IB8, 1794-IB16XT: Type tested at 850V DC for 60 s 1794-IV16: Type tested at 700V DC for 60 s 1794-IB32: Routine tested at 2121V DC for 2 s 1794-IV32: Type tested at 707V DC for 60 s All other modules: Type tested at 707V DC for 60 s			Tested at 1900V DC for 1 s, I/O to system No isolation between individual channels		50V (continuous), Basic Insulation Type, between field side and system No isolation between individual channels Type tested at 707V DC for 60 s	250V (continuous), Basic Insulation Type, between field side and system Type tested at 1706V DC for 60 s, between field side and system No isolation between individual channels

- (1) Power dissipation – **1794-IB16:** 6.1 W @ 31.2V DC; **1794-IB16XT:** 2 W @ 31.2V DC
- (2) Thermal dissipation – **1794-IB16:** 20.8 BTU/hr at 31.2V DC; **1794-IB16XT:** 9.2 BTU/hr @ 31.2V DC

- IMPORTANT**
- Do not put the 1794-IB8 module next to an output module in 8-point compact addressing with the 1794-ASB2/C or 1794-ASB/D.
 - Modules have a yellow status indicator for each channel. These indicators are driven from the customer field-side input device.

1794-IB16 Derating Curve

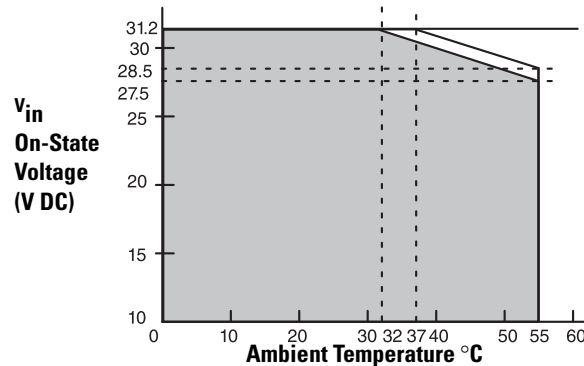

The area within the curve represents the safe operating range for the module under various conditions of user supplied 24V DC supply voltages and ambient temperatures.

- = Normal mounting safe operating range
- = Other mounting positions (including inverted horizontal, vertical) safe operating range

Select a FLEX I/O Terminal Base Unit

Step 3 – Select:

the appropriate terminal base unit for your module and system

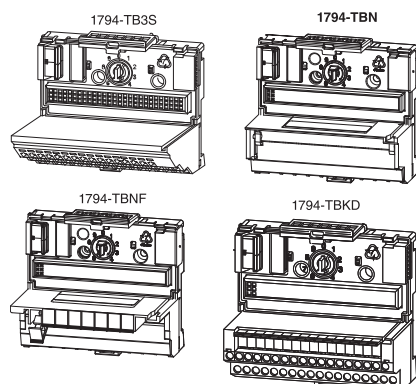

Each FLEX I/O module requires a terminal base unit that snaps onto the DIN rail to the right of the I/O adapter. The terminal bases provide terminal connection points for the I/O wiring and plug together to form the backplane. They are available with screw, clamp, or spring terminations.

Common Terminal Base Characteristics

Current Capacity, max	Wire Size	Dimensions (HxWxD)
10	0.34...2.1 mm ² (22...14 AWG) solid or stranded copper wire rated at 75 °C (167 °F) or greater, 1.2 mm (3/64 in.) insulation max	94 x 94 x 69 mm 3.7 x 3.7 x 2.7 in. 1794-TB37DS and 1794-TB62DS* (1) 127 x 94 x 69 mm 5.0 x 3.7 x 2.7 in

(1) Measured with expansion module installed.

The following table is a comparison of general specifications for each FLEX I/O terminal base unit. For compatibility with FLEX I/O modules, see Table Digital I/O Module Summary on page 16.

General Specification Comparison

Catalog ⁽¹⁾	Termination Type	Connections	Used in Applications	Current Capacity, max	Wiring Category	Purpose
1794-TB2	Cage clamp	16 I/O; 18 common; 2 +V	Up to 132V AC/156V DC	10	2	A generic 2-wire version of the 1794-TB3.
1794-TB3, 1794-TB3K ⁽²⁾		16 I/O; 18 common; 18 +V				Module dependent
1794-TB3S, 1794-TB3SK	Spring clamp					A spring clamp version of the 1794-TB3 – provides faster, simpler wire installation.
1794-TB32	Cage clamp	32 I/O; 8 common; 8 +V	Up to 31.2V DC			A 32-point version of the 1794-TB3 to be used with 32-point digital modules and the 1794-IB16D module.
1794-TB32S	Spring clamp					A spring clamp version of the 1794-TB32.
1794-TB3G, 1794-TB3GK ⁽²⁾	Grounded screw clamp	36 I/O; 2 common; 2 +V; 10 chassis ground				A screw clamp terminal base unit with individual grounding used with certain analog modules.
1794-TB3GS, 1794-TB3GSK ⁽²⁾	Grounded spring clamp				2	A spring clamp version of the 1794-TB3G.

General Specification Comparison

Catalog ⁽¹⁾	Termination Type	Connections	Used in Applications	Current Capacity, max	Wiring Category	Purpose
1794-TB3T	Cage clamp, temperature	16 I/O; 10 common; 4 +V; 8 chassis ground; 2 sets of CJC for temperature modules	Up to 132V AC/156V DC	10	Module dependent	A cage clamp terminal base to be used with the 1794-IT8 or 1794-IRT8 module (when used in thermocouple mode) – also provides chassis ground connections for the 1794-IR8 and analog modules.
1794-TB3TS, 1794-TB3TSK ⁽²⁾	Spring clamp, temperature	16 I/O; 10 common; 4 +V; 8 chassis ground; 2 sets of CJC for temperature modules	Up to 132V AC/156V DC	10	2	A spring clamp version of the 1794-TB3T.
1794-TBKD	Cage clamp, knife disconnect	16 I/O; 18 common; 2 +V	—		Module dependent	A cage clamp terminal base with 16 knife disconnects.
1794-TBKDS						A spring clamp version of the 1794-TBKD.
1794-TBN, 1794-TBNK ⁽²⁾	Screw clamp, NEMA-style	16 I/O; 2 common; 2 +V	264V AC/DC			A NEMA-style screw clamp terminal base for larger gauge wires with a cover for I/O wiring.
1794-TBNF	Screw clamp, fused NEMA-style					Provides eight 5 x 20 mm fused, screw terminals with a cover for I/O wiring – shipped with fuses for the 1794-OA8 module; can be used to fuse the 1794-OM8 and 1794-OW8 modules with a replacement fuse. ⁽³⁾
1794-TB37DS	D-shell	37 Pin; digital and analog	—		Module dependent	A 37-pin D-shell termination for both digital and analog modules.
1794-TB62DS		62 Point;				A 62-pin D-shell termination for both digital and analog modules.
1794-TB62DSG	Grounded D-shell	62 Point; chassis ground				A grounded version of the 1794-TB62DS – for use with analog modules.
1794-TB62DST	D-shell	16 I/O; 18 common; 2 +V; 2 sets of CJC for temperature modules				A 62-pin D-shell termination to be used with the 1794-IT8 or 1794-IRT8 module (when used in thermocouple mode) – also provides chassis ground connections for analog modules.

- (1) Isolation voltage, channel to channel, is determined by the insert module. Use this conductor category information for planning conductor routing. Refer to Industrial Automation Wiring and Grounding Guidelines, publication [1770-4.1](#).
- (2) The letter K in the last position of the catalog number, before the series designation, indicates a conformal coated versions of standard modules and can be used with extended temperature modules (modules ending in -XT).
- (3) Contains eight 5 x 20 mm fuses (one for each even-numbered terminal – 0...14 on row B). Shipped with 1.6 A, 250V AC Slow Blow fuse suitable for the 1794-OA8 AC output module. Refer to individual installation instructions for fusing recommendations for other modules. Littlefuse PN23901.6 A-B PN94171304, SAN-O PNSD6-1.6A.

Select a FLEX I/O Power Supply

Step 4 – Select:

if power consumption exceeds the maximum for a single power supply, install additional power supplies

FLEX I/O modules are interfaced to the I/O link through a FLEX I/O adapter module with a built-in 24V DC input power supply. The FLEX I/O modules receive power from the adapter/power supply through the backplane. The 120V AC to 24V DC power supply (1794-PS13 or 1794-PS3) is also available for powering the adapter/power supply.

General Specification Comparison

Catalog	Power Supply Input Voltage, nom	Power Supply Input Power	Apparent Input Power, max	Transformer Load, max	Output Current, max	Output Voltage, nom	Dimensions (HxWxD), approx
1794-PS3	120V/220V AC	86 W	205 VA	250 VA	3.0 A	24V DC	87 x 94 x 69 mm (3.4 x 3.7 x 2.7 in.)
1794-PS13		36 W	53 VA	90 VA	1.3 A		87 x 69 x 69 mm (3.4 x 2.7 x 2.7 in.)

Power Supply Definitions

Module Supply Voltage — This is typically either 120V AC or 24V DC nominal voltage that is supplied from an external power source wired to the module terminal base unit.

All Flex I/O adapters provide internal power to the maximum possible number of 8 Flex I/O modules. Power supply modules are required to provide 24V to the adapters.

The 1794-PS13 power supply is capable of supplying a maximum of 1.3 A at 24V DC. The output surge current is sufficient to drive four adapters with a surge of 23 A for 2 ms each operating at 24V DC.

The 1794-PS3 power supply is capable of supplying a maximum of 3 A⁽¹⁾ at 24V DC. The output surge current is sufficient to drive six adapters with a surge of 23 A for 2 ms each operating at 24V DC.

Non-Allen-Bradley DC power supplies can also be used, but should operate within the specifications for the devices they are powering. Size the power supply by calculating the total current consumed by summing the currents for each of the modules used for the power supply operating voltage applied.

(1) This refers to horizontal mounting; 2.8 A maximum for all other mountings. Refer to the derating curve in the installation instructions for that module.

The 1606 switched mode power supplies are capable of supplying a maximum of up to 40 A at 24V DC and can be used as an alternative when more power is needed.

Digital Input Modules require supplied 24V DC (19.2...31.2V DC) and consume the currents listed in the module specifications.

Digital Output Modules require supplied 24V DC (19.2...31.2V DC) and consume the currents listed in the module specifications plus the total current consumed by their loads. The load current is limited by the maximum load current and surge listed.

Combination Digital Modules have a combination of inputs and outputs. The current load should be determined as described for the combined input and output specifications listed.

Analog Input Modules require supplied 24V DC (19.2...31.2V DC) and consume the currents listed in the module specifications. In addition, adequate power must be supplied to the 1794-IE8 and 1794-IF4I transmitters to deliver input terminal voltage or drive 20 mA into the input impedance listed. This power source may be the same as the module power and can be included in the power supply calculated.

Analog Output Modules require supplied 24V DC (19.2...31.2V DC) and consume the currents listed plus the total current consumed by their loads. The load current is limited by maximum current or resistive load permitted per channel.

Combination Analog Modules have a combination of analog inputs and outputs. The current load should be determined as described previously for the combined modules and output specifications listed. The output load current is limited by the maximum current or resistive load permitted per channel. In addition, adequate power must be supplied to the 1794-IE8 and 1794-IF4I transmitters to deliver input terminal voltage or drive 20 mA into the input impedance listed. This power source may be the same as the module power and can be included in the power supply calculation.

Counter Modules require module power, transmitter input power, and in some cases output load power. If output load power is required, use a separate power supply for output load power for noise immunity.

Power Requirements and Transformer Sizing

- Use the real power value in watts for determining the amount of heat dissipation you will have inside the enclosure.
- Use the apparent power value in VA for estimated power distribution sizing.
- Use the transformer load value in VA of each power supply plus all other loads on a transformer to determine the required transformer size.

1794-PS3 AC/DC

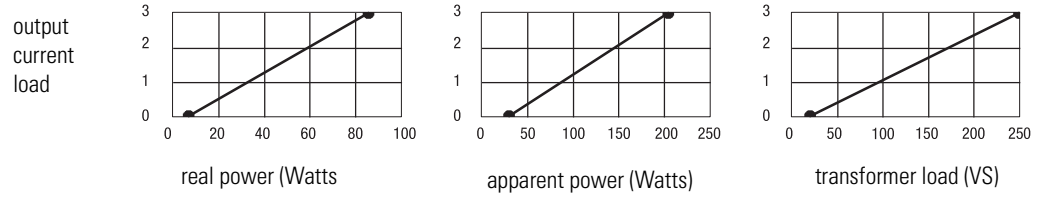

1794-PS13 AC/DC

