

Modular electrical terminal CPX



Terminal CPX

Key features

FESTO

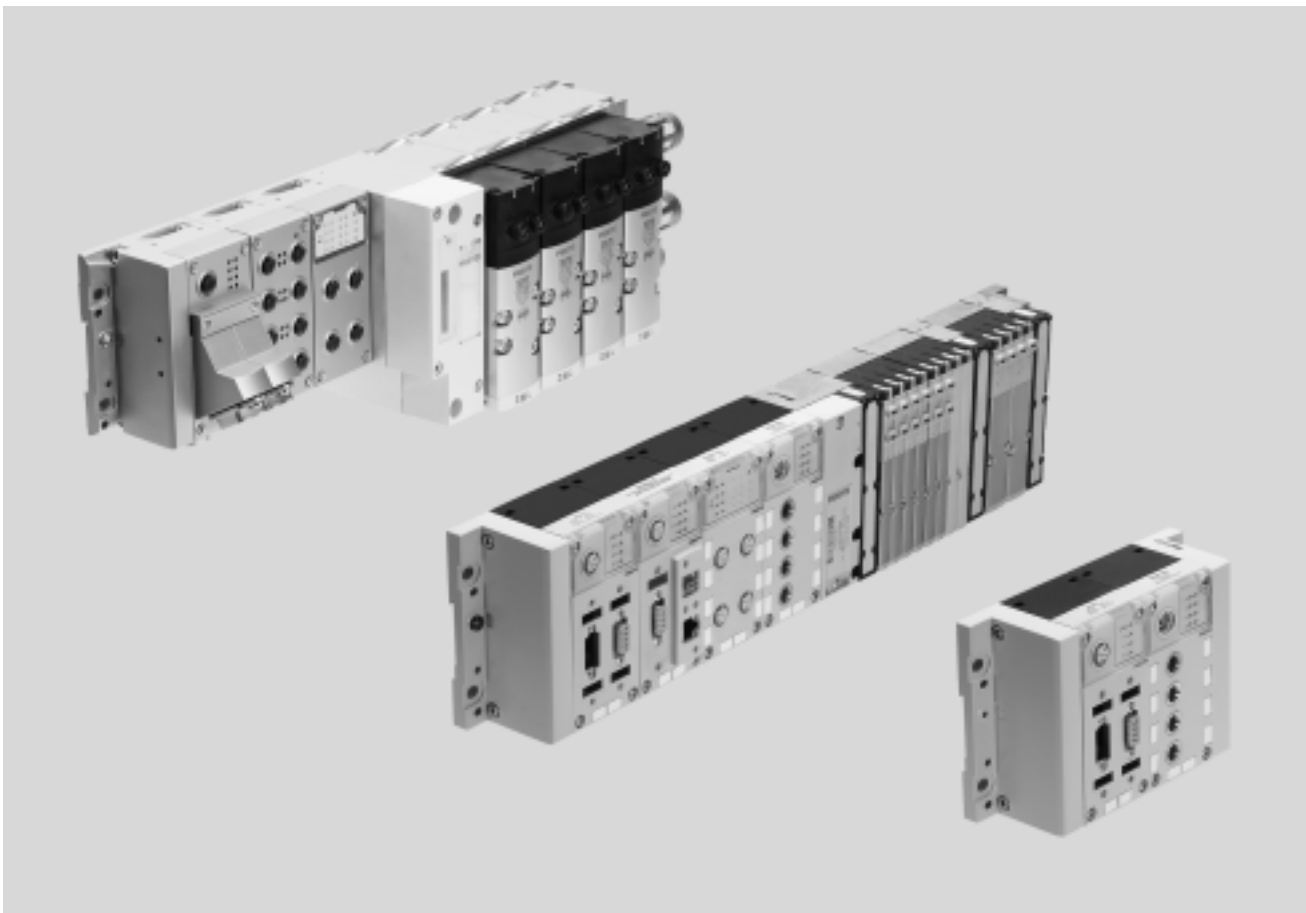

Key features

Installation concept	Electrical components	Assembly	Operation
<ul style="list-style-type: none"> Choice of several valve terminal types for different applications: <ul style="list-style-type: none"> – MPA-S – MPA-L Economical from the smallest configuration up to the maximum number of modules Up to 9 electrical input/output modules plus bus nodes and pneumatic interface/electronic modules for valves Extensive range of functions and connection options for the electrical modules Choice of connection technology for technically and economically optimised connections Can be used as a dedicated remote I/O module 	<ul style="list-style-type: none"> High operating voltage tolerance ($\pm 25\%$) Choice of M18, 7/8" or AIDA push-pull connection for power supply Open to all fieldbus protocols and Ethernet Optional function and technology modules for preprocessing IT services and TCP/IP such as remote maintenance, remote diagnostics, web server, text message and e-mail alert Digital inputs and outputs, 4-/8-/16-way, optionally available with individual channel diagnostics Analogue inputs and outputs, 2-/4-way, optionally with HART protocol Pressure inputs Temperature inputs Controllers for pneumatic and electrical axes IP65 and IP67 or IP20 	<ul style="list-style-type: none"> Wall or H-rail mounting, also on mobile systems Conversions/extensions are possible at any time, individual linking with CPX metal design Modular system offering a range of configuration options Fully assembled and tested unit Lower selection, ordering, assembly and commissioning costs thanks to the central CPX terminal Choice of pneumatic components for optimised control loop system design Decentralised, subordinate CPI installation system improves cycle times by up to 30% Safe and convenient earthing thanks to earthing plate 	<ul style="list-style-type: none"> Fast troubleshooting thanks to an extensive selection of LEDs (some of which are multi-coloured) on the bus node and on all I/O modules Supports module and channel-oriented diagnostics On-the-spot diagnostics in plain text via handheld device Fieldbus/Ethernet remote diagnostics Innovative diagnostic support with integrated web server/web monitor or maintenance tool with USB adapter for PC Optimised commissioning thanks to parameterisable functions Reliability of service with connection blocks and modules that are quick to replace without changing the wiring

Terminal CPX

Key features

Pneumatic variants of the CPX terminal

The electrical CPX terminal is a modular peripheral system for valve terminals.

The system is specifically designed so that the valve terminal can be adapted to suit different applications.

The modular system design lets you configure the number of valves, inputs and additional outputs to suit the application.

With valve terminal – decentralised

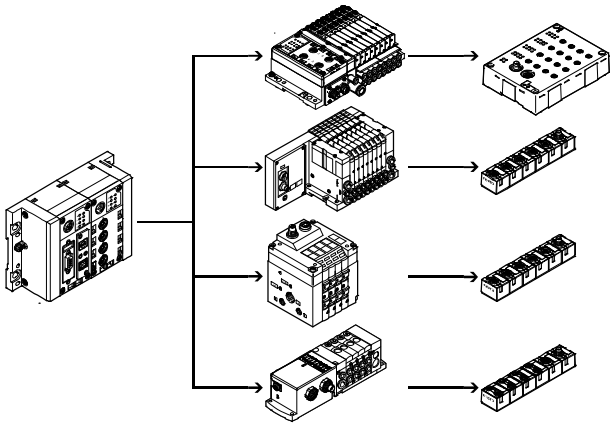

With valve terminal MPA-S – centralised

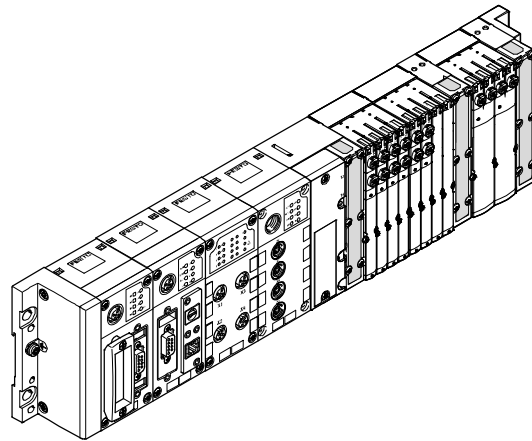

With valve terminal VTSA – centralised

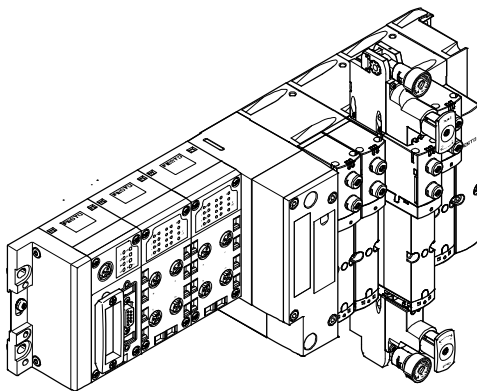

In metal design with valve terminal VTSA – centralised

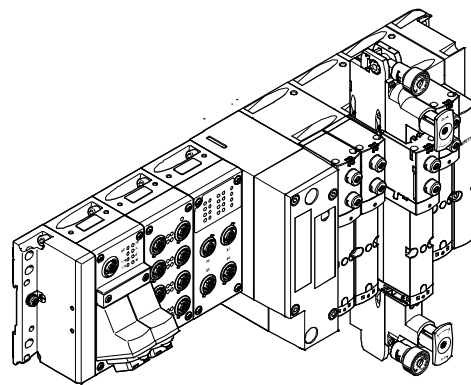

Terminal CPX

Key features

Variants of the CPX terminal controller (with bus node, without preprocessing)

Bus node

Different bus nodes are used to integrate the terminal in the control systems of various manufacturers. The CPX terminal can therefore be operated on over 90% of the most commonly used fieldbus systems:

- PROFIBUS DP
- PROFINET
- INTERBUS

- DeviceNet
- CANopen
- CC-Link

Integration in universal networks based on Ethernet opens up new possibilities. Faster data transmission, real-time capability and above all additional IT services such

as file transfer, web server, web monitor as integrated website in the CPX terminal, text message/e-mail alerts, etc. open up a wide range of synergies.

These include standardised and universal communication technology across all areas, including operating level, management level and field

level in the production environment, with protection to IP65, IP67.

The following protocols are supported:

- EtherNet/IP
- Modbus/TCP
- PROFINET
- POWERLINK
- EtherCAT
- Sercos III

Bus node

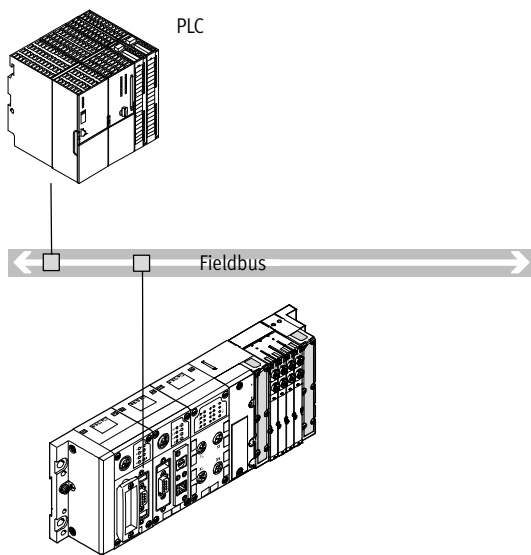

- Communication with higher-order controller via fieldbus
- No preprocessing
- Fieldbus protocol dependent on CPX bus node used
- Up to 90 I/Os, depending on the bus node used

Industrial Ethernet bus node

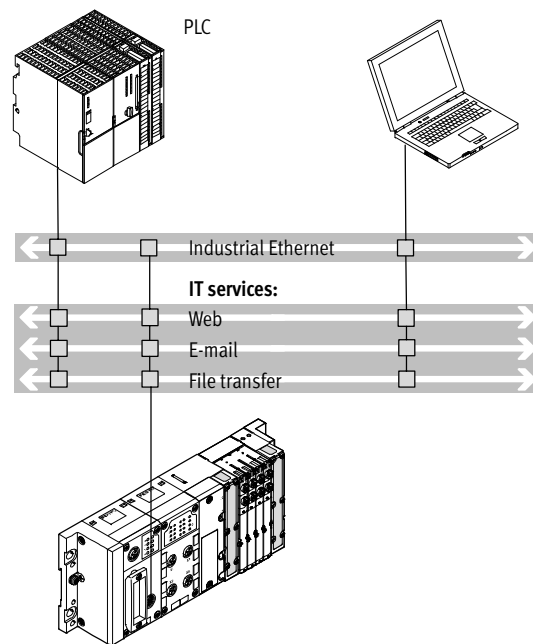

- Connection to a higher-order controller directly via EtherNet/IP, Modbus/TCP, POWERLINK, EtherCAT or PROFINET
- No preprocessing
- Monitoring via Ethernet and web applications
- Up to 300 I/Os

Note

Every electrical connection can be combined with an appropriate number of I/O modules and/or pneumatic components, depending on its address capacity.

Likewise, every pneumatic variant of the CPX terminal can be operated with every electrical connection variant.

Terminal CPX

Key features

Variants of the CPX terminal controller (with preprocessing in the control block)

Control block

The optional Front End Controllers CPX-CEC enable access via Ethernet, in parallel with a bus node, as

well as autonomous preprocessing. Access via Modbus/TCP and EasyIP is also possible.

Commissioning, programming and diagnostics using the Festo software tool FST 4.1 with hardware configurator.

With control block in stand-alone mode

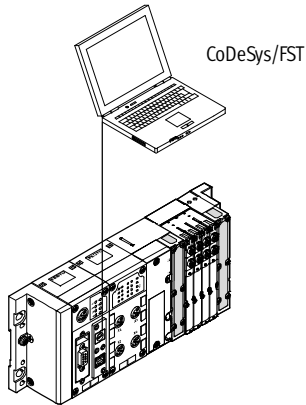

- Decentralised controller with direct machine mounting
- Interaction options via CPX-MMI or Front End Display
- Downloading of programs via Ethernet (or via the programming interface)
- Supports full expansion of all CPX peripherals
- More than 300 I/Os

Beneficial application areas:

- Stand-alone individual workstations
- Interlinked, stand-alone sub-systems
- Automation using IT technology

With control block in Festo EasyIP mode

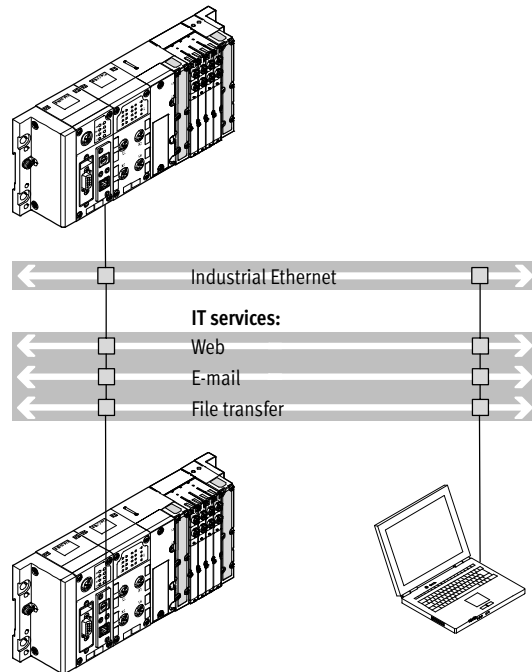

- Fast preprocessing of the CPX peripherals in the control block
- Exchange of any data between the control blocks via EasyIP
- Remote diagnostics

- No higher-order controller is required
- More than 300 I/Os per CPX control block

Terminal CPX

Key features

Variants of the CPX terminal controller (with preprocessing in the control block)

With control block as remote controller on Ethernet

Remote controller on Ethernet as the preprocessing unit for decentralised, stand-alone subsystems using IT technology.

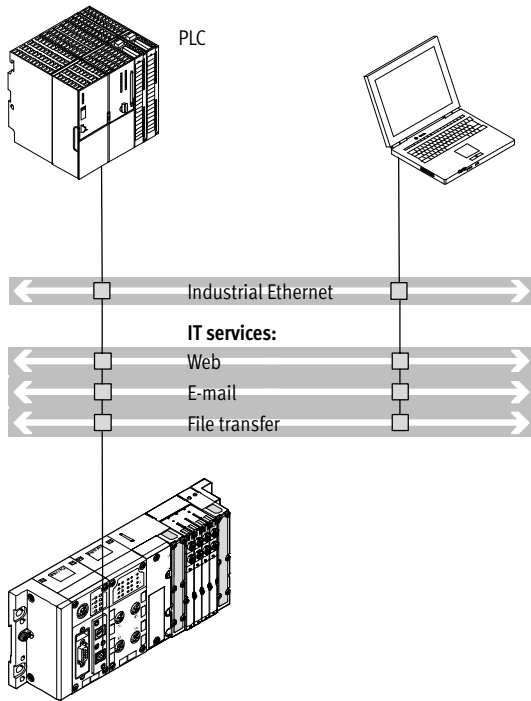

- Connection to a higher-order controller via Ethernet, no further bus node is required
- Monitoring via Ethernet and web applications

- Preprocessing of the CPX peripherals by CPX control block
- More than 300 I/Os

With control block as remote controller on the fieldbus

Fieldbus remote controller (combination with bus nodes for INTERBUS, PROFIBUS DP, PROFINET, CANopen, DeviceNet, CC-Link, POWERLINK, Sercos III or EtherCAT) as the preprocessing unit for decentralised, stand-alone subsystems.

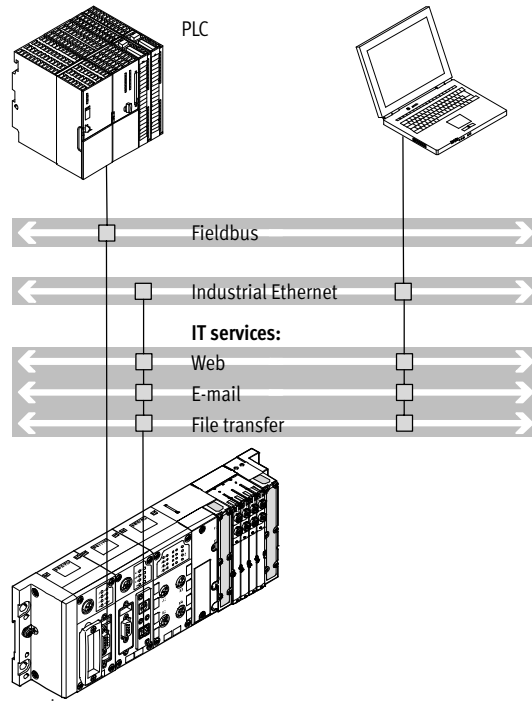

- Fast preprocessing of the CPX peripherals in the control block
- Communication with higher-order controller via fieldbus
- Optional additional monitoring via Ethernet and web applications

- Downloading of programs via programming interface
- More than 300 I/Os, bus node is only used for communication with the higher-order PLC
- Two bus nodes for redundant communication configuration

Terminal CPX

Key features

Variants of the CPX terminal controller (with preprocessing in the control block)

With control block as CANopen fieldbus master

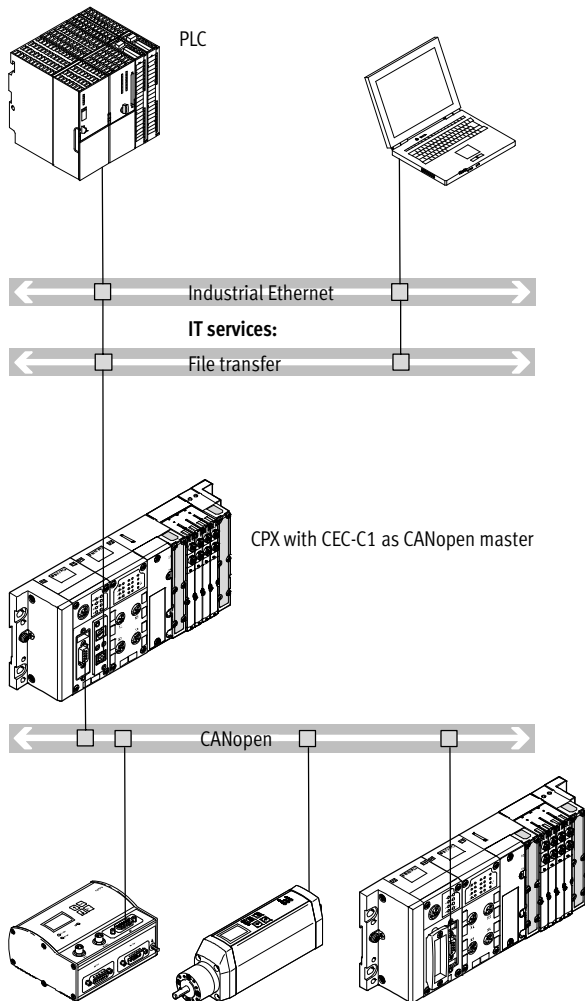

Properties:

- Connection to a higher-order controller via Ethernet, no further bus node is required
- Monitoring via Ethernet
- Preprocessing of the CPX peripherals by CPX control block
- More than 300 I/Os
- Up to 128 stations with repeater technology on CANopen

Operating modes:

- Remote controller on Ethernet
- Control block in Festo EasyIP mode

Terminal CPX

Key features



Connection of inputs and outputs to the CPX terminal

Digital and analogue CPX I/O modules

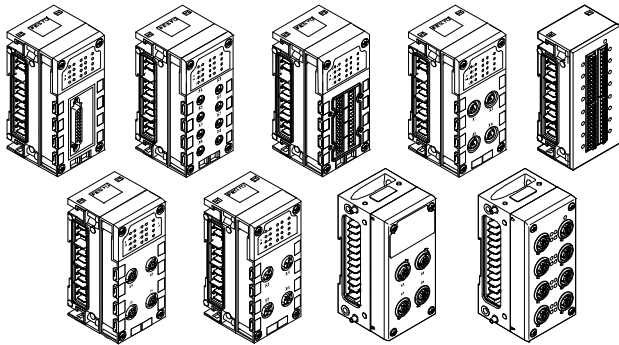

Electrical connection

The connection technology for sensors and additional actuators offers a wide range of digital and analogue input and output modules and is freely selectable – as appropriate to your standard or application. Plastic or metal connection blocks can be combined as required:

- Metal design
 - M12-5POL
- Plastic design:
 - M12-5POL
 - M12-5POL with quick lock and metal thread
 - M12-8POL
 - M8-3POL
 - M8-4POL
 - Sub-D
 - Harax®
 - CageClamp® (with cover also to IP65, IP67)
 - Screw terminal / spring-loaded terminal

With CPX-CP interface

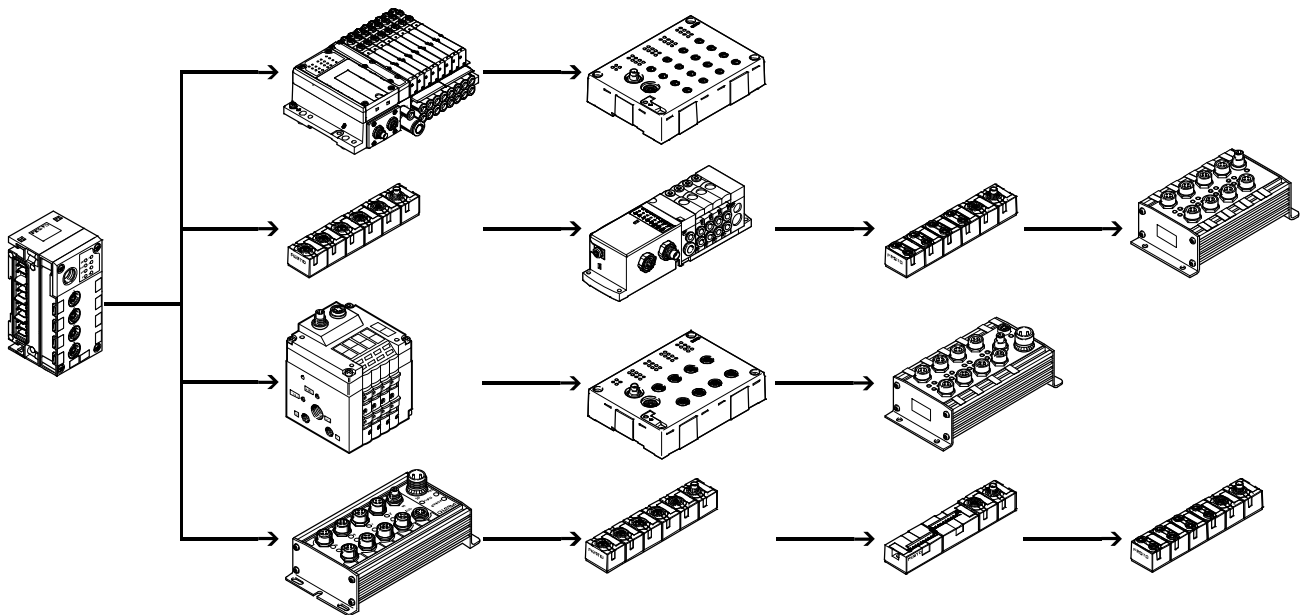

- Up to 4 strings per CP interface possible
- Up to 4 subordinate CP modules can be combined in one string

- Up to 32 I/Os can be connected per string
- Modules with M8, M12 and terminal connection

Several CP interface modules can be combined in one CPX terminal (depending on the controller used).

Combination of centralised CPX I/O modules and decentrally mounted I/O modules of the CPI installation system.

Combined centralised and decentralised electrical connection (valve terminal with CP interface/output module)

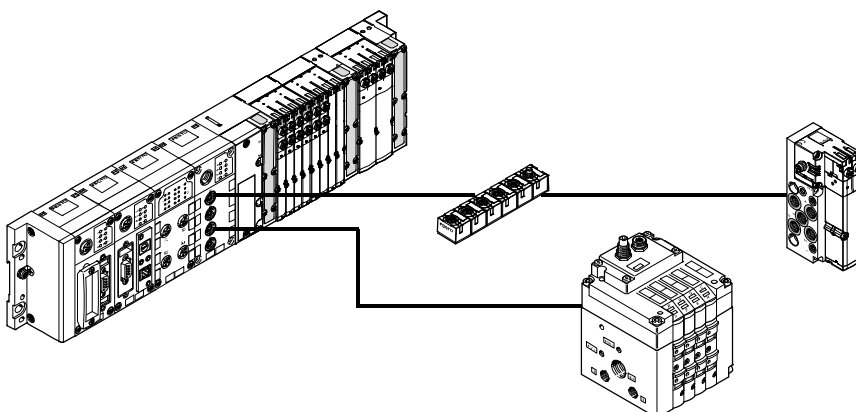

- Scalable to different requirements within a system
- One control interface in the system, reduces installation complexity with closely and widely spaced actuators
- Enables an optimum electrical and pneumatic control chain

Terminal CPX

Key features

Connection of inputs and outputs to the CPX terminal with CPX-CTEL interface

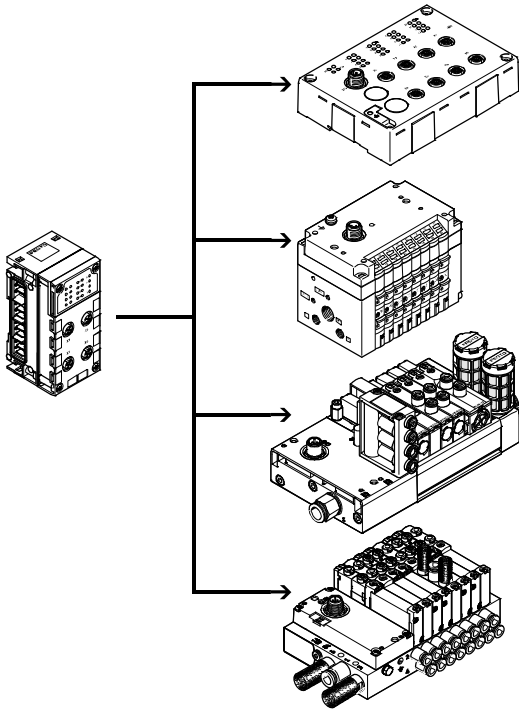

- Up to 4 devices with individual electronic fuse protection per CPX-CTEL master
- Max. 64 inputs/64 outputs per I-Port interface
- The maximum length of a string is 20 m
- Input modules with 16 digital inputs (3-pin M8 and 5-pin M12 connection technology)
- Valve terminals with I-Port interface (up to 48 solenoid coils, different valve functions)

Several CPX-CTEL masters can be combined in one CPX terminal (depending on the controller used). Combination of central CPX I/O modules and decentrally mounted I/O modules with I-Port interface.

With CPX-CTEL-2 interface

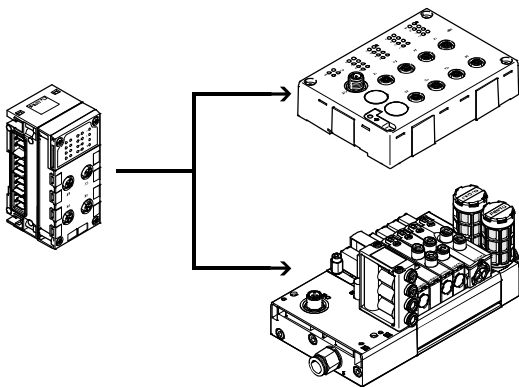

- Up to 2 individual electronically protected IO-Link devices per CPX-CTEL-2 interface
- Max. 16-byte inputs/16-byte outputs per IO-Link device
- The maximum length of a string is 20 m

Several CPX-CTEL-2 interface modules can be combined on one CPX terminal (depending on the controller used). Combination of central CPX I/O modules and decentrally mounted I/O modules with IO-Link interface.

Terminal CPX

Key features

Connection of inputs and outputs to the CPX terminal

Electrical drives with CPX-CM-HPP axis interface

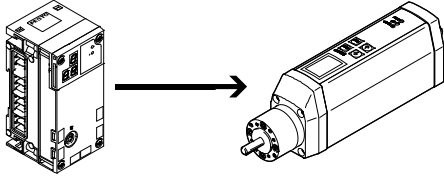

- Max. 4 individual electric axes, per CPX-CM-HPP
- No programming required
- Standardised communication with the drives via the Festo Handling and Positioning Profile (FHPP)
- The control component is independent of the bus node used
- Quick configuration and diagnostics via the operator unit CPX-MMI

Pneumatic drives with CPX-CMAX/CMPX

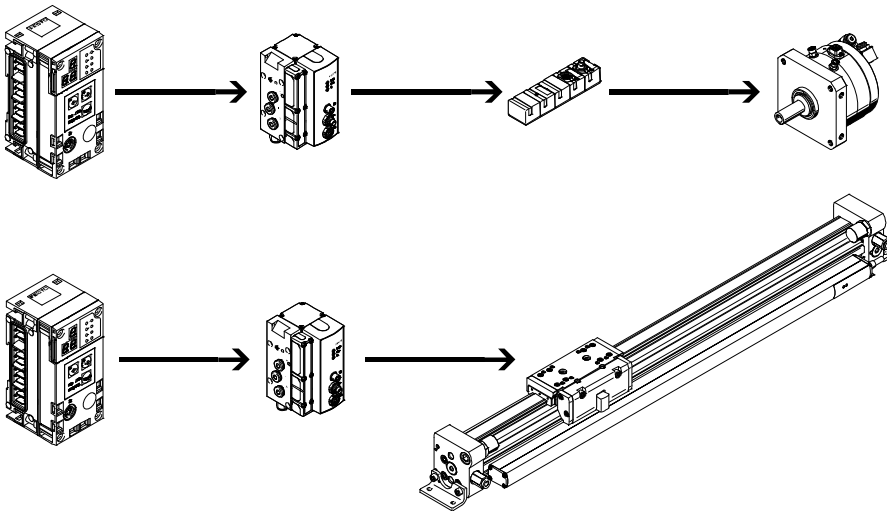

CPX-CMAX

- Position and force control, directly actuated or selected from one of 64 configurable positioning profiles.
- Configurable record continuation enables simple functional sequences to be realised.
- The auto-identification function identifies each station with its device data on the controller.
- Actuation of a brake or clamping unit via the proportional directional control valve VPWP.
- Up to 7 modules (max. 7 axes) can be operated in parallel and independently of each other.
- Commissioning via the Festo configuration software FCT or via fieldbus.

CPX-CMPX

- Fast travel between the mechanical end stops of the cylinder, stopping gently and without impact in the end position.
- Fast commissioning via control panel, fieldbus or handheld unit.
- Improved downtime control.
- Actuation of a brake or clamping unit via the proportional directional control valve VPWP.
- Max. 9 end-position controllers can be actuated depending on the fieldbus.
- All system data can be read and written via the fieldbus, including the mid positions, for example.

Terminal CPX

Key features

FESTO

Ordering

The CPX terminal with valve terminal is fully assembled according to your order specifications and individually tested. The finished valve terminal consists of the electrical peripherals including the desired actuation and the selected components of the VTSA (ISO), VTSA-F, MPA-S or MPA-L modules.

The CPX terminal with valve terminal is ordered using two separate order codes. One order code defines the electrical peripherals type CPX, while the other specifies the pneumatic components of the valve terminal. The electrical peripherals type CPX can also be configured without a valve terminal and can be used on a fieldbus. For this order, only the order code for the electrical peripherals is required.

The order lists for the pneumatic components can be found on

- ➔ Internet: vtsa (valve terminal VTSA)
- ➔ Internet: vtsa-f (valve terminal VTSA-F)
- ➔ Internet: mpa-s (valve terminal MPA-S)
- ➔ Internet: mpa-l (valve terminal MPA-L)

The order lists for the CP/CPI components can be found on

- ➔ Internet: ctec (CPI installation system)

The order lists for the CTEU/CTEL components can be found on

- ➔ Internet: cteu (I-Port interface/IO-Link)

Terminal CPX

Peripherals overview

FESTO

Complete overview of modules

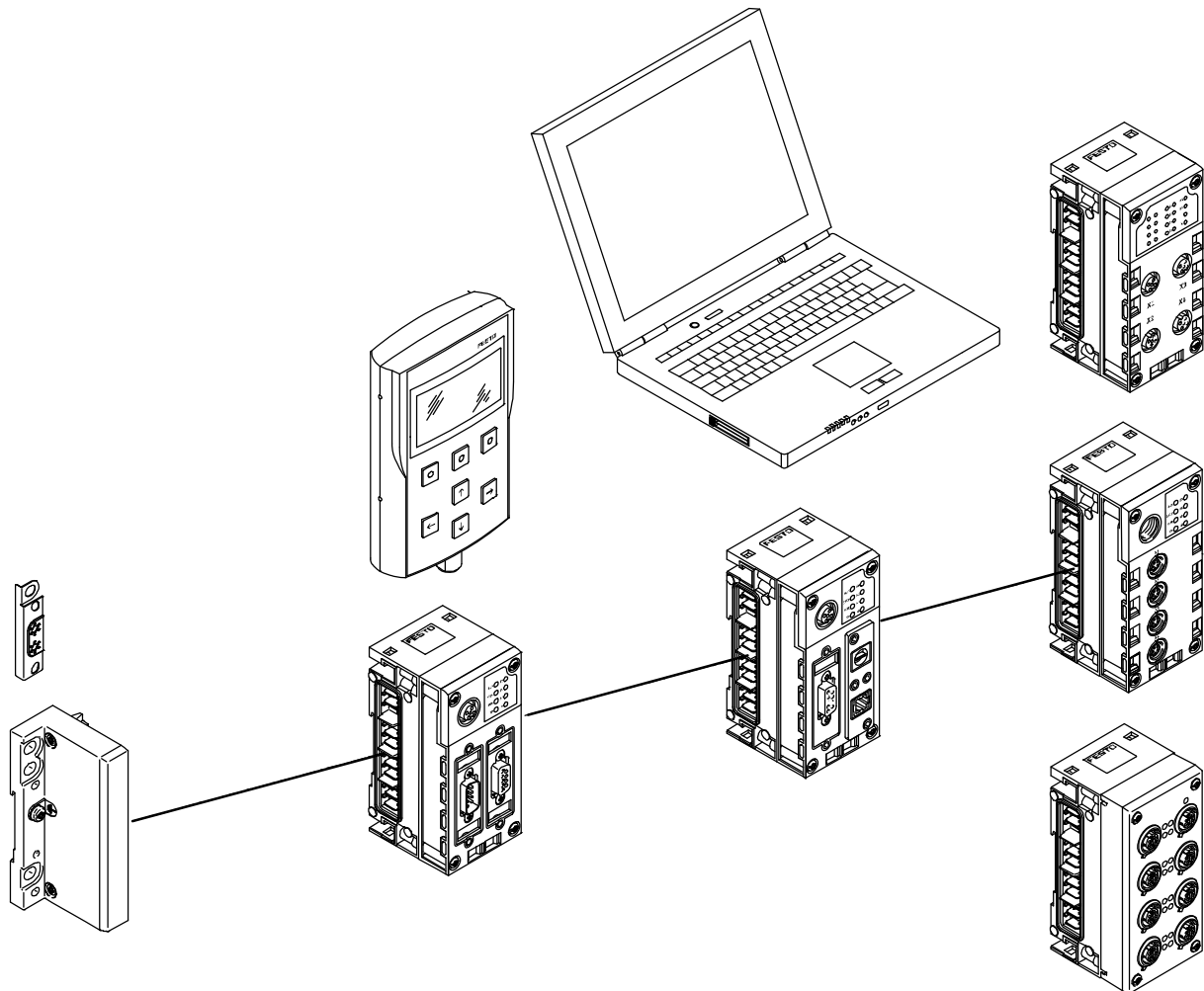

End plate

- Mounting holes for wall mounting
- Functional earth connection
- Special earthing plate for safe and easy connection to the machine bed or H-rail
- External power supply for the entire system

Bus node

- Fieldbus/Industrial Ethernet connection using various types of connection technology
- Setting of fieldbus parameters via DIL switch
- Display of fieldbus and peripheral equipment status via LED
- PROFINET to AIDA standard in metal housing, fast start-up

Operator unit

- Connection to bus nodes or control block
- Display and modification of parameter settings
- Plain-text display for texts, messages (e.g. individual channel diagnostics, condition monitoring), menus, etc.

Control block

- Pre-processing, stand-alone controller or remote unit CPX-CEC
- Connection via Ethernet TCP/IP or Sub-D programming interface
- Setting of operating modes via DIL switch and program selection via rotary switch
- CPX-CMX products for controlling axes

Web monitor

- Website integrated in the CPX terminal
- Dynamic status display
- Online diagnostics
- SMS/e-mail alert

CP interface/CTEL interface

- Interfaces for decentralised installation systems, thus optimising the pneumatic control chains (short tubes/short cycle times)
- Actuation for I/O modules and valve terminals
- Power supply and bus interface via the same cable

Input/output modules

- Combination of
- Interlinking block
 - Electronics module
 - Connection block

Terminal CPX

Peripherals overview

FESTO

Complete overview of modules

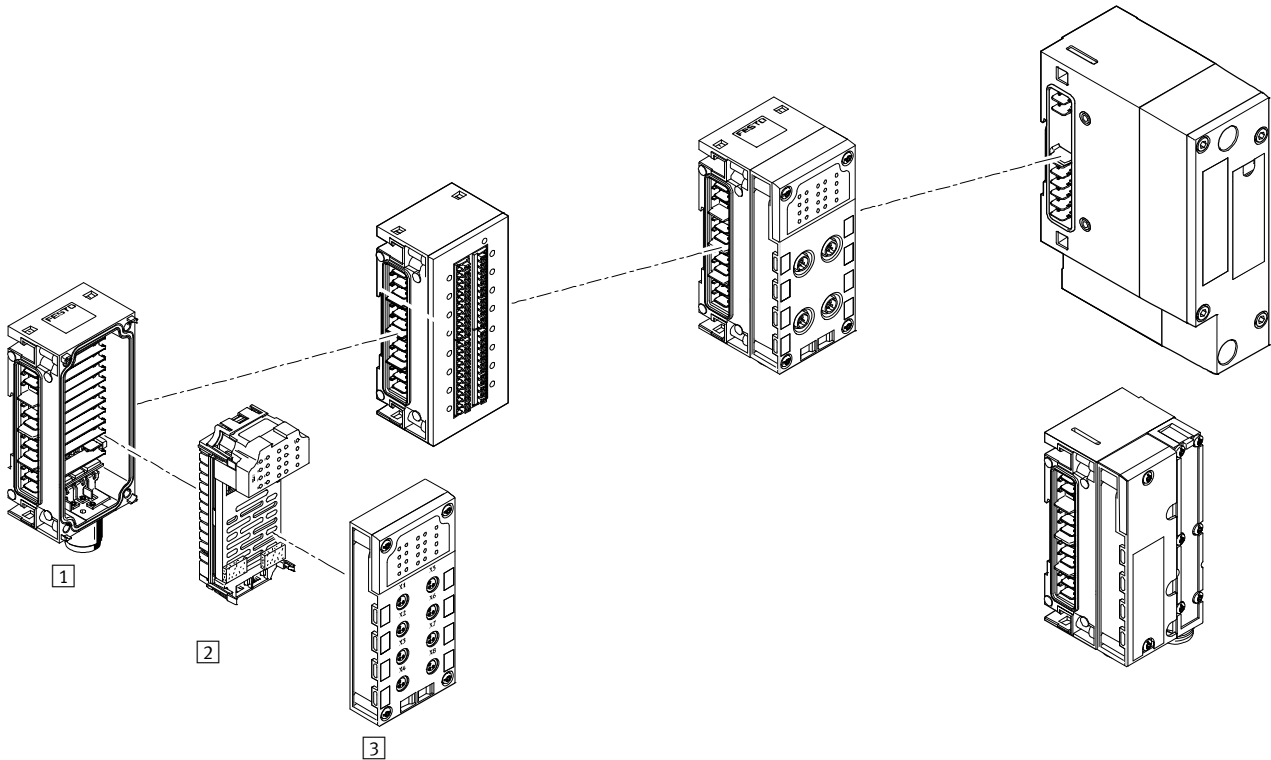

Input/output modules

1 Interlinking block

- Internal linking of the power supply and serial communication
- External power supply for the entire system
- Additional power supply for outputs or valves
- Connection accessories for M18, 7/8" or AIDA push-pull
- Plastic design: linking with tie rods
- Metal design: individual linking with M6 screws, individually expandable

2 Electronics module

- Digital inputs for connecting the sensors
- Digital outputs for activating additional actuators
- Analogue inputs
- Temperature inputs (analogue)
- Analogue outputs
- PROFIsafe input module for safety-oriented sensor technology
- PROFIsafe shut-off module with two digital outputs for shutting off the supply voltage for valves

3 Connection block

- Choice of 8 connection technology variants
- Protection class IP65, IP67 or IP20
- Can be combined with the electronics modules
- M8/M12/Sub-D/quick connection
- M8/M12/Sub-D, etc. connecting cables
- Modular system for M8/M12 connecting cables
- M12 connection technology for the metal design

Pneumatics interface

- MPA-S
- MPA-L
- VTSA/VTSA-F

Terminal CPX

Peripherals overview

FESTO

Individual overview of modules

Bus node

→ page 67

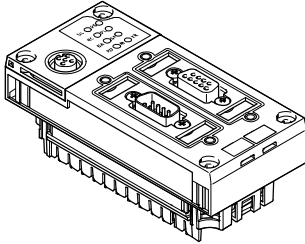

Bus node for

- PROFIBUS DP
- INTERBUS
- DeviceNet
- CANopen
- CC-LINK

- Ethernet/IP
- PROFINET
- POWERLINK
- EtherCAT
- Sercos III

Control block

→ page 60

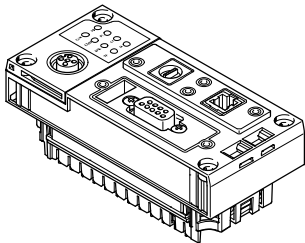

CPX-CEC

- Programming with CODESYS
- Ethernet interface
- Modbus/TCP
- EasyIP
- CANopen master

CP interface

→ page 124

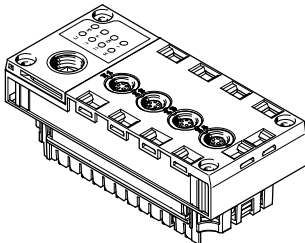

Interface CPX-CP

- 4 CP strings
- Max. 4 modules per string
- 32 inputs/32 outputs per string
- CPI functionality

CTEL interface

→ page 129

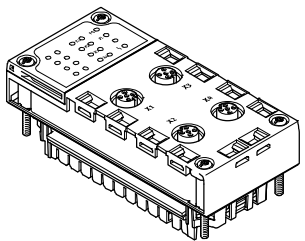

CPX-CTEL interface

- CTEL master
- Max. 4 devices with individual electronic fuse protection
- Max. 64 inputs/64 outputs per I-Port interface
- The maximum length of a string is 20 m

Electrical interface CPX-CTEL-2

→ page 135

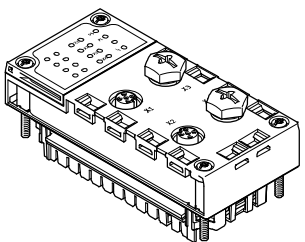

Interface CPX-CTEL-2

- Master for IO-Link
- Max. 2 devices with individual electronic protection
- Process data length of the inputs and outputs is limited to 16 bytes for inputs and 16 bytes for outputs per port
- The maximum length of a string is 20 m

Terminal CPX

Peripherals overview

Individual overview of modules

Modules for actuating electric drive units

→ page 140

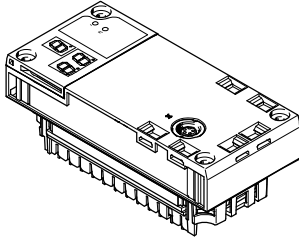

CPX-CM-HPP

- Axis interface
- CAN bus for up to 4 individual electric axes

Modules for controlling pneumatic drive units

→ page 143

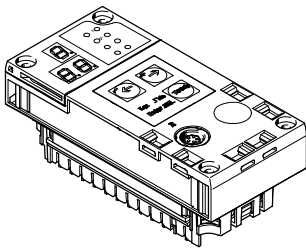

CPX-CMAX

- Axis controller
- Position and force control
- 64 configurable positioning records
- Auto-identification
- Control of a brake or clamping unit via the proportional directional control valve VPWP

CPX-CMPX

- End-position controller
- Fast travel between the mechanical end stops of the cylinder
- Smooth travel into the end position
- Improved control of downtime
- Control of a brake via the proportional directional control valve VPWP

CPX-CMIX

- Measuring module
- CAN input (Festo specification) for measuring signal
- Recording of the absolute position values or speed values of the connected drive

Plastic connection block

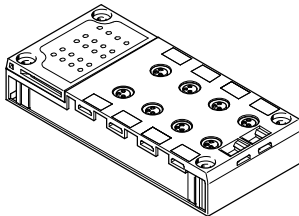

Direct machine mounting
(protection class IP65, IP67)

- M8-3POL
- M8-4POL
- M12-5POL
- M12-5POL quick lock, metal thread screened
- M12-8POL
- Sub-D
- Quick connector
- Spring-loaded terminal with cover

Protected fitting space
(protection class IP20)

- Spring-loaded terminal

Screening concept

- Optional screening plate for connection blocks with M12 connection technology

Metal manifold block

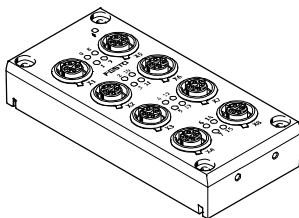

Direct machine mounting
(protection class IP65, IP67)

- M12-5POL

Connection block including electronics module and interlinking block

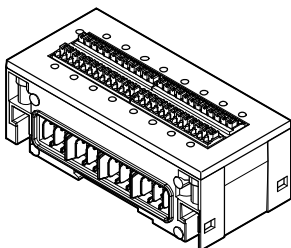

Installation in the control cabinet
(protection class IP20)

- Plastic connection block
- Spring-loaded terminal
- Digital input module with 16 inputs
- Digital I/O module with 8 inputs and 8 outputs

Individual overview of modules

Connection block for HART input/output module

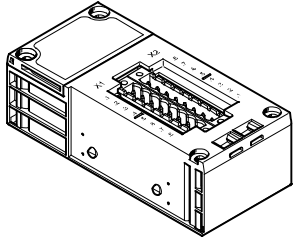

- Direct machine mounting
(connection block to IP65)
- M12-4POL

- Protected fitting space
(connection block to IP20)
- Screw terminal
 - Spring-loaded terminal

Digital electronics module for inputs/outputs

→ page 152

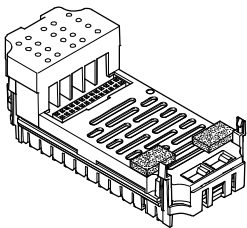

- Digital inputs
- 4 digital inputs
 - 8 digital inputs NPN
 - 8 digital inputs PNP
 - 8 digital inputs PNP with individual channel diagnostics
 - 16 digital inputs
 - 16 digital inputs with individual channel diagnostics

- Digital outputs
- 4 digital outputs (1 A per channel, individual channel diagnostics)
 - 8 digital outputs (0.5 A per channel, individual channel diagnostics)
 - 8 digital outputs (2.1 A/50 W lamp load per channel pair, individual channel diagnostics)

- Multi I/O modules
- 8 digital inputs and 8 digital outputs
 - 2 digital inputs (counter channels, connection to various encoders) and 2 digital outputs (directly controlled by the input values)

Analogue electronics module for inputs/outputs

→ page 190

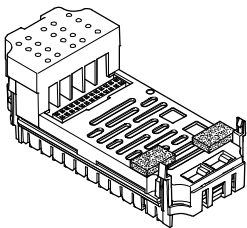

- Analogue inputs
- 2 analogue inputs (0 ... 10 V DC, 0 ... 20 mA, 4 ... 20 mA)
 - 4 analogue inputs (1 ... 5 V, 0 ... 10 V, -5 ... +5 V, -10 ... +10 V, 0 ... 20 mA, 4 ... 20 mA, -20 ... +20 mA)
 - 4 analogue inputs with HART protocol

- Analogue temperature inputs
- 4 analogue inputs for temperature measurement (Pt100, Pt200, Pt500, Pt1000, Ni100, Ni120, Ni500, Ni1000)
 - 4 analogue inputs for temperature measurement (thermocoupler and PT1000 sensor for cold-junction compensation)

- Analogue outputs
- 2 analogue outputs (0 ... 10 V DC, 0 ... 20 mA, 4 ... 20 mA)

PROFIsafe input module

→ page 157

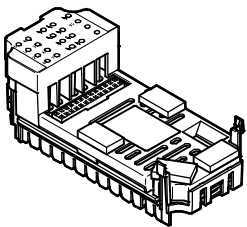

- Digital inputs
- 8 digital inputs
 - 11 function modes
 - 5 independent clock outputs

PROFIsafe shut-off module

→ page 209

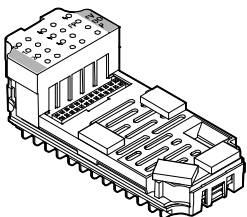

- Digital outputs
- 2 digital outputs
 - Supply voltage for valves can be shut off

Terminal CPX

Peripherals overview

Individual overview of modules

Analogue electronics module for pressure inputs

→ page 195

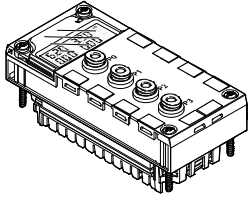

Analogue inputs

- 4 analogue supply ports (0 ... 10 bar, -1 ... +1 bar)

Plastic interlinking block – Interlinking by means of tie rods

→ page 218

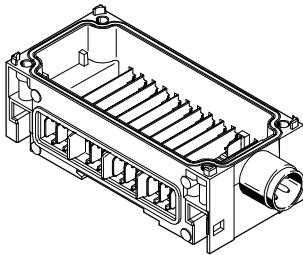

System linking

- Different voltages for supplying the modules
- Serial communication between the modules

In addition to system linking, power supply for the

- electronics plus sensors (16 A)
- valves plus actuators (16 A)

Power supply for the

- valves (16 A per supply)

System supply

- M18 4-pin
- 7/8" 4-pin or 5-pin

Additional power supply

In addition to system linking, power supply for the

- actuators (16 A per supply)

Expandability

- Can be expanded using an interlinking block with tie-rod extension CPX-ZA-1-E

Metal interlinking block – Individual linking

→ page 218

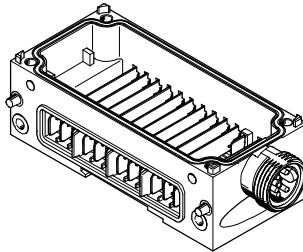

System linking

- Different voltages for supplying the modules
- Serial communication between the modules

In addition to system linking, power supply for the

- electronics plus sensors (16 A)
- valves plus actuators (16 A)

Power supply for the

- valves (16 A per supply)

System supply

- 7/8" 4-pin or 5-pin
- AIDA push-pull

Additional power supply

In addition to system linking, power supply for the

- actuators (16 A per supply)

Expandability

- Can be expanded as required by up to 10 interlinking blocks

- Note

Plastic interlinking blocks (tie rods) and metal interlinking blocks (individual linking) cannot be combined due to their different interlinking systems.

- Note

The 7/8" supply is subject to the following restriction due to the available accessories:

- 5-pin 8 A
- 4-pin 10 A

- Note

The usage of appropriate interlinking blocks (CPX-...-VL) is required for use in ATEX environments as per approval certificate (→ page 47). The maximum supply is limited to 8 A for these modules.

Individual overview of modules

Pneumatic interface MPA-S

→ page 232

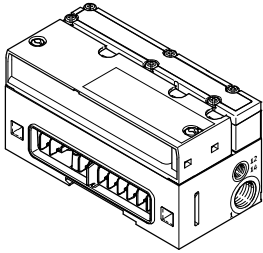

Valve terminal

- MPA1 (360 l/min)
- MPA2 (700 l/min)
- Up to 128 solenoid coils
- Up to 16 modules can be configured
- For CPX plastic design
- For CPX metal design
- Actuation of pressure sensors
- Proportional pressure regulators
- Pressure sensors
- Proportional pressure regulators

Pneumatic interface MPA-L

→ page 234

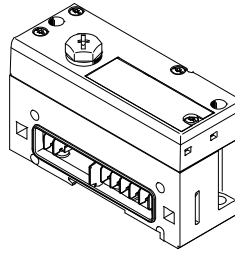

Valve terminal

- MPA1 (360 l/min)
- MPA14 (670 l/min)
- MPA2 (870 l/min)
- Up to 32 solenoid coils
- For CPX plastic design

Pneumatic interface VTSA/VTSA-F

→ page 235

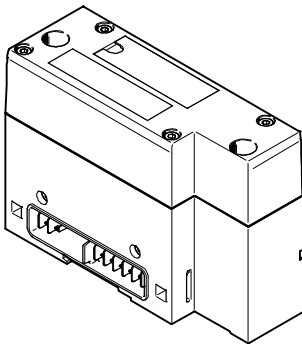

Valve terminal (valve flow rate according to width)

- 18 mm (700 l/min)
- 26 mm (1350 l/min)
- 42 mm (1300 l/min)
- 52 mm (2900 l/min)
- 65 mm (4000 l/min)
- Max. 32 valve positions/
max. 32 solenoid coils
- For CPX plastic design
- For CPX metal design

Terminal CPX

Peripherals overview

Individual overview of modules

End plate for plastic/metal design

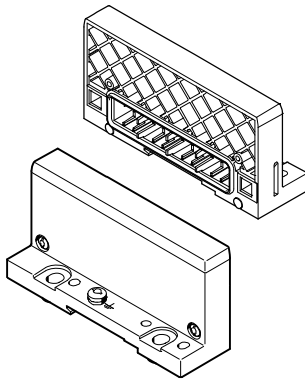

End plate

- Left-hand
- Right-hand (for using of the CPX terminal without valves)

End plate with system power supply

→ page 214

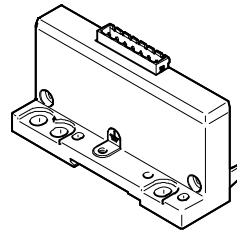

End plate

- Left-hand
- For plastic design
- Different voltages for supplying the CPX terminal

End plate with extension

→ page 216

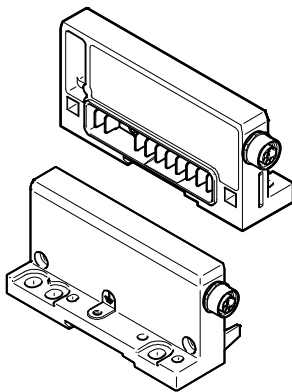

End plate

- Left-hand
- Right-hand
- Enables the CPX terminal to be separated into two interconnected units (series)
- Simplifies control cabinet installation
- For plastic or metal design

Earthing plate (for end plate for plastic design)

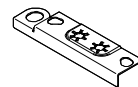

Earthing plate

- For safe and easy connection to the machine bed or H-rail, suitable for right-hand and left-hand end plate
- Assembly and earthing in a single processing step, which means:
 - 50% time saving
 - No additional material required

Terminal CPX

Peripherals overview

General basic data and guidelines

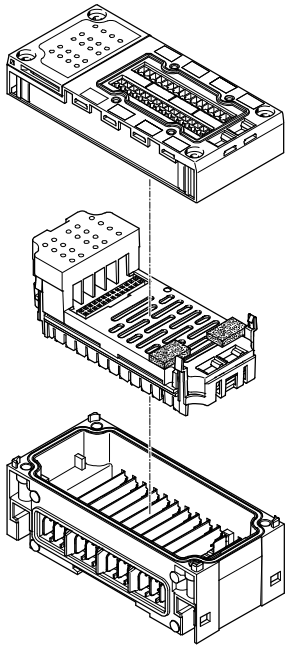

Max. 11 modules in total:

- One bus node and/or one control block, freely positionable
- Up to 9 additional input/output modules, freely positionable
- An additional pneumatic interface always positioned as the last module on the right-hand side
 - With VTSA and VTSA-F: fixed operating range, set using DIL switch
 - With MPA-S: 16 MPA modules can be configured
 - With MPA-L: fixed operating range, set using rotary switch
- Address capacity max. 512 inputs and 512 outputs, depending on bus node or control block
- One interlinking block with system supply
- Multiple interlinking blocks with additional power supply, always positioned to the right of the interlinking block with system supply
- The connection blocks can, with just a few exceptions, be freely combined with the electronics modules for inputs/outputs, either in metal or plastic (→ table below)
- The electronics modules for inputs/outputs can be combined with various interlinking blocks
- Plastic interlinking blocks (tie rods) and metal interlinking blocks (individual linking) cannot be combined due to their different interlinking systems

Combinations of connection blocks and digital input modules

	Digital electronics modules							
	CPX-4DE	CPX-8DE	CPX-16DE	CPX-L-16DE	CPX-M-16DE-D	CPX-8DE-D	CPX-8NDE	CPX-F8DE-P
Connection blocks, plastic design								
CPX-AB-8-M8-3POL	■	■	–	–	–	■	■	–
CPX-AB-8-M8X2-4POL	–	–	■	–	–	–	–	–
CPX-P-AB-4XM12-4POL	–	–	–	–	–	–	–	–
CPX-AB-4-M12x2-5POL	■	■	–	–	–	■	■	–
CPX-AB-4-M12x2-5POL-R	■	■	–	–	–	■	■	–
CPX-AB-8-M12X2-5POL	–	–	–	–	■	–	–	–
CPX-AB-4-M12-8POL	–	–	–	–	–	–	–	–
CPX-AB-8-KL-4POL	■	■	■	–	–	■	■	■
CPX-P-AB-2XKL-8POL	–	–	–	–	–	–	–	–
CPX-AB-1-SUB-BU-25POL	■	■	■	–	–	■	■	–
CPX-AB-4-HAR-4POL	■	■	–	–	–	■	■	–
CPX-AB-ID-P	–	–	–	–	–	–	■	■
Connection blocks, metal design								
CPX-M-AB-4-M12X2-5POL	■	■	–	–	–	■	■	■
CPX-M-AB-4-M12X2-5POL-T	–	–	–	–	–	–	■	■
CPX-M-AB-8-M12X2-5POL	–	–	–	–	■	–	–	–

Terminal CPX

Peripherals overview

Combinations of connection blocks and digital output modules/multi I/O modules							
	Digital electronics modules						
	CPX-4DA	CPX-8DA	CPX-8DA-H	CPX-8DE-8DA	CPX-L-8DE-8DA	CPX-2ZE2DA	CPX-FVDA-P2
Connection blocks, plastic design							
CPX-AB-8-M8-3POL	■	■	-	-	-	-	-
CPX-AB-8-M8X2-4POL	■	■	■	-	-	-	-
CPX-P-AB-4XM12-4POL	-	-	-	-	-	-	-
CPX-AB-4-M12x2-5POL	■	■	-	-	-	-	-
CPX-AB-4-M12x2-5POL-R	■	■	■	-	-	-	-
CPX-AB-8-M12X2-5POL	-	-	-	-	-	-	-
CPX-AB-4-M12-8POL	-	-	-	■	-	-	-
CPX-AB-8-KL-4POL	■	■	■	■	-	-	■
CPX-P-AB-2XKL-8POL	-	-	-	-	-	-	-
CPX-AB-1-SUB-BU-25POL	■	■	■	■	-	-	-
CPX-AB-4-HAR-4POL	■	■	-	-	-	-	-
CPX-AB-ID-P	-	-	-	-	-	-	-
Connection blocks, metal design							
CPX-M-AB-4-M12X2-5POL	■	■	■	-	-	-	■
CPX-M-AB-4-M12X2-5POL-T	-	-	-	-	-	-	-
CPX-M-AB-8-M12X2-5POL	-	-	-	-	-	-	-

Combinations of connection blocks and analogue electronics modules for inputs/outputs								
	Analogue electronics modules							
	CPX-4AE-4AA-H	CPX-2AE-U-I	CPX-4AE-U-I	CPX-4AE-I	CPX-2AA-U-I	CPX-4AE-P	CPX-4AE-T	CPX-4AE-TC
Connection blocks, plastic design								
CPX-AB-8-M8-3POL	-	-	-	-	-	-	-	-
CPX-AB-8-M8X2-4POL	-	-	-	-	-	-	-	-
CPX-P-AB-4XM12-4POL	■	-	-	-	-	-	-	-
CPX-AB-4-M12x2-5POL	-	■	■	■	■	-	■	■
CPX-AB-4-M12x2-5POL-R	-	■	■	■	■	-	■	■
CPX-AB-8-M12X2-5POL	-	-	-	-	-	-	-	-
CPX-AB-4-M12-8POL	-	-	-	-	-	-	-	-
CPX-AB-8-KL-4POL	-	■	■	■	■	-	■	■
CPX-P-AB-2XKL-8POL	■	-	-	-	-	-	-	-
CPX-AB-1-SUB-BU-25POL	-	■	■	■	■	-	-	-
CPX-AB-4-HAR-4POL	-	-	-	-	-	-	■	-
CPX-AB-ID-P	-	-	-	-	-	-	-	-
Connection blocks, metal design								
CPX-M-AB-4-M12X2-5POL	-	■	■	■	■	-	■	■
CPX-M-AB-4-M12X2-5POL-T	-	-	-	-	-	-	-	-
CPX-M-AB-8-M12X2-5POL	-	-	-	-	-	-	-	-

Terminal CPX

Key features – Electrical components

Electrical connection – Connection block

CPX-AB-8-M8-3POL with M8-3POL connection

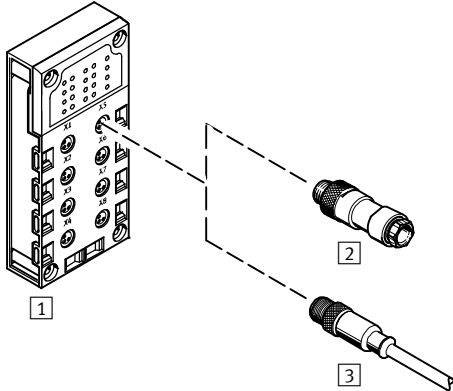

- Compact for pre-assembled individual connection
- 8 sockets
- 3-pin design for connecting 1 channel per socket

-  - Note

Festo delivers pre-assembled M8/M12 connecting cables (NEBU modular system) on request:

- Tailored to the application
- Perfect fit
- Saves installation space

Combination of connection block and electrical connection technology

Connection block	Connection technology	Plug connector/connecting cable	Selectable connection technology
1 CPX-AB-8-M8-3POL	Socket, M8, 3-pin	2 SEA-GS-M8	Solder lugs
		2 SEA-3GS-M8-S	Screw terminals
		3 NEBU-...-M8G3 (modular system for choice of connecting cables)	Socket, M8, 3-pin
			Socket, M8, 4-pin
			Socket, M12, 5-pin
			Open cable end

Terminal CPX

Key features – Electrical components

Electrical connection – Connection block

CPX-AB-8-M8X2-4POL with M8-4POL connection

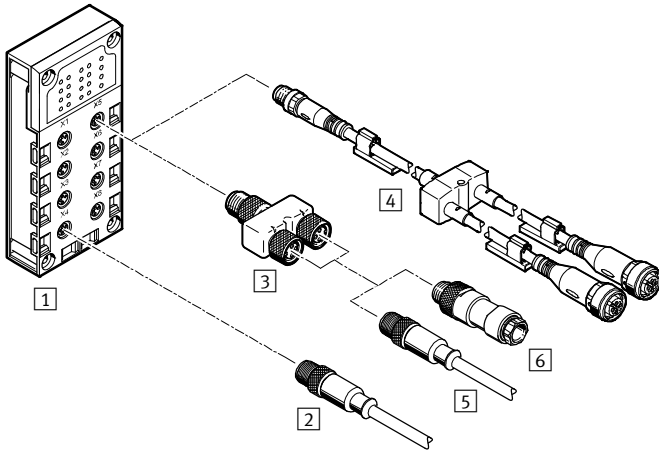

- Compact for pre-assembled individual connection
- 8 sockets
- 4-pin design for connecting 2 channels per socket

Combination of connection block and electrical connection technology							
Connection block	Connection technology	Plug connector/ connecting cable	Selectable connection technology	Plug connector/ connecting cable	Selectable connection technology		
1 CPX-AB-8-M8X2-4POL	Socket, M8, 4-pin	2 NEBU-...-M8G4 (modular system for choice of connecting cables)	Socket M8, 3-pin	–	–		
			Socket, M8, 4-pin	–	–		
			Socket, M12, 5-pin	–	–		
			Open cable end	–	–		
		3 NEDY-L2R1-V1-M8G3-N-M8G4 (T-adaptor)	1x plug M8, 4-pin to	6 SEA-GS-M8	Solder lugs		
			2x socket M8, 3-pin	6 SEA-3GS-M8-S	Screw terminals		
		4 NEDY-... (modular system for choice of sensor/actuator distributors)	2x socket, M8, 3-pin 2x socket, M8, 4-pin 2x socket, M12, 5-pin 2x socket, type A 2x socket, type B 2x socket, type C 2x socket, connection pattern H 2x socket, connection pattern ZB 2x socket, connection pattern ZC 2x open cable end	5 NEBU-...-M8G3 (modular system for choice of connecting cables)	Socket, M8, 3-pin	–	–
					Socket, M8, 4-pin	–	–
					Socket, M12, 5-pin	–	–
					Open cable end	–	–
					–	–	–
					–	–	–
					–	–	–
					–	–	–

Terminal CPX

Key features – Electrical components

FESTO

Electrical connection – Connection block

CPX-AB-4-M12x2-5POL and CPX-AB-4-M12x2-5POL-R with M12-5POL connection

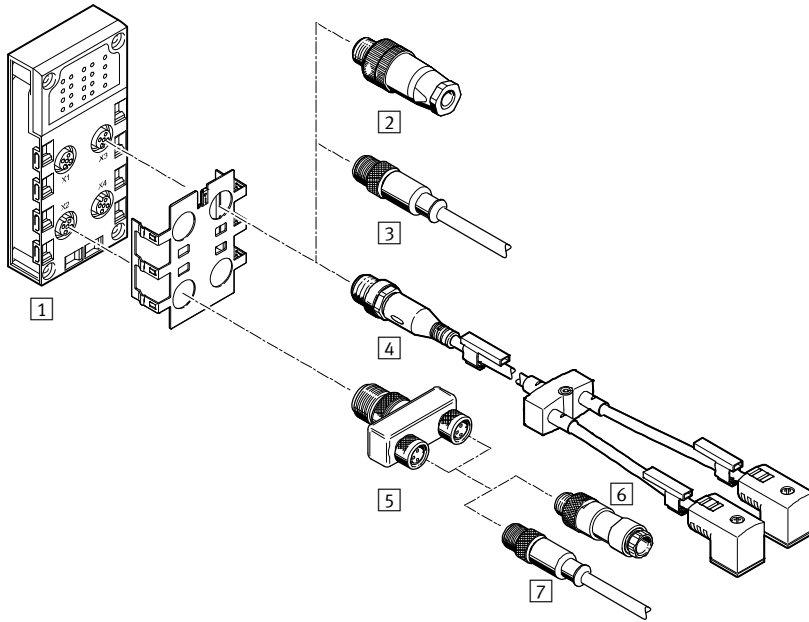

- Suitable for self-assembly and sturdy with 2 channels per connection
- 4 sockets
- 5-pin design per socket
- Version ...-R with quick lock technology and metal thread for screening
- With two channels per connection, the corresponding input signals can be easily connected via a T-adapter and conventional connecting cables with M8 connection

Terminal CPX

Key features – Electrical components

Combination of connection block and electrical connection technology					
Connection block	Connection technology	Plug connector/ connecting cable	Connection technology	Plug connector/ connecting cable	Connection technology
1 CPX-AB-4-M12x2-5POL CPX-AB-4-M12x2-5POL-R	Socket, M12, 5-pin	2 SEA-GS-7	Screw terminals	–	–
		2 SEA-4GS-7-2,5	Screw terminals	–	–
		2 SEA-GS-9	Screw terminals	–	–
		2 SEA-M12-5GS-PG7	Screw terminals	–	–
		2 SEA-GS-11-DUO	Screw terminals, for two cables	–	–
		2 SEA-5GS-11-DUO	Screw terminals, for two cables	–	–
		3 NEBU-...-M12G5	Socket, M8, 4-pin	–	–
			Socket, M12, 5-pin	–	–
			Open cable end	–	–
		4 NEDY-... (modular system for choice of sensor/actuator distributors)	2x socket, M8, 3-pin	–	–
			2x socket, M8, 4-pin	–	–
			2x socket, M12, 5-pin	–	–
			2x socket, type A	–	–
			2x socket, type B	–	–
			2x socket, type C	–	–
			2x socket, connection pattern H	–	–
			2x socket, connection pattern ZB	–	–
			2x socket, connection pattern ZC	–	–
		2x open cable end	–	–	
		5 NEDY-L2R1-V1-M8G3-N-M12G4 (T-adapter)	Plug M12, 4-pin to 2x socket M8, 3-pin	6 SEA-GS-M8	Solder lugs
				6 SEA-3GS-M8-S	Screw terminals
		5 NEDY-L2R1-V1-M12G5-N-M12G4 (T-adapter)	Plug M12, 4-pin to 2x socket M12, 5-pin	7 NEBU-...-M8G3 (modular system for choice of connecting cables)	Socket, M8, 3-pin
					Socket, M8, 4-pin
					Socket, M12, 5-pin
					Open cable end
				6 SEA-GS-7	Screw terminals
				6 SEA-4GS-7-2,5	Screw terminals
				6 SEA-GS-9	Screw terminals
				6 SEA-M12-5GS-PG7	Screw terminals
				6 SEA-GS-11-DUO	Screw terminals, for two cables
6 SEA-5GS-11-DUO	Screw terminals, for two cables				
7 NEBU-...-M12G5 (modular system for choice of connecting cables)	Socket, M8, 4-pin				
	Socket, M12, 5-pin				
	Open cable end				

Terminal CPX

Key features – Electrical components

Electrical connection – Connection block (metal design)

CPX-M-AB-4-M12X2-5POL and CPX-M-AB-4-M12X2-5POL-T with M12-5POL connection

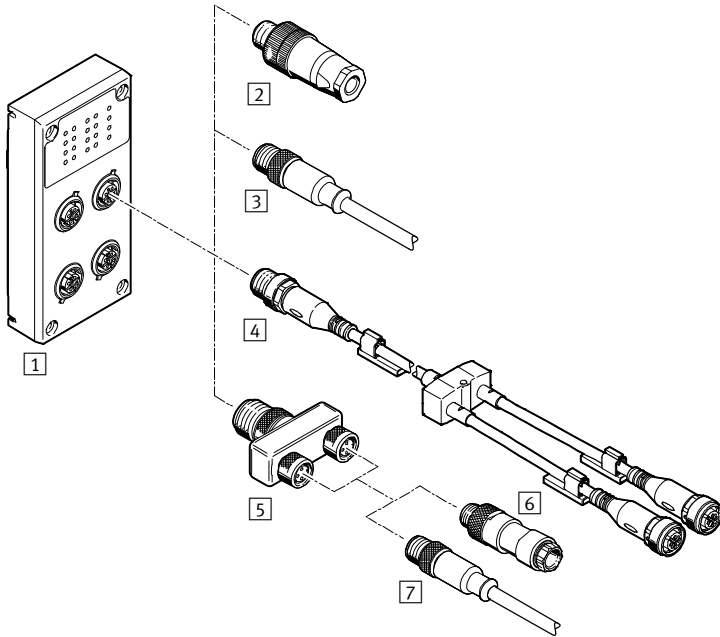

- Suitable for self-assembly and sturdy with 2 channels per connection
- 4 sockets
- 5-pin design per socket
- With two channels per connection, the corresponding input signals can be easily connected via a T-adapter and conventional connecting cables with M8 connection

CPX-M-AB-8-M12X2-5POL and CPX-AB-8-M12X2-5POL with M12-5POL connection

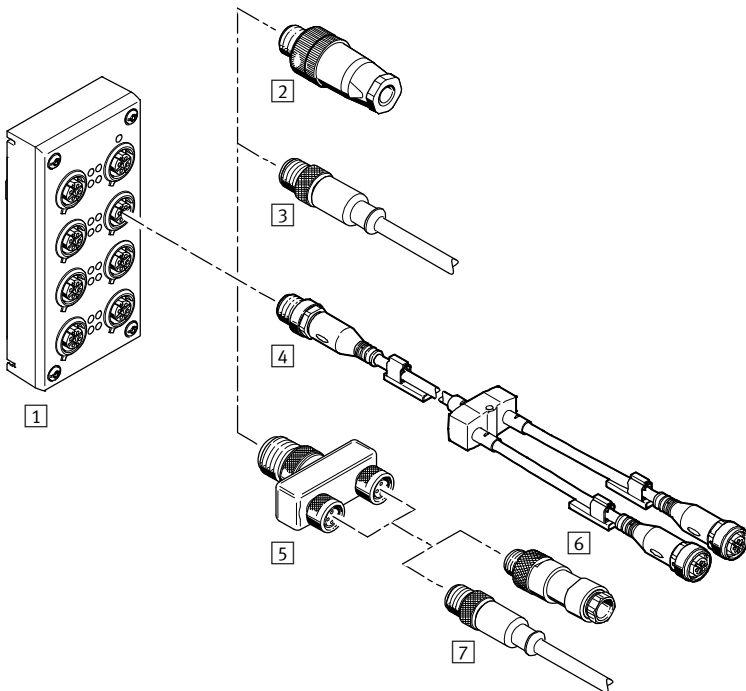

- Suitable for self-assembly and sturdy with 2 channels per connection
- 8 sockets
- 5-pin design per socket
- With two channels per connection, the corresponding input signals can be easily connected via a T-adapter and conventional connecting cables with M8 connection

-  - Note

Max. 4 T-adapters (NEDY) can be mounted on a connection block.

Terminal CPX

Key features – Electrical components

Combination of connection block and electrical connection technology					
Connection block	Connection technology	Plug connector/ connecting cable	Connection technology	Plug connector/ connecting cable	Connection technology
1 CPX-M-AB-4-M12X2-5POL CPX-M-AB-8-M12X2-5POL CPX-AB-8-M12X2-5POL	Socket, M12, 5-pin	2 SEA-GS-7	Screw terminals	–	–
		2 SEA-4GS-7-2,5	Screw terminals	–	–
		2 SEA-GS-9	Screw terminals	–	–
		2 SEA-M12-5GS-PG7	Screw terminals	–	–
		2 SEA-GS-11-DUO	Screw terminals, for two cables	–	–
		2 SEA-5GS-11-DUO	Screw terminals, for two cables	–	–
		3 NEBU-...-M12G5	Socket, M8, 4-pin	–	–
			Socket, M12, 5-pin	–	–
			Open cable end	–	–
		4 NEDY-... (modular system for choice of sensor/actuator distributors)	2x socket, M8, 3-pin	–	–
			2x socket, M8, 4-pin	–	–
			2x socket, M12, 5-pin	–	–
			2x socket, type A	–	–
			2x socket, type B	–	–
			2x socket, type C	–	–
			2x socket, connection pattern H	–	–
			2x socket, connection pattern ZB	–	–
			2x socket, connection pattern ZC	–	–
		2x open cable end	–	–	
		5 NEDY-L2R1-V1-M8G3-N-M12G4 (T-adapter)	Plug M12, 4-pin to 2x socket M8, 3-pin	6 SEA-GS-M8	Solder lugs
				6 SEA-3GS-M8-S	Screw terminals
		5 NEDY-L2R1-V1-M12G5-N-M12G4 (T-adapter)	Plug M12, 4-pin to 2x socket M12, 5-pin	7 NEBU-...-M8G3 (modular system for choice of connecting cables)	Socket, M8, 3-pin
					Socket, M8, 4-pin
					Socket, M12, 5-pin
					Open cable end
				6 SEA-GS-7	Screw terminals
				6 SEA-4GS-7-2,5	Screw terminals
				6 SEA-GS-9	Screw terminals
				6 SEA-M12-5GS-PG7	Screw terminals
				6 SEA-GS-11-DUO	Screw terminals, for two cables
6 SEA-5GS-11-DUO	Screw terminals, for two cables				
7 NEBU-...-M12G5 (modular system for choice of connecting cables)	Socket, M8, 4-pin				
	Socket, M12, 5-pin				
	Open cable end				

Terminal CPX

Key features – Electrical components

Electrical connection – Connection block with connection, M12, 4-pin

CPX-P-AB-4XM12-4POL

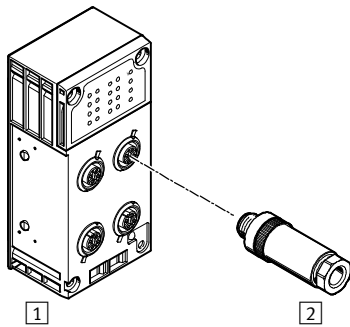

- Suitable for self-assembly and sturdy
- 4 sockets
- 4-pin design per socket

Combination of connection block and electrical connection technology

Connection block	Connection technology	Plug connector/connecting cable	Selectable connection technology
1 CPX-P-AB-4XM12-4POL	Socket, M12, 4-pin	2 SEA-GS-HAR-4POL	Insulation displacement connectors
		2 SEA-4GS-7-2,5	Screw terminal
		2 SEA-GS-7	Screw terminal
		2 SEA-GS-9	Screw terminal

Electrical connection – Connection block with clamping connector

CPX-P-AB-2XKL-8POL

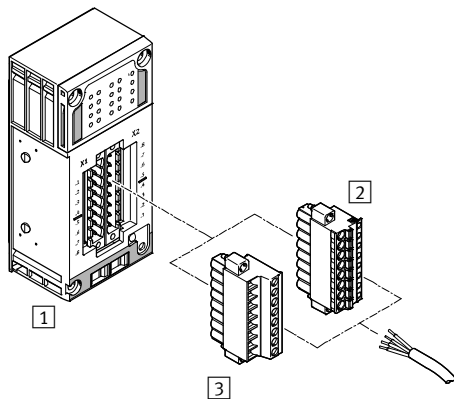

- Quick connection technology for use in control cabinets
- Spring-loaded terminals or screw terminals
- Wire cross sections 0.2 ... 2.5 mm²

Combination of connection block and electrical connection technology

Connection block	Connection technology	Plug connector/connecting cable	Selectable connection technology
1 CPX-P-AB-2XKL-8POL	Plug, 8-pin	2 NECU-L3G8-C1	Spring-loaded terminals
		3 NECU-L3G8-C2	Screw terminals

Terminal CPX

Key features – Electrical components

Electrical connection – Connection block

CPX-AB-4-M12-8POL with M12-8POL connection

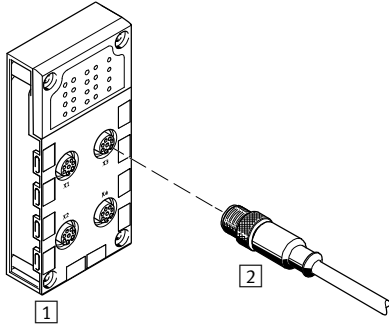

- Connection to cylinder/valve combinations with max. 3 inputs and 2 outputs
- 4 sockets
- 8-pin design per socket

Combination of connection block and electrical connection technology

Connection block	Connection technology	Plug connector/connecting cable	Selectable connection technology
1 CPX-AB-4-M12-8POL	Socket, M12, 8-pin	2 KM12-8GD8GS-2-PU (pre-assembled connecting cable)	Socket, M12, 8-pin

CPX-AB-8-KL-4POL, CPX-2ZE2DA with spring-loaded terminal connection

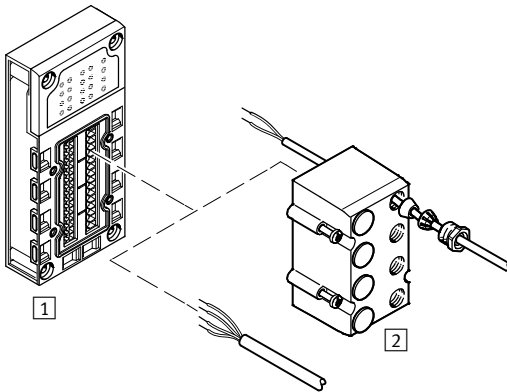

- Quick connection technology for use in control cabinets
- 32 spring-loaded terminals
- 4 spring-loaded terminals per channel
- Wire cross sections 0.05 ... 1.5 mm²
- Optional cover with fittings for IP65, IP67 connection
 - 8 through-holes M9
 - 1 through-hole M16
 - Blanking plug
 - For I/O distributors, consoles or individual sensors/actuators

Combination of connection block and electrical connection technology

Connection block	Connection technology	Plug connector/connecting cable	Selectable connection technology
1 CPX-AB-8-KL-4POL CPX-2ZE2DA	Spring-loaded terminals, 32-pin	2 AK-8KL (cover)	–

Terminal CPX

Key features – Electrical components

Electrical connection – Connection block

CPX-AB-1-SUB-BU-25POL with Sub-D connection

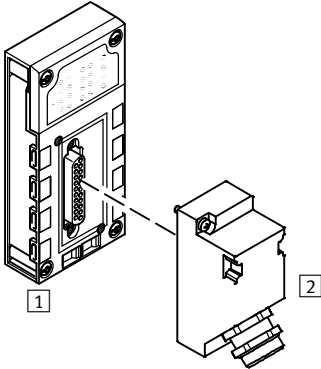

- Multi-pin plug connection for I/O distributor or console
- One socket
- 25-pin design

Combination of connection block and electrical connection technology

Connection block	Connection technology	Plug connector/connecting cable	Selectable connection technology
1 CPX-AB-1-SUB-BU-25POL	Socket, Sub-D, 25-pin	2 SD-SUB-D-ST25	Crimp contacts

CPX-AB-4-HAR-4POL with quick connection

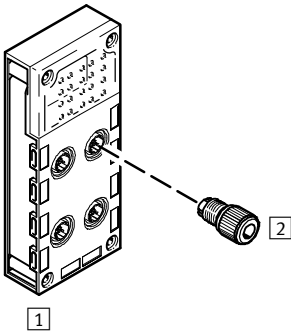

- Sturdy quick connection technology for individual connections
- 4 sockets
- 4-pin design per socket

Combination of connection block and electrical connection technology

Connection block	Connection technology	Plug connector/connecting cable	Selectable connection technology
1 CPX-AB-4-HAR-4POL	Socket, quick connection, 4-pin	2 SEA-GS-HAR-4POL	Insulation displacement connectors

Terminal CPX

Key features – Assembly

Hood

Description

→ page 244

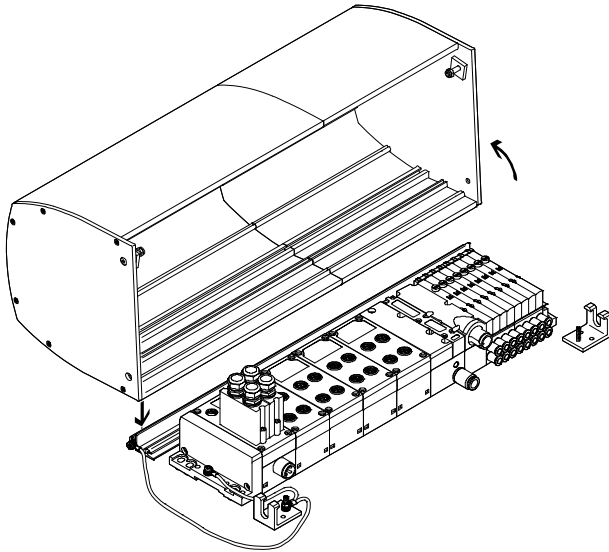

The CPX hood CAFC is a space- and cost-saving alternative to a control cabinet.

It is designed as an extruded aluminium profile and is installed on a mounting plate.

The valve terminal (CPX with MPA-S or MPA-L) is well protected and is quick to install without the need for complex control cabinet installation for connecting cables and tubing.

The rail and the two mounting brackets are mounted on a base plate. The hood is attached to the retaining rail and secured with two screws. There is also a stand-by position (locking of the hood in the open position).

The hood is locked using two side screws (which meet the requirements for a special lock in compliance with ATEX).

The CPX hood can be ordered online using the valve terminal configurator.

Advantages of the CPX hood

- Impact protection (min. 7 J) for the underlying modules in combination with a suitable mounting plate provided by the user
- Protection against electrostatic discharge through the use of electrically conductive materials and the option of connecting an earth wire
- Protection against disconnection of live plug connectors (by securing the hood with at least one special lock to EN 600079-0, 9.2 and 20)
- UV protection for the underlying CPX and MPA modules

Points to note when using the CPX hood

- Only in combination with valve terminal MPA-S and MPA-L
- No bus nodes with push-pull connection (CPX-M-FB34, CPX-M-FB35, CPX-M-FB41)
- CPX power supply via angled plugs, no T-plugs, no push-pull
- Electrical supply plate/additional power supply only possible with angled plug
- No MPA vertical stacking
- Use of larger fittings (for tubing O.D. larger than 12 mm) only possible with the angled design
- Ducted exhaust air only with elbow connector
- The permissible ambient temperature of the valve terminal is reduced by 5 °C

Note

The CPX hood has no influence on the ATEX classification of the valve terminal or of the CPX terminal.

The CPX hood has no influence on the IP protection class of the valve terminal or of the CPX terminal.

The CPX hood does not protect against the effects of the weather in installations that are not in closed spaces.

Terminal CPX

Key features – Assembly

FESTO

Hood

Mounting

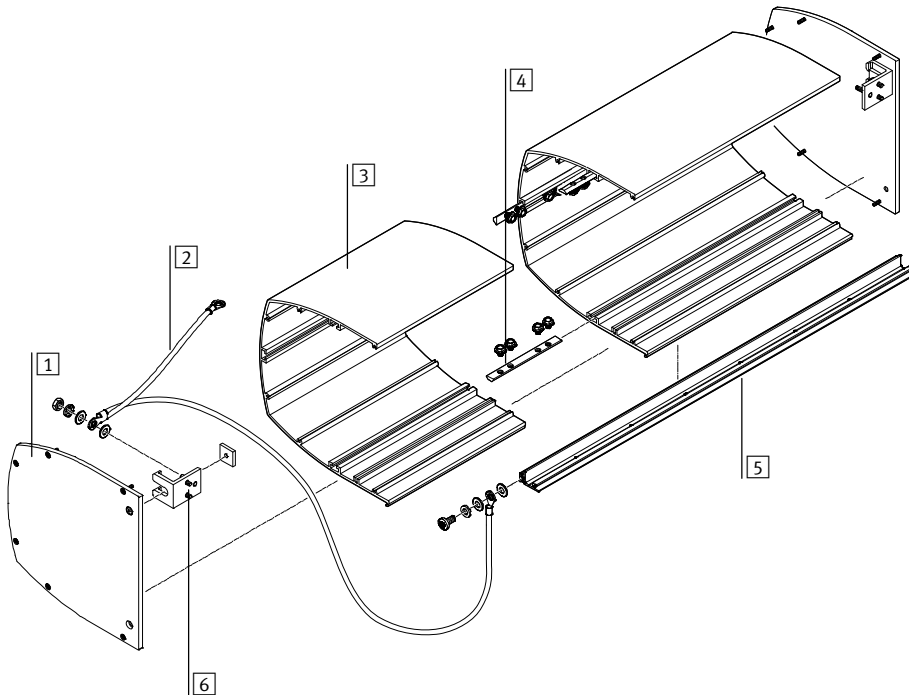

Procedure:

- Assemble the rail and mounting bracket included in the mounting kit
- Attach the earth cable
- Assemble the hood (if applicable, screw together several hood sections before attaching the side pieces)
- Attach and secure the hood

- 1 Side piece
- 2 Earth cable
- 3 Hood section
- 4 Slot nut with screws, for joining the hood sections
- 5 Rail
- 6 Mounting bracket

Technical data

Weight:

- Hood: approx. 500 g per 100 mm of length
- Mounting rail: approx. 550 g per 1000 mm of length
- Side pieces: approx. 500 g per side

- Ambient temperature $-5 \dots +50 \text{ }^\circ\text{C}$
- RoHS-compliant

Plug coding

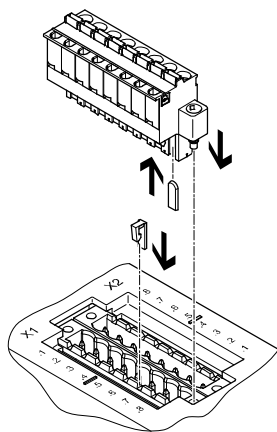

The connection blocks CPX-P-AB-2XKL-8POL and the sockets NECU-L3G8 can be matched to one another using the coding elements CPX-P-KDS-AB-2XKL.

This reduces the likelihood of a socket being inserted in the wrong slot after it is removed from the CPX terminal (protection against incorrect insertion).

Terminal CPX

Key features – Assembly

Extension

Functional principle

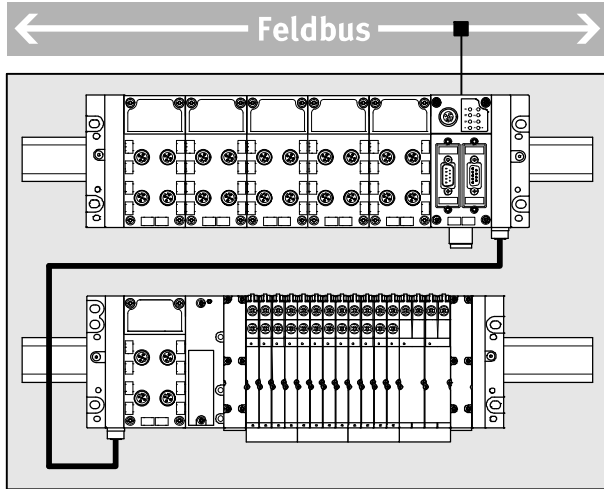

The extension enables the CPX terminal to be separated into or configured as two interconnected units (series). The two parts are controlled by a common bus node or control block. An extensive CPX terminal can fit into limited installation spaces more easily in the form of two compact units.

- Applications:
- Installation in a control cabinet on two levels, one beneath the other
 - Installation in two separate control cabinets
 - Installation of part of the CPX terminal inside and part outside the control cabinet
 - Spatial separation of electrics and pneumatics

Performance limits

- A maximum of 10 CPX modules are permitted on the first row
 - A maximum of 8 CPX modules and a pneumatic interface are permitted in the second row
- The number of CPX modules and solenoid coils is additionally limited by:
- the address space made available by the control block/bus node
 - their address requirement
 - their current consumption

Optimisation

- The maximum possible performance or maximum number of modules can only be achieved if the following conditions are observed:
- The control block/bus node is installed in the first row, on the far right, on an interlinking block with system supply
 - The connecting cable between the first and second row is max. 2 m long
 - An interlinking block with additional power supply for valves is situated in the second row

Configuration rules

- The extension limits the power supply for the sensors and electronics for the CPX terminal as a whole as follows:
- first row max. 6 A
 - second row max. 2 A
 - first and second row together, max. 6 A
- If the 3 m connecting cable is used, the following restrictions are in place:
- There can only be one CPX module in the second row
 - An additional power supply for valves is required in order to connect a valve terminal
- Positioning output modules in the second row requires a corresponding power supply in the second row:
- Install interlinking block with additional power supply for outputs in the second row to the left of the first output module

Terminal CPX

Key features – Assembly

FESTO

Extension – Permissible CPX modules			
	Type	First row	Second row
Control blocks	CPX-CEC	Permissible, at least one control block or bus node required	Not permissible
Bus node	CPX-FB CPX-M-FB	Permissible, at least one control block or bus node required	Not permissible
Technology modules	CPX-CP CPX-CTEL CPX-CTEL-2 CPX-CM-HPP CPX-CMAX CPX-CMPX CPX-CMIX	Permissible	Not permissible
Input/output modules	CPX	Permissible	Permissible
PROFIsafe shut-off module	CPX-FVDA-P2	Not permissible	Not permissible
Interlinking block/end plate with system supply	CPX-EPL-EV-S CPX-GE-EV-S CPX-M-GE-EV-S	Permissible, at least one interlinking block/end plate with system supply required	Not permissible
Interlinking block with additional power supply	CPX-GE-EV-Z CPX-M-GE-EV-Z CPX-GE-EV-V	Permissible	Permissible
Interlinking block without supply	CPX-GE-EV CPX-M-GE-EV	Permissible	Permissible
Pneumatics interface	VMPA-FB	Not permissible	Permissible
	VMPAL-EPL-CPX	Not permissible	Permissible
	VABA-S6-1	Not permissible	Permissible

Terminal CPX

Key features – Assembly

Extension – Maximum number of CPX modules/solenoid coils		
Special features of the design	First row	Second row
CPX terminal with valve terminal		
Connecting cable 3 m	10 CPX modules	Valve terminal MPA-S with: <ul style="list-style-type: none"> • Pneumatic interface for CPX metal interlinking module • Electrical air supply plate VMPA-FB-SP directly after the pneumatic interface • Electronics modules with galvanic isolation • 128 solenoid coils (64 valve positions)
		Valve terminal VTSA/VTSA-F with: <ul style="list-style-type: none"> • 1 CPX module with interlinking block with additional power supply for valves • 32 solenoid coils (32 valve positions)
CPX terminal without valve terminal		
• Control block/bus node not in position on the far right of the first row	10 CPX modules	• 2 ... 5 CPX modules, depending on the control block/bus node used
• Control block/bus node in position on the far right of the first row	10 CPX modules	• 4 ... 8 CPX modules, depending on the control block/bus node used
CPX terminal with valve terminal MPA-S		
–	10 CPX modules	• 2 ... 5 CPX modules and manifold blocks MPA-S, depending on the control block/bus node used
• Electrical air supply plates VMPA-FB-SP • Electronics modules with galvanic isolation	10 CPX modules	• 2 ... 5 CPX modules, depending on the control block/bus node used • Up to 128 solenoid coils (64 valve positions)
• Control block/bus node in position on the far right of the first row • CPX-FB11 or CPX-CEC not possible	10 CPX modules	• 4 ... 5 CPX modules and manifold blocks MPA-S, depending on the control block/bus node used
• CPX-FB13 or CPX-FB36 • Control block/bus node in position on the far right of the first row • Interlinking block with system supply in position on the far right of the first row	10 CPX modules	• 8 CPX modules and manifold blocks MPA-S
• CPX-FB13 or CPX-FB36 • Control block/bus node in position on the far right of the first row • Interlinking block with additional power supply for valves in position on the far right of the first row	10 CPX modules	• 8 CPX modules and manifold blocks MPA-S
• CPX-FB13 or CPX-FB36 • Control block/bus node in position on the far right of the first row • Interlinking block with additional power supply for valves in second row	10 CPX modules	• 8 CPX modules and manifold blocks MPA-S

Terminal CPX

Key features – Assembly

FESTO

Extension – Maximum number of CPX modules/solenoid coils		
Special features of the design	First row	Second row
CPX terminal with valve terminal MPA-L		
–	10 CPX modules	<ul style="list-style-type: none"> • 2 CPX modules (at least one CPX module required) • 16 solenoid coils (valve widths 10 mm and 14 mm) or 8 solenoid coils (valve width 20 mm)
• Interlinking block with additional power supply for valves in second row	10 CPX modules	<ul style="list-style-type: none"> • 2 CPX modules (at least one CPX module required) • 32 solenoid coils (32 valve positions)
CPX terminal with valve terminal VTSA/VTSA-F		
–	10 CPX modules	<ul style="list-style-type: none"> • 2 CPX modules • 12 solenoid coils (valve widths 18 mm and 26 mm and 42 mm) or 6 solenoid coils (valve widths 52 mm and 65 mm)
• Interlinking block with additional power supply for valves in second row	10 CPX modules	<ul style="list-style-type: none"> • 2 CPX modules • 32 solenoid coils (32 valve positions)

Terminal CPX

Key features – Assembly

Mounting options

Valve terminals with CPX terminal support different mounting options for direct machine mounting a high

degree of high protection and control cabinet installation.

H-rail mounting

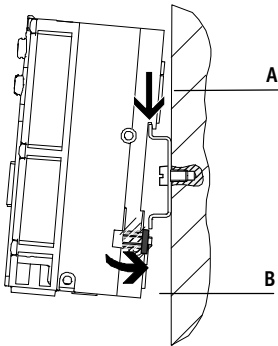

The H-rail mounting is part of the reverse profile of the CPX interlinking blocks. The CPX terminal can be attached to the H-rail using the H-rail mounting kit.

The CPX terminal is mounted on the H-rail for this purpose (see arrow A).

It is then swivelled onto the H-rail and secured in place with the clamping component (see arrow B).

The optional earthing plate enables a connection to be established to the machine potential/earth in one easy step.

For H-rail mounting you will need the following mounting kit:

- CPX-CPA-BG-NRH

This facilitates mounting of the CPX terminal on H-rails to EN 60715.

An additional mounting kit is required for combination with valve terminals.

Wall mounting, plastic design

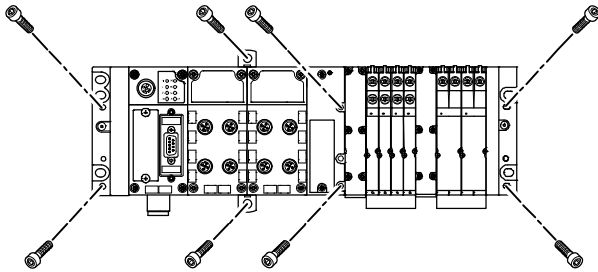

The end plates of the CPX terminal, the valve terminal and the pneumatic interface include mounting holes for wall mounting. Additional mountings for the CPX terminal are available for longer valve terminals. These mountings differ depending on the design of the CPX terminal (plastic or metal).

Wall mounting, metal design

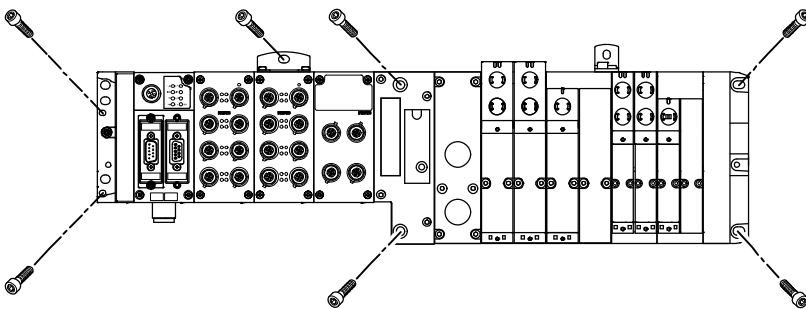

Terminal CPX

Key features – Assembly

Plastic design CPX terminal

Additional mountings

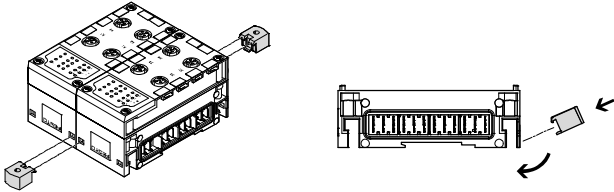

For longer valve terminals, there are additional mounting components for the CPX terminal that can be fitted between two modules.



Note

In the case of CPX terminals with 4 and more interlinking blocks, additional mountings of the type CPX-BG-RW must be used every 100 or 150 mm. These are supplied pre-assembled.

Interlinking with tie rods

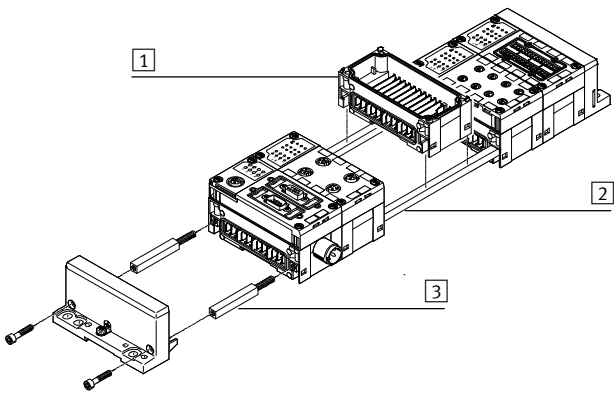

The CPX modules are mechanically connected using special tie rods **2**. Two screws in the end plates are all that are needed to assemble the entire unit. The tie rod ensures that the unit resists high mechanical loads and is therefore the mechanical backbone of the CPX terminal.

The open design enables interlinking blocks **1** to be replaced in the assembled state.

The tie rod expansion kit **3** enables an extra module to be added to the CPX terminal.

CPX terminal in metal design

Additional mountings

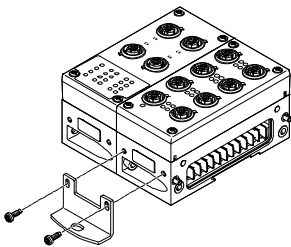

For longer valve terminals, there are additional mounting brackets for the CPX terminal that can be screwed onto the interlinking blocks. The mounting bracket CPX-M-BG-VT-2X enables a CPX terminal with valve terminal VTSA/VTSA-F to be mounted on a support system.



Note

In the case of CPX terminals with 4 and more interlinking blocks, additional mounting brackets of the type CPX-M-BG-RW must be used every 100 or 150 mm. These are supplied pre-assembled.

Linking with screws

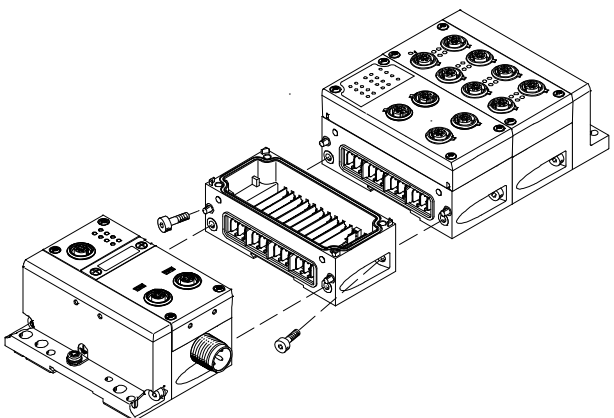

The CPX modules are mechanically connected using a special angled fitting. The CPX terminal can thus be expanded at any time.

Terminal CPX

Key features – Power supply

Power supply concept

General

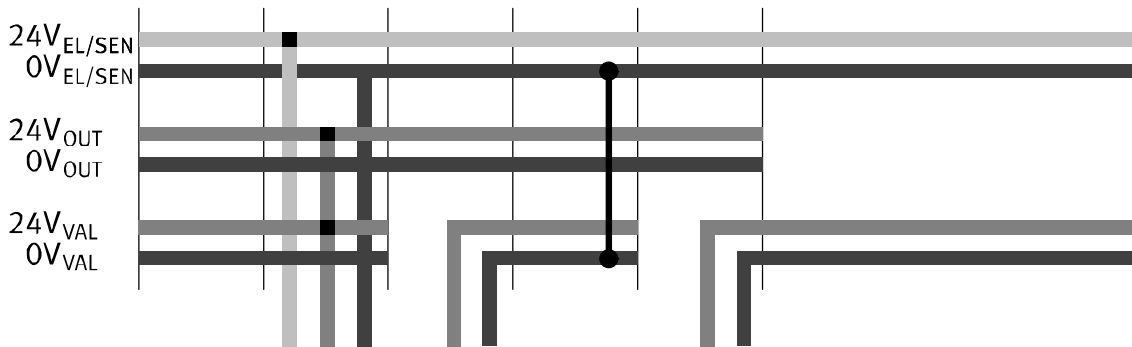
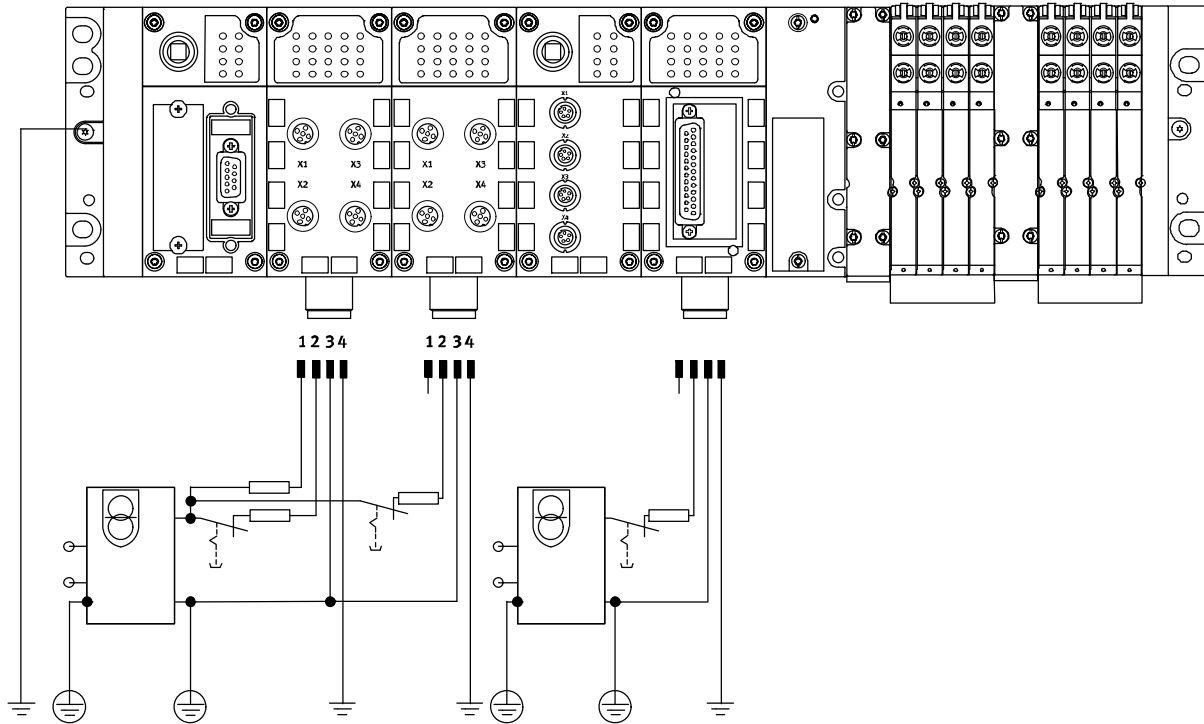

The use of decentralised devices on the fieldbus – particularly with a high degree protection for direct machine mounting – demands a flexible power

supply concept. A valve terminal with CPX can, in principle, supply all voltages via a single connection. A distinction is made between the

supply for

- Electronics plus sensors
- Valves plus actuators

in this case.

Selectable connection technology:

- M18
- 7/8"
- AIDA push-pull

Interlinking blocks

Interlinking blocks represent the backbone of the CPX terminal with all supply lines. They provide the power supply for the modules used on them

as well as their bus connections. Many applications require the CPX terminal to be segmented into voltage zones. This applies in particular to the

separate disconnection of solenoid coils and outputs. The interlinking blocks provide either a space-saving central power supply

for the entire CPX terminal or galvanically isolated, all-pin disconnectable potential groups/voltage segments.

Terminal CPX

Key features – Power supply

Interlinking blocks

With system supply

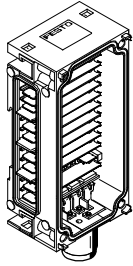

Type for plastic design

- CPX-GE-EV-S
- CPX-GE-EV-S-7/8-4POL
- CPX-GE-EV-S-7/8-5POL

Connection technology

- M18 4-pin
- 7/8" 4-pin
- 7/8" 5-pin

Power supply

- For CPX terminal modules and connected sensors
- For valves that are connected to the CPX terminal via a pneumatic interface
- For actuators that are connected to the output modules of the CPX terminal

Type for metal design

- CPX-M-GE-EV-S-7/8-CIP-4P
- CPX-M-GE-EV-S-7/8-5POL
- CPX-M-GE-EV-S-PP-5POL

Connection technology

- 7/8" 4-pin
- 7/8" 5-pin
- AIDA push-pull, 5-pin

Without power supply

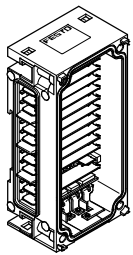

Type for plastic design

- CPX-GE-EV

–

–

Type for metal design

- CPX-M-GE-EV
- CPX-M-GE-EV-FVO

–

With additional power supply for outputs

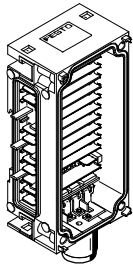

Type for plastic design

- CPX-GE-EV-Z
- CPX-GE-EV-Z-7/8-4POL
- CPX-GE-EV-Z-7/8-5POL

Connection technology

- M18 4-pin
- 7/8" 4-pin
- 7/8" 5-pin

Power supply

- For actuators that are connected to the output modules of the CPX terminal

Type for metal design

- CPX-M-GE-EV-Z-7/8-5POL
- CPX-M-GE-EV-Z-PP-5POL

Connection technology

- 7/8" 5-pin
- AIDA push-pull, 5-pin

With additional power supply for valves

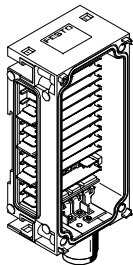

Type for plastic design

- CPX-GE-EV-V
- CPX-GE-EV-V-7/8-4POL

Connection technology

- M18 4-pin
- 7/8" 4-pin

Power supply

- For valves that are connected to the CPX terminal via a pneumatic interface

-  - Note

For 7/8":
– Commercially available accessories are often limited to max. 8 A

-  - Note

Valve terminal MPA-S has either a 7/8" 5-pin, 7/8" 4-pin, 3-pin M18 or 5-pin AIDA push-pull power supply for one or more valve voltage zones. Galvanically isolated, all pins disconnectable with voltage monitoring in the following MPA module.

-  - Note

Suitable versions of the interlinking blocks with M18 and 7/8", 5-pin connection are available (CPX-GE-EV-...-VL and CPX-M-GE-EV-...-VL) for use in ATEX environments as per certification (➔ page 47). The maximum current supply for these interlinking blocks is 8 A.

Terminal CPX

Key features – Diagnostics

Diagnostics

System performance

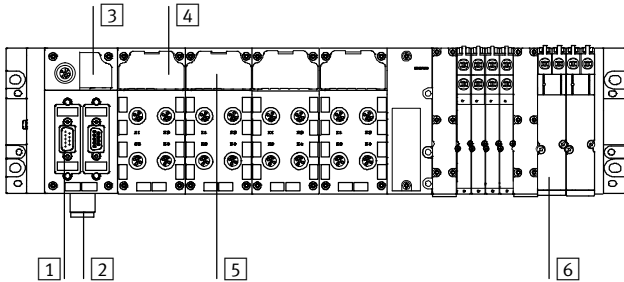

- 1 Diagnostics via bus interface
- 2 Undervoltage monitoring
- 3 Diagnostic overview LED
 - Fieldbus status
 - CPX status
- 4 Status and diagnostic LED for module and I/O channels
- 5 Module and channel-specific diagnosis
- 6 Valve-specific diagnostics for module and solenoid coils
- 7 MPA pressure sensor – integrated solution on the fieldbus
 - Pre-assembled for ducts 1, 3, 5 and external pressures

Detailed diagnostic functions are needed in order to quickly locate the causes of errors in the electrical installation and therefore reduce downtimes in production plants. A basic distinction is made between on-the-spot diagnostics using LEDs or an operator unit and diagnostics using a bus interface.

The CPX terminal supports on-the-spot diagnostics via a row of LEDs. This is separate from the connection area and therefore provides good visual access to status and diagnostic information.

Module and channel-specific diagnosis is supported, for example

- Undervoltage detection for outputs and valves
- Short circuit detection for sensors, outputs and valves
- Open-load detection for a missing solenoid coil
- Storage of the last 40 causes of errors with error start and error end

The diagnostic messages can be read out via the bus interface in the higher-order controller and visualised for the central recording and evaluation of error causes. This is done using the individual fieldbus-specific channels. The CPX-CEC also offer the option of access via the integrated Ethernet interface (remote maintenance via PC/web applications).

Overview of LEDs on the bus node

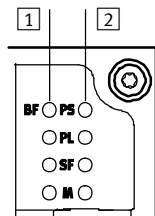

- 1 Fieldbus-specific LEDs
 - On each bus node, a maximum of 4 fieldbus-specific LEDs display the fieldbus communication status of the CPX terminal with the higher-order controller.
- 2 CPX-specific LEDs
 - A further 4 CPX-specific LEDs provide non-fieldbus-specific information about the status of the CPX terminal, for example
 - Power system
 - Power load
 - System fault
 - Modification parameters

Input/output module status and diagnostic LEDs

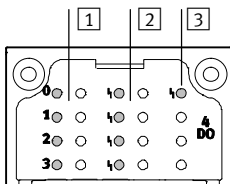

- 1 Status LEDs for the inputs and outputs
 - Each input and output channel is assigned a status LED.
- 2 Channel-oriented diagnostic LEDs
 - Depending on the module design, another diagnostic LED is available for each I/O channel
- 3 Group diagnostic LEDs
 - An LED displays the group diagnostics for each module

Terminal CPX

Key features – Parameterisation

Diagnostics

Display on the operator unit

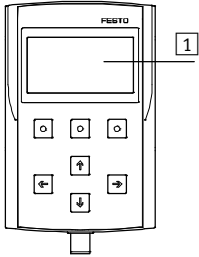

- 1 LCD graphical display for on-site plain-text diagnostics
 - Fault location and type
 - Without programming

Display on a PC

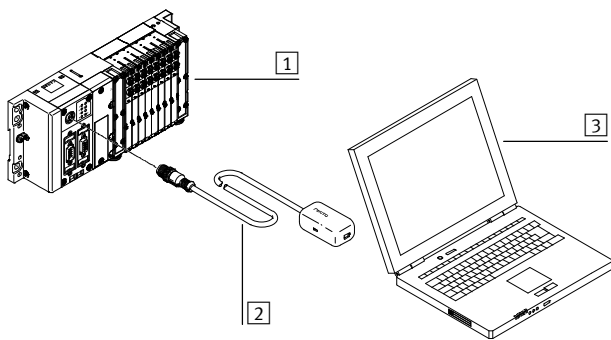

- 1 CPX terminal with valve terminal
 - Fault location and type
 - Without programming
- 2 Adapter diagnostic interface to USB
 - Storing the configuration
 - Preparing screenshots
- 3 Laptop/portable device with USB interface and installed FMT software

Parameterisation

Changes to the application are often required during commissioning. The parameterisable characteristics of the CPX modules mean that functions can be very easily changed by means of configuration software. This reduces

the number of modules needed and, consequently, the amount of storage space required.

It is therefore possible, for example, to reduce the switch-on debounce time for an input module – normally 3 ms –

to 0.1 ms on a "fast" input module for faster processes, or to set the response of a valve following a fieldbus interrupt.

Depending on the modules used, parameterisation can be performed

via the following interfaces:

- Ethernet
- Fieldbus
- Control block direct interface (programming interface)
- Operator unit CPX-MMI

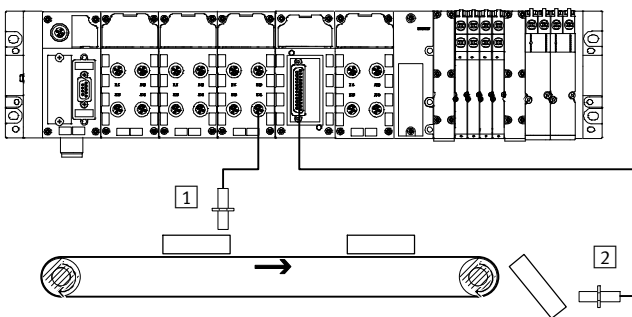

- 1 Input debounce time 3 ms
- 2 Input debounce time 0.1 ms

Terminal CPX

Key features – Addressing

Addressing

The various CPX modules occupy a different number of I/O addresses within the CPX system. The maximum address space for bus nodes depends on the performance of the fieldbus systems.

Maximum system configuration:

- 1 bus node or control block
- 9 I/O modules
- 1 pneumatic interface (e.g. pneumatic interface MPA-S with up to 16 MPA manifold blocks)

The maximum system configuration can be limited in individual cases by exceeding the address space.



Note

Please refer to the detailed description of the configuration/addressing rules in the technical data for CPX bus nodes.

Overview – Address space for CPX bus node and control block

	Protocol	Max. total		Max. digital		Max. analogue	
		Inputs	Outputs	Inputs	Outputs	Inputs	Outputs
CPX-CEC	<ul style="list-style-type: none"> • CoDeSys level 2 • TCP/IP • Easy IP • Modbus TCP 	512 bits	512 bits	512 DI	512 DO	32 AI	18 AO
CPX-FB6	INTERBUS	96 bits	96 bits	96 DI	96 DO	6 AI	6 AO
CPX-FB11	DeviceNet	512 bits	512 bits	512 DI	512 DO	32 AI	18 AO
CPX-FB13	PROFIBUS	512 bits	512 bits	512 DI	512 DO	32 AI	18 AO
CPX-FB14	CANOpen	256 bits	256 bits	64 DI (+ 64 DI)	64 DO (+ 64 DO)	8 AI (+ 8 AI)	8 AO (+ 8 AO)
CPX-M-FB21	INTERBUS (LWL)	96 bits	96 bits	96 DI	96 DO	6 AI	6 AO
CPX-FB23-24	CC-Link	512 bits	512 bits	512 DI	512 DO	32 AI	18 AO
CPX-FB33	PROFINET RT	512 bits	512 bits	512 DI	512 DO	32 AI	18 AO
CPX-M-FB34	PROFINET RT	512 bits	512 bits	512 DI	512 DO	32 AI	18 AO
CPX-M-FB35	PROFINET RT	512 bits	512 bits	512 DI	512 DO	32 AI	18 AO
CPX-FB36	EtherNet/IP	512 bits	512 bits	512 DI	512 DO	32 AI	18 AO
CPX-FB37	EtherCAT	512 bit	512 bit	512 DE	512 DA	32 AE	18 AA
CPX-FB38	EtherCAT	512 bits	512 bits	512 DI	512 DO	32 AI	18 AO
CPX-FB39	Sercos III	512 bit	512 bit	512 DE	512 DA	32 AE	18 AA
CPX-FB40	POWERLINK	512 bit	512 bit	512 DE	512 DA	32 AE	18 AA
CPX-M-FB41	PROFINET RT	512 bit	512 bit	512 DE	512 DA	32 AE	18 AA

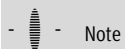

Note

The bandwidth of the bus nodes can be restricted by the choice of module and the maximum number of modules.

Example CPX-FB6 (INTERBUS)

	Digital inputs	Digital outputs	Notes
3x CPX-8DE	24	–	<ul style="list-style-type: none"> • The address space is occupied by 7 CPX I/O modules plus pneumatic interface • No additional modules can be configured
1x CPX-8DE-8DA	8	8	
2x CPX-2AE	64	–	
1x CPX-2AA	–	32	
3x VMPA1	–	24	
Allocated address space	96	96	

DI = Digital inputs (1 bit)

DO = Digital outputs (1 bit)

AO = Analogue outputs (16 bits)

AI = Analogue inputs (16 bits)

Terminal CPX

Key features – Addressing

Overview – Allocated addresses for CPX modules		
	Inputs [bit]	Outputs [bit]
CPX-CP-4-FB	16, 32, 48, 64, 80, 96, 128 ¹⁾	16, 32, 48, 64, 80, 96, 128 ¹⁾
CPX-CTEL-4-M12-5POL	0, 64, 128, 192, 256 ¹⁾	0, 64, 128, 192, 256 ¹⁾
CPX-CTEL-2-M12-5POL-LK	64, 128, 192, 256 ¹⁾	64, 128, 192, 256 ¹⁾
CPX-CM-HPP	256	256
CPX-CMAX-C1-1	64	64
CPX-CMPX-C-1-H1	48	48
CPX-CMIX-M1-1	48	48
CPX-4DE	4	–
CPX-8DE	8	–
CPX-8DE-D	8	–
CPX-8NDE	8	–
CPX-F8DE-P	48	56
CPX-16DE	16	–
CPX-M-16DE-D	16	–
CPX-L-16DE-16-KL-3POL	16	–
CPX-4DA	–	4
CPX-8DA	–	8
CPX-8DA-H	–	8
CPX-8DE-8DA	8	8
CPX-L-8DE-8DA-16-KL-3POL	8	8
CPX-2ZE2DA	96	96
CPX-4AE-4AA-H 	0, 16, 32, 48, 64, 128, 144, 160, 176, 192 ¹⁾	0, 16, 32, 48, 64 ¹⁾
CPX-2AE-U-I	2 x 16	–
CPX-4AE-U-I	4 x 16	–
CPX-4AE-I	4 x 16	–
CPX-4AE-P-B2	4 x 16	–
CPX-4AE-P-D10	4 x 16	–
CPX-4AE-T	4 x 16	–
CPX-4AE-TC	4 x 16	–
CPX-2AA-U-I	–	2 x 16
CPX-FVDA-P2	48	48
VMPA1-FB-EMS-8	–	8
VMPA1-FB-EMG-8	–	8
VMPA2-FB-EMS-4	–	4
VMPA2-FB-EMG-4	–	4
VMPA1-FB-EMS-D2-8	–	8
VMPA1-FB-EMG-D2-8	–	8
VMPA2-FB-EMS-D2-4	–	4
VMPA2-FB-EMG-D2-4	–	4
VMPA-FB-PS-1	16	–
VMPA-FB-PS-3/5	16	–
VMPA-FB-PS-P1	16	–
VMPA-FB-EMG-P1	16	16
VMPAL-EPL-CPX	–	4, 8, 16, 24, 32 ¹⁾
VABA-S6-1-X1	–	8, 16, 24, 32 ¹⁾
VABA-S6-1-X2	–	8, 16, 24, 32 ¹⁾
VABA-S6-1-X2-D	8, 16, 24, 32 ¹⁾	8, 16, 24, 32 ¹⁾

1) Dependent on the DIL switch setting on the module

Terminal CPX

Technical data

 - Module width
50 mm



 - Note
The data given here apply to the CPX system. If components that conform to lower values are used in the system, the specification for the entire system is reduced to the values of those components used.

Example
Protection class IP65/IP67 applies only to the fully assembled system with fitted plugs or covers (which must also conform to IP65/IP67). If components with a lower protection class are used, the protection level of the entire

system is reduced to the protection class of the component with the lowest protection level, for example CageClamp connection block with IP20 protection or MPA pneumatics with IP65 protection.

General technical data			
Module No.		197330	
Max. no. of modules ¹⁾	Control block	1	
	Bus node	1	
	I/O modules/CP interface/CTEL interface/ electrical interface CPX-CTEL-2/multi-axis interface	9	
	Pneumatic interface	1	
Max. address capacity	Inputs	[byte]	64
	Outputs	[byte]	64
Internal cycle time		[ms]	< 1
Configuration support	Fieldbus-specific		
LED displays	Bus node/control block		Up to 4 LEDs, bus-specific 4 LEDs, CPX-specific • PS = Power system • PL = Power load • SF = System fault • M = Modify parameter/forcing active
	I/O modules		Min. one group diagnostic LED Channel-oriented status and diagnostic LED, depending on module
	Pneumatic interface		One group diagnostic LED Valve status LED on valve
Diagnostics	<ul style="list-style-type: none"> • Channel and module-oriented diagnostics for inputs/outputs and valves • Detection of module undervoltage for the different voltage potential values • Storage of the last 40 errors with timestamp (asynchronous access) 		

1) A maximum of 11 modules in total can be combined
(e.g. 1 control block + 9 I/O modules + 1 pneumatic interface, or 1 control block + 1 bus node + 8 I/O modules + 1 pneumatic interface)

Terminal CPX

Technical data

FESTO

General technical data			
Module No.		197330	
Parameterisation		Module-specific and entire system, for example: <ul style="list-style-type: none"> • Diagnostic behaviour • Condition monitoring • Profile of inputs • Fail-safe response of outputs and valves 	
Commissioning support		Forcing of inputs and outputs	
Protection class to EN 60529		IP65, IP67	
Nominal operating voltage	[V DC]	24	
Operating voltage range	[V DC]	18 ... 30	
Current supply	Interlinking block with system supply for electronics plus sensors	[A]	16 (8/10 with 7/8" supply, 5-pin/4-pin)
	actuators plus valves	[A]	16 (8/10 with 7/8" supply, 5-pin/4-pin)
	Additional power supply for actuators	[A]	16 (8/10 with 7/8" supply, 5-pin/4-pin)
	Additional power supply for valves	[A]	16 (10 with 7/8" supply, 4-pin)
Current consumption		Depending on system configuration	
Power failure bridging (bus electronics only)	[ms]	10	
Power supply connection			M18, 4-pin
			7/8", 5-pin
			7/8", 4-pin
			AIDA push-pull, 5-pin
Fuse concept		Per module with electronic fuses	
Tests	Vibration test to DIN IEC 68		<ul style="list-style-type: none"> • With wall mounting: Severity level 2 • With H-rail mounting: Severity level 1
	Shock test to DIN IEC 68		<ul style="list-style-type: none"> • With wall mounting: Severity level 2 • With H-rail mounting: Severity level 1
PWIS classification		PWIS-free (free of paint-wetting impairment substances)	
Interference immunity		EN 61000-6-2 (industry)	
Interference emission		EN 61000-6-4 (industry)	
Isolation test for galvanically isolated circuits to IEC 1131 Part 2	[V DC]	500	
Galvanic isolation of electrical voltages	[V DC]	80	
Protection against direct and indirect contact		PELV (Protective Extra-Low Voltage)	
Materials		End plates: Die-cast aluminium	
Grid dimension	[mm]	50	

Operating and environmental conditions		
Module No.		197330
Ambient temperature	[°C]	-5 ... +50
Storage temperature	[°C]	-20 ... +70

Terminal CPX

Technical data

FESTO

Certifications – Maximum permissible values	
Module No.	197330
ATEX category gas	II 3G
Ex-ignition protection type gas	Ex nA IIC T4 X Gc
ATEX ambient temperature [°C]	-5 ≤ Ta ≤ +50
CE mark (see declaration of conformity)	To EU Explosion Protection Directive (ATEX) To EU EMC Directive ¹⁾
Protection class to EN 60529	IP65, IP67
Certification	c UL us - Recognized (OL) C-Tick
Explosion protection certification outside the EU	EPL Gc (Ru)

1) For information about the applicability of the component see the manufacturer's EC declaration of conformity at: www.festo.com/sp → Certificates.
If the component is subject to restrictions on usage in residential, office or commercial environments or small businesses, further measures to reduce the emitted interference may be necessary.

 Note

The values indicated represent the maximum performance limits that can be achieved with the fully assembled product. Depending on the individual components used, the value actually achieved for the overall product may be lower.

You can select e.g. the individual components required to achieve the ATEX category by choosing the corresponding features in the online product configurator: [→ Internet:cpx](https://www.festo.com/sp)

Weight [g]					
Control block	CEC	155.0	Connection block	Plastic	70.0
	CEC...V3	135.0		Metal	175.0
Bus node	FB6	125.0	Interlinking block, plastic	Without power supply	100.0
	FB11	120.0		With system supply	125.0
	FB13	115.0	Interlinking block, metal	Without power supply	169.0
	FB14	115.0		With system supply, 7/8" 4-pin	228.0
	FB21	1255.0		With system supply, 7/8" 5-pin	187.0
	FB23-24	115.0		With system supply, Push-pull	279.0
	FB33	280.0	Tie rod	1-fold	19.0 ±2.5
	FB34	280.0		2-fold	32.5 ±2.5
	FB35	280.0		3-fold	46.0 ±2.5
	FB36	125.0		4-fold	59.5 ±2.5
	FB37	125.0		5-fold	73.0 ±2.5
	FB38	125.0		6-fold	86.5 ±2.5
	FB39	125.0		7-fold	100.0 ±2.5
	FB40	125.0		8-fold	113.5 ±2.5
FB41	280.0	9-fold		127.0 ±2.5	
		10-fold		140.5 ±2.5	
I/O module	CPX	38.0	End plate for plastic version	Left-hand	77.0
	CPX-L	170.0		Left-hand, with system supply	145.0
	HART	77.4	Right-hand	70.0	
Counter module	2ZE2DA	130.0	End plate for metal version	Left-hand	113.0
CP interface	CP	140.0		Right-hand	113.0
CTEL interface	CTEL	110.0	End plate with extension	Left-hand	190.0
Electrical interface	CTEL-2	110.0		Right-hand	175.0
Axis interface	CM-HPP	140.0	Pneumatic interface	MPA-S	238.4
Axis controller	CMAX	140.0		VTSA/VTSA-F	485.0
End-position controller	CMPX	140.0			
Measuring module	CMIX	140.0			

Terminal CPX

Accessories

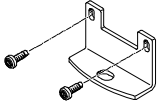
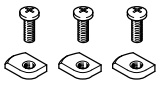
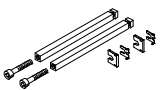
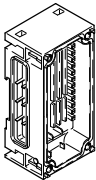
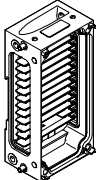

FESTO

Ordering data – Accessories				
Designation			Part No.	Type
Mounting				
	Attachment for wall mounting (for long valve terminals, 10 pieces), design for plastic manifold sub-bases		529040	CPX-BG-RW-10x
	Attachment for wall mounting, design for metal manifold sub-bases	2 mounting brackets and 4 screws	550217	CPX-M-BG-RW-2X
		1 mounting bracket and 2 screws	2721419	CPX-M-BG-VT-2X
	Mounting for H-rail	CPX without pneumatic components	526032	CPX-CPA-BG-NRH
		CPX-VTSA		
		CPX-VTSA-F		
		CPX-MPA		
Tie rod				
	Tie rod CPX	Extension 1-fold	525418	CPX-ZA-1-E
		1-fold	195718	CPX-ZA-1
		2-fold	195720	CPX-ZA-2
		3-fold	195722	CPX-ZA-3
		4-fold	195724	CPX-ZA-4
		5-fold	195726	CPX-ZA-5
		6-fold	195728	CPX-ZA-6
		7-fold	195730	CPX-ZA-7
		8-fold	195732	CPX-ZA-8
		9-fold	195734	CPX-ZA-9
		10-fold	195736	CPX-ZA-10
Plastic interlinking block				
	Without power supply	–	195742	CPX-GE-EV
	With system supply	M18	195746	CPX-GE-EV-S
		M18, for ATEX environment	8022170	CPX-GE-EV-S-VL
		7/8" – 5-pin	541244	CPX-GE-EV-S-7/8-5POL
		7/8" – 5-pin, for ATEX environment	8022172	CPX-GE-EV-S-7/8-5POL-VL
		7/8" – 4-pin	541248	CPX-GE-EV-S-7/8-4POL
	With additional power supply for outputs	M18	195744	CPX-GE-EV-Z
		M18, for ATEX environment	8022166	CPX-GE-EV-Z-VL
		7/8" – 5-pin	541246	CPX-GE-EV-Z-7/8-5POL
		7/8" – 5-pin, for ATEX environment	8022173	CPX-GE-EV-Z-7/8-5POL-VL
		7/8" – 4-pin	541250	CPX-GE-EV-Z-7/8-4POL
	With additional power supply for valves	M18	533577	CPX-GE-EV-V
		M18, for ATEX environment	8022171	CPX-GE-EV-V-VL
7/8" – 4-pin		541252	CPX-GE-EV-V-7/8-4POL	
Metal interlinking block				
	Without power supply	–	550206	CPX-M-GE-EV
	With system supply	7/8" – 5-pin	550208	CPX-M-GE-EV-S-7/8-5POL
		7/8" – 5-pin, for ATEX environment	8022165	CPX-M-GE-EV-S-7/8-5POL-VL
		7/8" – 4-pin	568956	CPX-M-GE-EV-S-7/8-CIP-4P
		Push-pull – 5-pin	563057	CPX-M-GE-EV-S-PP-5POL
	With additional power supply for outputs	7/8" – 5-pin	550210	CPX-M-GE-EV-Z-7/8-5POL
		7/8" – 5-pin, for ATEX environment	8022158	CPX-M-GE-EV-Z-7/8-5POL-VL
		Push-pull – 5-pin	563058	CPX-M-GE-EV-Z-PP-5POL

Terminal CPX

Accessories

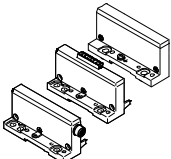
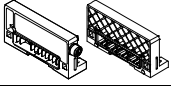
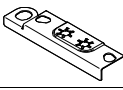
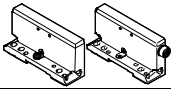
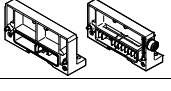
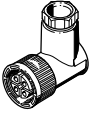
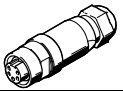
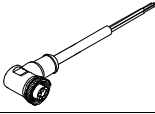
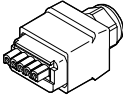



FESTO

Ordering data – Accessories				
Designation			Part No.	Type
Mounting accessories				
	Screws for mounting the bus node/connection block on a plastic interlinking block	Bus node/metal connection block	550218	CPX-DPT-30X32-S-4X
	Screws for mounting the bus node/connection block on a metal interlinking block	Bus node/plastic connection block	550219	CPX-M-M3x22-4x
		Bus node/metal connection block	550216	CPX-M-M3x22-S-4x
End plates for plastic version				
	End plate, left-hand	–	195716	CPX-EPL-EV
		With system supply	576315	CPX-EPL-EV-S
		With extension	576314	CPX-EPL-EV-X
	End plate, right-hand	–	195714	CPX-EPR-EV
		With extension	576313	CPX-EPR-EV-X
	Earthing element for right-hand/left-hand end plate	5 pieces	538892	CPX-EPFE-EV
End plates for metal version				
	End plate, left-hand	–	550212	CPX-M-EPL-EV
		With extension	576317	CPX-M-EPL-EV-X
	End plate, right-hand	–	550214	CPX-M-EPR-EV
		With extension	576316	CPX-M-EPR-EV-X
Power supply				
	Plug socket for mains connection M18x1, straight, 4-pin	For 1.5 mm ²	18493	NTSD-GD-9
		For 2.5 mm ²	18526	NTSD-GD-13,5
	Plug socket for mains connection M18x1, angled, 4-pin	For 1.5 mm ²	18527	NTSD-WD-9
		For 2.5 mm ²	533119	NTSD-WD-11
	Plug socket for mains connection 7/8", straight, 5-pin	0.25 ... 2.0 mm ²	543107	NECU-G78G5-C2
		Plug socket for mains connection 7/8", straight, 4-pin	0.25 ... 2.0 mm ²	543108
	Plug socket for mains connection 7/8", angled, 5-pin – open cable end, 5-wire	2 m	573855	NEBU-G78W5-K-2-N-LE5
	Power supply socket push-pull, connection pattern PP, fulfils requirements according to AIDA	5-pin	5195383	NECU-M-PPG5PP-C1-PN
	Straight plug, spring-loaded terminal, for end plate left-hand with system supply	7-pin	576319	NECU-L3G7-C1

Terminal CPX

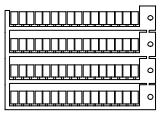
Accessories

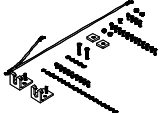
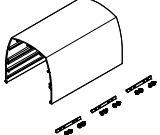
FESTO

Ordering data – Accessories				
Designation			Part No.	Type
Inscription labels				
	Inscription labels 6x10, 64 pieces, in frames		18576	IBS-6x10
Hood				
	Mounting rail for securing the cover	1,000 mm	572256	CAFC-X1-S
	Mounting kit for CPX cover		572257	CAFC-X1-BE
	Hood section for CPX terminal including mounting attachments for connecting several hood sections in series	200 mm	572258	CAFC-X1-GAL-200
		300 mm	572259	CAFC-X1-GAL-300
Manual				
	CPX System Manual	German	526445	P.BE-CPX-SYS-DE
		English	526446	P.BE-CPX-SYS-EN
		Spanish	526447	P.BE-CPX-SYS-ES
		French	526448	P.BE-CPX-SYS-FR
		Italian	526449	P.BE-CPX-SYS-IT
	Operator unit CPX-MMI-1	German	534824	P.BE-CPX-MMI-1-DE
		English	534825	P.BE-CPX-MMI-1-EN
		French	534827	P.BE-CPX-MMI-1-FR
		Italian	534828	P.BE-CPX-MMI-1-IT
		Spanish	534826	P.BE-CPX-MMI-1-ES

Terminal CPX

Accessories

User manuals – General information

Comprehensive user manuals are vital for the fast and reliable use of fieldbus components. The manuals provided by Festo contain step-by-step instructions for using CPX terminals:

1. Installation
2. Commissioning and parameterisation
3. Diagnostics

Application-oriented explanations are provided for integration of the CPX terminal in the programming and configuration software of the various controller manufacturers.

Use the order code to select the language you want.

The manual for the configuration you have ordered is supplied automatically.

The documents can be quickly and easily downloaded from the Festo website.

➔ www.festo.com



Overview – User manuals

Type	Title	Description
Pneumatic components		
P.BE-VTSA-44-...	Valve terminals with VTSA and VTSA-F pneumatics	Instructions on assembly, installation, commissioning and diagnostics of the VTSA and VTSA-F pneumatic components.
P.BE-MPA-...	Valve terminals with MPA-S pneumatics	Instructions on assembly, installation, commissioning and diagnostics of the MPA-S pneumatic components.
MPAL-VI-...	Valve terminals	Instructions on assembly, installation, commissioning and diagnostics of the MPA-L pneumatic components.

Overview – User manuals		
Type	Title	Description
Electronic components		
P.BE-CPX-SYS-...	System description, installation and commissioning	Overview of the design, components and mode of operation of the CPX terminal; installation and commissioning instructions as well as basic principles of parameterisation
P.BE-CPX-FVDA-P2-...	PROFIsafe shut-off module	Connection technology and instructions on mounting, installing and commissioning for the PROFIsafe shut-off module of the type CPX-FVDA-P2
P.BE-CPX-EA-...	CPX-EA modules, digital	Connection technology and assembly, installation and commissioning instructions for digital input and output modules of the type CPX-... as well as VTSA/VTSA-F and MPA-S/L pneumatic interface
P.BE-CPX-F8DE-P-...	Input module CPX-F8DE-P	Connection technology and assembly, installation and commissioning instructions for PROFIsafe input module of the type CPX-F8DE-P
P.BE-CPX-2ZE2DA-...	EA module CPX-2ZE2DA	Connection technology and instructions on mounting, installing and commissioning for the counter module of the type CPX-2ZE2DA
P.BE-CPX-AX-...	CPX-EA modules, analogue	Connection technology and assembly, installation and commissioning instructions for analogue input and output modules of the type CPX-...
P.BE-CPX-CP-...	CPX CP interface	Instructions on assembly, installation, commissioning and diagnostics of the CP interface
P.BE-CPX-CTEL-...	CPX CTEL interface	Instructions on assembly, installation, commissioning and diagnostics of the CPX CTEL master
P.BE-CPX-CTEL-LK-...	Electrical interface CPX-CTEL-2	Instructions on assembly, installation, commissioning and diagnostics of the electrical interface CPX for IO-Link
CPX-CM-HPP-...	CPX axis interface	Instructions on assembly, installation, commissioning and diagnostics of the CPX axis interface (CM-HPP)
P.BE-CPX-CMAX-SYS-...	CPX axis controller	Instructions on assembly, installation, commissioning and diagnostics of the CPX axis controller (CMAX)
P.BE-CPX-CMAX-CONTROL-...	CPX axis controller	Information on controlling, diagnosing and parameterising the axis controller via the fieldbus
P.BE-CPX-CMPX-SYS-...	CPX end-position controller	Instructions on assembly, installation, commissioning and diagnostics of the CPX end-position controller (CMPX)
P.BE-CPX-CMIX-...	CPX measuring module	Instructions on assembly, installation, commissioning and diagnostics of the CPX measuring module (CMIX)
P.BE-CPX-FB-... CPX-FB-...	CPX bus node	Instructions on assembly, installation, commissioning and diagnostics of the relevant bus nodes
P.BE-CPX-PNIO-...	CPX bus node for PROFINET	Instructions on assembly, installation, commissioning and diagnostics of the relevant bus nodes
P.BE-CPX-CEC-...	CPX CoDeSys controller (control block)	Instructions on assembly, installation, commissioning and diagnostics of the relevant control block
P.BE-CPX-MMI-1-...	Universal handheld type CPX-MMI-1	Instructions on assembly, installation, commissioning and diagnostics of the CPX operator unit

User manuals – GSD, EDS, etc.

Device description files and icons are used to explain the integration of the CPX terminal in the configuration software of the various controller manufacturers.

These can be downloaded quickly and easily from www.festo.com.

Terminal CPX

Technical data – Operator unit CPX-MMI-1

FESTO

-  - Width
81 mm

The operator unit is a small, convenient commissioning and service device for the CPX terminal. It provides data polling, configuration and diagnostic functions for CPX terminals. Its extremely flexible application range means that data can be read in or out at any location. IP65 compatibility makes it suitable for use in harsh industrial environments.



Application

Functions

- Advance commissioning through the monitoring/forcing of inputs and outputs without fieldbus master/PLC
- Test function for parameter settings, for example fail-safe of the outputs or switch-on delay of the inputs
- Plain-text diagnostics of module and channel-oriented errors
- Condition monitoring: preselection/loading of counters, activation of the channels to be monitored
- Display of the last 40 error occurrences with timestamp
- Identification of sporadic causes of errors through display of the diagnostic history
- Password protection

Connection

The operator unit is connected to the CPX bus nodes or control block, as appropriate, using a M12 connecting cable.
The voltage for the operator unit is supplied by the CPX component

Communication

Once connected to the CPX terminal, the operator unit loads the available configuration for the I/O modules, valves, etc.
This ensures the availability of up-to-date texts, messages, menus and displays.
Status information, diagnostic messages and parameter bits are then exchanged during operation.

Assembly

A mounting bracket for the operator unit offers the option of wall or H-rail mounting.
The mounting bracket also has an option for temporary mounting using a hanging device.

Terminal CPX

Technical data – Operator unit CPX-MMI-1

Connection

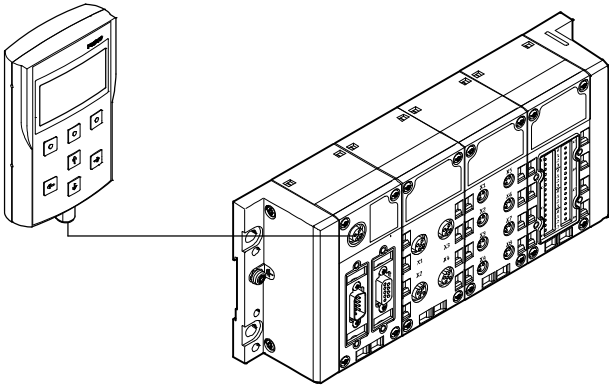

The operator unit is connected to the CPX terminal using a pre-assembled connecting cable.

Function examples

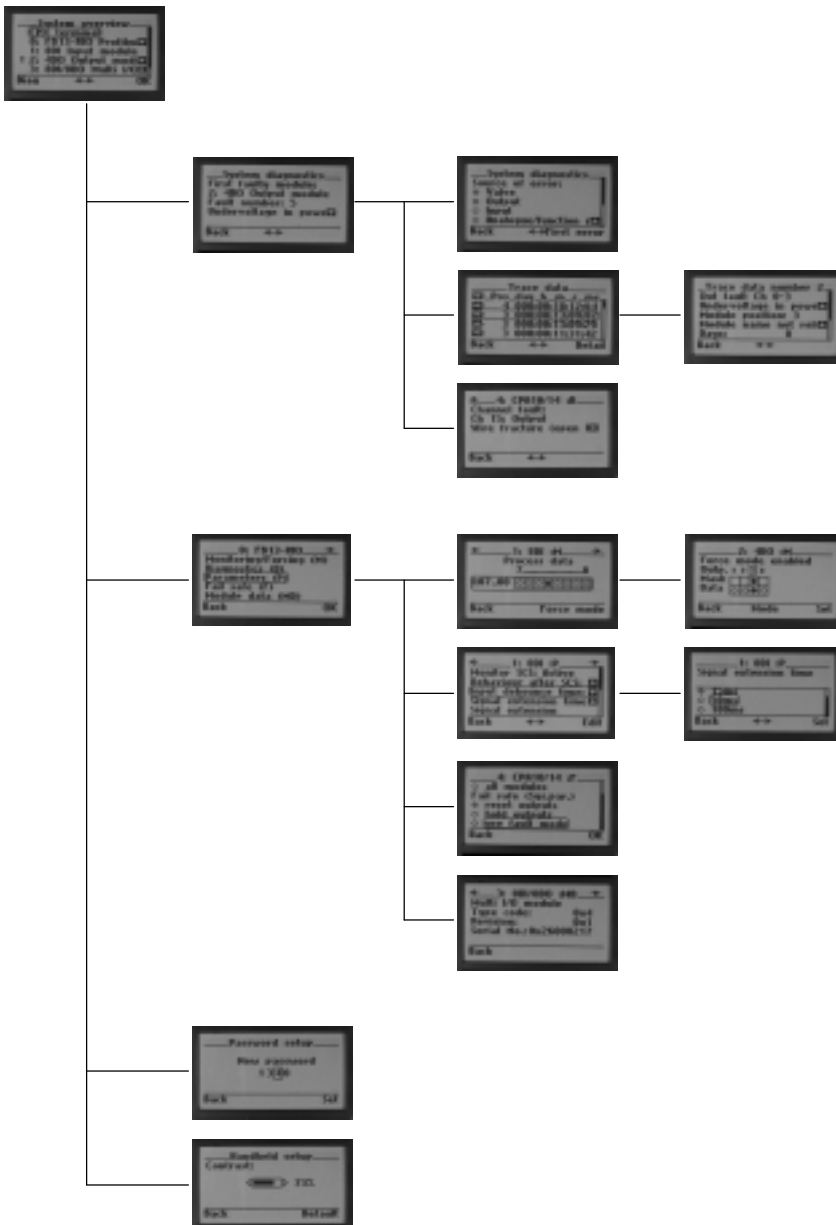

System overview

- Overview of configured modules and current diagnostic messages

Diagnostics

- Fast access to the diagnostic history and the modules with diagnostic messaging
- Display of the last 40 diagnostic messages with timestamp
- Display of the current diagnostic message for a module

Commissioning

- Selection of module-specific data and parameters
- Display and modification of the current status of the inputs and outputs of a module
- Display and modification of the current settings for module-specific parameters

Setup

- Setting of access permission (password)
- Contrast setting of the display

Terminal CPX

Technical data – Operator unit CPX-MMI-1

General technical data		
Type	CPX-MMI-1	
Data interface	RS232 interface, 57.6 kBaud, M12 socket, 4-pin	
Display component	LCD graphical display with background illumination (128 x 64 pixels)	
Control elements	7 keys: 4 arrow keys and 3 function keys, touch-sensitive keypad	
Electromagnetic compatibility	Interference emission tested to DIN EN 61000-6-4, industry	
	Interference immunity tested to DIN EN 61000-6-2, industry	
Nominal operating voltage	[V DC]	24, supplied by the connected device
Operating voltage range	[V DC]	18 ... 30
Current consumption	[mA]	50 ... 60
Protection class to IEC 60529	IP65	
Relative air humidity	[%]	90, non-condensing
Vibration resistance	Tested to DIN/IEC 68/EN 60068, Part 2-6	
	<ul style="list-style-type: none"> • With wall mounting: Severity level 2 • With H-rail mounting: Severity level 1 	
Shock resistance	Tested to DIN/IEC 68/EN 60068, Part 2-27	
	<ul style="list-style-type: none"> • With wall mounting: Severity level 2 • With H-rail mounting: Severity level 1 	
Materials	Reinforced PA	
Dimensions (W x H x D)	[mm]	81 x 137 x 28
Weight	[g]	150

Operating and environmental conditions		
Ambient temperature	[°C]	0 ... 50
CE mark (see declaration of conformity)	To EU EMC Directive ¹⁾	
	In accordance with EU Explosion Protection Directive (ATEX)	
ATEX category	Gas	II 3 G
	Dust	II 3 D
EX-ignition protection type	Gas	Ex nA IIC T6 X Gc
	Dust	Ex tc IIIC T60°C X Dc IP65
ATEX ambient temperature	[°C]	-5 ≤ Ta ≤ +50

1) For information about the applicability of the component see the manufacturer's EC declaration of conformity at: www.festo.com/sp → Certificates.
If the component is subject to restrictions on usage in residential, office or commercial environments or small businesses, further measures to reduce the emitted interference may be necessary.

Note

When operating device combinations in hazardous areas, the lowest ambient temperature of the individual devices determine the possible common zone, temperature class and use of the entire module.

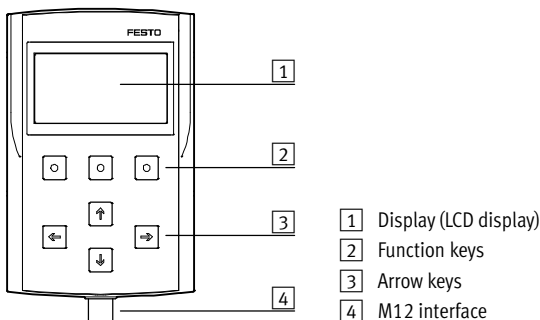

Connection and display components



Terminal CPX

Accessories – Operator unit CPX-MMI-1

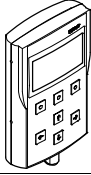
FESTO

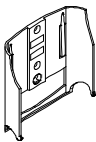
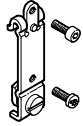
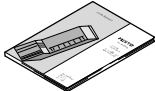
Ordering data				
Designation			Part No.	Type
Operator unit				
	Provides data polling, configuration and diagnostic functions for CPX terminals		529043	CPX-MMI-1
Connecting cable				
	Connecting cable M12-M12, specially for CPX-MMI		1.5 m	529044 KV-M12-M12-1,5
			3.5 m	530901 KV-M12-M12-3,5
Mounting				
	Bracket		534705	CPX-MMI-1-H
	Mounting for H-rail		536689	CPX-MMI-1-NRH
User manual				
	User manual for operator unit CPX-MMI-1		German	534824 P.BE-CPX-MMI-1-DE
			English	534825 P.BE-CPX-MMI-1-EN
			French	534827 P.BE-CPX-MMI-1-FR
			Italian	534828 P.BE-CPX-MMI-1-IT
			Spanish	534826 P.BE-CPX-MMI-1-ES

Terminal CPX

Technical data – CPX Maintenance Tool

Function

CPX Maintenance Tool (CPX-FMT) combines service software with a connecting adapter. The service software is a tool for the design, parameterisation and online diagnostics of the CPX terminal. The USB-to-M12 adapter features built-in galvanic isolation (between CPX and PC) and enables a PC to be connected to the diagnostic interface of the CPX terminal.

- Adapter
- Software on CD-ROM

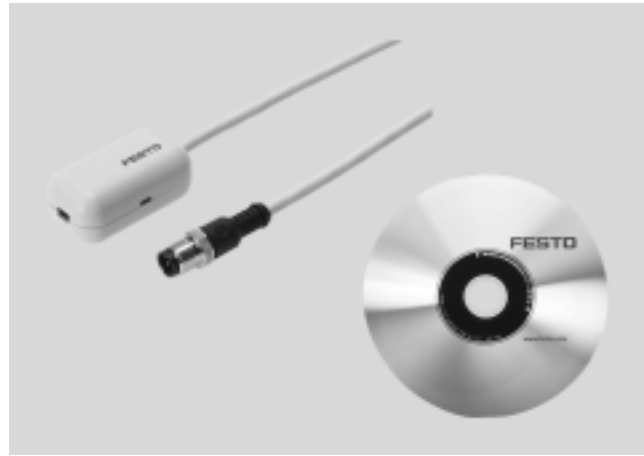

Application

Only from Festo

The CPX-FMT software enables access to CPX valve terminals via Ethernet and the bus nodes EtherNet/IP (FB 36), Sercos III (FB 39) and PROFINET (FB 33, FB 34, FB 35, FB 41). The bus nodes or control block can be connected directly to the PC via a USB adapter from Festo. Similar to the CPX-MMI, diagnostic data such as

the error trace or module diagnostics can be read out and parameters can be modified in plain text. In contrast to the CPX-MMI, the data can be used directly on a PC. There is an option, for example, to send screenshots of a configuration or the current error trace directly via e-mail. In addition, CPX configurations can also be saved

and archived directly as a CPX-FMT project. Undocumented changes can subsequently be identified using the online/offline comparison function. On-site tests such as the actuation of valves or the emulation of sensor feedback (in both cases called “forcing”), for example, can be

performed without an existing controller infrastructure. It must be noted that with both the CPX-FMT and the CPX-MMI, only local parameters on the CPX valve terminal can be changed and saved. The configuration of the networks or controller software cannot be influenced.

General technical data		NEFC-M12G5-0.3-U1G5
Type		
System requirements	PC	IBM-compatible
	Drive	CD-ROM
	Interfaces	USB port (specification USB 1.1 or higher)
	Operating system	Microsoft Windows 2000 or XP
Functional range		<ul style="list-style-type: none"> • Configuration and parameterisation • Reading out of system, module, channel diagnostics and error trace • Saving of the configuration as a project • Integration of plug-ins/links to self-executing programs
Scope of delivery		<ul style="list-style-type: none"> • Adapter M12, 5-pin to mini USB socket • CD-ROM with installation program
Type of mounting		Screw-in
Electrical connection		Plug M12x1, 5-pin
Adapter cable composition		4 x 0.34 mm ²
Cable length	[m]	0.3
Protection class to EN 60529		IP20
CE mark (see declaration of conformity)		To EU EMC Directive
Ambient temperature	[°C]	-5 ... +50
Material	Housing	ABS
	Cable sheath	PUR
	Pin contact	Gold-plated brass
Note on materials		RoHS-compliant

Display components

Creating a device configuration using the editor

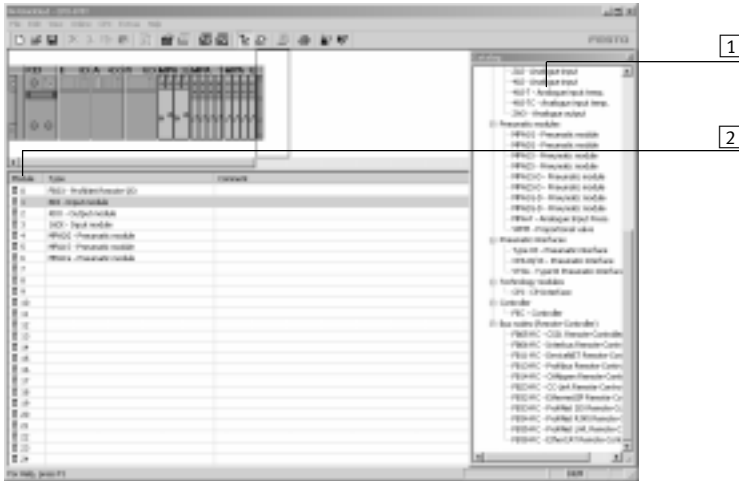

The device configuration can be conveniently generated, parameterised and saved using the drag & drop feature. You can insert and move modules.

- 1 Module numbers from the graphic system overview
- 2 Catalogue for selecting required modules

Module overview for a selected module

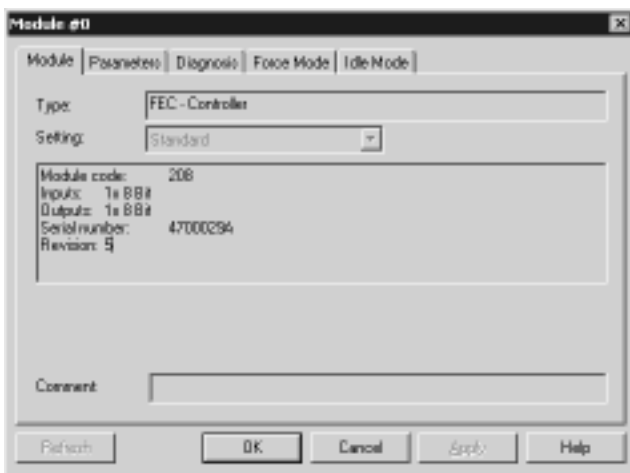

Displays important module data as well as the number of allocated inputs and outputs.

Diagnostic memory

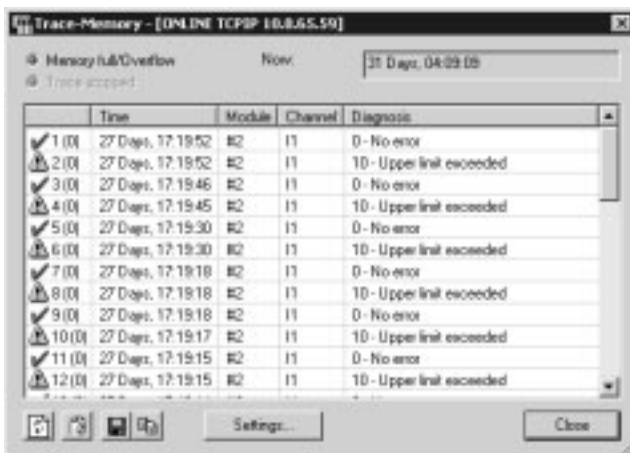

Faults which occur during operation are entered in a diagnostic memory. The first or the last 40 entries are saved, as well as the respective time measured from the moment the power supply was switched on.

Terminal CPX

Technical data – CPX Maintenance Tool

Dimensions

Download CAD data → www.festo.com

Adapter

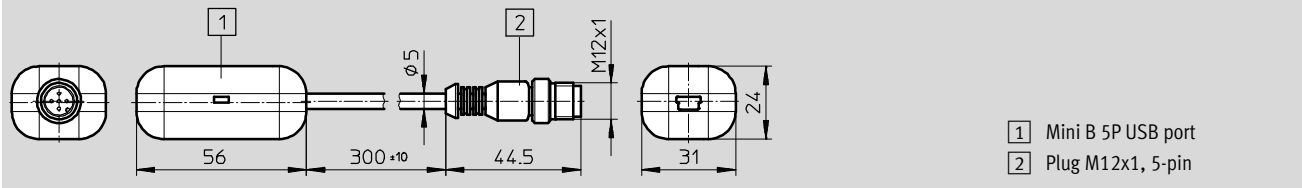

Ordering data

Designation	Part No.	Type
 CPX Maintenance Tool (CPX-FMT), software and USB-to-M12 adapter	547432	NEFC-M12G5-0.3-U1G5

Terminal CPX

Technical data – Control block CPX-CEC

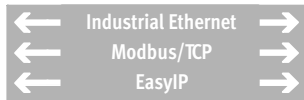

IT services:



The CODESYS controller is a modern control system for CPX terminals that enables programming with CODESYS to IEC 61131-3.

The power supply to and communication with other modules takes place via the interlinking block.

In addition to network connections, LEDs are also provided for the bus status, operating status of the PLC and CPX peripherals information, as are switching elements and a diagnostic interface for CPX-MMI and CPX-FMT.

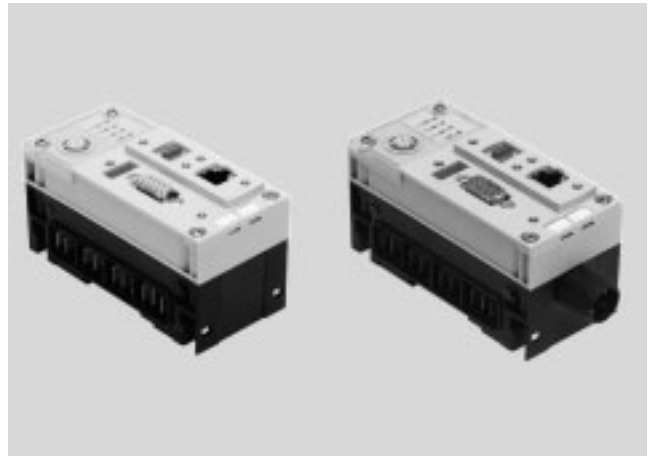

Application			
Bus connection		Communication protocols	Operating modes
The CPX-CEC is a remote controller that can be connected to a master PLC via the fieldbus nodes of the CPX terminal or via Ethernet. At the same	time, it is possible to operate the CPX-CEC as a compact stand-alone controller directly on the machine.	<ul style="list-style-type: none"> Fieldbus via CPX fieldbus nodes Modbus/TCP EasyIP 	<ul style="list-style-type: none"> Stand-alone Remote controller, fieldbus Remote controller, Ethernet
Setting options			
The CPX-CEC has the following interfaces for monitoring, programming and commissioning:	<ul style="list-style-type: none"> For the CPX-MMI/-FMT Ethernet interface for IT applications Remote diagnostics 	The operating mode and fieldbus protocol are set using the DIL switch on the CPX-CEC.	The integrated web server offers a convenient means of querying data saved in the CPX-CEC.
Features			
<ul style="list-style-type: none"> Easy actuation of valve terminal configurations with MPA, VTSA Diagnostics with flexible monitoring options for pressure, flow rate, cylinder operating time, air consumption 	<ul style="list-style-type: none"> Actuation of decentralised installation systems on the basis of CPI actuation of applications in proportional pneumatics AS-Interface actuation via gateway 	<ul style="list-style-type: none"> Connection to all fieldbuses as a remote controller and for pre-processing Actuation of electric drives as individual axes via CANopen (CPX-CEC-C1/-M1) 	<ul style="list-style-type: none"> Early warnings and visualisation options Closed-loop pneumatic applications

Terminal CPX

Technical data – Control block CPX-CEC

General technical data		
Protocol	CODESYS Level 2	
	EasyIP	
	Modbus TCP	
	TCP/IP	
Processing time	Approx. 200 µs/1 k instruction	
Programming software	CODESYS provided by Festo	
Programming language	To IEC 61131-3	
	Sequential function chart (SFC)	
	Instruction list (IL)	
	Function chart (FCH), additional continuous function chart (CFC)	
	Ladder diagram (LD)	
Programming	Operating language	German, English
	Support for file handling	Yes
Device-specific diagnostics	Diagnostic memory	
	Channel and module-oriented diagnostics	
	Undervoltage/short circuit of modules	
LED displays	Bus-specific	TP: Link/traffic
	Product-specific	RUN: PLC status
		STOP: PLC status
		ERR: PLC runtime error
		PS: Electronics supply, sensor supply
		PL: Load supply
		SF: System fault
		M: Modify/forcing active
IP address setting	DHCP	
	Via CODESYS	
	Via MMI	
Function blocks	CPX diagnostic status, copy CPX diagnostic trace, read CPX module diagnostics, etc.	
Dimensions (incl. interlinking block) W x L x H	[mm]	50 x 107 x 55

Materials	
Housing	Reinforced PA
	PC
Note on materials	RoHS-compliant

Operating and environmental conditions		
Ambient temperature	[°C]	–5 ... +50
Storage temperature	[°C]	–20 ... +70
Relative air humidity	[%]	95, non-condensing
Corrosion resistance class CRC ¹⁾		2

1) Corrosion resistance class CRC 2 to Festo standard FN 940070
Moderate corrosion stress. Indoor applications in which condensation may occur. External visible parts with primarily decorative requirements for the surface and which are in direct contact with the ambient atmosphere typical for industrial applications.

Electrical data			
Nominal operating voltage	[V DC]	24	
Load voltage	Nominal operating voltage	[V DC]	24
	With pneumatics type VTSA	[V DC]	21.6 ... 26.4
	With pneumatics type MPA	[V DC]	18 ... 30
	Without pneumatics	[V DC]	18 ... 30
Power failure buffering	[ms]	10	
Intrinsic current consumption at nominal operating voltage	[mA]	Typically 85	
Degree of protection to EN 60529		IP65, IP67	

Terminal CPX

Technical data – Control block CPX-CEC



Technical data				
Type		CPX-CEC-C1	CPX-CEC-C1-V3	CPX-CEC-M1-V3
Additional functions		Motion functions for electric drives		SoftMotion functions for electric drives
CPU data	Flash	[MB]	32	32
	RAM	[MB]	32	256
	Processor	[MHz]	400	800
Control interface		CAN bus	CAN bus	CAN bus
Parameterisation		CODESYS V2.3	CODESYS V3	CODESYS V3
Configuration support		CODESYS V2.3	CODESYS V3	CODESYS V3
Program memory, user program		[MB]	4	16
Flags		CODESYS variable concept		
	Remanent data	[kB]	30	28
	Global data memory	[MB]	8	–
Control elements		DIL switch for CAN termination		
		Rotary switch for RUN/STOP		
Total number of axes		31	127	31
Ethernet	Number		1	
	Connection technology		RJ45 socket, 8-pin	
	Data transmission speed	[Mbps]	10/100	
	Supported protocols		TCP/IP, EasyIP, Modbus TCP	
Fieldbus interface	Number		1	
	Connection technology		Sub-D plug connector, 9-pin	
	Data transmission speed, can be set via software	[kbps]	125, 250, 500, 800, 1000	125, 250, 500, 800, 1000
	Supported protocols		CAN bus	
	Galvanic isolation		Yes	

Technical data				
Type		CPX-CEC	CPX-CEC-S1-V3	
CPU data	Flash	[MB]	32	
	RAM	[MB]	32	
	Processor	[MHz]	400	
Parameterisation		CODESYS V2.3	CODESYS V3	
Configuration support		CODESYS V2.3	CODESYS V3	
Additional functions		Diagnostic functions		
		RS232 communication function		
Program memory, user program		[MB]	4	
Flags		CODESYS variable concept		
	Remanent data	[kB]	30	
	Global data memory	[MB]	8	
Control elements		Rotary switch for RUN/STOP		
Ethernet	Number		1	
	Connection technology		RJ45 socket, 8-pin	
	Data transmission speed	[Mbps]	10/100	
	Supported protocols		TCP/IP, EasyIP, Modbus TCP	
Data interface	Number		1	
	Connection technology		Sub-D socket, 9-pin	
	Data transmission speed	[kbps]	9.6 ... 230.4	
	Supported protocols		RS232 interface	
	Max. cable length	[m]	–	30
	Galvanic isolation		Yes	

Terminal CPX

Technical data – Control block CPX-CEC

Connection and display components CPX-CEC-C1/-M1

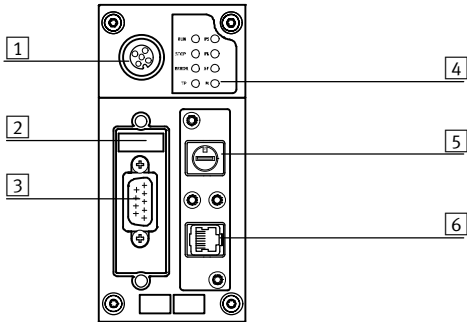

- 1 CPX-MMI connection
- 2 DIL switch
- 3 Fieldbus interface
(Sub-D plug connector, 9-pin)
- 4 Status LEDs, bus-specific and product-specific
- 5 RUN/STOP rotary switch
- 6 Ethernet interface (RJ45 socket, 8-pin)

Pin allocation – CPX-CEC-C1/-M1

	Pin	Signal	Meaning
Fieldbus interface, Sub-D plug connector			
	1	n.c.	Not connected
	2	CAN_L	CAN low
	3	CAN_GND	CAN ground
	4	n.c.	Not connected
	5	CAN_SHLD	Connection to functional earth FE
	6	CAN_GND	CAN ground (optional) ¹⁾
	7	CAN_H	CAN high
	8	n.c.	Not connected
	9	n.c.	Not connected
	Housing	Screening	Plug connector housing must be connected to FE
Ethernet interface, RJ45 plug connector			
	1	TD+	Transmitted data+
	2	TD-	Transmitted data-
	3	RD+	Received data+
	4	n.c.	Not connected
	5	n.c.	Not connected
	6	RD-	Received data-
	7	n.c.	Not connected
	8	n.c.	Not connected
	Housing	Screening	Screening

1) If a drive controller with external power supply is connected, CAN ground (optional), pin 6, on the CPX-CEC-C1/-M1 must not be used.

Terminal CPX

Technical data – Control block CPX-CEC

Connection and display components CPX-CEC/CPX-CEC-S1-V3

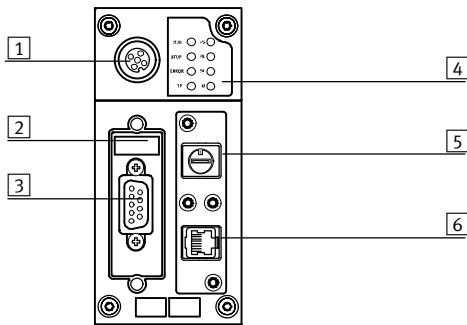

- 1 CPX-MMI connection
- 2 DIL switch
- 3 RS232 interface
(Sub-D socket, 9-pin)
- 4 Status LEDs, bus-specific and
product-specific
- 5 RUN/STOP rotary switch
- 6 Ethernet interface (RJ45 socket,
8-pin)

Pin allocation – CPX-CEC/CPX-CEC-S1-V3

	Pin	Signal	Meaning
RS232 interface, Sub-D socket			
	1	n.c.	Not connected
	2	RXD	Received data
	3	TXD	Transmitted data
	4	n.c.	Not connected
	5	GND	Data reference potential
	6	n.c.	Not connected
	7	n.c.	Not connected
	8	n.c.	Not connected
	9	n.c.	Not connected
	Screening	Screening	Connection to functional earth
Ethernet interface, RJ45 plug connector			
	1	TD+	Transmitted data+
	2	TD-	Transmitted data-
	3	RD+	Received data+
	4	n.c.	Not connected
	5	n.c.	Not connected
	6	RD-	Received data-
	7	n.c.	Not connected
	8	n.c.	Not connected
Housing	Screening	Screening	

Terminal CPX

Accessories – Control block CPX-FEC



Ordering data						
Designation				Part No.	Type	
Control block						
	Motion functions for electric drives		CODESYS V2.3	155 g	567347	CPX-CEC-C1
			CODESYS V3	135 g	3473128	CPX-CEC-C1-V3
	SoftMotion functions for electric drives		CODESYS V3	135 g	3472765	CPX-CEC-M1-V3
	RS232 communication function		CODESYS V2.3	155 g	567346	CPX-CEC
			CODESYS V3	135 g	3472425	CPX-CEC-S1-V3
Fieldbus interface						
	Sub-D plug connector, 9-pin, for CANopen			532219	FBS-SUB-9-BU-2x5POL-B	
	Connecting cable for RS232 interface			539642	FEC-KBG7	
	Connecting cable for RS232 interface			539643	FEC-KBG8	
	Micro Style bus connection, 2xM12 for DeviceNet/CANopen			525632	FBA-2-M12-5POL	
	Socket for Micro Style connection, M12			18324	FBSD-GD-9-5POL	
	Plug connector for Micro Style connection, M12			175380	FBS-M12-5GS-PG9	
	Open Style bus connection for 5-pin terminal strip for DeviceNet/CANopen			525634	FBA-1-SL-5POL	
	Terminal strip for Open Style connection, 5-pin			525635	FBSD-KL-2x5POL	
Ethernet interface						
	RJ45 plug connector		Protection class IP65, IP67		534494	FBS-RJ45-8-GS
	Cover for RJ45 connection		Protection class IP65, IP67		534496	AK-RJ45
	Straight plug, RJ45, 8-pin	Straight plug, M12x1, 4-pin, D-coded	Protection class IP20	1 m	8040451	NEBC-D12G4-ES-1-S-R3G4-ET
				3 m	8040452	NEBC-D12G4-ES-3-S-R3G4-ET
				5 m	8040453	NEBC-D12G4-ES-5-S-R3G4-ET
				10 m	8040454	NEBC-D12G4-ES-10-S-R3G4-ET
	Straight plug, RJ45, 8-pin	Straight plug, RJ45, 8-pin	Protection class IP20	1 m	8040455	NEBC-R3G4-ES-1-S-R3G4-ET

Terminal CPX

Accessories – Control block CPX-FEC

FESTO

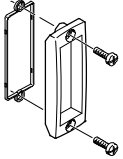
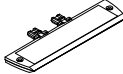
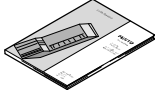
Ordering data				
Designation		Part No.	Type	
Covers and attachments				
	Inspection cover, transparent, for Sub-D connection	533334	AK-SUB-9/15-B	
	Inscription label holder for manifold block	536593	CPX-ST-1	
User documentation				
	Manual for control block CPX-CEC	German	569121	P.BE-CPX-CEC-DE
		English	569122	P.BE-CPX-CEC-EN

Terminal CPX

Technical data – Bus node CPX-FB6



Bus node for handling communication between the electrical CPX terminal and a higher-order master via INTERBUS.

The bus node is provided with system supply via the interlinking block and processes communication with the I/O modules.

The status of the CPX terminal is displayed as a common message via four CPX-specific LEDs.

The fieldbus communication status is displayed via four INTERBUS-specific LEDs.



Application

Bus connection

The bus connection is established via a 9-pin Sub-D socket and a 9-pin Sub-D plug with a typical INTERBUS pin allocation.

The bus connector plugs (with IP65/IP67 protection from Festo or IP20 protection from other manufacturers) facilitate the connection of the incoming and outgoing bus cable.

The outgoing bus plug contains the typical INTERBUS RBST bridge for identification of the outgoing bus connection.

The Sub-D interfaces are designed for controlling network components with a fibre-optic cable connection.

INTERBUS implementation

The CPX-FB6 supports the INTERBUS protocol to EN 50254.

In addition to synchronous I/O exchange, the optional PCP channel can be used for parameterisation and diagnostic functions.

The PCP channel provides access to advanced system information and assigns operation parameters while the controller is running via the user program.

An example of this is access to the integrated diagnostic memory function, i.e. storage of the last 40 errors with timestamp, module, channel and error type.

With its address capacity of 96 inputs and 96 outputs, the CPX-FB6 supports a large number of I/O module configurations, including pneumatic interface.

 Note
If the PCP channel is used, the maximum number of possible process data bits is reduced by 16.

Special points in combination with CPX-CEC

When a bus node is combined with a control block (CPX-CEC, in the fieldbus remote controller operating mode), the connected I/Os and/or valves, sensors and actuators are controlled via the CPX control block.

In this case, the bus node only provides the communication interface to the PLC.

Communication between the control block and CPX bus node is established

via the interlinking of the CPX modules and occupies an address capacity of the CPX system of:

- 8 byte outputs
- 8 byte inputs

The remaining address capacity of the control block or CPX system for actuating the peripherals is:

- 56 byte inputs
- 56 byte outputs

Terminal CPX

Technical data – Bus node CPX-FB6

FESTO

General technical data			CPX-FB6
Type			
Fieldbus interface			Sub-D, 9-pin, socket and pin
Baud rate		[Mbit/s]	0.5 and 2
Bus type			Remote bus
Ident. code			1, 2 or 3 (configuration-specific) 243 (PCP-channel activated)
Profile			12 (I/O device)
PCP channel			Yes, 16 bit (optional via DIL switch)
Configuration support			Icons for CMD software
Max. no. of process data bits	Inputs	[bit]	96
	Outputs	[bit]	96
LED displays (bus-specific)			UL = Operating voltage for INTERBUS interface RC = Remotebus check BA = Bus active RD = Remotebus disable TR = Transmit/receive
Device-specific diagnostics			Via peripherals error
Parameterisation			<ul style="list-style-type: none"> Start-up parameterisation via user functions (CMD) Via PCP communication
Additional functions			<ul style="list-style-type: none"> Storage of the last 40 errors with timestamp (access via PCP) 8-bit system status in image table for inputs 2-byte inputs and 2-byte outputs, system diagnostics in image table
Control elements			DIL switch
Operating voltage	Nominal value	[V DC]	24 (reverse polarity protected)
	Permissible range	[V DC]	18 ... 30
	Power failure buffering	[ms]	10
Current consumption			[mA] Typically 200
Protection class to EN 60529			IP65, IP67
Temperature range	Operation	[°C]	-5 ... +50
	Storage/transport	[°C]	-20 ... +70
Materials			PA-reinforced PC
Grid dimension			[mm] 50
Dimensions (incl. interlinking block) W x L x H			[mm] 50 x 107 x 50
Weight			[g] 125

 Note

Please observe the general limits and guidelines for the system when configuring the electrical modules.

Terminal CPX

Technical data – Bus node CPX-FB6

Connection and display components

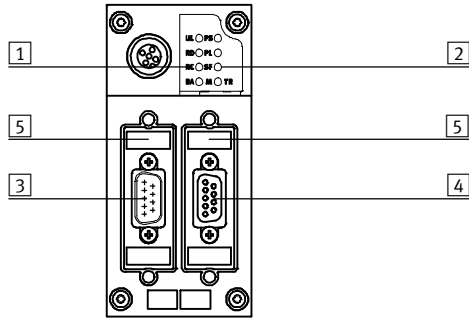

- 1 INTERBUS-specific LEDs
- 2 CPX-specific status LEDs
- 3 Fieldbus connection, incoming (9-pin Sub-D plug)
- 4 Fieldbus connection, outgoing (9-pin Sub-D socket)
- 5 DIL switch

Pin allocation for the INTERBUS interface

Pin allocation for Sub-D	Pin	Signal	Designation	Pin	Pin allocation for M12
Incoming					
	1	DO1	Data out	1	
	2	DI1	Data in	3	
	3	GND	Reference conductor/ground	5	
	4	n.c.	Not connected	2	
	5	n.c.	Not connected	4	
	6	/DO1	Data out inverse		
	7	/DI1	Data in inverse		
	8	n.c.	Not connected		
	9	n.c.	Not connected		
	Hous- ing	Screened	Connection to FE (functional earth) via R/C combination	Hous- ing	
Outgoing					
	1	DO2	Data out	1	
	2	DI2	Data in	3	
	3	GND	Reference conductor/ground	5	
	4	n.c.	Not connected	2	
	5	+5 V	Station detection ¹⁾	4	
	6	/DO2	Data out inverse		
	7	/DI2	Data in inverse		
	8	n.c.	Not connected		
	9	RBST	Station detection ¹⁾		
	Hous- ing	Screened	Connection to FE (functional earth)	Hous- ing	





The incoming interface is galvanically isolated from the CPX peripherals. The plug housing is connected to the functional earth FE of the CPX terminal via an R/C combination.

1) The CPX terminal contains the protocol chip SUP1 3 OPC. This ensures automatic detection of additional connected INTERBUS stations. There is therefore no need for a bridge between pin 5 and pin 9.

Terminal CPX

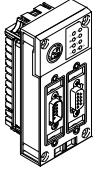
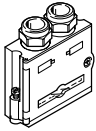
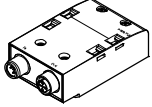
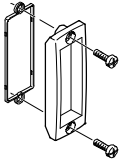
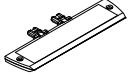
Accessories – Bus node CPX-FB6

FESTO

Ordering data				
Designation			Part No.	Type
Bus node				
	INTERBUS bus node		195748	CPX-FB6
Bus connection				
	Sub-D plug	Incoming	532218	FBS-SUB-9-BU-IB-B
		Outgoing	532217	FBS-SUB-9-GS-IB-B
	Connection block M12 adapter (B-coded)		534505	CPX-AB-2-M12-RK-IB
	Inspection cover, transparent		533334	AK-SUB-9/15-B
	Inscription label holder for connection block		536593	CPX-ST-1
	Threaded sleeve, 4 pieces		533000	UNC4-40/M3x6
	Adapter from 5-pin M12 to mini USB socket and controller software		547432	NEFC-M12G5-0.3-U1G5
User manual				
	User manual for bus node CPX-FB6	German	526433	P.BE-CPX-FB6-DE
		English	526434	P.BE-CPX-FB6-EN
		Spanish	526435	P.BE-CPX-FB6-ES
		French	526436	P.BE-CPX-FB6-FR
		Italian	526437	P.BE-CPX-FB6-IT

Terminal CPX

Technical data – Bus node CPX-FB11



Bus node for handling communication between the electrical CPX terminal and a DeviceNet network.

The bus node is provided with system supply via the interlinking block and processes communication with the I/O modules.

The status of the CPX terminal is displayed as a common message via four CPX-specific LEDs.

The fieldbus communication status is displayed via the three DeviceNet-specific LEDs.



Application

Bus connection

The bus connection can be selected when ordering, either Micro Style as 2xM12 round connectors or OpenStyle as a terminal strip with IP20 protection.

Both connection types have the function of an integrated T-distributor with incoming and outgoing bus line.

DeviceNet implementation

The CPX-FB11 operates with the “Predefined Master/Slave Connection Set” as a “Group 2 Only Server”. The polled I/O, change of state or synchronous method is used for the transmission of synchronous I/O data. The type of transmission can be selected in the network configuration.

The device diagnostics for all bus nodes CPX-FB11 is effectively gathered via strobed I/O and displayed in the input table of the controller. In addition to synchronous data transmission, asynchronous communication is supported through explicit messaging, which enables detailed device diagnostics and parameterisation.

A comprehensive EDS file supports the display of asynchronous data. It is also possible to display system information and assign parameters while the controller is running via the user program or the configuration software.

An example of this is access to the integrated diagnostic memory function, i.e. storage of the last 40 errors with timestamp, module, channel and error type. With its address capacity of 64 byte inputs and 64 byte outputs, the CPX-FB11 supports any configuration of I/O modules, including pneumatic interface.

Special points in combination with CPX-CEC

When a bus node is combined with a control block (CPX-CEC, in the fieldbus remote controller operating mode), the connected I/Os and/or valves, sensors and actuators are controlled via the CPX control block.

In this case, the bus node only provides the communication interface to the PLC. Communication between the control block and CPX bus node is established

via the interlinking of the CPX modules and occupies an address capacity of the CPX system of:

- 8 byte outputs
- 8 byte inputs

The remaining address capacity of the control block or CPX system for actuating the peripherals is:

- 56 byte inputs
- 56 byte outputs

Terminal CPX

Technical data – Bus node CPX-FB11

FESTO

General technical data			
Type	CPX-FB11		
Fieldbus interface	Either <ul style="list-style-type: none"> • Micro Style bus connection: 2xM12 with IP65, IP67 protection • Open Style bus connection: 5-pin terminal strip, IP20 		
Baud rate	[kbps]	125, 250, 500	
Addressing range	0 ... 63 Set using DIL switch		
Product	Type	Communication adapter (12 dec.)	
	Code	4554 dec.	
Communication types	Polled I/O, change of state/synchronous, strobed I/O and explicit messaging		
Configuration support	EDS file and bitmaps		
Max. address capacity	Inputs	[byte]	64
	Outputs	[byte]	64
LED displays (bus-specific)	MS = Module status NS = Network status IO = I/O status		
Device-specific diagnostics	Module and channel-oriented diagnostics by means of manufacturer-specific diagnostic object		
Parameterisation	<ul style="list-style-type: none"> • Module and system parameterisation via configuration interface in plain text (EDS) • Online in run or program mode 		
Additional functions	<ul style="list-style-type: none"> • Storage of the last 40 errors with timestamp (access via EDS) • 8-bit system status in image table for inputs • 2-byte inputs and 2-byte outputs, system diagnostics in image table 		
Control elements	DIL switch		
Operating voltage	Nominal value	[V DC]	24
	Permissible range	[V DC]	18 ... 30
	Power failure buffering	[ms]	10
Current consumption			[mA] Typically 200
Protection class to EN 60529	IP65, IP67		
Temperature range	Operation	[°C]	-5 ... +50
	Storage/transport	[°C]	-20 ... +70
Materials	PA-reinforced PC		
Grid dimension			[mm] 50
Dimensions (incl. interlinking block) W x L x H			[mm] 50 x 107 x 50
Weight			[g] 120

 Note

Please observe the general limits and guidelines for the system when configuring the electrical modules.

Terminal CPX

Technical data – Bus node CPX-FB11

Connection and display components

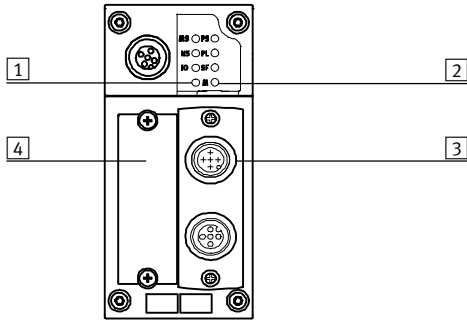

- 1 Bus-specific LEDs
- 2 CPX-specific status LEDs
- 3 Selectable fieldbus connection
Micro Style
Open Style
- 4 DIL switch cover

Pin allocation for the DeviceNet interface







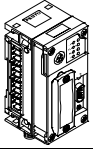
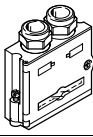

Pin allocation	Pin	Signal-specific core colour ¹⁾	Signal	Designation
Sub-D plug				
	1	–	n.c.	Not connected
	2	Blue	CAN_L	Received/transmitted data low
	3	Black	0 V bus	0 V CAN interface
	4	–	n.c.	Not connected
	5	Blank	Screened	Connection to housing
	6	–	n.c.	Not connected
	7	White	CAN_H	Received/transmitted data high
	8	–	n.c.	Not connected
	9	Red	24 V DC bus	24 V DC supply for CAN interface
Micro Style bus connection (M12), incoming/outgoing				
Incoming 	1	Blank	Screened	Connection to housing
	2	Red	24 V DC bus	24 V DC supply for CAN interface
	3	Black	0 V bus	0 V CAN interface
	4	White	CAN_H	Received/transmitted data high
	5	Blue	CAN_L	Received/transmitted data low
Outgoing 	1	Blank	Screened	Connection to housing
	2	Red	24 V DC bus	24 V DC supply for CAN interface
	3	Black	0 V bus	0 V CAN interface
	4	White	CAN_H	Received/transmitted data high
	5	Blue	CAN_L	Received/transmitted data low
Open Style bus connection				
	1	Black	0 V bus	0 V CAN interface
	2	Blue	CAN_L	Received/transmitted data low
	3	Blank	Screened	Connection to housing
	4	White	CAN_H	Received/transmitted data high
	5	Red	24 V DC bus	24 V DC supply for CAN interface
Bus connection 7/8^o				
	1	Black	Screened	Connection to housing
	2	Blue	24 V DC	24 V DC supply for CAN interface
	3	Blank	0 V	0 V CAN interface
	4	White	CAN_H	Received/transmitted data high
	5	Red	CAN_L	Received/transmitted data low

1) Typical for DeviceNet connecting cables

Terminal CPX

Accessories – Bus node CPX-FB11

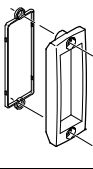
FESTO

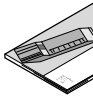
Ordering data			
Designation		Part No.	Type
Bus node			
	DeviceNet bus node	526172	CPX-FB11
Bus connection			
	Sub-D plug	532219	FBS-SUB-9-BU-2x5POL-B
	Connection block, socket Sub-D 9-pin, plug 7/8", 5-pin	571052	CPX-AB-1-7/8-DN
	Micro Style bus connection, 2xM12	525632	FBA-2-M12-5POL
	Socket for MicroStyle connection, M12	18324	FBSD-GD-9-5POL
	Plug for Micro Style connection, M12	175380	FBS-M12-5GS-PG9
	Open Style bus connection for 5-pin terminal strip	525634	FBA-1-SL-5POL
	Terminal strip for Open Style connection, 5-pin	525635	FBSD-KL-2x5POL
	Inspection cover, transparent	533334	AK-SUB-9/15-B
	Inscription label holder for connection block	536593	CPX-ST-1
	Adapter from 5-pin M12 to mini USB socket and controller software	547432	NEFC-M12G5-0.3-U1G5
User manual			
	User manual for bus node CPX-FB11	German	526421 P.BE-CPX-FB11-DE
		English	526422 P.BE-CPX-FB11-EN
		Spanish	526423 P.BE-CPX-FB11-ES
		French	526424 P.BE-CPX-FB11-FR
		Italian	526425 P.BE-CPX-FB11-IT

Terminal CPX

Technical data – Bus node CPX-FB13



Bus node for handling communication between the electrical CPX terminal and a higher-order master via PROFIBUS DP.

The bus node is provided with system supply via the interlinking block and processes communication with the I/O modules.

The status of the CPX terminal is displayed as a common message via four CPX-specific LEDs.

The fieldbus communication status is displayed via the PROFIBUS-specific error LED.



Application

Bus connection

The bus connection is established via a 9-pin Sub-D socket with a typical PROFIBUS allocation (to EN 50170).

The bus connector plug (with IP65/IP67 protection from Festo or IP20 protection from other manufacturers) facilitates the connection of an incoming and an outgoing bus cable.

An active bus terminal can be connected using the DIL switch integrated in the plug.

The Sub-D interface is designed for controlling network components with a fibre-optic cable connection.

PROFIBUS DP implementation

The CPX-FB13 supports the PROFIBUS DP protocol to EN 50170 Volume 2 for synchronous I/O exchange, parameterisation and diagnostic functions (DPV0).

In addition to DPV0, asynchronous communication to the advanced specification DPV1 is supported. DPV1 provides asynchronous access to advanced system information and assigns operation parameters while the controller is running via the user program.

An example of this is access to the integrated diagnostic memory function, i.e. storage of the last 40 errors with timestamp, module, channel and error type.

With its address capacity of 64 byte inputs and 64 byte outputs, the CPX-FB13 supports any configuration of I/O modules, including pneumatic interface.

Special points in combination with CPX-CEC

When a bus node is combined with a control block (CPX-CEC, in the fieldbus remote controller operating mode), the connected I/Os and/or valves, sensors and actuators are controlled via the CPX control block.

In this case, the bus node only provides the communication interface to the PLC. Communication between the control block and CPX bus node is established

via the interlinking of the CPX modules and occupies an address capacity of the CPX system of:

- 8 byte outputs
- 8 byte inputs

The remaining address capacity of the control block or CPX system for actuating the peripherals is:

- 56 byte inputs
- 56 byte outputs

Terminal CPX

Technical data – Bus node CPX-FB13

FESTO

General technical data			
Type		CPX-FB13	
Fieldbus interface		Sub-D socket, 9-pin (EN 50 170) Galvanically isolated 5 V	
Baud rate	[Mbit/s]	0.0096 ... 12	
Addressing range		1 ... 125 Set using DIL switch	
Product range		4: Valves	
Ident. number		0x059E	
Communication types		DPV0: Synchronous communication DPV1: Asynchronous communication	
Configuration support		GSD file and bitmaps	
Max. address capacity	Inputs	[byte]	64
	Outputs	[byte]	64
LED displays (bus-specific)		BF: Bus fault	
Device-specific diagnostics		Identifier and channel-oriented diagnostics to EN 50170 (PROFIBUS standard)	
Parameterisation		<ul style="list-style-type: none"> Start-up parameterisation via configuration interface in plain text (GSD) Asynchronous parameterisation via DPV1 	
Additional functions		<ul style="list-style-type: none"> Storage of the last 40 errors with timestamp (access via DPV1) 8-bit system status in image table for inputs 2-byte inputs and 2-byte outputs, system diagnostics in image table 	
Control elements		DIL switch	
Operating voltage	Nominal value	[V DC]	24
	Permissible range	[V DC]	18 ... 30
	Power failure buffering	[ms]	10
Current consumption		[mA]	Typically 200
Protection class to EN 60529		IP65, IP67	
Temperature range	Operation	[°C]	-5 ... +50
	Storage/transport	[°C]	-20 ... +70
Materials		PA-reinforced PC	
Grid dimension		[mm]	50
Dimensions (incl. interlinking block) W x L x H		[mm]	50 x 107 x 50
Weight		[g]	115

 Note

Please observe the general limits and guidelines for the system when configuring the electrical modules.

Terminal CPX

Technical data – Bus node CPX-FB13

Connection and display components

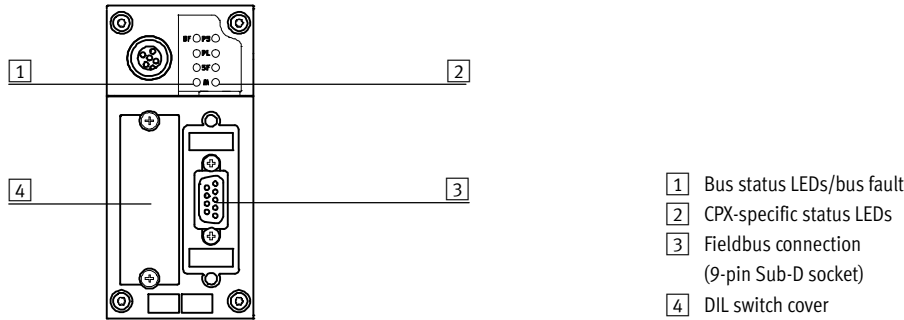

- 1 Bus status LEDs/bus fault
- 2 CPX-specific status LEDs
- 3 Fieldbus connection (9-pin Sub-D socket)
- 4 DIL switch cover

Pin allocation for PROFIBUS DP interface



Pin allocation	Pin	Signal	Designation
Sub-D socket			
	1	n.c.	Not connected
	2	n.c.	Not connected
	3	RxD/TxD-P	Received/transmitted data P
	4	CNTR-P ¹⁾	Repeater control signal
	5	DGND	Data reference potential (M5V)
	6	VP	Supply voltage (P5V)
	7	n.c.	Not connected
	8	RxD/TxD-N	Received/transmitted data N
	9	n.c.	Not connected
	Housing	Screened	Connection to housing
Bus connection M12 adapter (B-coded)			
Incoming			
	1	n.c.	Not connected
	2	RxD/TxD-N	Received/transmitted data N
	3	n.c.	Not connected
	4	RxD/TxD-P	Received/transmitted data P
	5 and M12	Screened	Connection to FE (functional earth)
Outgoing			
	1	VP	Supply voltage (P5V)
	2	RxD/TxD-N	Received/transmitted data N
	3	DGND	Data reference potential (M5V)
	4	RxD/TxD-P	Received/transmitted data P
	5 and M12	Screened	Connection to FE (functional earth)

1) The repeater control signal CNTR-P is realised as a TTL signal.

Terminal CPX

Accessories – Bus node CPX-FB13

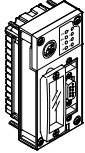
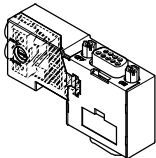
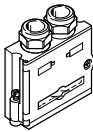
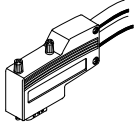

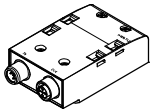
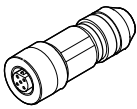
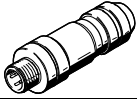
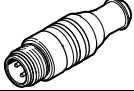
FESTO

Ordering data			
Designation		Part No.	Type
Bus node			
	PROFIBUS bus node	195740	CPX-FB13
Bus connection			
	Sub-D straight plug connector with terminating resistor and programming interface	574589	NECU-S1W9-C2-APB
	Sub-D plug, straight	532216	FBS-SUB-9-GS-DP-B
	Sub-D plug, angled	533780	FBS-SUB-9-WS-PB-K
	Bus connection M12 adapter (B-coded)	533118	FBA-2-M12-5POL-RK
	Connection block M12 adapter (B-coded)	541519	CPX-AB-2-M12-RK-DP
	Socket M12x1, 5-pin, straight, for self-assembly of a connecting cable for FBA-2-M12-5POL-RK and CPX-AB-2-M12-RK-DP	1067905	NECU-M-B12G5-C2-PB
	Plug M12x1, 5-pin, straight, for self-assembly of a connecting cable for FBA-2-M12-5POL-RK and CPX-AB-2-M12-RK-DP	1066354	NECU-M-S-B12G5-C2-PB
	Terminating resistor, M12, B-coded for PROFIBUS	1072128	CACR-S-B12G5-220-PB

Terminal CPX

Accessories – Bus node CPX-FB13

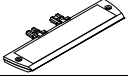
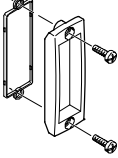
FESTO

Ordering data				
Designation		Part No.	Type	
Bus connection				
	Inscription label holder for connection block M12	536593	CPX-ST-1	
	Inspection cover, transparent	533334	AK-SUB-9/15-B	
	Adapter from 5-pin M12 to mini USB socket and controller software	547432	NEFC-M12G5-0.3-U1G5	
User manual				
	User manual for bus node CPX-FB13	German	526427	P.BE-CPX-FB13-DE
		English	526428	P.BE-CPX-FB13-EN
		Spanish	526429	P.BE-CPX-FB13-ES
		French	526430	P.BE-CPX-FB13-FR
		Italian	526431	P.BE-CPX-FB13-IT

Terminal CPX

Technical data – Bus node CPX-FB14



Bus node for handling communication between the electrical CPX terminal and a CANopen network master or CANopen network. The bus node is provided with system supply via the interlinking block and processes communication with the I/O modules. The status of the CPX terminal is displayed as a common message via four CPX-specific LEDs. The different CANopen statuses and the fieldbus communication status are displayed via three additional LEDs.



Application

Bus connection

<p>The bus connection is established via a 9-pin Sub-D plug (pin) as per the CAN in Automation (CiA) specification DS 102 with additional 24 V CAN transceiver supply (option as per DS 102).</p>	<p>The bus connector plug (with IP65/IP67 protection from Festo or IP20 protection from other manufacturers) facilitates the connection of an incoming and an outgoing bus cable.</p>	<p>There are four contacts available for the four wires (CAN_L, CAN_H, 24 V, 0 V) of the incoming and outgoing bus cables.</p>
---	---	--

CANopen implementation

<p>The CPX-FB14 supports the CANopen protocol in accordance with the specifications DS 301 V4.01 and DS 401 V2.0. Implementation is based on the CiA Pre-defined Connection Set. There are four PDOs available for fast I/O data exchange.</p>	<p>Advanced system information can also be accessed by means of SDO communication. SDO communication also facilitates parameterisation before network startup or while the controller is running via the user program. An example of this is access to the integrated diagnostic memory function, i.e. storage of the last 40 errors with timestamp, module, channel and error type.</p>	<p>With its address capacity, the CPX-FB14 supports a large number of I/O module configurations, including pneumatic interface. By default, 8 byte digital inputs and 8 byte digital outputs can be addressed via PDO 1.</p>	<p>8 analogue input channels and 8 analogue output channels can be addressed via PDO 2 and 3. Status and diagnostic information can be evaluated via PDO 4. Additional 8 byte digital inputs and outputs as well as 8 analogue input and output channels can be addressed via mapping.</p>
--	--	--	--

Special points in combination with CPX-CEC

<p>When a bus node is combined with a control block (CPX-CEC, in the fieldbus remote controller operating mode), the connected I/Os and/or valves, sensors and actuators are controlled via the CPX control block.</p>	<p>In this case, the bus node only provides the communication interface to the PLC. Communication between the control block and CPX bus node is established</p>	<p>via the interlinking of the CPX modules and occupies an address capacity of the CPX system of:</p> <ul style="list-style-type: none"> • 8 byte outputs • 8 byte inputs 	<p>The remaining address capacity of the control block or CPX system for actuating the peripherals is:</p> <ul style="list-style-type: none"> • 56 byte inputs • 56 byte outputs
--	---	---	--

Terminal CPX

Technical data – Bus node CPX-FB14

General technical data			
Type	CPX-FB14		
Fieldbus interface	Sub-D pin, 9-pin (to DS 102) Bus interface galvanically isolated via optocoupler 24 V supply for CAN interface via bus		
Baud rate	[kbit/s]	125; 250; 500 and 1,000 can be set via DIL switch	
Addressing range	Node ID 1 ... 127 Set using DIL switch		
Product range	Digital inputs and outputs		
Communication profile	DS 301, V4.01		
Device profile	DS 401, V2.0		
Number	PDO	4 Tx/4 Rx	
	SDO	1 server SDO	
Configuration support	EDS file and bitmaps		
Max. address capacity	Inputs	[byte]	16 digital, 16 analogue channels
	Outputs	[byte]	16 digital, 16 analogue channels
LED displays (bus-specific)	MS = Module status NS = Network status IO = I/O status		
Device-specific diagnostics	Via emergency message Object 1001, 1002 and 1003		
Parameterisation	Via SDO		
Additional functions	<ul style="list-style-type: none"> • Storage of the last 40 errors with timestamp (access via SDO) • 8-bit system status via transmit PDO 4 (default) • 2-byte inputs and 2-byte outputs, system diagnostics via PDO 4 • Minimum boot-up • Variable PDO mapping • Emergency message • Node guarding • Heart beat 		
Control elements	DIL switch		
Operating voltage	Nominal value	[V DC]	24
	Permissible range	[V DC]	18 ... 30
	Power failure buffering	[ms]	10
Current consumption	[mA]	Typically 200	
Protection class to EN 60529	IP65, IP67		
Temperature range	Operation	[°C]	-5 ... +50
	Storage/transport	[°C]	-20 ... +70
Materials	PA-reinforced PC		
Grid dimension	[mm]	50	
Dimensions (incl. interlinking block) W x L x H	[mm]	50 x 107 x 50	
Weight	[g]	115	

 Note

Please observe the general limits and guidelines for the system when configuring the electrical modules.

Terminal CPX

Technical data – Bus node CPX-FB14

Connection and display components

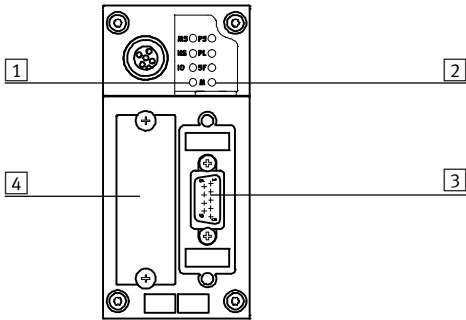

- 1 Bus-specific LEDs
- 2 CPX-specific status LEDs
- 3 Fieldbus connection (9-pin Sub-D, plug)
- 4 DIL switch cover







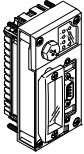
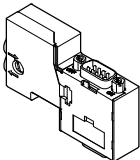

Pin allocation for the CANopen interface

Pin allocation	Pin	Signal	Designation
Sub-D plug			
	1	n.c.	Not connected
	2	CAN_L	Received/transmitted data low
	3	CAN_GND	0 V CAN interface
	4	n.c.	Not connected
	5	CAN_Shld	Optional screened connection
	6	GND	Ground ¹⁾
	7	CAN_H	Received/transmitted data high
	8	n.c.	Not connected
	9	CAN_V+	24 V DC supply for CAN interface
	Housing	Screened	Connection to FE (functional earth)
Micro Style bus connection (M12)			
Incoming			
	1	Screened	Connection to FE (functional earth)
	2	CAN_V+	24 V DC supply for CAN interface
	3	CAN_GND	0 V CAN interface
	4	CAN_H	Received/transmitted data high
	5	CAN_L	Received/transmitted data low
Outgoing			
	1	Screened	Connection to FE (functional earth)
	2	CAN_V+	24 V DC supply for CAN interface
	3	CAN_GND	0 V CAN interface
	4	CAN_H	Received/transmitted data high
	5	CAN_L	Received/transmitted data low
Open Style bus connection			
	1	CAN_GND	0 V CAN interface
	2	CAN_L	Received/transmitted data low
	3	Screened	Connection to FE (functional earth)
	4	CAN_H	Received/transmitted data high
	5	CAN_V+	24 V DC supply for CAN interface

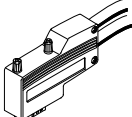
1) Connected internally via Pin 3

Terminal CPX

Accessories – Bus node CPX-FB14

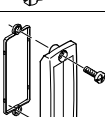
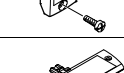
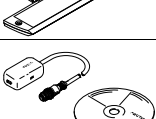
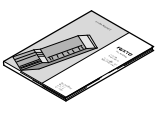
Ordering data			
Designation		Part No.	Type
Bus node			
	CANopen bus node	526174	CPX-FB14
Bus connection			
	Sub-D socket for CANopen with terminating resistor and programming interface	574588	NECU-S1W9-C2-ACO
	Sub-D plug	532219	FBS-SUB-9-BU-2x5POL-B
	Sub-D plug, angled	533783	FBS-SUB-9-WS-CO-K
	Connection block, Sub-D socket, 9-pin, plug 7/8", 5-pin	571052	CPX-AB-1-7/8-DN
	Micro Style bus connection, 2xM12, 5-pin	525632	FBA-2-M12-5POL
	Fieldbus socket for Micro Style connection, M12, 5-pin	18324	FBSD-GD-9-5POL
	Plug for Micro Style connection, M12, 5-pin	175380	FBS-M12-5GS-PG9
	Open Style bus connection	525634	FBA-1-SL-5POL
	Terminal strip for Open Style connection, 5-pin	525635	FBSD-KL-2x5POL
	Inspection cover, transparent	533334	AK-SUB-9/15-B
	Inscription label holder for connection block	536593	CPX-ST-1
	Adapter from 5-pin M12 to mini USB socket and controller software	547432	NEFC-M12G5-0.3-U1G5
User manual			
	User manual for bus node CPX-FB14	German	526409 P.BE-CPX-FB14-DE
		English	526410 P.BE-CPX-FB14-EN
		Spanish	526411 P.BE-CPX-FB14-ES
		French	526412 P.BE-CPX-FB14-FR
		Italian	526413 P.BE-CPX-FB14-IT

Terminal CPX

Technical data – Bus node CPX-M-FB21



Bus node for handling communication between the electrical terminal CPX and a higher-order master via INTERBUS.

The bus node processes communication with the I/O modules.

The status of the terminal CPX is displayed as a common message via 4 CPX-specific LEDs.

The fieldbus communication status is displayed via 6 INTERBUS-specific LEDs.



Application

Bus connection

The bus connection is established via a socket with INTERBUS Rugged Line connection technology and the associated plug, with fibre-optic cables used for the power supply to the valve terminal and data transmission.

The bus node is used as a remote I/O. It supports processing of max. 96 inputs and 96 outputs or max. 6 analogue I/O channels.

The I/O area is divided into:

- Digital I/O
- Analogue I/O

- System status/system diagnostics (optional)
- PCP channel (optional)

INTERBUS implementation

The CPX-M-FB21 support the INTERBUS protocol to EN 50254. In addition to cyclic I/O exchange, the optional PCP channel can be used for parameterisation and diagnostic functions.

An example of this is access to the integrated diagnostic memory function, i.e. storage of the last 40 errors with timestamp, module, channel and error type.

The PCP channel provides access to advanced system information and assigns operation parameters while the controller is running via the user program.

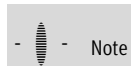

Note

If the PCP channel is used, the maximum number of possible process data bits is reduced by 16.

Special features in combination with CPX-FB21

- Remote Controller operating mode is not supported. A CPX-CEC cannot be used in combination with CPX-FB21 in a terminal CPX.

- Power is supplied via the fieldbus connection. It is therefore not possible to use an interlinking block with system supply within a terminal CPX with CPX-M-FB21.

- Only the valve terminals VTSA and VTSA-F with pneumatic interface VABA-S6-1-X2 can be selected as the pneumatic part.

Terminal CPX

Technical data – Bus node CPX-M-FB21

General technical data			
Type		CPX-M-FB21	
Fieldbus interface		Rugged Line fibre-optic cable connection	
Baud rate		[Mbit/s]	0.5 and 2
Bus type		Remote bus	
Max. address capacity	Inputs	[bit]	96
	Outputs	[bit]	96
LED displays	INTERBUS-specific		BA = Bus active FO1 = Fibre-optic cable 1 FO2 = Fibre-optic cable 2 RC = Remotebus check RD = Remotebus disable UL = Operating voltage for INTERBUS interface
	CPX-specific		M = Parameterisation SF = System fault US1 = Electronics supply, sensor supply US2 = Load supply
Device-specific diagnostics		<ul style="list-style-type: none"> • Diagnostic memory • Channel and module-oriented diagnostics • Module undervoltage 	
Parameterisation		<ul style="list-style-type: none"> • Diagnostic behaviour • Fail-safe response • Forcing of channels • Signal setup • System parameters 	
Additional functions		<ul style="list-style-type: none"> • Module and system parameterisation via operator units • System status can be represented using process data • Additional diagnostic interface for operator units 	
Operating elements		DIL switches	
Operating voltage	Nominal value	[V DC]	24 (polarity-safe)
	Permissible range	[V DC]	18 ... 30
Intrinsic current consumption at nominal operating voltage		[mA]	Typically 90
Protection class to EN 60529		IP65, IP67	
Temperature range	Operation	[°C]	-5 ... +50
	Storage/transport	[°C]	-20 ... +70
CE marking (see declaration of conformity)		To EU EMC Directive	
Housing materials		Aluminium	
Note on materials		RoHS-compliant	
Grid dimension		[mm]	50
Dimensions (incl. interlinking block) W x L x H		[mm]	100 x 110 x 130
Product weight	CPX-FB21	[g]	1,255

 Note

Please observe the general limits and guidelines for the system when configuring the electrical modules.

Terminal CPX

Technical data – Bus node CPX-M-FB21

Connection and display components

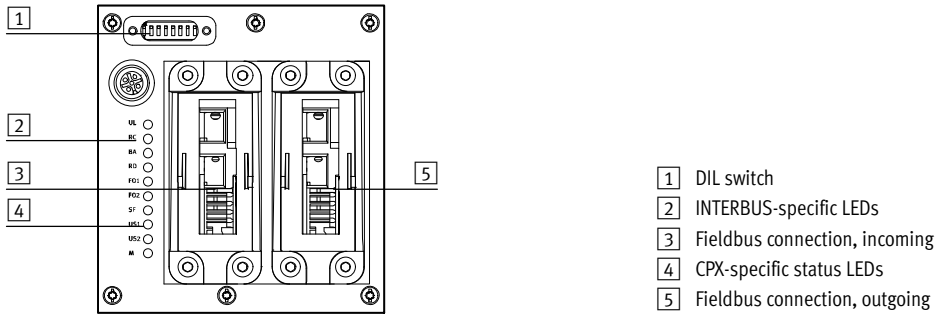



Pin allocation for INTERBUS interface

FOC pin allocation	Pin	Wire colour	Designation
Incoming			
	A	Black	Transmitted data
	B	Orange	Received data
	1	–	24 V supply for electronics and inputs
	2	–	0 V supply for electronics and inputs
	3	–	24 V supply for valves and outputs
	4	–	0 V supply for valves and outputs
5	–	Functional earth	
Outgoing			
	A	Orange	Transmitted data
	B	Black	Received data
	1	–	24 V supply for electronics and inputs
	2	–	0 V supply for electronics and inputs
	3	–	24 V supply for valves and outputs
	4	–	0 V supply for valves and outputs
5	–	Functional earth	

Terminal CPX

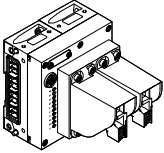
Accessories – Bus node CPX-M-FB21

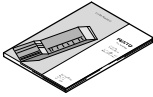
Ordering data				
Designation			Part No.	Type
Bus node				
	INTERBUS bus node, incoming and outgoing fieldbus connection		572221	CPX-M-FB21
Bus connection				
	Blanking plate for covering the DIL switches		572818	CPX-M-FB21-IB-RL
Manual				
	Manual – Bus nodes CPX-M-FB21	German	575107	P.BE-CPX-FB20/21-DE
		English	575108	P.BE-CPX-FB20/21-EN
		Spanish	575109	P.BE-CPX-FB20/21-ES
		French	575110	P.BE-CPX-FB20/21-FR
		Italian	575111	P.BE-CPX-FB20/21-IT

Terminal CPX

Technical data – Bus node CPX-FB23-24



Bus node for handling communication between the electrical CPX terminal and a higher-order master for Control & Communication-Link (CC-Link) from Mitsubishi.

The bus node is provided with system supply via the interlinking block and processes communication with the I/O modules.

The status of the CPX terminal is displayed as a common message via 4 CPX-specific LEDs.

The fieldbus communication status is displayed via 4 CC-Link-specific LEDs.



Application

Bus connection

The bus connection can be selected when ordering and is established by means of a screw terminal with IP20

protection, a Sub-D plug with IP65/IP67 protection from Festo or IP20 protection from other

manufacturers. Both connection types have the function of an integrated T-distributor and

thus support the connection of an incoming and outgoing bus cable.

CC-Link implementation

The CPX bus node CPX-FB23-24 optionally supports the CC-Link versions 2.0 (as function module F24) and 1.1 (as function module F23). These designations are also found in the system diagram for the CPX Maintenance Tool (CPX-FMT) or in the operator unit (CPX-MMI-1) from Festo.

Function module F24 corresponds to CC-Link version 2.0 and supports a maximum of four stations per slave, up to an address capacity 64 bytes of digital I/O and 64 bytes of analogue I/O each. It is possible to optimise the configuration of the addressing in terms of either cycle time or station.

Function module F23 corresponds to CC-Link version 1.1 and supports a maximum of four stations per slave, up to an address capacity 32 bytes of digital I/O and 14 bytes of analogue I/O each.

The function module and option are set using the DIL switch on the CPX bus nodes.

Points to note in connection with CPX-CEC

When a bus node is combined with a control block (CPX-CEC, in the fieldbus remote controller operating mode), the connected I/Os and/or valves, sensors and actuators are controlled via the CPX control block.

In this case, the bus node only provides the communication interface to the PLC. Communication between the control block and CPX bus node takes place by interlinking of the CPX modules and

takes up the following address capacity in the CPX system:
 • 8 byte outputs
 • 8 byte inputs
 The following address capacity

remains in the control block or CPX system for actuation of the peripherals:
 • 56 byte inputs
 • 56 byte outputs

Terminal CPX

Technical data – Bus node CPX-FB23-24

General technical data				
Type				CPX-FB23-24
Fieldbus interface				Either <ul style="list-style-type: none"> • Sub-D socket, 9-pin • Sub-D plug, for self-assembly • Screw terminal strip, IP20
Baud rates			[kbps]	156 ... 10,000
Protocol				CC-Link
Max. address capacity, inputs	FB23	RWr	[byte]	32
		Rx	[byte]	14
	FB24	RWr	[byte]	64
		Rx	[byte]	64
Max. address capacity, outputs	FB23	RWw	[byte]	32
		Ry	[byte]	14
	FB24	RWw	[byte]	64
		Ry	[byte]	64
LED displays (bus-specific)				RUN = Communication status ERROR = Communication error SD = Send data RD = Receive data
Device-specific diagnostics				<ul style="list-style-type: none"> • Diagnostic memory • Channel and module-oriented diagnostics • Module undervoltage
Parameterisation				<ul style="list-style-type: none"> • Diagnostic behaviour • Fail-safe response • Forcing of channels • Signal setup • System parameters
Additional functions				<ul style="list-style-type: none"> • System status can be displayed using process data • Additional diagnostic interface for operator units
Control elements				DIL switches
Operating voltage	Nominal value		[V DC]	24
	Permissible range		[V DC]	18 ... 30
Current consumption			[mA]	Typically 200
Protection class to EN 60529				IP65, IP67
Temperature range	Operation		[°C]	-5 ... +50
	Storage/transport		[°C]	-20 ... +70
Materials				PA reinforced, PC
Grid dimension			[mm]	50
Dimensions (incl. interlinking block) W x L x H			[mm]	50 x 107 x 50
Product weight			[g]	115

 Note

Please observe the general limits and guidelines for the system when configuring the electrical modules.

Terminal CPX

Technical data – Bus node CPX-FB23-24

Connection and display components

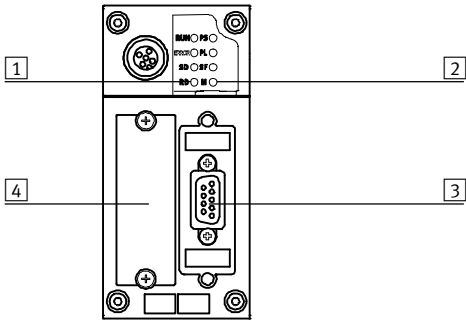





- 1 Bus-specific status LEDs
- 2 CPX-specific status LEDs
- 3 Fieldbus connection (9-pin, Sub-D socket)
- 4 DIL switch cover

Pin allocation for the CC-Link interface

Pin allocation	Pin	Signal	Designation
Sub-D socket			
	1	n.c.	Not connected
	2	DA	Data A
	3	DG	Data reference potential
	4	n.c.	Not connected
	5	FE ¹⁾	Functional earth
	6	n.c.	Not connected
	7	DB	Data B
	8	n.c.	Not connected
	9	n.c.	Not connected
Screw terminal bus connection			
	1	FG	Functional earth/housing
	2	SLD	Screening
	3	DG	Data reference potential
	4	DB	Data B
	5	DA	Data A

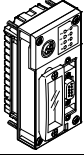
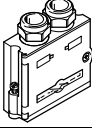
Terminal CPX

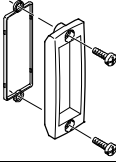
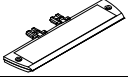
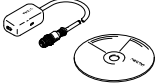
Accessories – Bus node CPX-FB23-24

Ordering data			
Description		Part No.	Type
Bus node			
	CC-Link bus node	526176	CPX-FB23-24
Bus connection			
	Sub-D plug	532220	FBS-SUB-9-GS-2x4POL-B
	Screw terminal bus connection	197962	FBA-1-KL-5POL
	Inspection cover, transparent	533334	AK-SUB-9/15-B
	Inscription label holder for connection block	536593	CPX-ST-1
	Adapter from 5-pin M12 to mini USB socket and controller software	547432	NEFC-M12G5-0.3-U1G5
User documentation			
	User documentation for bus node CPX-FB23-24	German	526403 P.BE-CPX-FB23-24-DE
		English	526404 P.BE-CPX-FB23-24-EN
		Chinese	8026069 P.BE-CPX-FB23-24-ZH

Terminal CPX

Technical data – Bus node CPX-FB33



Bus node for operating the CPX valve terminal on PROFINET.
 The bus node is provided with system supply via the interlinking block and processes communication with the I/O modules.
 The status of the CPX terminal is displayed as a common message via four CPX-specific LEDs.
 The fieldbus communication status is displayed via three bus-specific LEDs.



Application

Bus connection			
The bus connection is established via two M12 sockets, D-coded to IEC61076-2-101 with IP65, IP67 protection.	Both connections are equivalent 100BaseTX Ethernet ports with integrated auto MDI functionality	(cross-over and patch cables can be used) that are brought together via an internal switch.	<ul style="list-style-type: none"> • Maximum segment length 100 m • Transmission rate 100 Mbit/s

PROFINET implementation

The CPX-FB33 supports the PROFINET protocol on the basis of the Ethernet standard and TCP/IP technology to IEEE802.3. This guarantees a data exchange with a high data transmission rate, for example I/O data from sensors, actuators or robot controllers, PLCs	or process equipment. In addition, non-real-time critical information such as diagnostic information, configuration information, etc. can be transferred. The Ethernet bandwidth is sufficient to transfer both data types (real-time and non-real-time) in parallel.	The bus node features LEDs for bus status and CPX peripheral information as well as switch elements, memory stick and a diagnostic interface. The purpose of the memory stick is to guarantee fast replacement of the bus node in the event of an error. PROFINET provides the user with	access to all peripherals, diagnostic data and parameter data of the CPX valve terminal. The bus node can be used as a remote I/O or remote controller. All information relevant to the CPX can be read out and, depending on the function, changed via an MMI.
--	---	--	---

Special points in combination with CPX-CEC

When a bus node is combined with a control block (CPX-CEC, in the fieldbus remote controller operating mode), the connected I/Os and/or valves, sensors and actuators are controlled via the CPX control block.	In this case, the bus node only provides the communication interface to the PLC. Communication between the control block and CPX bus node is established	via the interlinking of the CPX modules and occupies an address capacity of the CPX system of: <ul style="list-style-type: none"> • 8 byte outputs • 8 byte inputs 	The remaining address capacity of the control block or CPX system for actuating the peripherals is: <ul style="list-style-type: none"> • 56 byte inputs • 56 byte outputs
---	---	--	---

Terminal CPX

Technical data – Bus node CPX-FB33

General technical data			
Type		CPX-FB33	
Fieldbus interface		2x socket M12, D-coded, 4-pin	
Baud rate		[Mbit/s]	100
Protocol		PROFINET RT PROFINET IRT	
Max. address capacity	Inputs	[byte]	64
	Outputs	[byte]	64
LED displays	(bus-specific)	M/P = Maintenance/PROFenergy NF = Network fault TP1 = Network active port 1 TP2 = Network active port 2	
	(product-specific)	M = Modify, parameterisation PL = Load supply PS = Electronic supply, sensor supply SF = System fault	
Device-specific diagnostics		<ul style="list-style-type: none"> Channel and module-oriented diagnostics Undervoltage of modules Diagnostic memory 	
Configuration support		GSDML file	
Parameterisation		<ul style="list-style-type: none"> System parameters Diagnostic behaviour Signal setup Fail-safe response Forcing of channels 	
Additional functions		<ul style="list-style-type: none"> Start-up parameterisation in plain text via fieldbus Fast startup (FSU) Channel-oriented diagnostics via fieldbus Asynchronous data access via fieldbus System status can be represented using process data Additional diagnostic interface for operator units Asynchronous data access via Ethernet 	
Control elements		<ul style="list-style-type: none"> DIL switch Optional memory card 	
Operating voltage	Nominal value	[V DC]	24
	Permissible range	[V DC]	18 ... 30
Current consumption		[mA]	Typically 120
Protection class to EN 60529		IP65, IP67	
Temperature range	Operation	[°C]	- 5... +50
	Storage/transport	[°C]	-20 ... +70
Materials		Housing	
Grid dimension		[mm]	50
Dimensions (incl. interlinking block) W x L x H		[mm]	50 x 107 x 50
Weight		[g]	280

 Note

Please observe the general limits and guidelines for the system when configuring the electrical modules.

 Note

Always use screws appropriate to the interlinking block (metal or plastic):

- Self-tapping screws for plastic interlinking blocks

- Screws with metric thread for metal interlinking blocks

Terminal CPX

Technical data – Bus node CPX-FB33

Connection and display components

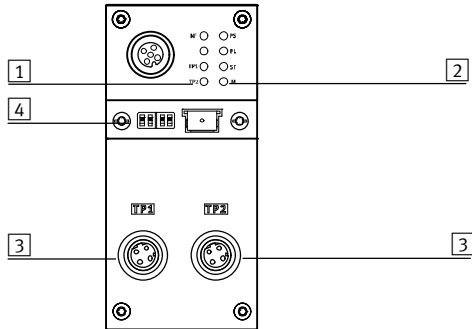

- 1 Bus-specific status LEDs
- 2 CPX-specific status LEDs
- 3 Fieldbus connection
(4-pin socket M12, D-coded)
- 4 Transparent cover for DIL switch
and memory card





Pin allocation for the fieldbus interface

Pin allocation	Pin	Signal	Designation
M12 socket, D-coded			
	1	TD+	Transmitted data+
	2	RD+	Received data+
	3	TD-	Transmitted data-
	4	RD-	Received data-
	Housing		

Terminal CPX

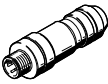
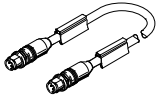
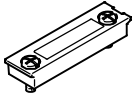
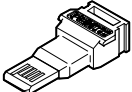
Accessories – Bus node CPX-FB33



Ordering data				
Designation			Part No.	Type
Bus node				
	PROFINET bus node		548755	CPX-FB33
Bus connection				
	Plug M12x1, 4-pin, D-coded		543109	NECU-M-S-D12G4-C2-ET
	Connecting cable, straight plug, M12x1, 4-pin, D-coded	Straight plug, M12x1, 4-pin, D-coded	0.5 m	8040446 NEBC-D12G4-ES-0.5-S-D12G4-ET
			1 m	8040447 NEBC-D12G4-ES-1-S-D12G4-ET
			3 m	8040448 NEBC-D12G4-ES-3-S-D12G4-ET
			5 m	8040449 NEBC-D12G4-ES-5-S-D12G4-ET
			10 m	8040450 NEBC-D12G4-ES-10-S-D12G4-ET
	Straight plug, RJ45, 8-pin	1 m	8040451 NEBC-D12G4-ES-1-S-R3G4-ET	
		3 m	8040452 NEBC-D12G4-ES-3-S-R3G4-ET	
		5 m	8040453 NEBC-D12G4-ES-5-S-R3G4-ET	
Open end, 4-wire	10 m	8040454 NEBC-D12G4-ES-10-S-R3G4-ET		
	5 m	8040456 NEBC-LE4-ES-5-D12G4-ET		
	Transparent cover for DIL switch and memory card		548757	CPX-AK-P
	Memory card for PROFINET bus node, 2 MB		568647	CPX-SK-2
	Cover cap for sealing unused bus connections (10 pieces)		165592	ISK-M12
	Screws for attaching an inscription label holder to the bus node (12 pieces)		550222	CPX-M-M2,5X8-12X
	Adapter from 5-pin M12 to mini USB socket and controller software		547432	NEFC-M12G5-0.3-U1G5
User manual				
	Electronics manual, CPX bus node, type CPX-FB33	German	548759	P.BE-CPX-PNIO-DE
		English	548760	P.BE-CPX-PNIO-EN
		Spanish	548761	P.BE-CPX-PNIO-ES
		French	548762	P.BE-CPX-PNIO-FR
		Italian	548763	P.BE-CPX-PNIO-IT

Terminal CPX

Technical data – Bus node CPX-M-FB34



Bus node for operating the CPX valve terminal on PROFINET.
 The bus node is provided with system supply via the interlinking block and processes communication with the I/O modules.
 The status of the CPX terminal is displayed as a common message via four CPX-specific LEDs.
 The fieldbus communication status is displayed via three bus-specific LEDs.



Application

Bus connection

The bus connection is established via two RJ45 push-pull sockets to IEC61076-3-106 and IEC60603 with IP65, IP67 protection.

Both connections are equivalent 100BaseTX Ethernet ports with integrated auto MDI functionality (cross-over and patch cables can be used) that are brought together via an internal switch.

- Maximum segment length 100 m
- Transmission rate 100 Mbit/s

PROFINET implementation

The CPX-M-FB34 supports the PROFINET protocol based on the Ethernet standard and the TCP/IP technology to IEEE802.3. This guarantees a data exchange with a high data transmission rate, for example I/O data from sensors, actuators or robot controllers, PLCs or process equipment. In addition, non-real-time critical information such as diagnostic information, configuration information, etc. can be transferred. The Ethernet bandwidth is sufficient to transmit both data types (real-time and non-real-time) in parallel.

The bus node features LEDs for bus status and CPX peripheral information as well as switch elements, memory stick and a diagnostic interface. The purpose of the memory stick is to guarantee fast replacement of the bus node in the event of an error. PROFINET provides the user with access to all peripherals, diagnostic data and parameter data of the CPX valve terminal. The bus node can be used as a remote I/O or remote controller. All information relevant to the CPX can be read out and, depending on the function, changed via an MMI.

Special points in combination with CPX-CEC

When a bus node is combined with a control block (CPX-CEC, in the fieldbus remote controller operating mode), the connected I/Os and/or valves, sensors and actuators are controlled via the CPX control block.

In this case, the bus node only provides the communication interface to the PLC. Communication between the control block and CPX bus node is established via the interlinking of the CPX modules and occupies an address capacity of the CPX system of:

- 8/16 byte outputs
- 8/16 byte inputs

The remaining address capacity of the control block or CPX system for actuating the peripherals is:

- 56/48 byte inputs
- 56/48 byte outputs

Terminal CPX

Technical data – Bus node CPX-M-FB34

General technical data			
Type		CPX-M-FB34	
Fieldbus interface		2x RJ45 push-pull socket, AIDA	
Baud rate		[Mbit/s]	100
Protocol		PROFINET RT PROFINET IRT	
Max. address capacity	Inputs	[byte]	64
	Outputs	[byte]	64
LED displays	(bus-specific)	M/P = Maintenance/PROFenergy NF = Network fault TP1 = Network active port 1 TP2 = Network active port 2	
	(product-specific)	M = Modify, parameterisation PL = Load supply PS = Electronic supply, sensor supply SF = System fault	
Device-specific diagnostics		<ul style="list-style-type: none"> Channel and module-oriented diagnostics Undervoltage of modules Diagnostic memory 	
Configuration support		GSDML file	
Parameterisation		<ul style="list-style-type: none"> System parameters Diagnostic behaviour Signal setup Fail-safe response Forcing of channels 	
Additional functions		<ul style="list-style-type: none"> Start-up parameterisation in plain text via fieldbus Fast startup (FSU) Channel-oriented diagnostics via fieldbus Asynchronous data access via fieldbus and via Ethernet System status can be represented using process data Additional diagnostic interface for operator units 	
Control elements		DIL switch, optional memory card	
Operating voltage	Nominal value	[V DC]	24
	Permissible range	[V DC]	18 ... 30
Intrinsic current consumption at nominal operating voltage		[mA]	Typically 120
Protection class to EN 60529		IP65, IP67	
Temperature range	Operation	[°C]	- 5... +50
	Storage/transport	[°C]	-20 ... +70
Material of housing		Die-cast aluminium	
Grid dimension		[mm]	50
Dimensions (incl. interlinking block) W x L x H		[mm]	50 x 107 x 80
Weight		[g]	280

 - Note

Please observe the general limits and guidelines for the system when configuring the electrical modules.

 - Note

Always use screws appropriate to the interlinking block (metal or plastic):

- Self-tapping screws for plastic interlinking blocks

- Screws with metric thread for metal interlinking blocks

Terminal CPX

Technical data – Bus node CPX-M-FB34

Connection and display components

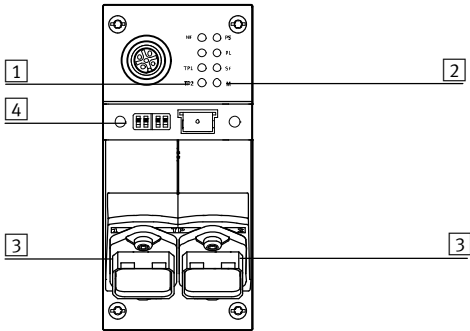



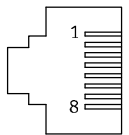

- 1 Bus-specific status LEDs
- 2 CPX-specific status LEDs
- 3 Fieldbus connection (8-pin RJ45 socket)
- 4 DIL switch and memory card

Pin allocation for the fieldbus interface

Pin allocation	Pin	Signal	Designation
RJ45 socket			
	1	TD+	Transmitted data+
	2	TD-	Transmitted data-
	3	RD+	Received data+
	4	n.c.	Not connected
	5	n.c.	Not connected
	6	RD-	Received data-
	7	n.c.	Not connected
	8	n.c.	Not connected
Housing	Screened	Screened	Screened

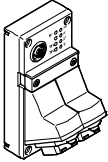
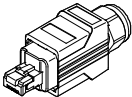
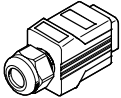
Terminal CPX

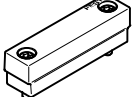
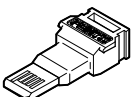
Accessories – Bus node CPX-M-FB34

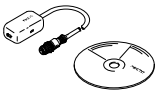
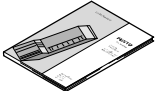
Ordering data			
Designation		Part No.	Type
Bus node			
	PROFINET bus node	548751	CPX-M-FB34
Bus connection			
	RJ45 plug, 8-pin, push-pull	552000	FBS-RJ45-PP-GS
	Cover cap for bus connection	548753	CPX-M-AK-C
	Cover cap for bus connection	2873540	CPX-M-AK-D
	Cover for DIL switch and memory card	548754	CPX-M-AK-M
	Memory card for PROFINET bus node, 2 MB	568647	CPX-SK-2
	Screws for attaching an inscription label holder to the bus node (12 pieces)	550222	CPX-M-M2,5X8-12X
	Adapter from 5-pin M12 to mini USB socket and controller software	547432	NEFC-M12G5-0.3-U1G5
User manual			
	Electronics manual, CPX bus node, type CPX-M-FB34	German	548759 P.BE-CPX-PNIO-DE
		English	548760 P.BE-CPX-PNIO-EN
		Spanish	548761 P.BE-CPX-PNIO-ES
		French	548762 P.BE-CPX-PNIO-FR
		Italian	548763 P.BE-CPX-PNIO-IT

Terminal CPX

Technical data – Bus node CPX-M-FB35/CPX-M-FB41



Bus node for operating the CPX valve terminal on PROFINET.
 The bus node is provided with system supply via the interlinking block and processes communication with the I/O modules.
 The status of the CPX terminal is displayed as a common message via 4 CPX-specific LEDs.
 The fieldbus communication status is displayed via three bus-specific LEDs.



Application

Bus connection

The bus connection is established via SCRJ push-pull sockets to IEC61754-24 (fibre-optic cable, AIDA standard) with degree of protection to IP65, IP67.

The connections on the CPX-M-FB35 are equivalent 100BaseFX Ethernet ports that are brought together via an internal switch.

Fibre-optic cables made from plastic (POF, 980/1000 µm) are also suitable for transmission.

- Maximum segment length 50 m
- Transmission rate 100 Mbps
- Supports LLDP and SNMP

PROFINET implementation

The CPX-M-FB35/CPX-M-FB41 supports the PROFINET protocol based on the Ethernet standard and TCP/IP technology to IEEE802.3. This guarantees a data exchange with a high data transmission rate, for example I/O data from sensors, actuators or robot controllers, PLCs or process equipment. Furthermore, non real-time critical information such as diagnostic information, configuration information, etc. can be transferred. The Ethernet bandwidth is sufficient to transmit both data types (real-time and non real-time) in parallel.

The bus node features LEDs for bus status and CPX peripheral information as well as switch elements, memory stick and a diagnostic interface. The purpose of the memory stick is to guarantee fast replacement of the bus node in the event of an error. PROFINET provides the user with access to all peripheral, diagnostic and parameter data for the CPX valve terminal. The bus node can be used as a remote I/O or remote controller. All information relevant to the CPX can be read out and, depending on the function, changed via an MMI.

Points to note in connection with CPX-CEC

When a bus node is combined with a control block (CPX-CEC, in the fieldbus remote controller operating mode), the connected I/Os and/or valves, sensors and actuators are controlled via the CPX control block.

In this case, the bus node only provides the communication interface to the PLC. Communication between the control block and CPX bus node takes place by interlinking the CPX modules and takes up the following address capacity in the CPX system:

- 8/16 byte outputs
- 8/16 byte inputs

The following address capacity remains in the control block or CPX system for activating the peripherals:

- 56/48 byte inputs
- 56/48 byte outputs

Terminal CPX

Technical data – Bus node CPX-M-FB35/CPX-M-FB41

General technical data			
Type		CPX-M-FB35	CPX-M-FB41
Fieldbus interface		2x SCRJ push-pull socket, AIDA	1x SCRJ push-pull socket, AIDA
Baud rate [Mbps]		100	
Protocol		PROFINET RT	PROFINET RT
		PROFINET IRT	–
Max. address capacity	Inputs [byte]	64	
	Outputs [byte]	64	
LED displays (bus-specific)		M/P = Maintenance/PROFenergy NF = Network fault TP1 = Network active port 1 TP2 = Network active port 2	NF = Network fault TP1 = Network active port 1
	(product-specific)	M = Modify, parameterisation PL = Load supply PS = Electronic supply, sensor supply SF = System fault	
Device-specific diagnostics		<ul style="list-style-type: none"> Channel and module-oriented diagnostics Undervoltage of modules Diagnostic memory 	
Configuration support		GSDML file	
Parameterisation		<ul style="list-style-type: none"> System parameters Diagnostic behaviour Signal setup Fail-safe response Forcing of channels 	
Additional functions		<ul style="list-style-type: none"> Start-up parameterisation in plain text via fieldbus Fast start-up (FSU) Channel-oriented diagnostics via fieldbus Acyclic data access via fieldbus and via Ethernet System status can be displayed using process data Additional diagnostic interface for operator unit 	
Control elements		DIL switch, optional memory card	
Operating voltage	Nominal value [V DC]	24	
	Permissible range [V DC]	18 ... 30	
Intrinsic current consumption at nominal operating voltage [mA]		Typically 150	Typically 125
Degree of protection to EN 60529		IP65, IP67	
Temperature range	Operation [°C]	– 5... +50	
	Storage/transport [°C]	–20 ... +70	
Housing material		Die-cast aluminium	
Note on materials		RoHS-compliant	
Grid dimension [mm]		50	
Dimensions (incl. interlinking block) W x L x H [mm]		50 x 107 x 80	
Product weight [g]		280	

 Note

Please observe the general limits and guidelines for the system when configuring the electrical modules.

 Note

Always use the correct screws for the interlinking block; this depends on whether the block is made of metal or polymer:

- Self-tapping screws for polymer interlinking blocks

- Screws with metric thread for metal interlinking blocks

Terminal CPX

Technical data – Bus node CPX-M-FB35/CPX-M-FB41

Connection and display components

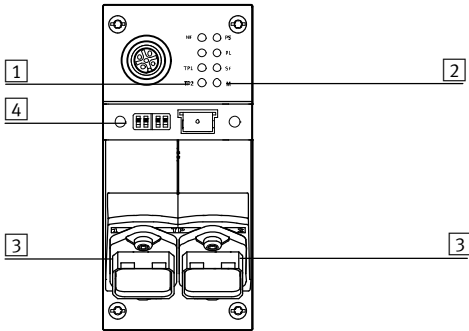





- 1 Bus-specific status LEDs
- 2 CPX-specific status LEDs
- 3 Fieldbus connection (SCRJ socket, 2-pin)
- 4 DIL switch and memory card

Pin allocation for the fieldbus interface

Terminal allocation	Pin	Signal	Designation
SCRJ socket			
	1	TX	Outgoing
	2	RX	Incoming

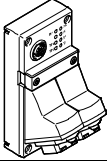
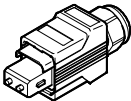
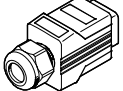
Terminal CPX

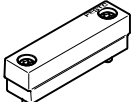
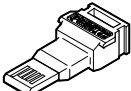
Accessories – Bus node CPX-M-FB35/CPX-M-FB41

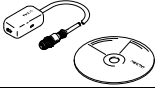
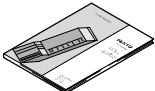
Ordering data				
Description			Part No.	Type
Bus node				
	PROFINET bus node	2x SCRJ push-pull socket, AIDA	548749	CPX-M-FB35
		1x SCRJ push-pull socket, AIDA	3228960	CPX-M-FB41
Bus connection				
	SCRJ plug, 2-pin, push-pull		571017	FBS-SCRJ-PP-GS
	Cover cap for bus connection		548753	CPX-M-AK-C
	Cover cap for bus connection		2873540	CPX-M-AK-D
	Cover for DIL switch and memory card		548754	CPX-M-AK-M
	Memory card for PROFINET bus node, 2MB		568647	CPX-SK-2
	Screws for attaching an inscription label to the bus node (12 pieces)		550222	CPX-M-M2,5X8-12X
	5-pin M12 adapter for mini USB socket and controller software		547432	NEFC-M12G5-0.3-U1G5
User documentation				
	Electronics manual, CPX bus node, type CPX-M-FB35/CPX-M-FB41	German	548759	P.BE-CPX-PNIO-DE
		English	548760	P.BE-CPX-PNIO-EN
		Spanish	548761	P.BE-CPX-PNIO-ES
		French	548762	P.BE-CPX-PNIO-FR
		Italian	548763	P.BE-CPX-PNIO-IT

Terminal CPX

Technical data – Bus node CPX-FB36



Bus node for handling communication between the electrical terminal CPX and the EtherNet/IP network.

The bus node is provided with system supply via the interlinking block and processes communication with the I/O modules.

The status of the terminal CPX is displayed as a common message via 4 CPX-specific LEDs.



Application

Bus connection
 The bus connection is established via an M12 plug, D-coded to IEC947-5-2 with IP65, IP67 protection. EtherNet/IP is an open bus system based on the Ethernet standard and TCP/IP technology (IEEE802.3).

EtherNet/IP implementation

The CPX-FB36 supports the two operating modes: remote I/O and remote controller. In remote I/O operating mode, all functions of the CPX valve terminal are directly controlled by the EtherNet/IP master (host). In addition to actuation via a bus system, it is possible to use IT technologies. An integrated web server enables diagnostic data to be visualised via HTML. Various programs support direct access to the data of the device from the automation network. The EtherNet/IP node for CPX supports the transmission technology that conforms to DIN EN 50173/CAT 5.

Points to note in connection with CPX-CEC

When combining a bus node with a control block (CPX-CEC, in fieldbus remote controller operating mode), the connected I/Os or valves, sensors and actuators are controlled via the CPX control block. In this case, the bus node only provides the communication interface to the PLC. Communication between the control block and CPX bus node takes place via interlinking of the CPX modules and takes up the following address capacity in the CPX system:
 • 8 byte outputs
 • 8 byte inputs
 The following address capacity remains in the control block or CPX system for actuation of the peripherals:
 • 56 byte inputs
 • 56 byte outputs

Terminal CPX

Technical data – Bus node CPX-FB36

General technical data			
Type	CPX-FB36		
Fieldbus interface	2x M12x1 socket, D-coded, 4-pin		
Baud rates	[Mbit/s]	10/100	
Protocol	EtherNet/IP Modbus TCP		
Max. address capacity, inputs	[byte]	64	
Max. address capacity, outputs	[byte]	64	
LED displays (bus-specific)	MS = Module status NS = Network status TP1 = Network active port 1 TP2 = Network active port 2		
Device-specific diagnostics	<ul style="list-style-type: none"> Module and channel-oriented diagnostics Module undervoltage Diagnostic memory 		
Configuration support	<ul style="list-style-type: none"> EDS file L5K export with CPX-FMT 		
Parameterisation	<ul style="list-style-type: none"> Diagnostic behaviour Fail-safe response Forcing of channels Idle mode characteristics Signal setup System parameters 		
Additional functions	<ul style="list-style-type: none"> EtherNet/IP Quickconnect Ring topology (DLR) Acyclic data access via "Explicit Message" and Ethernet Integrated switch IP addressing via DHCP, DIL switch or operator unit Channel-oriented diagnostics via fieldbus Start-up parameterisation in plain text via fieldbus System status can be represented using process data Additional diagnostic interface for operator units 		
Control elements	DIL switches		
Operating voltage	Nominal value	[V DC]	24
	Permissible range	[V DC]	18 ... 30
Current consumption (at nominal voltage, without MMI)	[mA]	Typically 100	
Protection class to EN 60529	IP65, IP67		
Temperature range	Operation	[°C]	-5 ... +50
	Storage/transport	[°C]	-20 ... +70
Materials	PA reinforced		
Note on materials	RoHS-compliant		
Grid dimension	[mm]	50	
Dimensions (incl. interlinking block) W x L x H	[mm]	50 x 107 x 50	
Product weight	[g]	125	

 Note

Please observe the general limits and guidelines for the system when configuring the electrical modules.

Terminal CPX

Technical data – Bus node CPX-FB36

Connection and display components

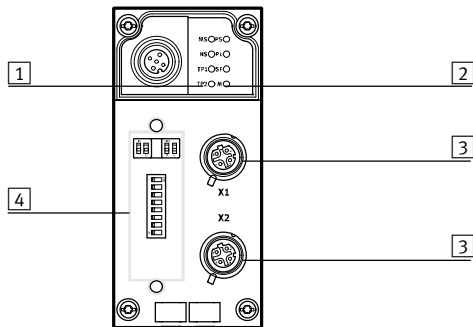

- 1 Bus-specific status LEDs
- 2 CPX-specific status LEDs
- 3 Fieldbus connection (4-pin socket M12, D-coded)
- 4 Transparent DIL switch cover



Pin allocation for the fieldbus interface

Pin allocation	Pin	Signal	Designation
M12 socket, D-coded			
	1	TD+	Transmitted data+
	2	RD+	Received data+
	3	TD-	Transmitted data-
	4	RD-	Received data-
	Housing	FE	Screening

Terminal CPX

Accessories – Bus node CPX-FB36

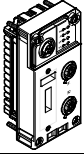
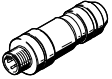
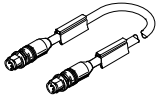
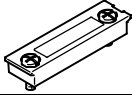
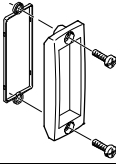
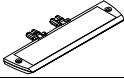
FESTO

Ordering data			
Designation		Part No.	Type
Bus node			
	EtherNet/IP bus node		1912451 CPX-FB36
Bus connection			
	Plug M12x1, 4-pin, D-coded		543109 NECU-M-S-D12G4-C2-ET
	Connecting cable, straight plug, M12x1, 4-pin, D-coded	Straight plug, M12x1, 4-pin, D-coded	0.5 m 8040446 NEBC-D12G4-ES-0.5-S-D12G4-ET
			1 m 8040447 NEBC-D12G4-ES-1-S-D12G4-ET
			3 m 8040448 NEBC-D12G4-ES-3-S-D12G4-ET
			5 m 8040449 NEBC-D12G4-ES-5-S-D12G4-ET
			10 m 8040450 NEBC-D12G4-ES-10-S-D12G4-ET
		Straight plug, RJ45, 8-pin	1 m 8040451 NEBC-D12G4-ES-1-S-R3G4-ET
			3 m 8040452 NEBC-D12G4-ES-3-S-R3G4-ET
			5 m 8040453 NEBC-D12G4-ES-5-S-R3G4-ET
			10 m 8040454 NEBC-D12G4-ES-10-S-R3G4-ET
		Open end, 4-wire	5 m 8040456 NEBC-LE4-ES-5-D12G4-ET
	Transparent cover for DIL switch and memory card		548757 CPX-AK-P
	Inspection cover, transparent		533334 AK-SUB-9/15-B
	Inscription label holder for connection block		536593 CPX-ST-1
	5-pin M12 to mini USB socket adapter and controller software		547432 NEFC-M12G5-0.3-U1G5
Manual			
	Electronics manual, CPX bus node, type CPX-FB36	German 8024074 CPX-FB36-DE	
		English 8024075 CPX-FB36-EN	
		Spanish 8024076 CPX-FB36-ES	
		French 8024077 CPX-FB36-FR	
		Italian 8024078 CPX-FB36-IT	
		Chinese 8024079 CPX-FB36-ZH	

Terminal CPX

Technical data – Bus node CPX-FB37



Bus node for operating the CPX valve terminal on EtherCAT.
 The bus node is provided with system supply via the interlinking block and processes communication with the I/O modules.
 The status of the terminal CPX is displayed as a common message via 4 CPX-specific LEDs.
 The fieldbus communication status is displayed via 4 bus-specific LEDs.



Application

Bus connection

The bus connection is established via two M12x1 sockets, D-coded to IEC61076-2-101 with degree of protection to IP65, IP67.

Both connections are equivalent 100BaseTX Ethernet ports with integrated auto MDI functionality (cross-over and patch cable can be used) that are brought together via an internal switch.

- Maximum segment length 100 m
- Transmission rate 100 Mbps

EtherCAT implementation

The CPX-FB37 supports the EtherCAT protocol based on the Ethernet standard and TCP/IP technology to IEEE802.3. This guarantees a data exchange with a high data transmission rate, for example I/O data from sensors, actuators or robot controllers, PLCs or process equipment. Furthermore, non real-time critical information such as diagnostic information, configuration information, etc. can be transferred.

The data bandwidth is sufficient to transmit both data types (real-time and non-real-time) in parallel. The bus node features LEDs for bus status and CPX peripheral information as well as switch elements and a diagnostic interface. The bus node can be used as a remote I/O or remote controller. All information relevant to the CPX can be read out and, dependent on the function, changed via an MMI/FMT.

The functions MDP (modular device profile) and CoE (CAN over EtherCAT) enable easy access to parameters and diagnostic data via EtherCAT.

Specific EtherCAT functions:

- CoE (parameters and diagnostics or fail-safe mode): all module parameters can be set
- FoE (file over EtherCAT) makes it possible to download firmware easily
- EoE (Ethernet over EtherCAT): diagnostic data can be retrieved easily using a browser
- MDP (modular device profile): easy configuration using a module selection box
- Hot Connect, easy replacement of an EtherCAT CPX terminal
- DC (distributed clocks), time-synchronised data transmission

Points to note in connection with CPX-CEC

When a bus node is combined with a control block (CPX-CEC, in the fieldbus remote controller operating mode), the connected I/Os and/or valves, sensors and actuators are controlled via the CPX control block.

In this case, the bus node only provides the communication interface to the PLC. Communication between the control block and CPX bus node takes place by interlinking the CPX modules and takes up the following address capacity in the CPX system:

- 8/16 byte outputs
- 8/16 byte inputs

The following address capacity remains in the control block or CPX system for activating the peripherals:

- 56/48 byte inputs
- 56/48 byte outputs

Terminal CPX

Technical data - Bus node CPX-FB37

General technical data			
Type		CPX-FB37	
Fieldbus interface		2x M12x1 socket, 4-pin, D-coded	
Baud rates		[Mbps]	100
Protocol		EtherCAT	
Max. address capacity	Inputs	[byte]	64
	Outputs	[byte]	64
LED displays	Bus-specific		Error = Communication error L/A1 = Network active port 1 L/A2 = Network active port 2 Run = Communication status
	Product-specific		M = Modify, parameterisation PL = Load supply PS = Electronic supply, sensor supply SF = System fault
Device-specific diagnostics		<ul style="list-style-type: none"> Channel and module-oriented diagnostics Undervoltage of modules Diagnostic memory 	
Configuration support		ESI file	
Parameterisation		<ul style="list-style-type: none"> System parameters Diagnostic behaviour Signal setup Fail-safe response Forcing of channels 	
Additional functions		<ul style="list-style-type: none"> System status can be displayed using process data Additional diagnostic interface for operator units Emergency message Acyclic data access via fieldbus Diagnostic object Compatibility mode for the CPX-FB38 Modular device profile (MDP) Variable PDO mapping 	
Control elements		DIL switches	
Operating voltage	Nominal value	[V DC]	24
	Permissible range	[V DC]	18 ... 30
Current consumption		[mA]	Typically 100
Degree of protection to EN 60529		IP65, IP67	
Temperature range	Operation	[°C]	-5 ... +50
	Storage/transport	[°C]	-20 ... +70
Materials	Housing		Reinforced PA
Note on materials		RoHS-compliant	
Grid dimension		[mm]	50
Dimensions (incl. interlinking block) W x L x H		[mm]	50 x 107 x 50
Product weight		[g]	125

 Note
Please observe the general limits and guidelines for the system when configuring the electrical modules.

 Note
Always use the correct screws for the interlinking block; this depends on whether the block is made of metal or polymer:

- Self-tapping screws for polymer interlinking blocks
- Screws with metric thread for metal interlinking blocks

Terminal CPX

Technical data – Bus node CPX-FB37

Connection and display components

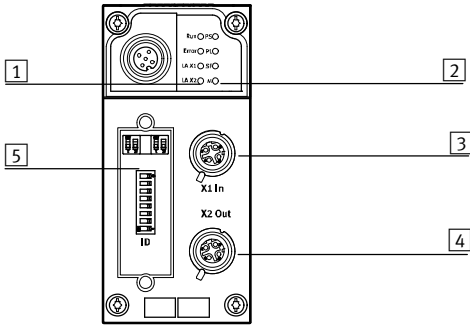

- 1 Bus-specific status LEDs
- 2 CPX-specific status LEDs
- 3 Fieldbus connection, input (M12x1 socket, 4-pin, D-coded)
- 4 Fieldbus connection, output (M12x1 socket, 4-pin, D-coded)
- 5 DIL switch





Pin allocation for the fieldbus interface

Terminal allocation	Pin	Signal	Designation
M12x1 socket, D-coded			
	1	TD+	Transmitted data+
	2	RD+	Received data+
	3	TD-	Transmitted data-
	4	RD-	Received data-
	Housing	FE	Screening

Terminal CPX

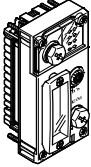
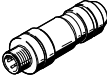
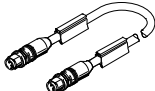
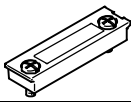
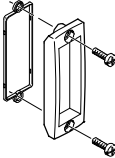
Accessories – Bus node CPX-FB37

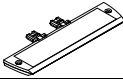
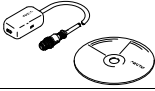
FESTO

Ordering data					
Description			Part No.	Type	
Bus node					
	EtherCAT bus node		2735960	CPX-FB37	
Bus connection					
	Plug connector M12x1, 4-pin, D-coded		543109	NECU-M-S-D12G4-C2-ET	
	Connecting cable, straight plug, M12x1, 4-pin, D-coded	Straight plug, M12x1, 4-pin, D-coded	0.5 m	8040446 NEBC-D12G4-ES-0.5-S-D12G4-ET	
			1 m	8040447 NEBC-D12G4-ES-1-S-D12G4-ET	
			3 m	8040448 NEBC-D12G4-ES-3-S-D12G4-ET	
			5 m	8040449 NEBC-D12G4-ES-5-S-D12G4-ET	
			10 m	8040450 NEBC-D12G4-ES-10-S-D12G4-ET	
			Straight plug, RJ45, 8-pin	1 m	8040451 NEBC-D12G4-ES-1-S-R3G4-ET
				3 m	8040452 NEBC-D12G4-ES-3-S-R3G4-ET
				5 m	8040453 NEBC-D12G4-ES-5-S-R3G4-ET
			Open end, 4-wire	5 m	8040454 NEBC-D12G4-ES-10-S-R3G4-ET
	Transparent cover for DIL switch and memory card		548757	CPX-AK-P	
	Inspection cover, transparent		533334	AK-SUB-9/15-B	
	Cover cap for sealing unused bus connections (10 pieces)		165592	ISK-M12	
	Inscription label holder for connection block		536593	CPX-ST-1	
	5-pin M12 adapter for mini USB socket and controller software		547432	NEFC-M12G5-0.3-U1G5	
User documentation					
	Electronics manual, CPX bus node, type CPX-FB37	German	8029674	P.BE-CPX-FB37-DE	
		English	8029675	P.BE-CPX-FB37-EN	
		Spanish	8029676	P.BE-CPX-FB37-ES	
		French	8029677	P.BE-CPX-FB37-FR	
		Italian	8029678	P.BE-CPX-FB37-IT	
		Chinese	8029679	P.BE-CPX-FB37-ZH	

Terminal CPX

Technical data – Bus node CPX-FB38



Bus node for operating the CPX valve terminal on EtherCAT. The bus node is provided with system supply via the interlinking block and processes communication with the I/O modules. The status of the CPX terminal is displayed as a common message via four CPX-specific LEDs. The fieldbus communication status is displayed via four bus-specific LEDs.



Application

Bus connection

The bus connection is established via two M12 sockets, D-coded to IEC61076-2-101 with IP65, IP67 protection.

Both connections are equivalent 100BaseTX Ethernet ports with integrated auto MDI functionality (cross-over and patch cables can be used) that are brought together via an internal switch.

- Maximum segment length 100 m
- Transmission rate 100 Mbit/s

EtherCAT implementation

The CPX-FB38 supports the EtherCAT protocol based on the Ethernet standard and the TCP/IP technology to IEEE802.3. This guarantees a data exchange with a high data transmission rate, for example I/O data from sensors, actuators or robot controllers, PLCs or process equipment. In addition, non-real-time critical information such as diagnostic information, configuration information, etc. can be transferred.

The data bandwidth is sufficient to transmit both data types (real-time and non-real-time) in parallel.

The bus node features LEDs for bus status and CPX peripheral information as well as switch elements and a diagnostic interface. The bus node can be used as a remote I/O or remote controller. All information relevant to the CPX can be read out and, dependent on the function, changed via an MMI/FMT.

Special points in combination with CPX-CEC

When a bus node is combined with a control block (CPX-CEC, in the fieldbus remote controller operating mode), the connected I/Os and/or valves, sensors and actuators are controlled via the CPX control block.

In this case, the bus node only provides the communication interface to the PLC. Communication between the control block and CPX bus node is established via the interlinking of the CPX modules and occupies an address capacity of the CPX system of:

- 8 byte outputs
- 8 byte inputs

The remaining address capacity of the control block or CPX system for actuating the peripherals is:

- 56 byte inputs
- 56 byte outputs

Terminal CPX

Technical data – Bus node CPX-FB38

General technical data			
Type	CPX-FB38		
Fieldbus interface	2x M12x1 socket, 4-pin, D-coded		
Baud rate	[Mbit/s]	100	
Max. address capacity, inputs	[byte]	64	
Max. address capacity, outputs	[byte]	64	
LED displays	(bus-specific)	Error = Communication error L/A1 = Network active port 1 L/A2 = Network active port 2 Run = Communication status	
	(product-specific)	M = Modify, parameterisation PL = Load supply PS = Electronic supply, sensor supply SF = System fault	
Device-specific diagnostics	<ul style="list-style-type: none"> • Channel and module-oriented diagnostics • Undervoltage of modules • Diagnostic memory 		
Configuration support	XML file		
Parameterisation	<ul style="list-style-type: none"> • System parameters • Diagnostic behaviour • Signal setup • Fail-safe response • Forcing of channels 		
Additional functions	<ul style="list-style-type: none"> • System status can be represented using process data • Additional diagnostic interface for operator units 		
Control elements	DIL switch		
Operating voltage	Nominal value	[V DC]	24
	Permissible range	[V DC]	18 ... 30
	Power failure buffering	[ms]	10
Current consumption			[mA] Typically 100
Protection class to EN 60529	IP65, IP67		
Temperature range	Operation	[°C]	-5 ... +50
	Storage/transport	[°C]	-20 ... +70
Materials	Housing		Reinforced PA
Grid dimension			[mm] 50
Dimensions (incl. interlinking block) W x L x H			[mm] 50 x 107 x 50
Weight			[g] 125

 Note

Please observe the general limits and guidelines for the system when configuring the electrical modules.

 Note

Always use screws appropriate to the interlinking block (metal or plastic):

- Self-tapping screws for plastic interlinking blocks

- Screws with metric thread for metal interlinking blocks

Terminal CPX

Technical data – Bus node CPX-FB38

Connection and display components

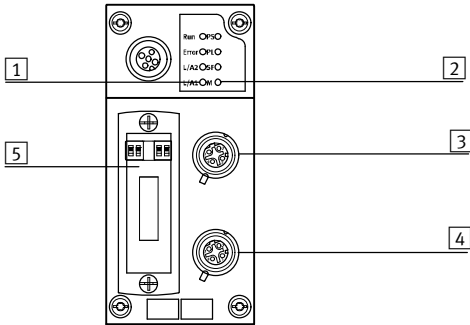

- 1 Bus-specific status LEDs
- 2 CPX-specific status LEDs
- 3 Fieldbus connection, output
(4-pin socket M12x1, D-coded)
- 4 Fieldbus connection, input
(4-pin socket M12x1, D-coded)
- 5 Transparent DIL switch cover





Pin allocation for the fieldbus interface

Pin allocation	Pin	Signal	Designation
M12x1 socket, D-coded			
	1	TD+	Transmitted data+
	2	RD+	Received data+
	3	TD-	Transmitted data-
	4	RD-	Received data-
	Housing		

Terminal CPX

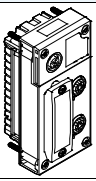
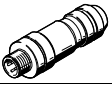
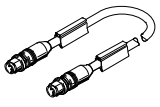
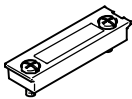
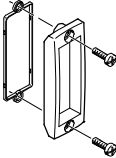
Accessories – Bus node CPX-FB38

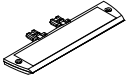
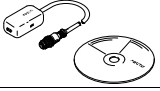
FESTO

Ordering data				
Designation			Part No.	Type
Bus node				
	EtherCAT bus node		552046	CPX-FB38
Bus connection				
	M12x1 plug, 4-pin, D-coded		543109	NECU-M-S-D12G4-C2-ET
	Connecting cable, straight plug, M12x1, 4-pin, D-coded	Straight plug, M12x1, 4-pin, D-coded	0.5 m	8040446 NEBC-D12G4-ES-0.5-S-D12G4-ET
			1 m	8040447 NEBC-D12G4-ES-1-S-D12G4-ET
			3 m	8040448 NEBC-D12G4-ES-3-S-D12G4-ET
			5 m	8040449 NEBC-D12G4-ES-5-S-D12G4-ET
			10 m	8040450 NEBC-D12G4-ES-10-S-D12G4-ET
	Straight plug, RJ45, 8-pin	1 m	8040451 NEBC-D12G4-ES-1-S-R3G4-ET	
		3 m	8040452 NEBC-D12G4-ES-3-S-R3G4-ET	
5 m		8040453 NEBC-D12G4-ES-5-S-R3G4-ET		
Open end, 4-wire	10 m	8040454 NEBC-D12G4-ES-10-S-R3G4-ET		
	5 m	8040456 NEBC-LE4-ES-5-D12G4-ET		
	Transparent cover for DIL switch and memory card		548757	CPX-AK-P
	Inspection cover, transparent		533334	AK-SUB-9/15-B
	Cover cap for sealing unused bus connections (10 pieces)		165592	ISK-M12
	Inscription label holder for connection block		536593	CPX-ST-1
	Adapter from 5-pin M12 to mini USB socket and controller software		547432	NEFC-M12G5-0.3-U1G5
User manual				
	Electronics manual, CPX bus node, type CPX-FB38	German	562524	P.BE-CPX-FB38-DE
		English	562525	P.BE-CPX-FB38-EN
		Spanish	562526	P.BE-CPX-FB38-ES
		French	562527	P.BE-CPX-FB38-FR
		Italian	562528	P.BE-CPX-FB38-IT

Terminal CPX

Technical data – Bus node CPX-FB39



IT services:



Bus node for handling communication between the electrical CPX terminal and the Sercos III network.

The bus node is provided with system supply via the interlinking block and processes communication with the I/O modules.

The status of the CPX terminal is displayed as a common message via 4 CPX-specific LEDs.



Application
Bus connection

<p>The bus connection is established via two M12x1 plug connectors, D-coded to IEC947-5-2 with degree of protection to IP65, IP67. The connections are equipped with automatic detection for the incoming and outgoing connection.</p>	<p>The Sercos III bus node can be used to connect the CPX valve terminal to the standardised Sercos III bus. Sercos II uses the Ethernet standard (IEEE802.3) and TCP/IP technology for communication in an industrial</p>	<p>environment. Industry-compatible Sercos III devices enable data to be exchanged with a higher data transmission rate, such as data from sensors, actuators or controllers. You can also transmit</p>	<p>information that is not real-time critical, such as diagnostics or configuration information.</p>
--	--	---	--

Web servers

<p>In addition to activation via a bus system, it is possible to use IT</p>	<p>technologies. An integrated web server enables diagnostic data to be</p>	<p>visualised via HTML. Various programs support direct access to the device</p>	<p>data from the automation network.</p>
---	---	--	--

Points to note in connection with CPX-CEC

<p>The CPX-FB39 supports the operating modes remote I/O and remote controller. In remote I/O operating mode, all functions of the CPX valve terminal are directly controlled by the Sercos controller.</p>	<p>When a bus node is combined with a control block (CPX-CEC, in the fieldbus remote controller operating mode), the connected I/Os and/or valves, sensors and actuators are controlled via the CPX control block. In this case, the bus node only</p>	<p>provides the communication interface to the PLC. Communication between the control block and CPX bus node takes place by interlinking the CPX modules and takes up the following address capacity in the CPX system:</p>	<ul style="list-style-type: none"> • 8/16 byte outputs • 8/16 byte inputs <p>The following address capacity remains in the control block or CPX system for activating the peripherals:</p> <ul style="list-style-type: none"> • 56/48 byte inputs • 56/48 byte outputs
--	--	---	--

Terminal CPX

Technical data – Bus node CPX-FB39

General technical data			
Type		CPX-FB39	
Fieldbus interface		2x M12x1 socket, D-coded, 4-pin	
Baud rates		[Mbps]	100 full/half duplex
Protocol		Sercos III	
Max. address capacity	Inputs	[byte]	64
	Outputs	[byte]	64
LED displays	Bus-specific		S = Sercos LED SD = Sercos sub-device LED TP1 = Network active port 1 TP2 = Network active port 2
	Product-specific		M = Modify, parameterisation PL = Load supply PS = Electronics supply, sensor supply SF = System fault
Device-specific diagnostics		<ul style="list-style-type: none"> Module and channel-oriented diagnostics Undervoltage of modules Diagnostic memory 	
Configuration support		SDDML file	
Parameterisation		<ul style="list-style-type: none"> Diagnostic behaviour Fallback output data Forcing of channels Signal setup System parameters 	
Additional functions		<ul style="list-style-type: none"> Acyclic and cyclic data access via Sercos IP addressing via Sercos parameters or operator unit Channel-oriented diagnostics via fieldbus Start-up parameterisation in plain text via fieldbus System status can be displayed using process data Additional diagnostic interface for operator units 	
Control elements		DIL switches	
Operating voltage	Nominal value	[V DC]	24
	Permissible range	[V DC]	18 ... 30
Current consumption (at nominal voltage, without MMI)		[mA]	Typically 100
Degree of protection to EN 60529		IP65, IP67	
Temperature range	Operation	[°C]	- 5 ... +50
	Storage/transport	[°C]	-20 ... +70
Materials		PA reinforced	
Note on materials		RoHS compliant	
Grid dimension		[mm]	50
Dimensions (incl. interlinking block) W x L x H		[mm]	50 x 107 x 50
Product weight		[g]	125

 - Note

Please observe the general limits and guidelines for the system when configuring the electrical modules.

Terminal CPX

Technical data – Bus node CPX-FB39

Connection and display components

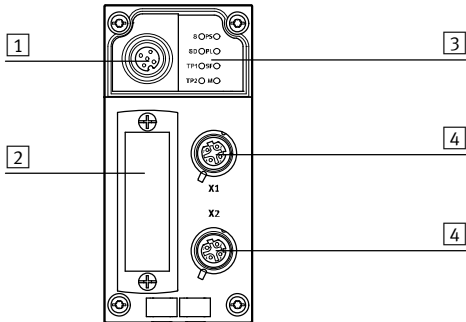

- 1 Service interface for operator unit
CPX-MMI or PC with CPX
maintenance tool
NEFC-M12G5-0.3-U1G5
- 2 Transparent DIL switch cover
- 3 Status LED, bus-specific and
CPX-specific
- 4 Fieldbus connection (M12x1
socket, 4-pin, D-coded)





Pin allocation for the fieldbus interface

Terminal allocation	Pin	Signal	Designation	
M12x1 socket, D-coded				
	1	TD+	Transmitted data+	Note The CPX-FB39 has the capability for auto- matic detection of transmit and receive cables (Auto-MDI/MDI-X Auto-Crossover). RD and TD signal pairs are automatically swapped if required.
	2	RD+	Received data+	
	3	TD-	Transmitted data-	
	4	RD-	Received data-	
	Hous- ing	FE	Screening	

Terminal CPX

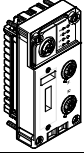
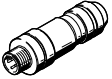
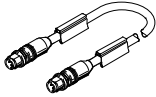
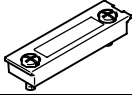
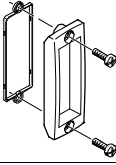
Accessories – Bus node CPX-FB39

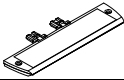
FESTO

Ordering data					
Description		Part No.	Type		
Bus node					
	Ethernet Sercos III bus node	2093101	CPX-FB39		
Bus connection					
	Plug connector M12x1, 4-pin, D-coded	543109	NECU-M-S-D12G4-C2-ET		
	Connecting cable, straight plug, M12x1, 4-pin, D-coded	Straight plug, M12x1, 4-pin, D-coded	0.5 m	8040446	NEBC-D12G4-ES-0.5-S-D12G4-ET
			1 m	8040447	NEBC-D12G4-ES-1-S-D12G4-ET
			3 m	8040448	NEBC-D12G4-ES-3-S-D12G4-ET
			5 m	8040449	NEBC-D12G4-ES-5-S-D12G4-ET
			10 m	8040450	NEBC-D12G4-ES-10-S-D12G4-ET
		Straight plug, RJ45, 8-pin	1 m	8040451	NEBC-D12G4-ES-1-S-R3G4-ET
			3 m	8040452	NEBC-D12G4-ES-3-S-R3G4-ET
			5 m	8040453	NEBC-D12G4-ES-5-S-R3G4-ET
			10 m	8040454	NEBC-D12G4-ES-10-S-R3G4-ET
Open end, 4-wire	5 m	8040456	NEBC-LE4-ES-5-D12G4-ET		
	Transparent cover for DIL switch and memory card	548757	CPX-AK-P		
	Inspection cover, transparent	533334	AK-SUB-9/15-B		
	Cover cap for sealing unused bus connections (10 pieces)	165592	ISK-M12		
	Inscription label holder for connection block	536593	CPX-ST-1		
	5-pin M12 to mini USB socket adapter and controller software	547432	NEFC-M12G5-0.3-U1G5		
User Documentation					
	User Documentation for bus node CPX-FB39	German	8028632	P.BE-CPX-FB39-DE	
		English	8028633	P.BE-CPX-FB39-EN	
		Spanish	8028634	P.BE-CPX-FB39-ES	
		French	8028635	P.BE-CPX-FB39-FR	
		Italian	8028636	P.BE-CPX-FB39-IT	
		Chinese	8028637	P.BE-CPX-FB39-ZH	

Terminal CPX

Technical data – Bus node CPX-FB40

← Ethernet POWERLINK →

IT services:

← Web →

Bus node for handling communication between the electrical CPX terminal and the Ethernet POWERLINK network. The bus node is provided with system supply via the interlinking block and processes communication with the I/O modules. The status of the CPX terminal is displayed as a common message via 4 CPX-specific LEDs.



Application

Bus connection			
The bus connection is established via an M12x1 plug connector, D-coded to IEC947-5-2 with degree of protection to IP65, IP67.	Ethernet POWERLINK uses the Ethernet standards and TCP/IP technology (IEEE802.3) for communication in an industrial environment and integrates all CANopen mechanisms. It includes all the key features of standard Ethernet, including	internode communication, hotplug capability and free selection of network topology. Ethernet POWERLINK fulfils the real-time requirements using a mix of timeslot and polling procedures. In other words, defined times are	reserved on the Ethernet lines exclusively for transferring real-time data. Only network participants which have previously been polled by the controller are able to transmit data during these timeslots.

Ethernet POWERLINK implementation			
The CPX-FB40 supports the two operating modes: remote I/O and remote controller. In remote I/O operating mode, all functions of the CPX valve terminal are	directly controlled by the Ethernet POWERLINK master (host). In addition to activation via a bus system, it is possible to use IT technologies. An integrated web server enables	diagnostic data to be visualised via HTML. Various programs support direct access to the device data from the automation network.	The Ethernet POWERLINK node for CPX supports the transmission technology that conforms to DIN EN 50173/CAT 5 as an integrated interface.

Points to note in connection with CPX-CEC			
When a bus node is combined with a control block (CPX-CEC, in the fieldbus remote controller operating mode), the connected I/Os and/or valves, sensors and actuators are controlled via the CPX control block.	In this case, the bus node only provides the communication interface to the PLC. Communication between the control block and CPX bus node takes place by	interlinking the CPX modules and takes up the following address capacity in the CPX system: <ul style="list-style-type: none"> • 8 byte outputs • 8 byte inputs 	The following address capacity remains in the control block or CPX system for activating the peripherals: <ul style="list-style-type: none"> • 56 byte inputs • 56 byte outputs

Terminal CPX

Technical data – Bus node CPX-FB40

General technical data			
Type		CPX-FB40	
Fieldbus interface		2x M12x1 socket, D-coded, 4-pin	
Baud rates		[Mbps]	100
Protocol		Ethernet POWERLINK V2	
Max. address capacity	Inputs	[byte]	64
	Outputs	[byte]	64
LED displays	Bus-specific		BE = POWERLINK error BS = POWERLINK status L/A1 = Link/activity port 1 L/A2 = Link/activity port 2
	Product-specific		M = Modify, parameterisation PL = Load supply PS = Electronic supply, sensor supply SF = System fault
Device-specific diagnostics		<ul style="list-style-type: none"> Module and channel-oriented diagnostics Undervoltage of modules Diagnostic memory 	
Configuration support		<ul style="list-style-type: none"> XDC file XDD file 	
Parameterisation		<ul style="list-style-type: none"> Diagnostic behaviour Fail-safe response Forcing of channels Signal setup System parameters 	
Additional functions		<ul style="list-style-type: none"> Acyclic data access via "SDO" and Ethernet Integrated hub IP addressing via DHCP, DIL switch or operator unit Channel-oriented diagnostics via fieldbus Start-up parameterisation in plain text via fieldbus System status can be displayed using process data Additional diagnostic interface for operator units 	
Control elements		DIL switches	
Operating voltage	Nominal value	[V DC]	24
	Permissible range	[V DC]	18 ... 30
	Protection against incorrect polarity		For operating voltage
Current consumption (at nominal voltage, without MMI)		[mA]	Typically 100
Degree of protection to EN 60529		IP65, IP67	
Temperature range	Operation	[°C]	-5 ... +50
	Storage/transport	[°C]	-20 ... +70
Materials		PA reinforced	
Note on materials		RoHS-compliant	
Grid dimension		[mm]	50
Dimensions (incl. interlinking block) W x L x H		[mm]	50 x 107 x 50
Product weight		[g]	125

 Note

Please observe the general limits and guidelines for the system when configuring the electrical modules.

Terminal CPX

Technical data – Bus node CPX-FB40

Connection and display components

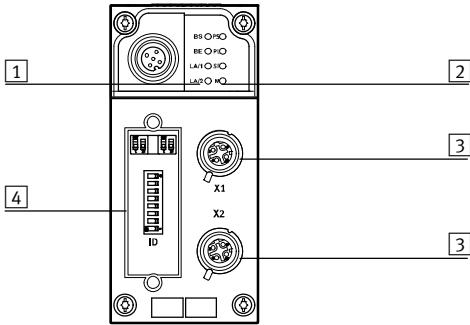

- 1 Bus-specific status LEDs
- 2 CPX-specific status LEDs
- 3 Fieldbus connection (M12x1 socket, 4-pin, D-coded)
- 4 Transparent DIL switch cover



Pin allocation for the fieldbus interface

Terminal allocation	Pin	Signal	Designation
M12x1 socket, D-coded			
	1	TD+	Transmitted data+
	2	RD+	Received data+
	3	TD-	Transmitted data-
	4	RD-	Received data-
	Housing	FE	Screening

Terminal CPX

Accessories – Bus node CPX-FB40

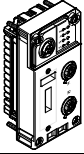
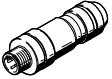
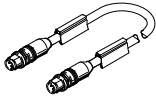
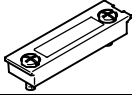
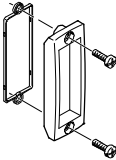
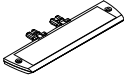

Ordering data					
Description		Part No.	Type		
Bus node					
	Ethernet POWERLINK bus node	2474896	CPX-FB40		
Bus connection					
	M12x1 plug connector, 4-pin, D-coded	543109	NECU-M-S-D12G4-C2-ET		
	Connecting cable, straight plug, M12x1, 4-pin, D-coded	Straight plug, M12x1, 4-pin, D-coded	0.5 m	8040446	NEBC-D12G4-ES-0.5-S-D12G4-ET
			1 m	8040447	NEBC-D12G4-ES-1-S-D12G4-ET
			3 m	8040448	NEBC-D12G4-ES-3-S-D12G4-ET
			5 m	8040449	NEBC-D12G4-ES-5-S-D12G4-ET
			10 m	8040450	NEBC-D12G4-ES-10-S-D12G4-ET
		Straight plug, RJ45, 8-pin	1 m	8040451	NEBC-D12G4-ES-1-S-R3G4-ET
			3 m	8040452	NEBC-D12G4-ES-3-S-R3G4-ET
			5 m	8040453	NEBC-D12G4-ES-5-S-R3G4-ET
			10 m	8040454	NEBC-D12G4-ES-10-S-R3G4-ET
		Open end, 4-wire	5 m	8040456	NEBC-LE4-ES-5-D12G4-ET
	Transparent cover for DIL switch and memory card	548757	CPX-AK-P		
	Inspection cover, transparent	533334	AK-SUB-9/15-B		
	Inscription label holder for connection block	536593	CPX-ST-1		
	5-pin M12 adapter for mini USB socket and controller software	547432	NEFC-M12G5-0.3-U1G5		
User documentation					
	User documentation for bus node CPX-FB40	German	8028650	P.BE-CPX-FB40-DE	
		English	8028651	P.BE-CPX-FB40-EN	
		Spanish	8028652	P.BE-CPX-FB40-ES	
		French	8028653	P.BE-CPX-FB40-FR	
		Italian	8028654	P.BE-CPX-FB40-IT	
		Chinese	8028655	P.BE-CPX-FB40-ZH	

Terminal CPX

Technical data – CPX-CP interface

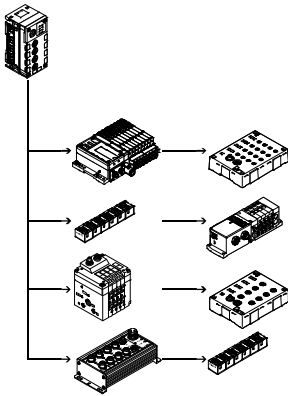

The CPX-CP electrical interface establishes the connection to CP modules of the CPI installation system via prefabricated connecting cables. The I/O data of the connected valve terminals with CP string extension and CP input and output modules are transferred to the connected CPX bus node and thus via fieldbus to the higher-order controller. This enables modular centralised and compact decentralised concepts to be established with one system.



Application

CP connection

As well as transmitting the communication data, the max. four CP strings of a CPX-CP interface also transmit the supply voltage to the connected sensors and the load supply to the valves (or outputs). Both circuits are

supplied separately with 24 V, but with a common reference potential. The valve terminals with CP string extension (or outputs) are supplied with voltage for the electronics and valves by the interlinking block.

The following combinations are made possible by the CP interface:

- Centralised analogue and digital inputs and outputs of the CPX terminal

- Decentralised digital inputs and outputs of the CP installation system
- Valve/valve terminals that can be connected both centrally and decentrally

Configuration example – CP interface with CP modules

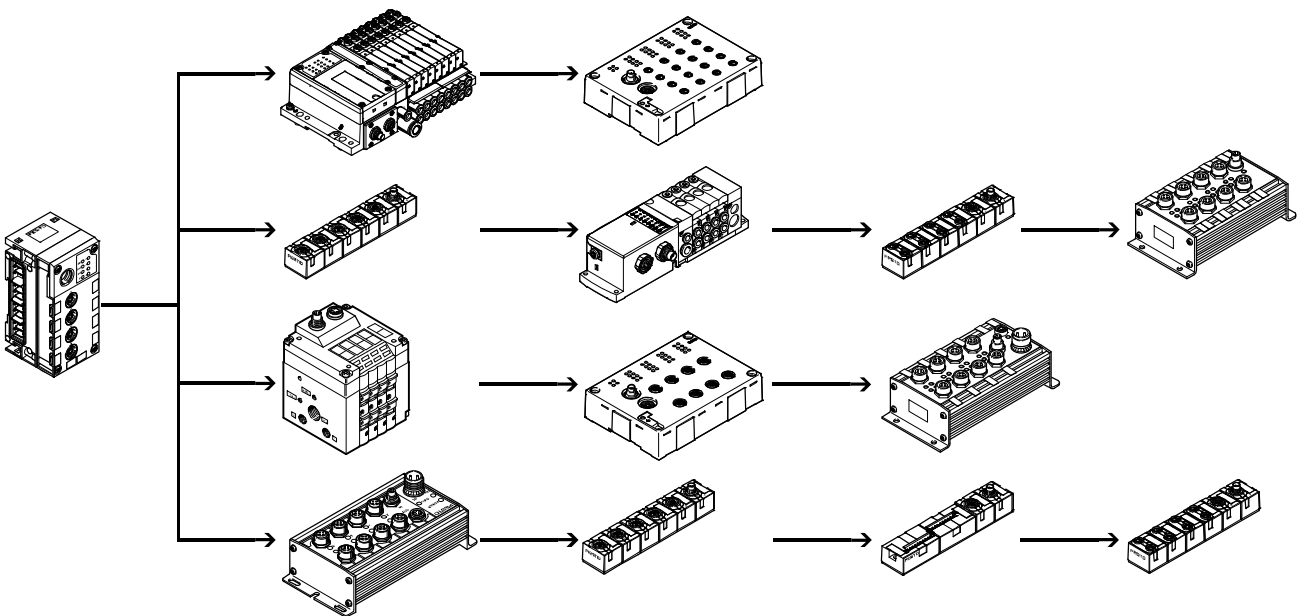

Terminal CPX

Technical data – CPX-CP interface

Implementation

The CPX-CP interface supports the CPI system:

- Max. 4 individual electronically protected CP strings
- Max. 4 CP modules per string
- Max. 32 inputs/32 outputs per string
- The maximum length of a string is 10 m. If the CP interface is positioned centrally, the CP system can cover an area of 20 m in diameter
- Modules with CPI functionality

The following CP module variants are available:

- Input modules with 8 or 16 digital inputs (connection technology M8, M12 and CageClamp)
- Output modules with 4 or 8 digital outputs (connection technology M12)
- Valve terminals with CP string extension (up to 32 solenoid coils, different valve functions)

CPI modules support the following functions:

- Module-oriented diagnostics
- Module/channel-oriented parameterisation
- Support for all functions by the CPX-MMI or CPX-FMT operator unit
- Module can be positioned anywhere within the string

Several CP interface modules can be combined in one CPX terminal, depending on the address capacity of the bus node.

Example:

- CPX-FB13 (512 I/O)
- Max. 4 CP interface modules (128 I/O each) possible



Note

When arranging the CP modules it should be taken into consideration that CP input modules without CPI functionality should always be placed at the end of a string.

Configuration

The following rules apply for a string of a CPX-CP interface:

- Max. one output module or one valve terminal without CPI functionality
- Max. one output module without CPI functionality or one valve terminal with CP string extension
- Any number of CP modules with CPI functionality, up to the maximum limit of 4 modules and/ or 32 inputs/32 outputs per string

Maximum extension:

- 4 input modules and 4 valve terminals/output modules without CPI functionality
- 16 CP modules with CPI functionality

The configuration of the strings with respect to the module type and position of the modules in the string is entered by activating the SAVE key in the CPX-CP interface and saved there permanently.

Saved data are retained even when the CP interface is isolated from the voltage supply.

The representation of the CP interface within a CPX terminal and thus at the fieldbus is dependent on the characteristics of the relevant fieldbus system. In addition to input and output addressing, this also applies to the representation of the diagnostics and parameterisation of the CP module and the characteristics of the CPI system.

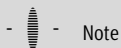

Note

The remanent saving of configuration data means that changes in the configuration or faulty modules are still displayed even after a voltage failure.

Terminal CPX

Technical data – CPX-CP interface

FESTO

General technical data			
Type	CPX-CP-4-FB		
Brief description		CP interface	
Max. number of	CP strings	4	
	CP modules per string	4	
	Outputs per string	32	
	Inputs per string	32	
CP connection		M9 socket, 5-pin	
Baud rate	[kbit/s]	1,000	
Cycle time	CP modules without CPI functionality	[ms]	4
	CP modules with CPI functionality	[ms]	2
LED displays		L1 ... 4 = Status of the CP string 1 ... 4 PS = Electronic supply, sensor supply PL = Load supply RN = Status of the CP system SF = System fault	
Device-specific diagnostics		Via bus node	
Operating voltage	Nominal value	[V DC]	24 (reverse polarity protected)
	Permissible range	[V DC]	18 ... 30
	Power failure buffering	[ms]	20
Supply voltage of sensors		[V DC]	24 ±25% coming from bus node
Load voltage of actuators		[V DC]	24 ±10% coming from bus node
Current consumption	Without CP modules	[A]	Max. 0.2
	Per CP string	[A]	Max. 1.6
Protection class to EN 60529		IP65, IP67	
Temperature range	Operation	[°C]	-5 ... +50
	Storage/transport	[°C]	-20 ... +70
Materials		PA	
Grid dimension		[mm]	50
Dimensions (incl. interlinking block) W x L x H		[mm]	50 x 107 x 45
Weight		[g]	140

 - Note

Please observe the general limits and guidelines for the system when configuring the electrical modules.

Terminal CPX

Accessories CPX-CP interface

Connection and display components

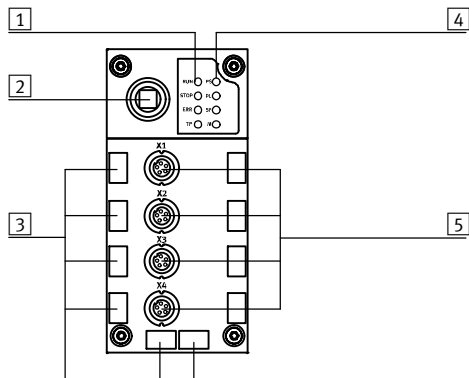

- 1 CP string LEDs
- 2 SAVE key
- 3 Holders for inscription labels (IBS 6x10)
- 4 CPX-specific status LEDs
- 5 CP connections for up to 4 strings (0 ... 3)

Power supply

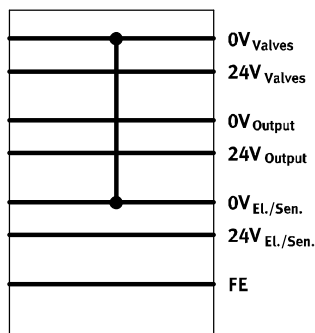





The module combines the 0 V potential of the power supply for electronics and sensors with the 0 V potential of the power supply for valves.
 If all poles of the valves of a pneumatic interface connected to the right of the CP interface are to be switched off, an appropriate interlinking block with additional power supply must be used to the right of the CP interface.

Terminal CPX

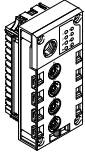
Accessories CPX-CP interface

FESTO

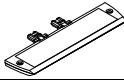
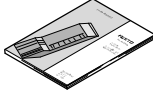
Ordering data				
Designation			Part No.	Type
CP interface				
	Interface for max. 16 I/O modules and valve terminals of the CPI system		526705	CPX-CP-4-FB
Bus connection				
	Cover cap	M12	165592	ISK-M12
	Connecting cable, angled plug, angled socket	0.25 m	540327	KVI-CP-3-WS-WD-0,25
		0.5 m	540328	KVI-CP-3-WS-WD-0,5
		2 m	540329	KVI-CP-3-WS-WD-2
		5 m	540330	KVI-CP-3-WS-WD-5
		8 m	540331	KVI-CP-3-WS-WD-8
	Connecting cable, straight plug, straight socket	2 m	540332	KVI-CP-3-GS-GD-2
		5 m	540333	KVI-CP-3-GS-GD-5
		8 m	540334	KVI-CP-3-GS-GD-8
	Inscription label holder for connection block		536593	CPX-ST-1
User manual				
	User manual for CPX-CP interface	German	539293	P.BE-CPX-CP-DE
		English	539294	P.BE-CPX-CP-EN
		Spanish	539295	P.BE-CPX-CP-ES
		French	539296	P.BE-CPX-CP-FR
		Italian	539297	P.BE-CPX-CP-IT

Terminal CPX

Technical data – Interface CPX-CTEL

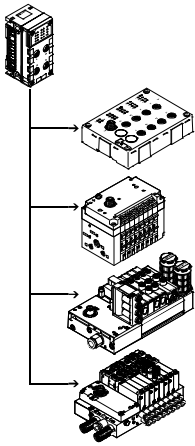

The electrical interface CPX-CTEL master establishes the connection to modules with I-Port interface (device) from the CTEL/CTEU series. The I/O data from the connected devices is transferred to the connected CPX bus node and therefore transferred to the higher-level controller via fieldbus. A maximum of 4 devices can be connected to a CPX-CTEL master via appropriate M12- interfaces.



Application

I-Port interface

As well as transmitting the communication data, the I-Port interfaces of a CPX-CTEL master also transmit the power supply for the

connected sensors and the load supply for the valves (or outputs). Both circuits are supplied separately

with 24 V, with a separate reference potential. The connecting cables used must meet

the increased requirements resulting from their double function as a signal line and power supply cable.

Sample configuration – CPX-CTEL master with CTEL modules

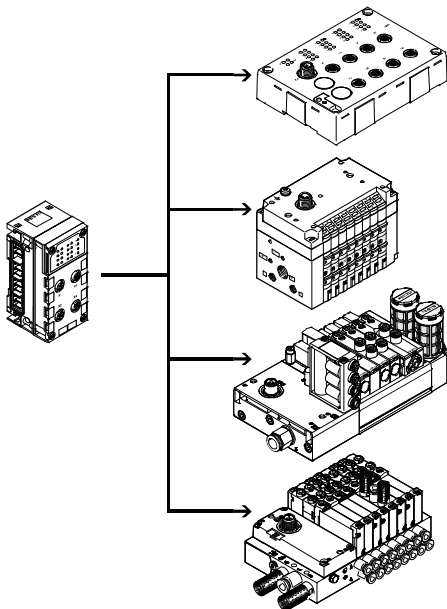

The CPX-CTEL master provides four I-Port interfaces to which one device each can be connected. I-Port is an interface for exchanging serial data for connecting decentralised modules or valve terminals from Festo. The I-Port interface is based on IO-Link and is compatible with it in certain areas. The connection type corresponds to a star topology. In other words, only one module or valve terminal can be connected to each I-Port.

The restrictions compared to IO-Link include:

- Permanently set baud rate of 230.4 kbit/s
- SIO mode is not supported
- Max. 32 bytes of input data and 32 bytes of output data
- Only one dump of the master commands is used
- Configuration via IODD is not supported

Terminal CPX

Technical data – Interface CPX-CTEL

Implementation

The CPX-CTEL master from Festo enables modules with an I-Port interface to be connected to a CPX system:

- Max. 4 devices with individual electronic fuse protection
- Max. 64 inputs/64 outputs per I-Port interface
- The maximum length of a string is 20 m

The following device variants are available:

- Input modules with 16 digital inputs (3-pin M8 and 5-pin M12 connection technology)
- Valve terminals with I-Port interface (up to 48 solenoid coils, different valve functions)

The decentralised arrangement of the modules and valve terminals with I-Port enables them to be mounted near the cylinders and actuators/sensors to be controlled.

This allows the use of shorter air supply lines and sensor connecting cables or possibly smaller valves, which saves costs.

Several CPX-CTEL masters can be combined in one CPX terminal, depending on the address capacity of the bus node.

Example:

- CPX-FB13 (512 I/O)
- Max. 2 CPX-CTEL masters (256 I/O each) possible

Configuration

Setting

The precise number of I/O bytes made available is geared towards the requirements of the connected devices and the selected operating mode. The operating mode and configuration presetting of the CPX-CTEL master can be defined by the user.

DIL switches are used for selecting the operating mode and making the setting for manual configuration. These DIL switches are not required during operation and are only accessible in unassembled condition.

Manual configuration

With manual configuration (tool change mode), the number of inputs and outputs in the process image of the CPX system or higher-level fieldbus can be manually defined via the DIL switches.

The process image then always has the same number of bytes, regardless of the connected devices. The defined I/O length always applies to all four I-Ports (max. 8 bytes per I-Port).

Automatic configuration

With automatic configuration, the I/O length for each I-Port is individually determined and this value is used to select the appropriate or next highest configuration presetting.

Power supply for I-Port devices

The CPX-CTEL master provides two separate power supplies for the connected devices:

- One for operating the device and the inputs connected to it
- One for outputs and valves connected to the device

The power supply for devices and inputs comes from the power supply for the electronics and sensors of the CPX terminal.

The power supply for outputs and valves comes from the power supply

for the valves of the CPX terminal.

The interlinking block with additional power supply enables a separate voltage supply for valves and outputs. This allows this supply voltage to be

switched off separately.

In other words, the valves and outputs of the connected I-Port devices can be switched off separately without having to switch off the devices themselves.

Terminal CPX

Technical data – Interface CPX-CTEL

General technical data			
Type			CPX-CTEL-4-M12-5POL
Protocol			I-Port
Max. address capacity	Outputs	[bit]	256
	Inputs	[bit]	256
I-Port connection			4x M12 socket, 5-pin, A-coded
Number of I-Port interfaces			4
Max. cable length			[m] 20
Internal cycle time			[ms] 1 per 8 bits of user data
Electrical isolation	Channel – channel		No
	Channel – internal bus		Yes, using an intermediate supply
LED displays			X1 ... 4 = Status of the I-Port interface 1 ... 4 PS = Electronics supply PL = Load supply · 4 · = Module fault
Diagnostics			<ul style="list-style-type: none"> • Communication error • Module short circuit • Module-oriented diagnostics • Undervoltage
Parameterisation			<ul style="list-style-type: none"> • Diagnostic behaviour • Failsafe per channel • Forces per channel • Idle mode per channel • Module parameters • Tool change mode
Additional functions			Tool change mode
Operating elements			DIL switch
Operating voltage	Nominal value		[V DC] 24 (reverse polarity protected)
	Permissible range		[V DC] 18 ... 30
	Power failure buffering		[ms] 10
Intrinsic current consumption at nominal operating voltage			[mA] Typically 65
Max. power supply per channel			[A] 4x 1.6
Max. residual output current per channel			[A] 4x 1.6
Protection class to EN 60529			IP65, IP67
Temperature range	Operating		[°C] –5 ... +50
	Storage/transport		[°C] –20 ... +70
Materials			PA reinforced, PC
Note on materials			RoHS-compliant
Grid dimension			[mm] 50
Dimensions (incl. interlinking block) W x L x H			[mm] 50 x 107 x 55
Product weight			[g] 110

-  - Note

Please observe the general limits and guidelines for the system when configuring the electrical modules.

Terminal CPX

Technical data – Interface CPX-CTEL

Connection and display components

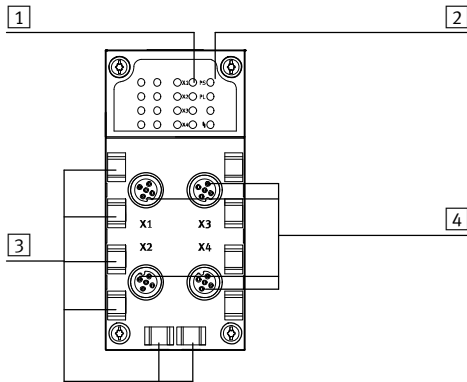

- 1 Status LEDs for I-Port interfaces
- 2 CPX-specific status LEDs
- 3 Holders for inscription labels (IBS 6x10)
- 4 I-Port interfaces for up to 4 devices

Combinations of bus nodes/control blocks and interface CPX-CTEL

Bus node/control block	Part No.	Interface	
		CPX-CTEL-4-M12-5POL	
CPX-CEC-C1	567347		■
CPX-CEC-C1-V3	3473128		■
CPX-CEC-M1-V3	3472765		■
CPX-CEC	567346		■
CPX-CEC-S1-V3	3472425		■
CPX-FB11	526172		■
CPX-FB13	195740		■
CPX-FB14	526174		■
CPX-FB23-24	526176		■
CPX-FB33	548755		■
CPX-M-FB34	548751		■
CPX-M-FB35	548749		■
CPX-FB36	1912451		■
CPX-FB37	2735960		■
CPX-FB38	552046		■
CPX-FB39	2093101		■
CPX-FB40	2474896		■
CPX-M-FB41	3228960		■

Pin allocation – I-Port interface

Pin allocation	Pin	Signal	Designation
	1	24 V _{SEN}	24 V DC supply voltage for electronics and inputs
	2	24 V _{VAL}	24 V DC load voltage supply for valves and outputs
	3	0 V _{SEN}	0 V DC supply voltage for electronics and sensors
	4	C/Q I-Port	Communication signal C/Q, data cable
	5	0 V _{VALVES}	0 V DC load voltage supply for valves and outputs

Terminal CPX

Technical data – Interface CPX-CTEL

Dimensions

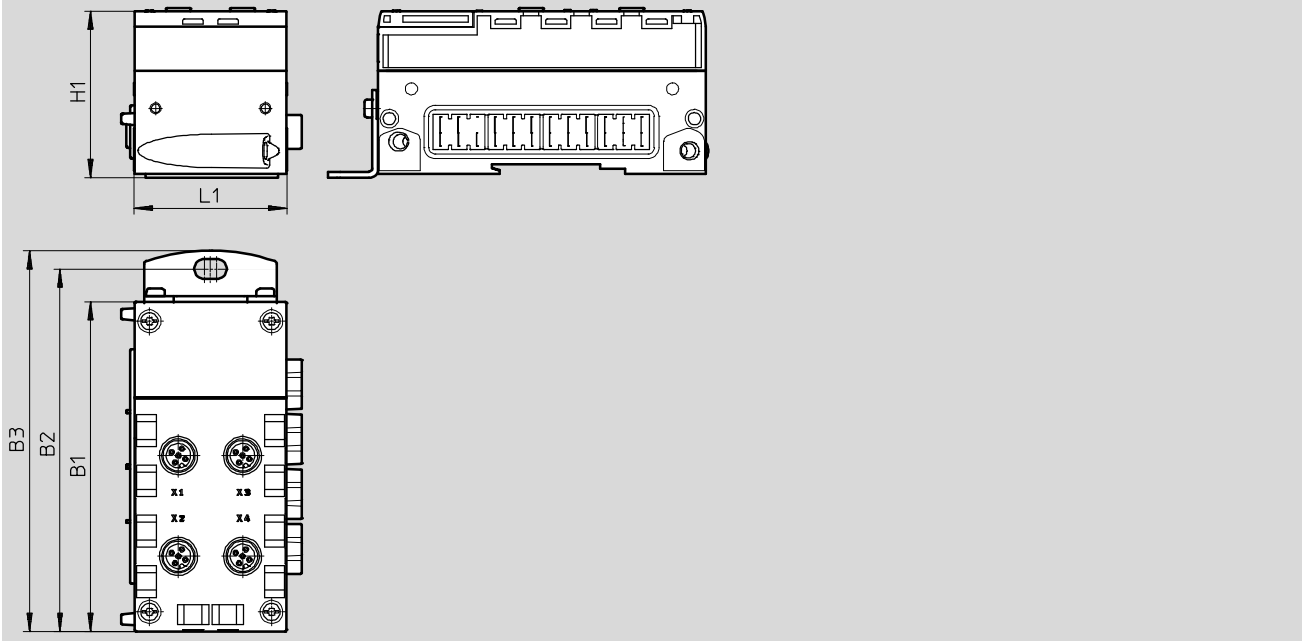

Download CAD data → www.festo.com



Type	B1	B2	B3	H1	L1
CPX-CTEL-4-M12-5POL	108.1	118.9	124.9	55.1	50

Terminal CPX

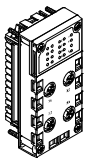
Accessories – Interface CPX-CTEL

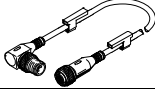
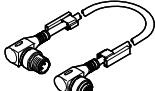
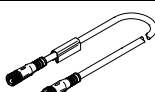
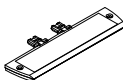
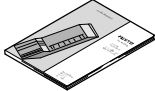
Ordering data					
Designation				Part No.	Type
CPX-CTEL master					
	Interface for max. 4 I/O modules and valve terminals with I-Port interface (devices)			1577012	CPX-CTEL-4-M12-5POL
Bus connection					
	Cover cap	M12		165592	ISK-M12
	Connecting cable M12-M12, 5-pin • Straight socket • Angled plug	Cable characteristics: standard	0.5 m	8003617	NEBU-M12G5-K-0.5-M12W5
			2 m	8003618	NEBU-M12G5-K-2-M12W5
	Connecting cable M12-M12, 5-pin • Angled socket • Angled plug	Cable characteristics: standard	0.5 m	570733	NEBU-M12W5-K-0.5-M12W5
			2 m	570734	NEBU-M12W5-K-2-M12W5
	Connecting cable M12-M12, 5-pin • Straight socket • Staright plug	Cable characteristics: Suitable for chain link trunking	5 m	574321	NEBU-M12G5-E-5-Q8N-M12G5
			7.5 m	574322	NEBU-M12G5-E-7.5-Q8N-M12G5
			10 m	574323	NEBU-M12G5-E-10-Q8N-M12G5
	Inscription label holder for manifold block			536593	CPX-ST-1
Manual					
	Manual CPX-CTEL master	German		574600	P.BE-CPX-CTEL-DE
		English		574601	P.BE-CPX-CTEL-EN
		Spanish		574602	P.BE-CPX-CTEL-ES
		French		574603	P.BE-CPX-CTEL-FR
		Italian		574604	P.BE-CPX-CTEL-IT

Terminal CPX

Technical data – Interface CPX-CTEL-2

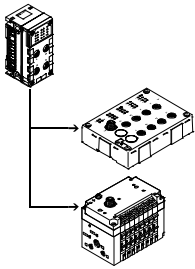

The electrical interface CPX-CTEL-2... enables the connection of modules with IO-Link interface (IO-Link device) to the CPX terminal. The I/O data of the connected devices are transmitted to the connected CPX bus node and thus to the higher-order controller via fieldbus. A maximum of two IO-Link devices can be connected to an electrical interface CPX-CTEL-2... via the corresponding M12 interfaces.



Application

IO-Link interface

The communication system IO-Link is used to exchange serial data from decentralised function modules (devices) at the field level. The electrical interface CPX-CTEL-2... provides two IO-Link interfaces to the

outside, on each of which one device can be connected. The connection type corresponds to a star topology, which means that only one device can be connected to each port.

The address space that the module makes available and assigns accordingly in the CPX system can be configured according to various presettings. Selection of the operating mode and

the setting for manual configuration takes place via the DIL switches. These DIL switches are not required during continuous operation and are only accessible in the disassembled state.

Restrictions

The interfaces (ports) of electrical interface CPX-CTEL-2... support the connection of IO-Link devices with few limitations.

- The process data length of the inputs and outputs is limited to 16 bytes per port for inputs and outputs
- The driver strength on the C/Q line is limited to 250 mA
- SIO mode is not supported

Power supply for devices

The electrical interface CPX-CTEL-2... provides two separate power supplies for the connected devices:

- For the operation of the device and the inputs connected to it
- For the outputs and valves that are connected to the device

The power supply for the devices and the inputs is supplied by the power supply for the electronics and sensors of the CPX terminal. The power supply for the outputs and valves is supplied by the power supply

for the valves of the CPX terminal. The interlinking block with additional supply ensures a separate the supply voltage for the valves and outputs. This means it is possible to disconnect this supply voltage

separately. The valves and outputs of the connected I-Port devices can therefore be disconnected separately without disconnecting the devices.

Terminal CPX

Technical data – Interface CPX-CTEL-2

General technical data			
Type			CPX-CTEL-2-M12-5POL-LK
Protocol			IO-Link, master version V 1.0
Max. address capacity	Outputs	[bit]	256
	Inputs	[bit]	256
I-Port connection			2x socket M12, 5-pin, A-coded
Number of IO-Link interfaces			2
Max. cable length			[m] 20
Internal cycle time			[ms] 1 per 8 bits of user data
Electrical isolation	Channel – channel		No
	Channel – internal bus		Yes, using an intermediate supply
LED displays			X1 ... 2 = status of the IO-Link interface 1 ... 2 PS = Electronic supply PL = Load supply  = Module error
Diagnostics			<ul style="list-style-type: none"> • Communication error • Module short circuit • Module-oriented diagnostics • Undervoltage
Parameterisation			<ul style="list-style-type: none"> • Diagnostic behaviour • Fail-safe mode per channel • Forcing per channel • Idle mode per channel • Module parameters
Additional functions			–
Control elements			DIL switches
Operating voltage	Nominal value	[V DC]	24 (polarity-safe)
	Permissible range	[V DC]	18 ... 30
	Power failure buffering	[ms]	10
Intrinsic current consumption at nominal operating voltage			[mA] Typically 65
Max. power supply per channel			[A] 2 x 1.6
Max. residual current of outputs per channel			[A] 2x 1.6
Degree of protection to EN 60529			IP65, IP67
Temperature range	Operation	[°C]	–5 ... +50
	Storage/transport	[°C]	–20 ... +70
Materials			PA reinforced, PC
Note on materials			RoHS-compliant
Grid dimension			[mm] 50
Dimensions (incl. interlinking block) W x L x H			[mm] 50 x 107 x 55
Product weight			[g] 110

 Note
Please observe the general limits and guidelines for the system when configuring the electrical modules.

Terminal CPX

Technical data – Interface CPX-CTEL-2

Connection and display components

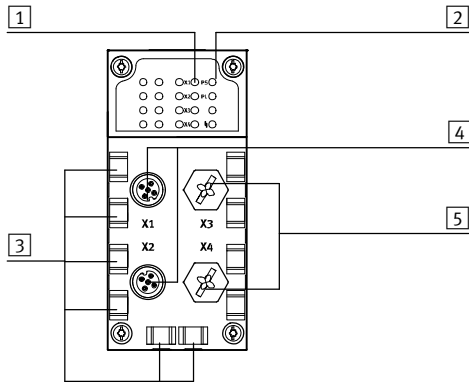

- 1 Status LEDs for I-Port interfaces
- 2 CPX-specific status LEDs
- 3 Holders for inscription labels (IBS 6x10)
- 4 IO-Link interfaces for up to 2 devices
- 5 Unoccupied connections

Combinations of bus nodes/control blocks and interface CPX-CTEL-2

Bus node/control block	Part No.	Interface
		CPX-CTEL-2-M12-5POL-LK
CPX-CEC-C1-V3	3473128	■
CPX-CEC-M1-V3	3472765	■
CPX-CEC-S1-V3	3472425	■
CPX-FB33	548755	■
CPX-M-FB34	548751	■
CPX-M-FB35	548749	■
CPX-FB36	1912451	■
CPX-FB39	2093101	■

Pin allocation of IO-Link interface

Pin allocation	Pin	Signal	Designation
	1	24 V _{SEN}	24 V DC supply voltage for electronics and inputs
	2	24 V _{VAL}	24 V DC load voltage supply for valves and outputs
	3	0 V _{SEN}	0 V DC supply voltage for electronics and sensors
	4	C/Q I-PORT	Communication signal C/Q, data cable
	5	0 V _{VALVES}	0 V DC load voltage supply for valves and outputs

Terminal CPX

Technical data – Interface CPX-CTEL-2

Dimensions



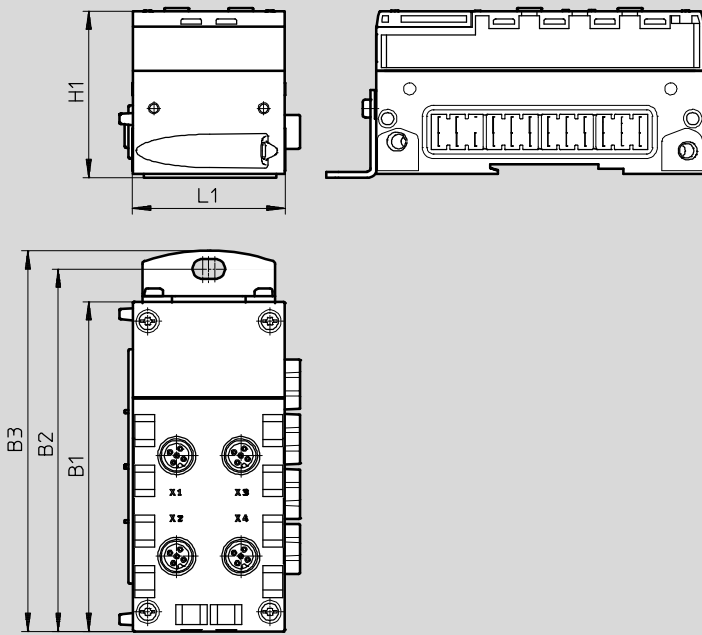

Download CAD data → www.festo.com

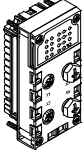

Type	B1	B2	B3	H1	L1
CPX-CTEL-2-M12-5POL-LK	108.1	118.9	124.9	55.1	50

Terminal CPX

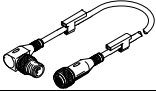
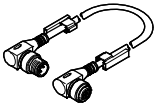
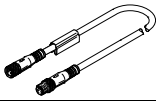
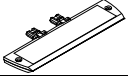
Interface accessories CPX-CTEL-2

Ordering data			
Designation		Part No.	Type
CPX CTEL-Master, IO-Link			
	Interface for max. 2 I/O modules and valve terminals with IO-Link interface (devices)	2900543	CPX-CTEL-2-M12-5POL-LK
Bus connection			
	Cover cap	M12	165592 ISK-M12
	Connecting cable M12-M12, 5-pin • Straight socket • Angled plug	Cable characteristics: standard	0.5 m 8003617 NEBU-M12G5-K-0.5-M12W5
			2 m 8003618 NEBU-M12G5-K-2-M12W5
	Connecting cable M12-M12, 5-pin • Angled socket • Angled plug	Cable characteristics: standard	0.5 m 570733 NEBU-M12W5-K-0.5-M12W5
			2 m 570734 NEBU-M12W5-K-2-M12W5
	Connecting cable M12-M12, 5-pin • Straight socket • Staright plug	Cable characteristics: Suitable for chain link trunking	5 m 574321 NEBU-M12G5-E-5-Q8N-M12G5
			7.5 m 574322 NEBU-M12G5-E-7.5-Q8N-M12G5
			10 m 574323 NEBU-M12G5-E-10-Q8N-M12G5
	Inscription label holder for connection block		536593 CPX-ST-1
User documentation			
	User documentation for CPX CTEL-Master	German	8034115 P.BE-CPX-CTEL-LK-DE
		English	8034116 P.BE-CPX-CTEL-LK-EN
		Spanish	8034117 P.BE-CPX-CTEL-LK-ES
		French	8034118 P.BE-CPX-CTEL-LK-FR
		Italian	8034119 P.BE-CPX-CTEL-LK-IT
		Swedish	8034120 P.BE-CPX-CTEL-LK-ZH

Control block CPX-CM-HPP

Technical data



The control block CPX-CM-HPP is a module in the CPX terminal for controlling electric drives.

The control component is independent of the bus node used. This means that Festo's electric drive technology is compatible with all industrial communication interfaces.

The control block does not need to be programmed.

- Max. 4 individual electric axes can be controlled via CAN bus
- No programming required
- Standardised communication with the drives via the Festo Handling and Positioning Profile (FHPP)
- Quick configuration and diagnostics via the operator unit CPX-MMI
- Simple, flexible and cost-effective



General technical data		
Fieldbus interface		1x socket M9, 5-pin
Protocol		FHPP
Max. address volume for inputs	[byte]	32
Max. address volume for outputs	[byte]	32
LED display (product-specific)	Error:	Error
	PL:	Power supply
Device-specific diagnostics		Diagnostic memory
		Channel and module-oriented diagnostics
		Undervoltage/short circuit of modules
Parameterisation		Forcing of channels
		System parameters
Configuration support		Operator unit CPX-MMI
Total number of axes		4
Nominal operating voltage	[V DC]	24
Operating voltage range	[V DC]	18 ... 30
Power failure buffering	[ms]	10
Intrinsic current consumption at nominal operating voltage	[mA]	Typically 80
Protection class to EN 60529 (plug connector plugged in)		IP65, IP67
Dimensions W x L x H (incl. interlinking block)	[mm]	50 x 107 x 55
Product weight (without interlinking block)	[g]	140
Materials		
Housing		PA, reinforced
		PC
Note on materials		RoHS-compliant

Technical data – Interfaces		
Interface		
Control interface		CAN-Bus
Baud rate	[Mbps]	1

Operating and environmental conditions		
Ambient temperature	[°C]	-5 ... +50
Storage temperature	[°C]	-20 ... +70
CE mark (see declaration of conformity)		To EU Low Voltage Directive

Control block CPX-CM-HPP

Technical data

Connection and display components

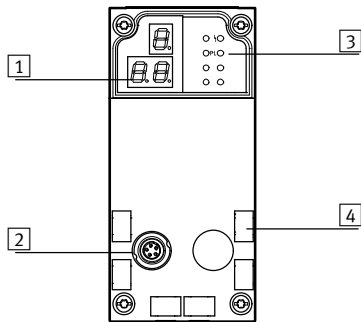

- 1 3-digit display
- 2 Control interface
- 3 LED display, product-specific
- 4 Inscription labels

Pin allocation – Control interface

	Pin	Signal	Meaning
Socket M9, 5-pin			
	1	n.c.	Not connected
	2	n.c.	Not connected
	3	CAN_GND	CAN ground
	4	CAN_H	CAN high
	5	CAN_L	CAN low
Housing	Screened	Cable screen must be connected to functional earth (FE)	

Permitted bus nodes/CEC



Bus node/CEC	Protocol	Max. no. of CPX-CM-HPP modules
CPX-CEC...	–	0
CPX-FB6	INTERBUS	0
CPX-FB11	DeviceNet	2
CPX-FB13	PROFIBUS	2
CPX-FB14	CANopen	1
CPX-M-FB21	INTERBUS	0
CPX-FB23-24	CC-Link	1 (function module F23)
		0 (function module F24)
CPX-FB33	PROFINET RT, M12	2
CPX-M-FB34	PROFINET RT, RJ45	2
CPX-M-FB35	PROFINET RT, SCRJ	2
CPX-FB36	EtherNet/IP	2
CPX-FB37	EtherCAT	2
CPX-FB38	EtherCAT	2
CPX-FB39	Sercos III	2
CPX-FB40	POWERLINK	2
CPX-M-FB41	PROFINET RT	2

Control block CPX-CM-HPP

Accessories

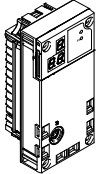
FESTO

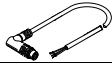
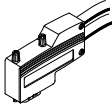
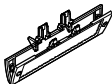
Ordering data		Part No.	Type
Designation			
Control block			
	Max. 4 individual electric axes can be controlled via CAN bus	562214	CPX-CM-HPP

Ordering data – Bus connection			
Designation		Part No.	Type
Connecting cable			
	Connecting cable	2 m	563711 NEBC-M9W5-K-2-N-LE3
		5 m	563712 NEBC-M9W5-K-5-N-LE3
	Plug for CAN bus interface, Sub-D, 9-pin, without terminating resistor	533783	FBS-SUB-9-WS-CO-K
Inscription label			
	Inscription label holder for manifold block	536593	CPX-ST-1
Documentation			
	Manual – Control block CPX-CM-HPP	German	568683 CPX-CM-HPP-DE
		English	568684 CPX-CM-HPP-EN

Axis controllers CPX-CMAX

Technical data

The axis controller CPX-CMAX is intended exclusively for valve terminals CPX.



General technical data

Operating voltage			
Operating voltage range	[V DC]	18 ... 30	
Nominal operating voltage	[V DC]	24	
Current consumption at nominal operating voltage	[mA]	200	
Fuse protection (short circuit)		Electronic	
Power failure bridging	[ms]	10	
Load voltage			
Load voltage range	[V DC]	20 ... 30	
Nominal load voltage	[V DC]	24	
Perm. load current	[A]	2.5	
Fuse protection (short circuit)		Electronic	
Number of axis strings		1	
Axes per string		1	
Length of connecting cable to axis	[m]	≤ 30	
Max. no. of modules		7	
Display		7-segment display	
Assigned addresses	Outputs	[bit]	8x8
	Inputs	[bit]	8x8
Operating modes		Record Select mode	
		Direct mode	
Controller types		Position control	
		Force control	
Diagnostics		Module-orientated	
		Via local 7-segment display	
Status display		Module status	
		Power Load	
		Display/Error Axis X	
		MC Axis X	
Control interface			
Data		CAN bus with Festo protocol	
		Digital	
Electrical connection		5-pin	
		M9	
		Socket	
Materials: Housing		Reinforced PA	
Note on materials		RoHS-compliant	
Product weight	[g]	140	
Dimensions	Length	[mm]	107
	Width	[mm]	50
	Height	[mm]	55

Axis controllers CPX-CMAX

Technical data

FESTO

Operating and environmental conditions		
Ambient temperature	[°C]	-5 ... +50
Relative air humidity	[%]	5 ... 95, non-condensing
Protection class to IEC 60529		IP65

Connection and display components

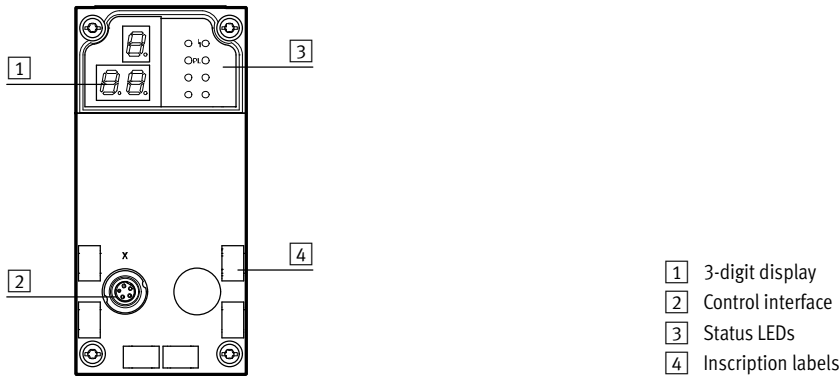

- 1 3-digit display
- 2 Control interface
- 3 Status LEDs
- 4 Inscription labels

Pin allocation – Control interface			
	Pin	Signal	Designation
	1	+24 V	Nominal operating voltage
	2	+24 V	Load voltage
	3	0 V	Ground
	4	CAN_H	CAN high
	5	CAN_L	CAN low
	Housing	Screened	Cable screening

Permitted bus nodes/CEC		
Bus node/CEC	Protocol	Max. no. of CMAX modules
CPX-CEC...	-	8
CPX-FB6	INTERBUS	1
CPX-FB11	DeviceNet ¹⁾	8
CPX-FB13	PROFIBUS ²⁾	8
CPX-FB14	CANopen	4
CPX-M-FB21	INTERBUS	1
CPX-FB23-24	CC-Link	4 (function module F23)
		8 (function module F24)
CPX-FB33	PROFINET RT, M12	8
CPX-M-FB34	PROFINET RT, RJ45	8
CPX-M-FB35	PROFINET RT, SCRJ	8
CPX-FB36	EtherNet/IP	8
CPX-FB37	EtherCAT	8
CPX-FB38	EtherCAT	8
CPX-FB39	Sercos III	8
CPX-FB40	POWERLINK	8
CPX-M-FB41	PROFINET RT	8



1) With Revision 20 (R20)
 2) With Revision 23 (R23)

PROFIBUS®, DeviceNet®, CANopen®, INTERBUS®, CC-LINK®, EtherCAT®, PROFINET®, Sercos®, EtherNet/IP® is a registered trademark of its respective trademark holder in certain countries.

Axis controllers CPX-CMAX

Accessories

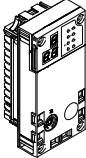
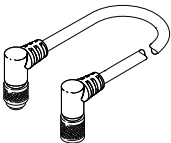
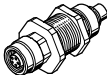
FESTO

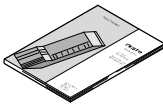
Ordering data		Brief description	Part No.	Type
Axis controller				
	Order code in the CPX configurator: T21		548932	CPX-CMAX-C1-1
Connecting cables				
	Connecting cable with angled plug and angled socket	0.25 m	540327	KVI-CP-3-WS-WD-0,25
		0.5 m	540328	KVI-CP-3-WS-WD-0,5
		2 m	540329	KVI-CP-3-WS-WD-2
		5 m	540330	KVI-CP-3-WS-WD-5
		8 m	540331	KVI-CP-3-WS-WD-8
	Connecting cable with straight plug and straight socket	2 m	540332	KVI-CP-3-GS-GD-2
5 m		540333	KVI-CP-3-GS-GD-5	
8 m		540334	KVI-CP-3-GS-GD-8	
	Connector for control cabinet through-feed		543252	KVI-CP-3-SSD
Screws				
	For mounting on the metal interlinking block		550219	CPX-M-M3X22-4X
Inscription labels				
	Inscription labels 6x10, in frames	64 pieces	18576	IBS-6X10
User manual				
	Axis controller description CPX-CMAX ¹⁾	German	559750	P.BE-CPX-CMAX-SYS-DE
		English	559751	P.BE-CPX-CMAX-SYS-EN
		Spanish	559752	P.BE-CPX-CMAX-SYS-ES
		French	559753	P.BE-CPX-CMAX-SYS-FR
		Italian	559754	P.BE-CPX-CMAX-SYS-IT

1) User manual in paper form is not included in the scope of delivery.

End-position controllers CPX-CMPX

Technical data

The end-position controller CPX-CMPX is intended exclusively for use in valve terminals CPX.



General technical data			
Operating voltage			
Operating voltage range	[V DC]	18 ... 30	
Nominal operating voltage	[V DC]	24	
Current consumption at nominal operating voltage	[mA]	80	
Load voltage			
Load voltage range	[V DC]	20 ... 30	
Nominal load voltage	[V DC]	24	
Perm. load current	[A]	2.5	
Number of axes per module			
		1	
Length of connecting cable to axis	[m]	≤ 30	
Max. no. of modules			
		9	
Display			
		7-segment display	
Control elements			
		3 keys	
Assigned addresses	Outputs	[bit]	6x8
	Inputs	[bit]	6x8
Diagnostics			
		Module-orientated	
		Via local 7-segment display	
		Via operator unit CPX-MMI-1	
Status display			
		Module status	
		Power Load	
Control interface			
Data		CAN bus with Festo protocol	
		Digital	
Electrical connection		5-pin	
		M9	
		Socket	
Materials: Housing			
		Reinforced PA	
Product weight	[g]	240	
Dimensions	Length	[mm]	107
	Width	[mm]	50
	Height	[mm]	55

End-position controllers CPX-CMPX

Technical data

FESTO

Operating and environmental conditions

Ambient temperature	[°C]	-5 ... +50
Relative air humidity	[%]	5 ... 95, non-condensing
Protection class to IEC 60529		IP65
CE mark (see declaration of conformity)		To EU EMC Directive

Connection and display components

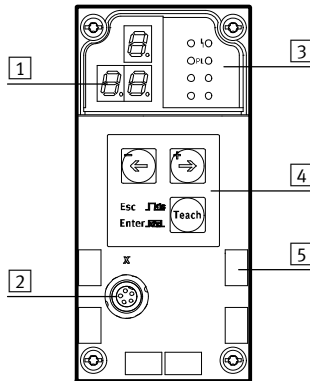

- 1 3-digit display
- 2 Control interface
- 3 Status LEDs
- 4 Operating buttons
- 5 Inscription labels

Pin allocation – Control interface

	Pin	Signal	Designation
	1	+24 V	Nominal operating voltage
	2	+24 V	Load voltage
	3	0 V	Ground
	4	CAN_H	CAN high
	5	CAN_L	CAN low
	Housing	Screened	Cable screening

Permitted bus nodes/CEC

Bus node/CEC	Protocol	Max. no. of CMPX modules
CPX-CEC...	-	9
CPX-FB6	INTERBUS	2
CPX-FB11	DeviceNet ¹⁾	9
CPX-FB13	PROFIBUS ²⁾	9
CPX-FB14	CANopen	5
CPX-M-FB21	INTERBUS	2
CPX-FB23-24	CC-Link	5 (function module F23)
		9 (function module F24)
CPX-FB33	PROFINET RT, M12	9
CPX-M-FB34	PROFINET RT, RJ45	9
CPX-M-FB35	PROFINET RT, SCRJ	9
CPX-FB36	EtherNet/IP	9
CPX-FB37	EtherCAT	9
CPX-FB38	EtherCAT	9
CPX-FB39	Sercos III	9
CPX-FB40	POWERLINK	9
CPX-M-FB41	PROFINET RT	9

1) With Revision 20 (R20)



2) With Revision 23 (R23)

PROFIBUS®, DeviceNet®, CANopen®, INTERBUS®, CC-LINK®, EtherCAT®, PROFINET®, Sercos®, EtherNet/IP® is a registered trademark of its respective trademark holder in certain countries.

End-position controllers CPX-CMPX

Accessories

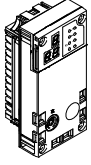
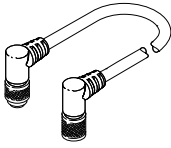
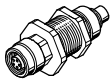
FESTO

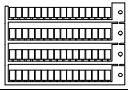
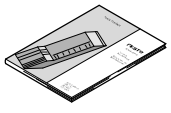
Ordering data		Brief description	Part No.	Type
End-position controller				
	Order code in the CPX configurator: T20		548931	CPX-CMPX-C-1-H1
Connecting cables				
	Connecting cable with angled plug and angled socket	0.25 m	540327	KVI-CP-3-WS-WD-0,25
		0.5 m	540328	KVI-CP-3-WS-WD-0,5
		2 m	540329	KVI-CP-3-WS-WD-2
		5 m	540330	KVI-CP-3-WS-WD-5
		8 m	540331	KVI-CP-3-WS-WD-8
	Connecting cable with straight plug and straight socket	2 m	540332	KVI-CP-3-GS-GD-2
5 m		540333	KVI-CP-3-GS-GD-5	
8 m		540334	KVI-CP-3-GS-GD-8	
	Connector for control cabinet through-feed		543252	KVI-CP-3-SSD
Screws				
	For mounting on the metal interlinking block		550219	CPX-M-M3X22-4X
Inscription labels				
	Inscription labels 6x10, in frames	64 pieces	18576	IBS-6X10
User manual				
	End-position controller description CPX-CMPX ¹⁾	German	555479	P.BE-CPX-CMPX-SYS-DE
		English	555480	P.BE-CPX-CMPX-SYS-EN
		Spanish	555481	P.BE-CPX-CMPX-SYS-ES
		French	555482	P.BE-CPX-CMPX-SYS-FR
		Italian	555483	P.BE-CPX-CMPX-SYS-IT

1) User manual in paper form is not included in the scope of delivery.

Measuring modules CPX-CMIX

Technical data

The measuring module CPX-CMIX is intended exclusively for use in valve terminals CPX.



General technical data			
Operating voltage			
Operating voltage range		[V DC]	18 ... 30
Nominal operating voltage		[V DC]	24
Current consumption at nominal operating voltage		[mA]	80
Protection against short circuit			Yes
Power failure bridging		[ms]	10
No. of axis strings			1
Axes per string			1
Length of connecting cable to axis		[m]	≤ 30
Max. no. of modules			9
Display			7-segment display
Assigned addresses	Outputs	[bit]	6x8
	Inputs	[bit]	6x8
Diagnostics			Channel and module-oriented
			Via local 7-segment display
			Undervoltage of modules
			Undervoltage of measuring system
Status display			Power Load
			Error
Control interface			
Data			CAN bus with Festo protocol
			Digital
Electrical connection			5-pin
			M9
			Socket
Materials: Housing			Reinforced PA
Note on materials			RoHS-compliant
Product weight		[g]	140
Dimensions	Length	[mm]	107
	Width	[mm]	50
	Height	[mm]	55

Measuring modules CPX-CMIX

Technical data

FESTO

Operating and environmental conditions		
Ambient temperature	[°C]	-5 ... +50
Relative air humidity	[%]	5 ... 95, non-condensing
Protection class to IEC 60529		IP65

Connection and display components

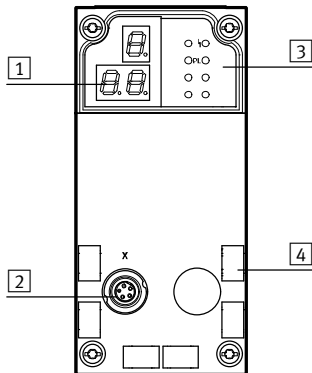

- 1 3-digit display
- 2 Control interface
- 3 Status LEDs
- 4 Inscription labels

Pin allocation – Control interface

	Pin	Signal	Designation
	1	+24 V	Nominal operating voltage
	2	+24 V	Load voltage
	3	0 V	Ground
	4	CAN_H	CAN high
	5	CAN_L	CAN low
	Housing	Screened	Cable screening

Permitted bus nodes/CEC

Bus node/CEC	Protocol	Max. no. of CMIX modules
CPX-CEC...	-	9
CPX-FB6	INTERBUS	2
CPX-FB11	DeviceNet ¹⁾	9
CPX-FB13	PROFIBUS ²⁾	9
CPX-FB14	CANopen	5
CPX-M-FB21	INTERBUS	2
CPX-FB23-24	CC-Link	5 (function module F23)
		9 (function module F24)
CPX-FB33	PROFINET RT, M12	9
CPX-M-FB34	PROFINET RT, RJ45	9
CPX-M-FB35	PROFINET RT, SCRJ	9
CPX-FB36	EtherNet/IP	9
CPX-FB37	EtherCAT	9
CPX-FB38	EtherCAT	9
CPX-FB39	Sercos III	9
CPX-FB40	POWERLINK	9
CPX-M-FB41	PROFINET RT	9

1) With Revision 20 (R20)



2) With Revision 23 (R23)

PROFIBUS®, DeviceNet®, CANopen®, INTERBUS®, CC-LINK®, EtherCAT®, PROFINET®, Sercos®, EtherNet/IP® is a registered trademark of its respective trademark holder in certain countries.

Measuring modules CPX-CMIX

Accessories

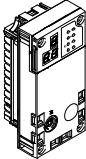
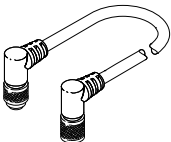
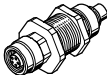
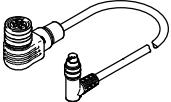
FESTO

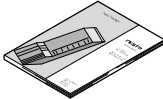
Ordering data		Brief description	Part No.	Type
Measuring module				
	Order code in the CPX configurator: T23		567417	CPX-CMIX-M1-1
Connecting cables				
	Connecting cable with angled plug and angled socket	0.25 m	540327	KVI-CP-3-WS-WD-0,25
		0.5 m	540328	KVI-CP-3-WS-WD-0,5
		2 m	540329	KVI-CP-3-WS-WD-2
		5 m	540330	KVI-CP-3-WS-WD-5
		8 m	540331	KVI-CP-3-WS-WD-8
	Connecting cable with straight plug and straight socket	2 m	540332	KVI-CP-3-GS-GD-2
5 m		540333	KVI-CP-3-GS-GD-5	
8 m		540334	KVI-CP-3-GS-GD-8	
	Connector for control cabinet through-feed		543252	KVI-CP-3-SSD
	For displacement encoder MME Connection between displacement encoder MME and measuring module CPX-CMIX	2 m	575898	NEBP-M16W6-K-2-M9W5
Screws				
	For mounting on the metal interlinking block		550219	CPX-M-M3X22-4X
Inscription labels				
	Inscription labels 6x10, in frames	64 pieces	18576	IBS-6X10
User manual				
	Measuring module description CPX-CMIX ¹⁾	German	567053	P.BE-CPX-CMIX-DE
		English	567054	P.BE-CPX-CMIX-EN
		Spanish	567055	P.BE-CPX-CMIX-ES
		French	567056	P.BE-CPX-CMIX-FR
		Italian	567057	P.BE-CPX-CMIX-IT

1) User manual in paper form is not included in the scope of delivery.

Terminal CPX

Technical data – Input module, digital

Function

Digital input modules enable the connection of two-wire and three-wire sensors (proximity sensors, inductive or capacitive sensors, etc). Depending on the connection block selected, the module supports various connection concepts with different numbers of sockets (single or double allocation).

Applications

- Input modules for 24 V DC sensor supply voltage
- PNP or NPN logic
- Supports connection blocks with M12, M8, Sub-D, Harax and terminal connection
- Module features can be parameterised
- The input module receives the voltage supply for the electronics and the sensors from the interlinking block
- Module protection and diagnostics through integrated electronic fuse protection



General technical data					
Type		CPX-4DE	CPX-8DE	CPX-8DE-D	CPX-8NDE
No. of inputs		4	8	8	8
Max. residual current of inputs per module	[A]	0.7	1	0.7	0.7
Fuse protection		Internal electronic fuse for each module	Internal electronic fuse for each module	Internal electronic fuse for each channel	Internal electronic fuse for each module
Intrinsic current consumption at operating voltage	[mA]	Typically 15			
Operating voltage	Nominal value	[V DC] 24			
	Permissible range	[V DC] 18 ... 30			
Electrical isolation	Channel – channel	No			
	Channel – internal bus	No			
Switching level	Signal 0	[V DC]	≤ 5		≥ 11
	Signal 1	[V DC]	≥ 11		≤ 5
Input debounce time	[ms]	3 (0.1, 10, 20 parameterisable)			
Input characteristic curve		IEC 1131 Part 2			
Switching logic		Positive logic (PNP)			Negative logic (NPN)
LED displays	Group diagnostics	1	1	1	1
	Channel diagnostics	–	–	8	–
	Channel status	4	8	8	8
Diagnostics		Short circuit/overload per channel			
Parameterisation		<ul style="list-style-type: none"> • Module monitoring • Behaviour after short circuit • Input debounce time • Signal stretching time 			
Protection class to EN 60529		Depending on connection block			
Temperature range	Operation	[°C]	–5 ... +50		
	Storage/transport	[°C]	–20 ... +70		
Materials		Reinforced PA, PC			
Grid dimension	[mm]	50			
Dimensions (incl. interlinking block and connection block) W x L x H	[mm]	50 x 107 x 50			
Weight	[g]	38			

Terminal CPX

Technical data – Input module, digital

Connection and display components

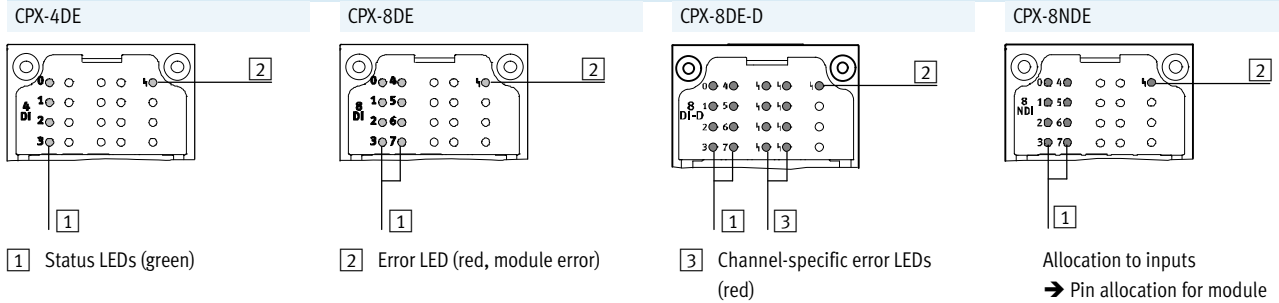

Connection block/digital input module combinations

Connection blocks	Part No.	Digital input modules			
		CPX-4DE	CPX-8DE	CPX-8DE-D	CPX-8NDE
CPX-AB-8-M8-3POL	195706	■	■	■	■
CPX-AB-4-M12X2-5POL	195704	■	■	■	■
CPX-AB-4-M12X2-5POL-R	541254	■	■	■	■
CPX-AB-8-KL-4POL	195708	■	■	■	■
CPX-AB-1-SUB-BU-25POL	525676	■	■	■	■
CPX-AB-4-HAR-4POL	525636	■	■	■	■
CPX-M-AB-4-M12x2-5POL	549367	■	■	■	■

Pin allocation

Connection block inputs	CPX-4DE	CPX-8DE, CPX-8DE-D and CPX-8NDE		
CPX-AB-8-M8-3POL	<p>X1.1: 24 V_{SEN} X1.3: 0 V_{SEN} X1.4: Input x</p> <p>X2.1: 24 V_{SEN} X2.3: 0 V_{SEN} X2.4: Input x+1</p> <p>X3.1: 24 V_{SEN} X3.3: 0 V_{SEN} X3.4: Input x+1</p> <p>X4.1: 24 V_{SEN} X4.3: 0 V_{SEN} X4.4: n.c.</p>	<p>X5.1: 24 V_{SEN} X5.3: 0 V_{SEN} X5.4: Input x+2</p> <p>X6.1: 24 V_{SEN} X6.3: 0 V_{SEN} X6.4: Input x+3</p> <p>X7.1: 24 V_{SEN} X7.3: 0 V_{SEN} X7.4: Input x+3</p> <p>X8.1: 24 V_{SEN} X8.3: 0 V_{SEN} X8.4: n.c.</p>	<p>X1.1: 24 V_{SEN} x X1.3: 0 V_{SEN} x X1.4: Input x</p> <p>X2.1: 24 V_{SEN} x+1 X2.3: 0 V_{SEN} x+1 X2.4: Input x+1</p> <p>X3.1: 24 V_{SEN} x+2 X3.3: 0 V_{SEN} x+2 X3.4: Input x+2</p> <p>X4.1: 24 V_{SEN} x+3 X4.3: 0 V_{SEN} x+3 X4.4: Input x+3</p>	<p>X5.1: 24 V_{SEN} x+4 X5.3: 0 V_{SEN} x+4 X5.4: Input x+4</p> <p>X6.1: 24 V_{SEN} x+5 X6.3: 0 V_{SEN} x+5 X6.4: Input x+5</p> <p>X7.1: 24 V_{SEN} x+6 X7.3: 0 V_{SEN} x+6 X7.4: Input x+6</p> <p>X8.1: 24 V_{SEN} x+7 X8.3: 0 V_{SEN} x+7 X8.4: Input x+7</p>
CPX-AB-4-M12X2-5POL, CPX-AB-4-M12X2-5POL-R ¹⁾ and CPX-M-AB-4-M12X2-5POL	<p>X1.1: 24 V_{SEN} X1.2: Input x+1 X1.3: 0 V_{SEN} X1.4: Input x X1.5: FE</p> <p>X2.1: 24 V_{SEN} X2.2: n.c. X2.3: 0 V_{SEN} X2.4: Input x+1 X2.5: FE</p>	<p>X3.1: 24 V_{SEN} X3.2: Input x+3 X3.3: 0 V_{SEN} X3.4: Input x+2 X3.5: FE</p> <p>X4.1: 24 V_{SEN} X4.2: n.c. X4.3: 0 V_{SEN} X4.4: Input x+3 X4.5: FE</p>	<p>X1.1: 24 V_{SEN} x X1.2: Input x+1 X1.3: 0 V_{SEN} x X1.4: Input x X1.5: FE</p> <p>X2.1: 24 V_{SEN} x+2 X2.2: Input x+3 X2.3: 0 V_{SEN} x+2 X2.4: Input x+2 X2.5: FE</p>	<p>X3.1: 24 V_{SEN} x+4 X3.2: Input x+5 X3.3: 0 V_{SEN} x+4 X3.4: Input x+4 X3.5: FE</p> <p>X4.1: 24 V_{SEN} x+6 X4.2: Input x+7 X4.3: 0 V_{SEN} x+6 X4.4: Input x+6 X4.5: FE</p>

1) Speedcon quick lock, screening additionally on metal thread

Terminal CPX

Technical data – Input module, digital





Pin allocation				
Connection block inputs		CPX-4DE		CPX-8DE, CPX-8DE-D and CPX-8NDE
CPX-AB-8-KL-4POL				
	X1.0: 24 V _{SEN}	X5.0: 24 V _{SEN}	X1.0: 24 V _{SEN x}	X5.0: 24 V _{SEN x+4}
	X1.1: 0 V _{SEN}	X5.1: 0 V _{SEN}	X1.1: 0 V _{SEN x}	X5.1: 0 V _{SEN x+4}
	X1.2: Input x	X5.2: Input x+2	X1.2: Input x	X5.2: Input x+4
	X1.3: FE	X5.3: FE	X1.3: FE	X5.3: FE
	X2.0: 24 V _{SEN}	X6.0: 24 V _{SEN}	X2.0: 24 V _{SEN x+1}	X6.0: 24 V _{SEN x+5}
	X2.1: 0 V _{SEN}	X6.1: 0 V _{SEN}	X2.1: 0 V _{SEN x+1}	X6.1: 0 V _{SEN x+5}
	X2.2: Input x+1	X6.2: Input x+3	X2.2: Input x+1	X6.2: Input x+5
	X2.3: FE	X6.3: FE	X2.3: FE	X6.3: FE
	X3.0: 24 V _{SEN}	X7.0: 24 V _{SEN}	X3.0: 24 V _{SEN x+2}	X7.0: 24 V _{SEN x+6}
	X3.1: 0 V _{SEN}	X7.1: 0 V _{SEN}	X3.1: 0 V _{SEN x+2}	X7.1: 0 V _{SEN x+6}
	X3.2: Input x+1	X7.2: Input x+3	X3.2: Input x+2	X7.2: Input x+6
	X3.3: FE	X7.3: FE	X3.3: FE	X7.3: FE
	X4.0: 24 V _{SEN}	X8.0: 24 V _{SEN}	X4.0: 24 V _{SEN x+3}	X8.0: 24 V _{SEN x+7}
	X4.1: 0 V _{SEN}	X8.1: 0 V _{SEN}	X4.1: 0 V _{SEN x+3}	X8.1: 0 V _{SEN x+7}
	X4.2: n.c.	X8.2: n.c.	X4.2: Input x+3	X8.2: Input x+7
	X4.3: FE	X8.3: FE	X4.3: FE	X8.3: FE
CPX-AB-1-SUB-BU-25POL				
	1: Input x	14: Input x+2	1: Input x	14: Input x+4
	2: Input x+1	15: Input x+3	2: Input x+1	15: Input x+5
	3: Input x+1	16: Input x+3	3: Input x+2	16: Input x+6
	4: n.c.	17: n.c.	4: Input x+3	17: Input x+7
	5: 24 V _{SEN}	18: 24 V _{SEN}	5: 24 V _{SEN x+1}	18: 24 V _{SEN x+4}
	6: 0 V _{SEN}	19: 24 V _{SEN}	6: 0 V _{SEN x+1}	19: 24 V _{SEN x+5}
	7: 24 V _{SEN}	20: 24 V _{SEN}	7: 24 V _{SEN x+3}	20: 24 V _{SEN x+6}
	8: 0 V _{SEN}	21: 24 V _{SEN}	8: 0 V _{SEN x+3}	21: 24 V _{SEN x+7}
	9: 24 V _{SEN}	22: 0 V _{SEN}	9: 24 V _{SEN x}	22: 0 V _{SEN x+2 and 3}
	10: 24 V _{SEN}	23: 0 V _{SEN}	10: 24 V _{SEN x+2}	23: 0 V _{SEN x+2 and 3}
	11: 0 V _{SEN}	24: 0 V _{SEN}	11: 0 V _{SEN x}	24: 0 V _{SEN x+2 and 3}
	12: 0 V _{SEN}	25: FE	12: 0 V _{SEN x+2}	25: FE
	13: FE	Housing: FE	13: FE	Housing: FE
CPX-AB-4-HAR-4POL				
	X1.1: 24 V _{SEN}	X3.1: 24 V _{SEN}	X1.1: 24 V _{SEN x}	X3.1: 24 V _{SEN x+4}
	X1.2: Input x+1	X3.2: Input x+3	X1.2: Input x+1	X3.2: Input x+5
	X1.3: 0 V _{SEN}	X3.3: 0 V _{SEN}	X1.3: 0 V _{SEN x}	X3.3: 0 V _{SEN x+4}
	X1.4: Input x	X3.4: Input x+2	X1.4: Input x	X3.4: Input x+4
	X2.1: 24 V _{SEN}	X4.1: 24 V _{SEN}	X2.1: 24 V _{SEN x+2}	X4.1: 24 V _{SEN x+6}
	X2.2: n.c.	X4.2: n.c.	X2.2: Input x+3	X4.2: Input x+7
	X2.3: 0 V _{SEN}	X4.3: 0 V _{SEN}	X2.3: 0 V _{SEN x+2}	X4.3: 0 V _{SEN x+6}
	X2.4: Input x+1	X4.4: Input x+3	X2.4: Input x+2	X4.4: Input x+6

Terminal CPX

Accessories – Input module, digital

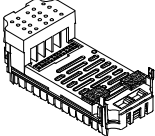
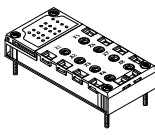
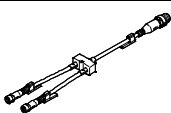
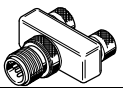
FESTO

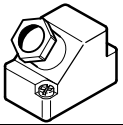
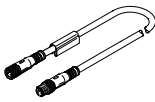
Ordering data					
Designation			Part No.	Type	
Input module, digital					
	4 digital inputs, positive logic (PNP)		195752	CPX-4DE	
	8 digital inputs, positive logic (PNP)		195750	CPX-8DE	
	8 digital inputs, positive logic (PNP), advanced diagnostic function		541480	CPX-8DE-D	
	8 digital inputs, negative logic (NPN)		543813	CPX-8NDE	
Connection block					
	Plastic	8x socket, M8, 3-pin	195706	CPX-AB-8-M8-3POL	
		4x socket, M12, 5-pin	195704	CPX-AB-4-M12X2-5POL	
		4x socket, M12 with quick-lock technology, 5-pin	541254	CPX-AB-4-M12X2-5POL-R	
		Spring clip terminal, 32-pin	195708	CPX-AB-8-KL-4POL	
		1x Sub-D socket, 25-pin	525676	CPX-AB-1-SUB-BU-25POL	
		4x socket, quick connection, 4-pin	525636	CPX-AB-4-HAR-4POL	
	Metal	4x socket, M12, 5-pin	549367	CPX-M-AB-4-M12X2-5POL	
Distributor					
	Modular system for sensor/actuator distributor		–	NEDY-... → Internet: nedy	
	Plug M12, 4-pin	2x socket M8, 3-pin	8005311	NEDY-L2R1-V1-M8G3-N-M12G4	
		2x socket M12, 5-pin	8005310	NEDY-L2R1-V1-M12G5-N-M12G4	
Plug					
	Plug	M8, 3-pin	solderable	18696	SEA-GS-M8
			screw-in	192009	SEA-3GS-M8-S
		M12, 4-pin, PG7	18666	SEA-GS-7	
		M12, PG7, 4-pin for cable Ø 2.5 mm	192008	SEA-4GS-7-2,5	
		M12, 4-pin, PG9	18778	SEA-GS-9	
		M12, 4 pin for 2 cables	18779	SEA-GS-11-DUO	
		M12 for 2 cables, 5-pin	192010	SEA-5GS-11-DUO	
	HARAX plug, 4-pin	M12, 5-pin	175487	SEA-M12-5GS-PG7	
			525928	SEA-GS-HAR-4POL	
	Sub-D plug, 25-pin		527522	SD-SUB-D-ST25	
Connecting cable					
	Connecting cable M8-M8	0.5 m	541346	NEBU-M8G3-K-0.5-M8G3	
		1.0 m	541347	NEBU-M8G3-K-1-M8G3	
		2.5 m	541348	NEBU-M8G3-K-2.5-M8G3	
		5.0 m	541349	NEBU-M8G3-K-5-M8G3	
	Modular system for connecting cables		–	NEBU-... → Internet: nebu	

Terminal CPX

Accessories – Input module, digital

FESTO

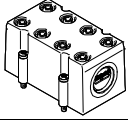
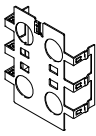
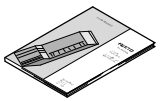
Ordering data				
Designation		Part No.	Type	
Cover				
	Cover for CPX-AB-8-KL-4POL (IP65, IP67) – 8 cable through-feeds M9 – 1 cable through-feed for multi-pin plug	538219	AK-8KL	
	Fittings kit	538220	VG-K-M9	
Screening plate				
	Screening plate for M12 connections	526184	CPX-AB-S-4-M12	
User manual				
	User manual	German	526439	P.BE-CPX-EA-DE
		English	526440	P.BE-CPX-EA-EN
		Spanish	526441	P.BE-CPX-EA-ES
		French	526442	P.BE-CPX-EA-FR
		Italian	526443	P.BE-CPX-EA-IT

Terminal CPX

Technical data – PROFI-safe input module

Function

The PROFI-safe input module has 8 input channels whose signal status is detected for safety-reasons, with the information transmitted to a suitable safety controller using the PROFI-safe safety protocol in combination with the appropriate fieldbus (PROFINET or PROFIBUS). This function is exclusively available for safety controllers using the PROFI-safe protocol, profile version 2.4.

Scope of application

- Input module for 24 V DC sensor supply voltage
- Supports connection blocks with M12 and terminal connection
- Module features can be parameterised
- Input module receives the voltage supply for the electronics and the sensors from the interlinking block
- Module protection and diagnostics through integrated electronic fuse protection



Description

Module-based passivation	Channel-by-channel passivation
While channel-by-channel passivation is disabled, the input module, in accordance with PROFI-safe specification, switches all information	<p>in the input image to the safe status, even when there is only one channel error.</p> <p>In the case of channel-by-channel passivation, when a channel error occurs, the input module switches the input information of the affected channel pair to 0, depending on the function mode.</p> <ul style="list-style-type: none"> • The input information for unaffected channel pairs does not change. • The input module remains integrated. • The input module indicates the current channel error status to the control unit via the input image.

Applications

The inputs on the PROFI-safe input module can be combined for multi-channel sensor applications. Every two inputs form a channel pair, which is set separately with one of 11 function modes.	The function mode has an influence on the evaluation of the input signals, and optionally on the generation of clock signals.	There are five independent clock outputs available for safe operation of passive sensors; the pulse patterns are used in some operating modes to detect crossovers in the signal paths.	The input module is designed to ensure that the input channels provide either secure data or no data at all, even when a fault is present in the system.
---	---	---	--

Range of applications

<ul style="list-style-type: none"> • Use as an input module for a higher-order safety controller. Several input modules can be used together and these monitor mutually independent sensors 	<ul style="list-style-type: none"> • Use of multi-channel sensor applications with up to 8 secure inputs, which can be grouped and are suitable for configuration with the help of 11 different function modes 	<ul style="list-style-type: none"> • Connection of different switches and sensors within the safety chain • Output of an identifier coded by DIL switch in the connection block CPX-AB-ID-P 	<p> Note</p> <p>The safety integrity level, Performance Level and category for the system as a whole correspond to that of the component in the safety chain with the lowest characteristic value.</p>
--	---	---	---

Application examples

<ul style="list-style-type: none"> • Two-hand circuit for starting a function • Emergency stop switch for incidents 	<ul style="list-style-type: none"> • Operating mode selector switch with four positions • Rotary indexing table 	<ul style="list-style-type: none"> • Light curtain • Acknowledge button with request 	<ul style="list-style-type: none"> • End-position switches • Protective door with two NO switches
---	---	--	---

Terminal CPX

Technical data – PROFIsafe input module

FESTO

General technical data			
Type		CPX-F8DE-P	
Number of inputs		8	
Safety function		Reliable detection and evaluation of input statuses	
Max. address capacity	Inputs	[byte]	6
	Outputs	[byte]	7
Max. cable length		[m]	200
Max. power supply	Per module	[A]	3
Current consumption of module		[mA]	Typ. 35 (power supply for electronics)
Operating voltage	Nominal value	[V DC]	24
	Permissible range	[V DC]	20.4 ... 28.8
Voltage drop per channel		[V]	0.6
Residual ripple		[Vss]	2 within voltage range
Electrical isolation	Channel – channel	No	
Input characteristic		To IEC 61131-2, type 2	
Switching logic	Inputs	PNP (positive switching)	
Safety integrity level	As per EN62061	Reliable detection and evaluation of input statuses up to SIL CL3	
	As per EN61508	Reliable detection and evaluation of input statuses up to SIL3	
Performance Level	As per ISO13849	Reliable detection and evaluation of input statuses up to Cat 4 and PL e	
Failure rate per hour (PFH)		1.0x 10 ⁻⁹	
Certificate issuing authority		01/205/5444.00/15	
LED displays	Group diagnostics	1	
	Channel diagnostics	8	
	Channel status	8	
	Failsafe protocol active	1	
Diagnostics		<ul style="list-style-type: none"> • Short circuit per channel • Undervoltage • Overvoltage • Excessive temperature • Crossover per channel • Wire break per channel • Communication • Process data error • Self test 	
Control elements		DIL switches	
Degree of protection to EN 60529		Depending on connection block	
Grid dimension		[mm]	50
Dimensions (incl. interlinking block and connection block) W x L x H		[mm]	50 x 107 x 55

Terminal CPX

Technical data – PROFIsafe input module

Materials	
Note on materials	RoHS compliant

Operating and environmental conditions		
Ambient temperature	[°C]	-5 ... +50
Storage temperature	[°C]	-20 ... +70
CE marking (see declaration of conformity)		To EC Machinery Directive
Approval certificate		c UL us Recognised (OL)

Connection and display components

CPX-F8DE-P

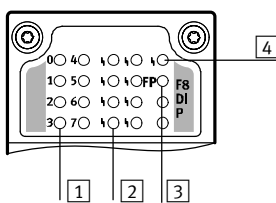

- 1 Channel-related status LEDs (green):
- 2 Channel-related error LEDs (red)
- 3 Fail-safe protocol active (green)
- 4 Error LED (red, module error)

Combinations of bus nodes/control blocks with PROFIsafe input module		
Bus node/control block	Part No.	PROFIsafe input module
		CPX-F8DE-P
CPX-FB13	195740	■
CPX-FB33	548755	■
CPX-M-FB34	548751	■
CPX-M-FB35	548749	■



Note

The PROFIsafe input module CPX-F8DE-P can only be interfaced as of software release 21 or release 30 (in the case of CPX-FB13).

Terminal CPX

Technical data – PROFIsafe input module

Connection block/PROFIsafe input module combinations		
Connection blocks	Part No.	PROFIsafe input module
		CPX-F8DE-P
CPX-M-AB-4-M12X2-5POL	549367	■
CPX-M-AB-4-M12X2-5POL-T	2639560	■
CPX-AB-8-KL-4POL	195708	■
CPX-AB-ID-P	2639571	■

Pin allocation		
Connection block inputs	CPX-F8DE-P	
CPX-M-AB-4-M12X2-5POL		
<p>X1 X3</p> <p>X2 X4</p>	<p>X1.1: 24 V_{SEN} X1.2: Input x+1 X1.3: 0 V_{SEN} X1.4: Input x X1.5: FE</p> <p>X2.1: 24 V_{SEN} X2.2: Input x+3 X2.3: 0 V_{SEN} X2.4: Input x+2 X2.5: FE</p>	<p>X3.1: 24 V_{SEN} X3.2: Input x+5 X3.3: 0 V_{SEN} X3.4: Input x+4 X3.5: FE</p> <p>X4.1: 24 V_{SEN} X4.2: Input x+7 X4.3: 0 V_{SEN} X4.4: Input x+6 X4.5: FE</p>
CPX-M-AB-4-M12X2-5POL-T		
<p>X1-T X3-T</p> <p>X2-T X4-T</p>	<p>X1-T.1: 24 V_{SEN x} X1-T.2: Input x+1 X1-T.3: 0 V_{SEN} X1-T.4: Input x X1-T.5: 24 V_{SEN x+1}</p> <p>X2-T.1: 24 V_{SEN x+2} X2-T.2: Input x+3 X2-T.3: 0 V_{SEN} X2-T.4: Input x+2 X2-T.5: 24 V_{SEN x+3}</p>	<p>X3-T.1: 24 V_{SEN x+4} X3-T.2: Input x+5 X3-T.3: 0 V_{SEN} X3-T.4: Input x+4 X3-T.5: 24 V_{SEN x+5}</p> <p>X4-T.1: 24 V_{SEN x+6} X4-T.2: Input x+7 X4-T.3: 0 V_{SEN} X4-T.4: Input x+6 X4-T.5: 24 V_{SEN x+7}</p>
CPX-AB-8-KL-4POL		
<p>X1 X5</p> <p>X2 X6</p> <p>X3 X7</p> <p>X4 X8</p>	<p>X1.0: 24 V_{SEN} X1.1: 0 V_{SEN} X1.2: Input x X1.3: FE</p> <p>X2.0: 24 V_{SEN x} X2.1: 24 V_{SEN x+1} X2.2: Input x+1 X2.3: FE</p> <p>X3.0: 24 V_{SEN} X3.1: 0 V_{SEN} X3.2: Input x+2 X3.3: FE</p> <p>X4.0: 24 V_{SEN x+2} X4.1: 24 V_{SEN x+3} X4.2: Input x+3 X4.3: FE</p>	<p>X5.0: 24 V_{SEN} X5.1: 0 V_{SEN} X5.2: Input x+4 X5.3: FE</p> <p>X6.0: 24 V_{SEN x+4} X6.1: 24 V_{SEN x+5} X6.2: Input x+5 X6.3: FE</p> <p>X7.0: 24 V_{SEN} X7.1: 0 V_{SEN} X7.2: Input x+6 X7.3: FE</p> <p>X8.0: 24 V_{SEN x+6} X8.1: 24 V_{SEN x+7} X8.2: Input x+7 X8.3: FE</p>

Terminal CPX



Technical data – PROFIsafe input module

Interlinking block/PROFIsafe input module combinations		
Interlinking blocks	Part No.	PROFIsafe input module
		CPX-F8DE-P
CPX-GE-EV-S	195746	-
CPX-GE-EV-S-7/8-4POL	541248	-
CPX-GE-EV-S-7/8-5POL	541244	-
CPX-M-GE-EV-S-7/8-CIP-4P	568956	■
CPX-M-GE-EV-S-7/8-5POL	550208	■
CPX-M-GE-EV-S-PP-5POL	563057	■
CPX-GE-EV	195742	-
CPX-M-GE-EV	550206	■
CPX-M-GE-EV-FVO	567806	-
CPX-GE-EV-Z	195744	-
CPX-GE-EV-Z-7/8-4POL	541250	-
CPX-GE-EV-Z-7/8-5POL	541246	-
CPX-M-GE-EV-Z-7/8-5POL	550210	■
CPX-M-GE-EV-Z-PP-5POL	563058	■
CPX-GE-EV-V	533577	-
CPX-GE-EV-V-7/8-4POL	541252	-

Terminal CPX

Accessories – PROFIsafe input module

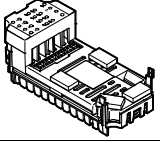
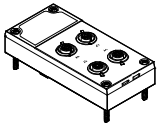
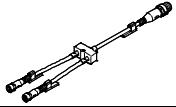
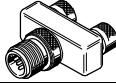
FESTO

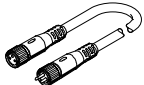
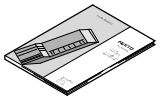
Ordering data					
Description		Part No.	Type		
PROFIsafe input module					
	8 digital inputs, positive logic (PNP), for reliable detection and evaluation of input statuses		2597424	CPX-F8DE-P	
Connection block					
	Polymer	Spring-loaded terminal, 32-pin	195708	CPX-AB-8-KL-4POL	
		8-way DIL switch	2639571	CPX-AB-ID-P	
	Metal	4x socket M12, 5-pin	Unclocked sensor supply	549367	CPX-M-AB-4-M12X2-5POL
			Clocked sensor supply	2639560	CPX-M-AB-4-M12X2-5POL-T
Distributor					
	Modular system for sensor/actuator distributor		–	NEDY-... → Internet: nedy	
	Plug M12, 4-pin	2x socket M12, 5-pin	8005310	NEDY-L2R1-V1-M12G5-N-M12G4	
Plug connector					
	Plug connector	M12, PG7	18666	SEA-GS-7	
		M12, PG7, 4-pin for cable Ø 2.5mm	192008	SEA-4GS-7-2,5	
		M12, PG9	18778	SEA-GS-9	
		M12 for 2 cables	18779	SEA-GS-11-DUO	
		M12 for 2 cables, 5-pin	192010	SEA-5GS-11-DUO	
		M12, 5-pin	175487	SEA-M12-5GS-PG7	
Connecting cable					
	Modular system for all types of connecting cable		–	NEBU-... → Internet: nebu	
User documentation					
	User documentation for PROFIsafe input module	German	8035496	P.BE-CPX-F8DE-P-DE	
		English	8035497	P.BE-CPX-F8DE-P-EN	
		Spanish	8035498	P.BE-CPX-F8DE-P-ES	
		French	8035499	P.BE-CPX-F8DE-P-FR	
		Italian	8035500	P.BE-CPX-F8DE-P-IT	
		Chinese	8035501	P.BE-CPX-F8DE-P-ZH	

Terminal CPX

Technical data – Input module, digital, 16 inputs

Function

Digital input modules enable the connection of two-wire and three-wire sensors (proximity sensors, inductive or capacitive sensors, etc.). Depending on the connection block selected, the module supports various connection concepts with different numbers of sockets (single or double allocation).

Application

- Input modules for 24 V DC sensor supply voltage
- PNP logic
- Module features can be parameterised
- The input module receives the voltage supply for the electronics and the sensors from the interlinking block
- Module protection and diagnostics through integrated electronic fuse protection

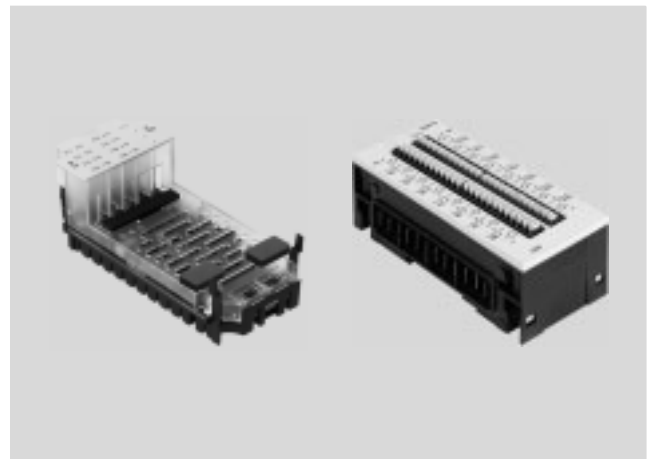

General technical data				
Type		CPX-16DE	CPX-M-16DE-D	CPX-L-16DE
Number of inputs		16	16	16
Max. residual current of inputs per module	[A]	1.8	1.8	1.8
Intrinsic current consumption at operating voltage	[mA]	Typically 15	Typically 34	Typically 15
Fuse protection		Internal electronic fuse per module	Internal electronic fuse per channel pair, additional safety fuse	Internal electronic fuse per module
Nominal operating voltage	[V DC]	24	24	24
Operating voltage range	[V DC]	18 ... 30	18 ... 30	18 ... 30
Electrical isolation	Channel – channel	No	No	No
	Channel – internal bus	No	No	No
Switching level	Signal 0	[V DC] ≤ 5	≤ 5	≤ 5
	Signal 1	[V DC] ≥ 11	≥ 11	≥ 15
Input debounce time	[ms]	3 (0.1 ms, 10 ms, 20 ms parameterisable)		
Input characteristic		IEC 1131-T2	IEC 1131-T2	IEC 1131-T2, type 01
Switching logic		Positive logic (PNP)	Positive logic (PNP)	Positive logic (PNP)
LED displays	Group diagnostics	1	1	1
	Channel diagnostics	–	16	–
	Channel status	16	16	16
Diagnostics		Short circuit/overload per channel		
Parameterisation		<ul style="list-style-type: none"> • Module monitoring • Behaviour after short circuit • Input debounce time • Signal extension time 		
Protection class to EN 60529		Depending on connection block	Depending on connection block	IP20
Temperature range	Operation	[°C] –5 ... +50	–5 ... +50	–5 ... +50
	Storage/transport	[°C] –20 ... +70	–20 ... +70	–20 ... +70
Materials		Reinforced PA, PC	Reinforced PA, PC	Reinforced PA
Note on materials		–	–	RoHS-compliant
Grid dimension	[mm]	50	50	50
Dimensions (incl. interlinking block and connection block) W x L x H	[mm]	50 x 107 x 50	50 x 107 x 50	50 x 107 x 41
Product weight	[g]	38	38	Approx. 170

Terminal CPX

Technical data – Input module, digital, 16 inputs

Connection and display components

CPX-16DE

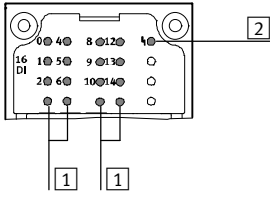

- 1 Status LEDs (green)
For allocation to inputs
→ pin allocation for module
- 2 Error LED (red, module error)

CPX-M-16DE-D

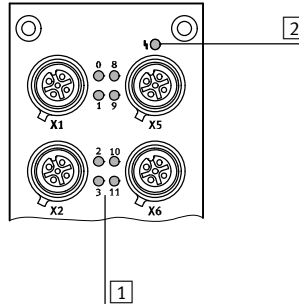

- 1 Common status LEDs (green)/error LEDs (red) for each input signal
- 2 Error LED (red, module error)

CPX-L-16DE

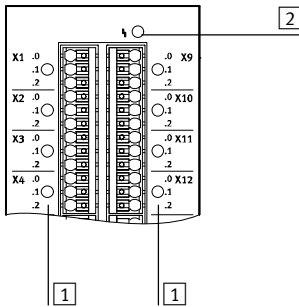

- 1 Status LEDs (green) for each input signal
- 2 Error LED (red, module error)

Connection block/digital input module combinations

Connection blocks	Part No.	Digital input modules		
		CPX-16DE	CPX-M-16DE-D	CPX-L-16DE
CPX-AB-8-M8X2-4POL	541256	■	–	–
CPX-AB-8-M12X2-5POL	3606900	–	■	–
CPX-AB-8-KL-4POL	195708	■	–	–
CPX-AB-1-SUB-BU-25POL	525676	■	–	–
CPX-M-AB-8-M12X2-5POL	549335	–	■	–

Terminal CPX

Technical data – Input module, digital, 16 inputs

Pin allocation		
Connection block inputs	CPX-16DE	
CPX-AB-8-M8x2-4POL		
	<p>X1.1: 24 V_{SEN} X1.2: Input x+1 X1.3: 0 V_{SEN} X1.4: Input x</p> <p>X2.1: 24 V_{SEN} X2.2: Input x+3 X2.3: 0 V_{SEN} X2.4: Input x+2</p> <p>X3.1: 24 V_{SEN} X3.2: Input x+5 X3.3: 0 V_{SEN} X3.4: Input x+4</p> <p>X4.1: 24 V_{SEN} X4.2: Input x+7 X4.3: 0 V_{SEN} X4.4: Input x+6</p>	<p>X5.1: 24 V_{SEN} X5.2: Input x+9 X5.3: 0 V_{SEN} X5.4: Input x+8</p> <p>X6.1: 24 V_{SEN} X6.2: Input x+11 X6.3: 0 V_{SEN} X6.4: Input x+10</p> <p>X7.1: 24 V_{SEN} X7.2: Input x+13 X7.3: 0 V_{SEN} X7.4: Input x+12</p> <p>X8.1: 24 V_{SEN} X8.2: Input x+15 X8.3: 0 V_{SEN} X8.4: Input x+14</p>
CPX-AB-8-KL-4POL		
	<p>X1.0: Input x+8 X1.1: 24 V_{SEN} X1.2: Input x X1.3: FE</p> <p>X2.0: Input x+9 X2.1: 24 V_{SEN} X2.2: Input x+1 X2.3: FE</p> <p>X3.0: Input x+10 X3.1: 24 V_{SEN} X3.2: Input x+2 X3.3: FE</p> <p>X4.0: Input x+11 X4.1: 24 V_{SEN} X4.2: Input x+3 X4.3: FE</p>	<p>X5.0: Input x+12 X5.1: 0 V_{SEN} X5.2: Input x+4 X5.3: FE</p> <p>X6.0: Input x+13 X6.1: 0 V_{SEN} X6.2: Input x+5 X6.3: FE</p> <p>X7.0: Input x+14 X7.1: 0 V_{SEN} X7.2: Input x+6 X7.3: FE</p> <p>X8.0: Input x+15 X8.1: 0 V_{SEN} X8.2: Input x+7 X8.3: FE</p>
CPX-AB-1-SUB-BU-25POL		
	<p>1: Input x 2: Input x+1 3: Input x+2 4: Input x+3 5: Input x+9 6: 24 V_{SEN} 7: Input x+11 8: 24 V_{SEN} 9: Input x+8 10: Input x+10 11: 24 V_{SEN} 12: 24 V_{SEN} 13: FE</p>	<p>14: Input x+4 15: Input x+5 16: Input x+6 17: Input x+7 18: Input x+12 19: Input x+13 20: Input x+14 21: Input x+15 22: 0 V_{SEN} 23: 0 V_{SEN} 24: 0 V_{SEN} 25: FE Housing: FE</p>

Terminal CPX

Technical data – Input module, digital, 16 inputs

Pin allocation		CPX-M-16DE-D	
Connection block inputs		CPX-M-16DE-D	
CPX-M-AB-8-M12X2-5POL and CPX-AB-8-M12X2-5POL			
	<p>X 1</p> <p>X 2</p> <p>X 3</p> <p>X 4</p> <p>X 5</p> <p>X 6</p> <p>X 7</p> <p>X 8</p>	<p>X1.1: $24 V_{Sx}$</p> <p>X1.2: Input x+1</p> <p>X1.3: $0 V_{Sx}$</p> <p>X1.4: Input x</p> <p>X1.5: FE</p> <p>X2.1: $24 V_{Sx+2}$</p> <p>X2.2: Input x+3</p> <p>X2.3: $0 V_{Sx+2}$</p> <p>X2.4: Input x+2</p> <p>X2.5: FE</p> <p>X3.1: $24 V_{Sx+4}$</p> <p>X3.2: Input x+5</p> <p>X3.3: $0 V_{Sx+4}$</p> <p>X3.4: Input x+4</p> <p>X3.5: FE</p> <p>X4.1: $24 V_{Sx+6}$</p> <p>X4.2: Input x+7</p> <p>X4.3: $0 V_{Sx+6}$</p> <p>X4.4: Input x+6</p> <p>X4.5: FE</p>	<p>X5.1: $24 V_{Sx+8}$</p> <p>X5.2: Input x+9</p> <p>X5.3: $0 V_{Sx+8}$</p> <p>X5.4: Input x+8</p> <p>X5.5: FE</p> <p>X6.1: $24 V_{Sx+10}$</p> <p>X6.2: Input x+11</p> <p>X6.3: $0 V_{Sx+10}$</p> <p>X6.4: Input x+10</p> <p>X6.5: FE</p> <p>X7.1: $24 V_{Sx+12}$</p> <p>X7.2: Input x+13</p> <p>X7.3: $0 V_{Sx+12}$</p> <p>X7.4: Input x+12</p> <p>X7.5: FE</p> <p>X8.1: $24 V_{Sx+14}$</p> <p>X8.2: Input x+15</p> <p>X8.3: $0 V_{Sx+14}$</p> <p>X8.4: Input x+14</p> <p>X8.5: FE</p>



Terminal CPX

Technical data – Input module, digital, 16 inputs

Pin allocation		CPX-L-16DE	
Connection block inputs			
<p>The diagram shows a vertical terminal block with 16 input channels, labeled X1 through X8. Each channel has three pins: pin 0 (top), pin 1 (middle), and pin 2 (bottom). The channels are arranged in two columns of eight. The left column contains channels X1 to X8, and the right column contains channels X9 to X16. The pins are numbered 0, 1, and 2 for each channel.</p>	<p>X1.0: 24 V_{SEN} X1.1: Input x X1.2: 0 V_{SEN}</p> <p>X2.0: 24 V_{SEN} X2.1: Input x+1 X2.2: 0 V_{SEN}</p> <p>X3.0: 24 V_{SEN} X3.1: Input x+2 X3.2: 0 V_{SEN}</p> <p>X4.0: 24 V_{SEN} X4.1: Input x+3 X4.2: 0 V_{SEN}</p> <p>X5.0: 24 V_{SEN} X5.1: Input x+4 X5.2: 0 V_{SEN}</p> <p>X6.0: 24 V_{SEN} X6.1: Input x+5 X6.2: 0 V_{SEN}</p> <p>X7.0: 24 V_{SEN} X7.1: Input x+6 X7.2: 0 V_{SEN}</p> <p>X8.0: 24 V_{SEN} X8.1: Input x+7 X8.2: 0 V_{SEN}</p>	<p>X9.0: 24 V_{SEN} X9.1: Input x+8 X9.2: 0 V_{SEN}</p> <p>X10.0: 24 V_{SEN} X10.1: Input x+9 X10.2: 0 V_{SEN}</p> <p>X11.0: 24 V_{SEN} X11.1: Input x+10 X11.2: 0 V_{SEN}</p> <p>X12.0: 24 V_{SEN} X12.1: Input x+11 X12.2: 0 V_{SEN}</p> <p>X13.0: 24 V_{SEN} X13.1: Input x+12 X13.2: 0 V_{SEN}</p> <p>X14.0: 24 V_{SEN} X14.1: Input x+13 X14.2: 0 V_{SEN}</p> <p>X15.0: 24 V_{SEN} X15.1: Input x+14 X15.2: 0 V_{SEN}</p> <p>X16.0: 24 V_{SEN} X16.1: Input x+15 X16.2: 0 V_{SEN}</p>	

Terminal CPX

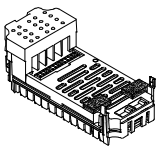
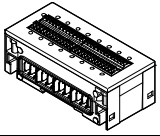
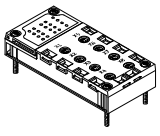
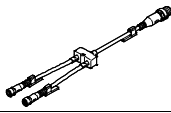
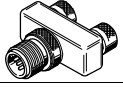
Accessories – Input module, digital, 16 inputs

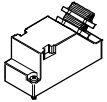
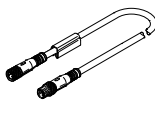
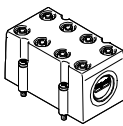
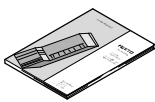
Ordering data				
Designation			Part No.	Type
Input module, digital				
	16 digital inputs, internal electronic fuse per module		543815	CPX-16DE
	16 digital inputs, internal electronic fuse per channel pair, for CPX in metal		550202	CPX-M-16DE-D
	16 digital inputs, internal electronic fuse per module, for CPX in plastic, including interlinking block and connection block with spring-loaded terminals		572606	CPX-L-16DE-16-KL-3POL
Connection block				
	Plastic	8x socket, M8, 4-pin	541256	CPX-AB-8-M8X2-4POL
		8x socket, M12, 5-pin	3606900	CPX-AB-8-M12X2-5POL
		Spring-loaded terminal, 32-pin	195708	CPX-AB-8-KL-4POL
		1x socket, Sub-D, 25-pin	525676	CPX-AB-1-SUB-BU-25POL
	Metal	8x socket, M12, 5-pin	549335	CPX-M-AB-8-M12X2-5POL
Distributor				
	Modular system for sensor/actuator distributor		–	NEDY-... → Internet: nedy
	Plug M8, 4-pin	2x socket M8, 3-pin	8005312	NEDY-L2R1-V1-M8G3-N-M8G4
Plug				
	Plug, M8, 3-pin	Solderable	18696	SEA-GS-M8
		Screw-in	192009	SEA-3GS-M8-S
	Plug, Sub-D, 25-pin		527522	SD-SUB-D-ST25
Connecting cable				
	Connecting cable M8-M8		0.5 m	541346 NEBU-M8G3-K-0.5-M8G3
			1.0 m	541347 NEBU-M8G3-K-1-M8G3
			2.5 m	541348 NEBU-M8G3-K-2.5-M8G3
			5.0 m	541349 NEBU-M8G3-K-5-M8G3
	Modular system for connecting cables		–	NEBU-... → Internet: nebu
Cover				
	Cover for CPX-AB-8-KL-4POL (IP65, IP67) – 8 cable through-feeds M9 – 1 cable through-feed for multi-pin plug		538219	AK-8KL
	Fittings kit		538220	VG-K-M9
Manual				
	Manual		German	526439 P.BE-CPX-EA-DE
			English	526440 P.BE-CPX-EA-EN
			Spanish	526441 P.BE-CPX-EA-ES
			French	526442 P.BE-CPX-EA-FR
			Italian	526443 P.BE-CPX-EA-IT

Terminal CPX

Technical data – Output module, digital

Function

Digital outputs control actuators such as individual valves, hydraulic valves, heating controllers and many more. Separate circuits are created using an additional power supply. Parallel connection of the outputs of a module enables consuming devices to be controlled with up to 4 A.

Applications

- Output module for 24 V DC supply voltage
- PNP logic
- Module features can be parameterised
- The output module receives the voltage supply for the electronics and the outputs from the interlinking block
- Module protection and diagnostics through integrated electronic fuse protection in each channel



General technical data				CPX-4DA	CPX-8DA	CPX-8DA-H
Type						
No. of outputs			4	8	8	
Max. power supply	Per module	[A]	4			8.4
	Per channel	[A]	1 (24 W lamp load, 4 channels can be connected in parallel)	0.5 (12 W lamp load, 8 channels can be connected in parallel)	2.1 (50 W lamp load), per channel pair	
Fuse protection (short circuit)			Internal electronic fuse for each channel			
Module current consumption (voltage supply for electronics)		[mA]	Typically 16			Typically 34
Operating voltage	Nominal value	[V DC]	24			
	Permissible range	[V DC]	18 ... 30			
Electrical isolation	Channel – channel		No			
	Channel – internal bus		Yes, using an intermediate supply			
Output characteristic curve			To IEC 1131-2			
Switching logic			Positive logic (PNP)			
LED displays	Group diagnostics		1	1	1	
	Channel diagnostics		4	8	8	
	Channel status		4	8	8	
Diagnostics			<ul style="list-style-type: none"> • Short circuit/overload, channel x • Undervoltage of outputs 			
Parameterisation			<ul style="list-style-type: none"> • Module monitoring • Behaviour after short circuit • Fail-safe channel x • Forcing channel x • Idle mode channel x 			
Protection class to EN 60529			Depending on connection block			
Temperature range	Operation	[°C]	–5 ... +50			
	Storage/transport	[°C]	–20 ... +70			
Materials			Reinforced PA, PC			
Grid dimension		[mm]	50			
Dimensions (incl. interlinking block and connection block) W x L x H		[mm]	50 x 107 x 50			
Weight		[g]	38			

Terminal CPX

Technical data – Output module, digital

Connection and display components

CPX-4DA

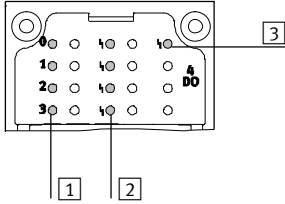

CPX-8DA

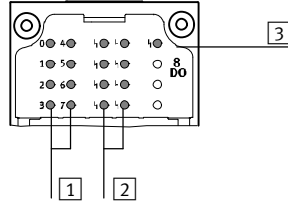

- 1 Status LEDs (yellow)
Allocation to outputs
→ Pin allocation for module
- 2 Channel-specific error LEDs (red)
- 3 Error LED (red, module error)

Connection block/digital output module combinations

Connection blocks	Part No.	Digital output module		
		CPX-4DA	CPX-8DA	CPX-8DA-H
CPX-AB-8-M8-3POL	195706	■	■	–
CPX-AB-8-M8X2-4POL	541256	■	■	■
CPX-AB-4-M12X2-5POL	195704	■	■	–
CPX-AB-4-M12X2-5POL-R	541254	■	■	■
CPX-AB-8-KL-4POL	195708	■	■	■
CPX-AB-1-SUB-BU-25POL	525676	■	■	■
CPX-AB-4-HAR-4POL	525636	■	■	–
CPX-M-AB-4-M12X2-5POL	549367	■	■	■

Pin allocation

Connection block outputs	CPX-4DA	CPX-8DA
CPX-AB-8-M8-3POL		
	X1.1: n.c. X1.3: 0 V _{OUT} X1.4: Output x X2.1: n.c. X2.3: 0 V _{OUT} X2.4: Output x+1 X3.1: n.c. X3.3: 0 V _{OUT} X3.4: Output x+1 X4.1: n.c. X4.3: 0 V _{OUT} X4.4: n.c.	X5.1: n.c. X5.3: 0 V _{OUT} X5.4: Output x+2 X6.1: n.c. X6.3: 0 V _{OUT} X6.4: Output x+3 X7.1: n.c. X7.3: 0 V _{OUT} X7.4: Output x+3 X8.1: n.c. X8.3: 0 V _{OUT} X8.4: n.c.
		X1.1: n.c. X1.3: 0 V _{OUT} X1.4: Output x X2.1: n.c. X2.3: 0 V _{OUT} X2.4: Output x+1 X3.1: n.c. X3.3: 0 V _{OUT} X3.4: Output x+2 X4.1: n.c. X4.3: 0 V _{OUT} X4.4: Output x+3
		X5.1: n.c. X5.3: 0 V _{OUT} X5.4: Output x+4 X6.1: n.c. X6.3: 0 V _{OUT} X6.4: Output x+5 X7.1: n.c. X7.3: 0 V _{OUT} X7.4: Output x+6 X8.1: n.c. X8.3: 0 V _{OUT} X8.4: Output x+7

Terminal CPX

Technical data – Output module, digital

Pin allocation					
Connection block outputs		CPX-4DA		CPX-8DA and CPX-8DA-H	
CPX-AB-8-M8X2-4POL					
		X1.1: 0 V _{OUT} X1.2: Output x+1 X1.3: 0 V _{OUT} X1.4: Output x X2.1: 0 V _{OUT} X2.2: n.c. X2.3: 0 V _{OUT} X2.4: Output x+1 X3.1: 0 V _{OUT} X3.2: Output x+3 X3.3: 0 V _{OUT} X3.4: Output x+2 X4.1: 0 V _{OUT} X4.2: n.c. X4.3: 0 V _{OUT} X4.4: Output x+3	X5.1: 0 V _{OUT} X5.2: n.c. X5.3: 0 V _{OUT} X5.4: n.c. X6.1: 0 V _{OUT} X6.2: n.c. X6.3: 0 V _{OUT} X6.4: n.c. X7.1: 0 V _{OUT} X7.2: n.c. X7.3: 0 V _{OUT} X7.4: n.c. X8.1: 0 V _{OUT} x+1 X8.2: n.c. X8.3: 0 V _{OUT} x+3 X8.4: n.c.	X1.1: 0 V _{OUT} X1.2: Output x+1 X1.3: 0 V _{OUT} X1.4: Output x X2.1: 0 V _{OUT} X2.2: Output x+3 X2.3: 0 V _{OUT} X2.4: Output x+2 X3.1: 0 V _{OUT} X3.2: Output x+5 X3.3: 0 V _{OUT} X3.4: Output x+4 X4.1: 0 V _{OUT} X4.2: Output x+7 X4.3: 0 V _{OUT} X4.4: Output x+6	X5.1: 0 V _{OUT} X5.2: n.c. X5.3: 0 V _{OUT} X5.4: n.c. X6.1: 0 V _{OUT} X6.2: n.c. X6.3: 0 V _{OUT} X6.4: n.c. X7.1: 0 V _{OUT} X7.2: n.c. X7.3: 0 V _{OUT} X7.4: n.c. X8.1: 0 V _{OUT} X8.2: n.c. X8.3: 0 V _{OUT} X8.4: n.c.
CPX-AB-4-M12X2-5POL¹⁾ and CPX-AB-4-M12X2-5POL-R²⁾					
		X1.1: n.c. X1.2: Output x+1 X1.3: 0 V _{OUT} X1.4: Output x X1.5: FE X2.1: n.c. X2.2: n.c. X2.3: 0 V _{OUT} X2.4: Output x+1 X2.5: FE	X3.1: n.c. X3.2: Output x+3 X3.3: 0 V _{OUT} X3.4: Output x+2 X3.5: FE X4.1: n.c. X4.2: n.c. X4.3: 0 V _{OUT} X4.4: Output x+3 X4.5: FE	X1.1: n.c. X1.2: Output x+1 X1.3: 0 V _{OUT} X1.4: Output x X1.5: FE X2.1: n.c. X2.2: Output x+3 X2.3: 0 V _{OUT} X2.4: Output x+2 X2.5: FE	X3.1: n.c. X3.2: Output x+5 X3.3: 0 V _{OUT} X3.4: Output x+4 X3.5: FE X4.1: n.c. X4.2: Output x+7 X4.3: 0 V _{OUT} X4.4: Output x+6 X4.5: FE
CPX-AB-8-KL-4POL					
		X1.0: n.c. X1.1: 0 V _{OUT} X1.2: Output x X1.3: FE X2.0: n.c. X2.1: 0 V _{OUT} X2.2: Output x+1 X2.3: FE X3.0: n.c. X3.1: 0 V _{OUT} X3.2: Output x+1 X3.3: FE X4.0: n.c. X4.1: 0 V _{OUT} X4.2: n.c. X4.3: FE	X5.0: n.c. X5.1: 0 V _{OUT} X5.2: Output x+2 X5.3: FE X6.0: n.c. X6.1: 0 V _{OUT} X6.2: Output x+3 X6.3: FE X7.0: n.c. X7.1: 0 V _{OUT} X7.2: Output x+3 X7.3: FE X8.0: n.c. X8.1: 0 V _{OUT} X8.2: n.c. X8.3: FE	X1.0: n.c. X1.1: 0 V _{OUT} X1.2: Output x X1.3: FE X2.0: n.c. X2.1: 0 V _{OUT} X2.2: Output x+1 X2.3: FE X3.0: n.c. X3.1: 0 V _{OUT} X3.2: Output x+2 X3.3: FE X4.0: n.c. X4.1: 0 V _{OUT} X4.2: Output x+3 X4.3: FE	X5.0: n.c. X5.1: 0 V _{OUT} X5.2: Output x+4 X5.3: FE X6.0: n.c. X6.1: 0 V _{OUT} X6.2: Output x+5 X6.3: FE X7.0: n.c. X7.1: 0 V _{OUT} X7.2: Output x+6 X7.3: FE X8.0: n.c. X8.1: 0 V _{OUT} X8.2: Output x+7 X8.3: FE

1) Not suitable for CPX-8DA-H.

2) Speedcon quick lock, screening additionally on metal thread

Terminal CPX

Technical data – Output module, digital



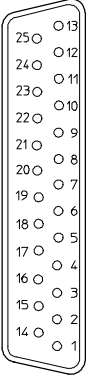
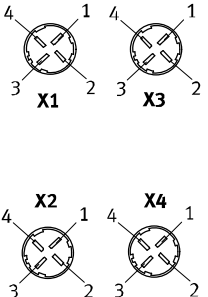

Pin allocation				
Connection block outputs	CPX-4DA		CPX-8DA and CPX-8DA-H	
CPX-AB-1-SUB-BU-25POL				
	1: Output x 2: Output x+1 3: Output x+1 4: n.c. 5: n.c. 6: 0 V _{OUT} 7: n.c. 8: 0 V _{OUT} 9: n.c. 10: n.c. 11: 0 V _{OUT} 12: 0 V _{OUT} 13: FE	14: Output x+2 15: Output x+3 16: Output x+3 17: n.c. 18: n.c. 19: n.c. 20: n.c. 21: n.c. 22: 0 V _{OUT} 23: 0 V _{OUT} 24: 0 V _{OUT} 25: FE Housing: FE	1: Output x 2: Output x+1 3: Output x+2 4: Output x+3 5: n.c. 6: 0 V _{OUT} 7: n.c. 8: 0 V _{OUT} 9: n.c. 10: n.c. 11: 0 V _{OUT} 12: 0 V _{OUT} 13: FE	14: Output x+4 15: Output x+5 16: Output x+6 17: Output x+7 18: n.c. 19: n.c. 20: n.c. 21: n.c. 22: 0 V _{OUT} 23: 0 V _{OUT} 24: 0 V _{OUT} 25: FE Housing: FE
CPX-AB-4-HAR-4POL¹⁾				
	X1.1: n.c. X1.2: Output x+1 X1.3: 0 V _{OUT} X1.4: Output x X2.1: n.c. X2.2: n.c. X2.3: 0 V _{OUT} X2.4: Output x+1	X3.1: n.c. X3.2: Output x+3 X3.3: 0 V _{OUT} X3.4: Output x+2 X4.1: n.c. X4.2: n.c. X4.3: 0 V _{OUT} X4.4: Output x+3	X1.1: n.c. X1.2: Output x+1 X1.3: 0 V _{OUT} X1.4: Output x X2.1: n.c. X2.2: Output x+3 X2.3: 0 V _{OUT} X2.4: Output x+2	X3.1: n.c. X3.2: Output x+5 X3.3: 0 V _{OUT} X3.4: Output x+4 X4.1: n.c. X4.2: Output x+7 X4.3: 0 V _{OUT} X4.4: Output x+6

1) Not suitable for CPX-8DA-H.

Terminal CPX

Accessories – Output module, digital

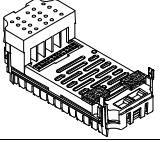
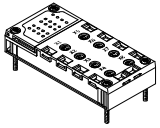
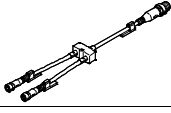
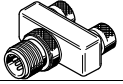
FESTO

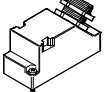
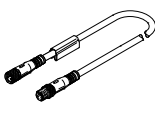
Ordering data					
Designation			Part No.	Type	
Output module, digital					
	4 digital outputs, power supply 1 A per channel		195754	CPX-4DA	
	8 digital outputs, power supply 0.5 A per channel		541482	CPX-8DA	
	8 digital outputs, power supply 2.1 A per channel pair		550204	CPX-8DA-H	
Connection block					
	Plastic	8x socket, M8, 3-pin	195706	CPX-AB-8-M8-3POL	
		8x socket, M8, 4-pin	541256	CPX-AB-8-M8X2-4POL	
		4x socket, M12, 5-pin	195704	CPX-AB-4-M12X2-5POL	
		4x socket, M12 with quick-lock technology, 5-pin	541254	CPX-AB-4-M12X2-5POL-R	
		Spring clip terminal, 32-pin	195708	CPX-AB-8-KL-4POL	
		1x Sub-D socket, 25-pin	525676	CPX-AB-1-SUB-BU-25POL	
	Metal	4x socket, quick connection, 4-pin	525636	CPX-AB-4-HAR-4POL	
4x socket, M12, 5-pin		549367	CPX-M-AB-4-M12X2-5POL		
Distributor					
	Modular system for sensor/actuator distributor		–	NEDY-... → Internet: nedy	
	Plug M8, 4-pin	2x socket M8, 3-pin	8005312	NEDY-L2R1-V1-M8G3-N-M8G4	
	Plug M12, 4-pin	2x socket M8, 3-pin	8005311	NEDY-L2R1-V1-M8G3-N-M12G4	
		2x socket M12, 5-pin	8005310	NEDY-L2R1-V1-M12G5-N-M12G4	
Plug					
	Plug	M8, 3-pin	Solderable	18696	SEA-GS-M8
			Screw-in	192009	SEA-3GS-M8-S
		M12, PG7		18666	SEA-GS-7
		M12, PG7, 4-pin for cable Ø 2.5 mm		192008	SEA-4GS-7-2,5
		M12, PG9		18778	SEA-GS-9
		M12 for 2 cables		18779	SEA-GS-11-DUO
		M12 for 2 cables, 5-pin		192010	SEA-5GS-11-DUO
	HARAX plug, 4-pin		525928	SEA-GS-HAR-4POL	
	Sub-D plug, 25-pin		527522	SD-SUB-D-ST25	
Connecting cable					
	Connecting cable M8-M8	0.5 m	541346	NEBU-M8G3-K-0.5-M8G3	
		1.0 m	541347	NEBU-M8G3-K-1-M8G3	
		2.5 m	541348	NEBU-M8G3-K-2.5-M8G3	
		5.0 m	541349	NEBU-M8G3-K-5-M8G3	
	Modular system for connecting cables			–	NEBU-... → Internet: nebu

Terminal CPX

Accessories – Output module, digital

FESTO

Ordering data					
Designation			Part No.	Type	
Cover					
	Cover for CPX-AB-8-KL-4POL (IP65, IP67)		538219	AK-8KL	
	– 8 cable through-feeds M9 – 1 cable through-feed for multi-pin plug				
	Fittings kit		538220	VG-K-M9	
Screening plate					
	Screening plate for M12 connections		526184	CPX-AB-S-4-M12	
User manual					
	User manual		German	526439	P.BE-CPX-EA-DE
			English	526440	P.BE-CPX-EA-EN
			Spanish	526441	P.BE-CPX-EA-ES
			French	526442	P.BE-CPX-EA-FR
			Italian	526443	P.BE-CPX-EA-IT

Terminal CPX

Technical data – Input/output module, digital

Application

- Digital multi I/O module for 24 V DC supply voltage
- Supports connection blocks with Sub-D, terminal connection and M12 connection (8-pin)
- As CPX-L with connection via spring-loaded terminals
- Module features can be parameterised
- The inputs receive the voltage supply for the electronics and the sensors from the interlinking block
- The outputs receive the voltage supply for the electronics and the outputs from the interlinking block
- Module protection and diagnostics through integrated electronic fuse protection for the sensor power supply and integrated electronic fuse protection in each output channel

Function

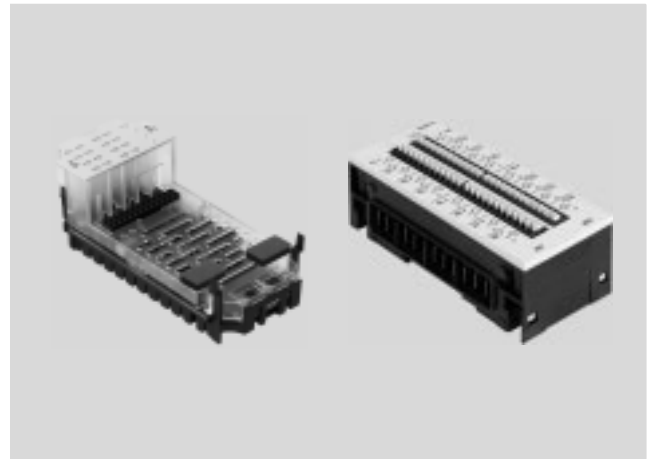
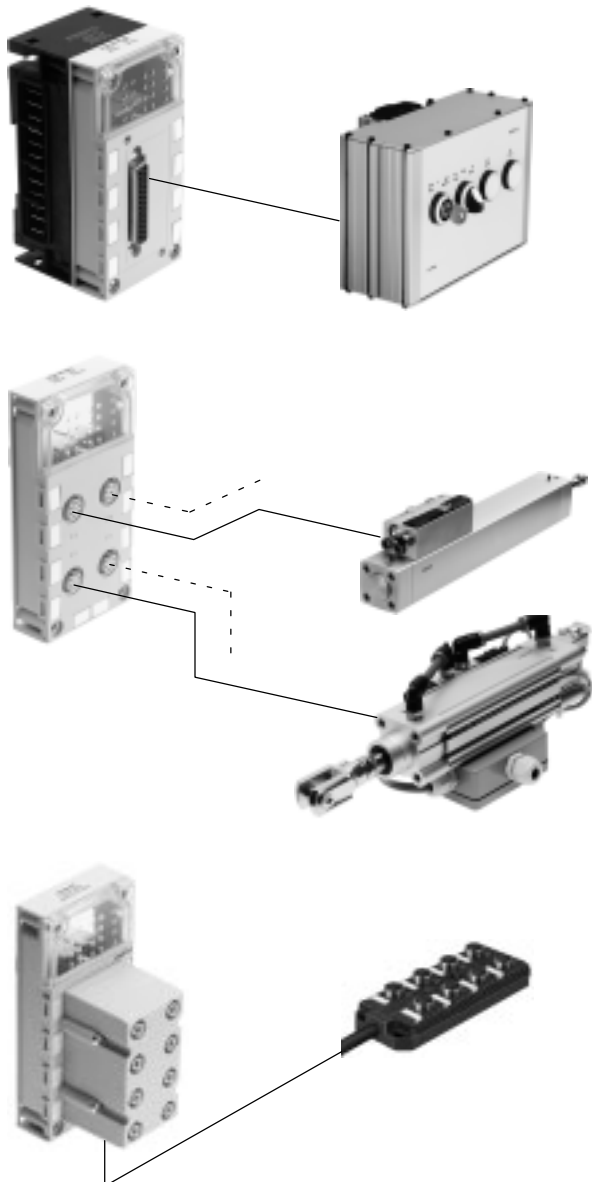

The multi I/O module controls devices with a high number of inputs and outputs per connection point. Since the module supports Sub-D connection blocks, consoles with pushbuttons and lamps can be connected to the terminal CPX using a minimal amount of installation space.

Up to 8 inputs and 8 outputs can be connected to one connection point with high protection to IP65.

Since the module supports the M12 connection block (8-pin), up to 4 cylinder/valve combinations with integrated sensors can be connected. Each cylinder/valve combination is supported by 2 inputs and 2 outputs per connection. It is therefore possible to control max. 2 solenoid coils and record signals from 2 sensors with a pre-assembled connecting cable.

Two inputs on 2 connections are bridged to provide support for the diagnostic module of the cylinder/valve combination. This means that 3 inputs and 2 outputs are available at 2 connections.

As an alternative to the Sub-D and M12 connection block (8-pin) for installation with high protection to IP65, the terminal connection block produces an identical result for installation with IP20 protection – or with IP65/IP67 protection with additional cover.

Subordinate I/O modules with multi-pin plug connection (Sub-D plug or multi-pin connecting cable for self-assembly) support the cost-effective and space-saving integration of critical installation areas such as energy chains or upstream functions.

Terminal CPX

Technical data – Input/output module, digital

FESTO

General technical data			
Type		CPX-8DE-8DA	CPX-L-8DE-8DA
Number	Inputs	8	8
	Outputs	8	8
Max. power supply per module	Sensor supply [A]	0.7	1.8
	Outputs [A]	4	2
Max. power supply per channel		[A]	0.5 (12 W lamp load, channels 00 ... 003 can be connected in parallel to 04 ... 07)
Fuse protection (short circuit)		Internal electronic fuse per channel	
Intrinsic current consumption at nominal operating voltage		[mA]	Typically 22
Operating voltage	Nominal value [V DC]	24	24
	Permissible range [V DC]	18 ... 30	18 ... 30
Electrical isolation, inputs	Channel – channel	No	No
	Channel – internal bus	No	No
Electrical isolation, outputs	Channel – channel	No	No
	Channel – internal bus	Yes, using an intermediate supply	No
Characteristic	Inputs	IEC 1131-T2	IEC 1131-T2, type 01
	Outputs	IEC 1131-T2	IEC 1131-T2
Switching level, inputs	Signal 0 [V DC]	≤ 5	≤ 5
	Signal 1 [V DC]	≥ 11	≥ 15
Input debounce time		[ms]	3 (0.1 ms, 10 ms, 20 ms parameterisable)
Switching logic		Positive logic (PNP)	Positive logic (PNP)
LED displays	Group diagnostics	1	1
	Channel diagnostics	–	–
	Channel status	16	16
Diagnostics		<ul style="list-style-type: none"> • Short circuit/overload per channel • Undervoltage at outputs 	
Parameterisation		<ul style="list-style-type: none"> • Input debounce time • Failsafe per channel • Forces per channel • Idle mode per channel • Signal extension time • Module monitoring • Behaviour after short circuit 	
Protection class to EN 60529		Depending on connection block	IP20
Temperature range	Operation [°C]	–5 ... +50	–5 ... +50
	Storage/transport [°C]	–20 ... +70	–20 ... +70
Materials		Reinforced PA, PC	Reinforced PA
Note on materials		–	RoHS-compliant
Grid dimension		[mm]	50
Dimensions (incl. interlinking block and connection block)		[mm]	50 x 107 x 50
W x L x H			50 x 107 x 41
Product weight		[g]	38
			Approx. 170

Terminal CPX

Technical data – Input/output module, digital

Connection and display components

CPX-8DE-8DA

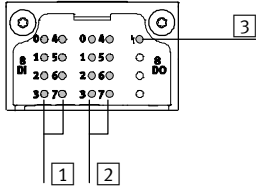

- 1 Status LEDs (green)
For allocation to inputs
→ pin allocation for module
- 2 Status LEDs (yellow)
For allocation to outputs
→ pin allocation for module
- 3 Error LED (red)
(module error)

CPX-L-8DE-8DA

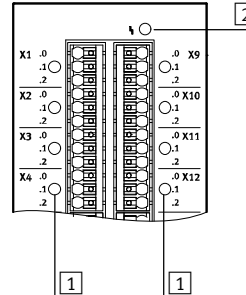

- 1 Status LEDs (green)
for each input signal
- 2 Error LED (red, module error)

Connection block/digital I/O module combinations

Connection blocks	Part No.	Digital I/O module	
		CPX-8DE-8DA	CPX-L-8DE-8DA
CPX-AB-4-M12-8POL	526178	■	–
CPX-AB-8-KL-4POL	195708	■	–
CPX-AB-1-SUB-BU-25POL	525676	■	–

Pin allocation

Connection block inputs/outputs

CPX-8DE-8DA

CPX-AB-4-M12-8POL

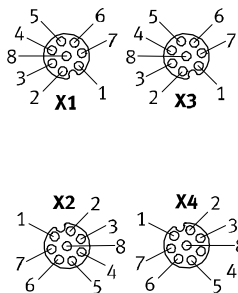

- X1.1: 24 V_{SEN}
- X1.2: Input x
- X1.3: Input x+1
- X1.4: 0 V_{SEN}
- X1.5: Output x
- X1.6: Output x+1
- X1.7: Input x+4
- X1.8: 0 V_{OUT}
- X2.1: 24 V_{SEN}
- X2.2: Input x+2
- X2.3: Input x+3
- X2.4: 0 V_{SEN}
- X2.5: Output x+2
- X2.6: Output x+3
- X2.7: Input x+6
- X2.8: 0 V_{OUT}

- X3.1: 24 V_{SEN}
- X3.2: Input x+4
- X3.3: Input x+5
- X3.4: 0 V_{SEN}
- X3.5: Output x+4
- X3.6: Output x+5
- X3.7: n.c.
- X3.8: 0 V_{OUT}
- X4.1: 24 V_{SEN}
- X4.2: Input x+6
- X4.3: Input x+7
- X4.4: 0 V_{SEN}
- X4.5: Output x+6
- X4.6: Output x+7
- X4.7: n.c.
- X4.8: 0 V_{OUT}

Terminal CPX

Technical data – Input/output module, digital

Pin allocation																																	
Connection block inputs/outputs	CPX-8DE-8DA																																
CPX-AB-8-KL-4POL																																	
	<table border="0"> <tr> <td>X1.0: 24 V_{SEN}</td> <td>X5.0: Output x+4</td> </tr> <tr> <td>X1.1: 0 V_{SEN}</td> <td>X5.1: 0 V_{OUT}</td> </tr> <tr> <td>X1.2: Input x</td> <td>X5.2: Output x</td> </tr> <tr> <td>X1.3: FE</td> <td>X5.3: FE</td> </tr> <tr> <td>X2.0: Input x+4</td> <td>X6.0: Output x+5</td> </tr> <tr> <td>X2.1: Input x+5</td> <td>X6.1: 0 V_{OUT}</td> </tr> <tr> <td>X2.2: Input x+1</td> <td>X6.2: Output x+1</td> </tr> <tr> <td>X2.3: FE</td> <td>X6.3: FE</td> </tr> <tr> <td>X3.0: 24 V_{SEN}</td> <td>X7.0: Output x+6</td> </tr> <tr> <td>X3.1: 0 V_{SEN}</td> <td>X7.1: 0 V_{OUT}</td> </tr> <tr> <td>X3.2: Input x+2</td> <td>X7.2: Output x+2</td> </tr> <tr> <td>X3.3: FE</td> <td>X7.3: FE</td> </tr> <tr> <td>X4.0: Input x+6</td> <td>X8.0: Output x+7</td> </tr> <tr> <td>X4.1: Input x+7</td> <td>X8.1: 0 V_{OUT}</td> </tr> <tr> <td>X4.2: Input x+3</td> <td>X8.2: Output x+3</td> </tr> <tr> <td>X4.3: FE</td> <td>X8.3: FE</td> </tr> </table>	X1.0: 24 V _{SEN}	X5.0: Output x+4	X1.1: 0 V _{SEN}	X5.1: 0 V _{OUT}	X1.2: Input x	X5.2: Output x	X1.3: FE	X5.3: FE	X2.0: Input x+4	X6.0: Output x+5	X2.1: Input x+5	X6.1: 0 V _{OUT}	X2.2: Input x+1	X6.2: Output x+1	X2.3: FE	X6.3: FE	X3.0: 24 V _{SEN}	X7.0: Output x+6	X3.1: 0 V _{SEN}	X7.1: 0 V _{OUT}	X3.2: Input x+2	X7.2: Output x+2	X3.3: FE	X7.3: FE	X4.0: Input x+6	X8.0: Output x+7	X4.1: Input x+7	X8.1: 0 V _{OUT}	X4.2: Input x+3	X8.2: Output x+3	X4.3: FE	X8.3: FE
X1.0: 24 V _{SEN}	X5.0: Output x+4																																
X1.1: 0 V _{SEN}	X5.1: 0 V _{OUT}																																
X1.2: Input x	X5.2: Output x																																
X1.3: FE	X5.3: FE																																
X2.0: Input x+4	X6.0: Output x+5																																
X2.1: Input x+5	X6.1: 0 V _{OUT}																																
X2.2: Input x+1	X6.2: Output x+1																																
X2.3: FE	X6.3: FE																																
X3.0: 24 V _{SEN}	X7.0: Output x+6																																
X3.1: 0 V _{SEN}	X7.1: 0 V _{OUT}																																
X3.2: Input x+2	X7.2: Output x+2																																
X3.3: FE	X7.3: FE																																
X4.0: Input x+6	X8.0: Output x+7																																
X4.1: Input x+7	X8.1: 0 V _{OUT}																																
X4.2: Input x+3	X8.2: Output x+3																																
X4.3: FE	X8.3: FE																																
CPX-AB-1-SUB-BU-25POL																																	
	<table border="0"> <tr> <td>1: Input x</td> <td>14: Output x</td> </tr> <tr> <td>2: Input x+1</td> <td>15: Output x+1</td> </tr> <tr> <td>3: Input x+2</td> <td>16: Output x+2</td> </tr> <tr> <td>4: Input x+3</td> <td>17: Output x+3</td> </tr> <tr> <td>5: Input x+4</td> <td>18: Output x+4</td> </tr> <tr> <td>6: Input x+5</td> <td>19: Output x+5</td> </tr> <tr> <td>7: Input x+6</td> <td>20: Output x+6</td> </tr> <tr> <td>8: Input x+7</td> <td>21: Output x+7</td> </tr> <tr> <td>9: 24 V_{SEN}</td> <td>22: 0 V_{OUT}</td> </tr> <tr> <td>10: 24 V_{SEN}</td> <td>23: 0 V_{OUT}</td> </tr> <tr> <td>11: 0 V_{SEN}</td> <td>24: 0 V_{OUT}</td> </tr> <tr> <td>12: 0 V_{SEN}</td> <td>25: FE</td> </tr> <tr> <td>13: FE</td> <td>Housing: FE</td> </tr> </table>	1: Input x	14: Output x	2: Input x+1	15: Output x+1	3: Input x+2	16: Output x+2	4: Input x+3	17: Output x+3	5: Input x+4	18: Output x+4	6: Input x+5	19: Output x+5	7: Input x+6	20: Output x+6	8: Input x+7	21: Output x+7	9: 24 V _{SEN}	22: 0 V _{OUT}	10: 24 V _{SEN}	23: 0 V _{OUT}	11: 0 V _{SEN}	24: 0 V _{OUT}	12: 0 V _{SEN}	25: FE	13: FE	Housing: FE						
1: Input x	14: Output x																																
2: Input x+1	15: Output x+1																																
3: Input x+2	16: Output x+2																																
4: Input x+3	17: Output x+3																																
5: Input x+4	18: Output x+4																																
6: Input x+5	19: Output x+5																																
7: Input x+6	20: Output x+6																																
8: Input x+7	21: Output x+7																																
9: 24 V _{SEN}	22: 0 V _{OUT}																																
10: 24 V _{SEN}	23: 0 V _{OUT}																																
11: 0 V _{SEN}	24: 0 V _{OUT}																																
12: 0 V _{SEN}	25: FE																																
13: FE	Housing: FE																																

Terminal CPX

Technical data – Input/output module, digital

Pin allocation		
Connection block inputs	CPX-L-8DE-8DA	
<p>The diagram shows a terminal block with 8 input channels, labeled X1 through X8. Each channel has three pins: pin 0 (top), pin .1 (middle), and pin .2 (bottom). The channels are arranged in two columns of four.</p>	<p>X1.0: 24 V_{SEN} X1.1: Input x X1.2: 0 V_{SEN+out}</p> <p>X2.0: 24 V_{SEN} X2.1: Input x+1 X2.2: 0 V_{SEN+out}</p> <p>X3.0: 24 V_{SEN} X3.1: Input x+2 X3.2: 0 V_{SEN+out}</p> <p>X4.0: 24 V_{SEN} X4.1: Input x+3 X4.2: 0 V_{SEN+out}</p> <p>X5.0: 24 V_{SEN} X5.1: Input x+4 X5.2: 0 V_{SEN+out}</p> <p>X6.0: 24 V_{SEN} X6.1: Input x+5 X6.2: 0 V_{SEN+out}</p> <p>X7.0: 24 V_{SEN} X7.1: Input x+6 X7.2: 0 V_{SEN+out}</p> <p>X8.0: 24 V_{SEN} X8.1: Input x+7 X8.2: 0 V_{SEN+out}</p>	<p>X9.0: 24 V_{SEN} X9.1: Output x X9.2: 0 V_{SEN+out}</p> <p>X10.0: 24 V_{SEN} X10.1: Output x+1 X10.2: 0 V_{SEN+out}</p> <p>X11.0: 24 V_{SEN} X11.1: Output x+2 X11.2: 0 V_{SEN+out}</p> <p>X12.0: 24 V_{SEN} X12.1: Output x+3 X12.2: 0 V_{SEN+out}</p> <p>X13.0: 24 V_{SEN} X13.1: Output x+4 X13.2: 0 V_{SEN+out}</p> <p>X14.0: 24 V_{SEN} X14.1: Output x+5 X14.2: 0 V_{SEN+out}</p> <p>X15.0: 24 V_{SEN} X15.1: Output x+6 X15.2: 0 V_{SEN+out}</p> <p>X16.0: 24 V_{SEN} X16.1: Output x+7 X16.2: 0 V_{SEN+out}</p>
Interlinking block	CPX-L-8DE-8DA	
<p>The diagram shows a vertical interlinking block with seven horizontal connection points. From top to bottom, they are labeled: 0V Valves, 24V Valves, 0V Output, 24V Output, 0V El./Sen., 24V El./Sen., and FE. A vertical line with two dots connects the 0V Output and 0V El./Sen. points.</p>	<p>The module combines the 0 V potential of the power supply for electronics and sensors with the 0 V potential of the power supply for outputs in the CPX interlinking module.</p>	<p>If all poles of the outputs of an output module connected to the right of the input/output module are to be switched off, an appropriate interlinking block with additional power supply for outputs must be used to the right of the input/output module.</p>

Terminal CPX

Accessories – Input/output module, digital

FESTO

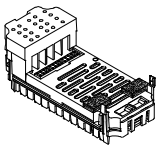
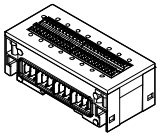
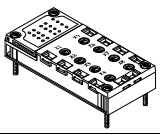
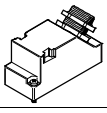
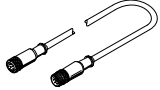
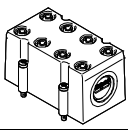
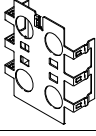
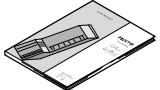
Ordering data				
Designation			Part No.	Type
Input/output module, digital				
	8 digital inputs, 8 digital outputs		526257	CPX-8DE-8DA
	8 digital inputs, 8 digital outputs, for CPX in plastic, including interlinking block and connection block with spring-loaded terminals		572607	CPX-L-8DE-8DA-16-KL-3POL
Connection block				
	Plastic	4x socket, M12, 8-pin	526178	CPX-AB-4-M12-8POL
		Spring-loaded terminal, 32-pin	195708	CPX-AB-8-KL-4POL
		1x socket, Sub-D, 25-pin	525676	CPX-AB-1-SUB-BU-25POL
Plug				
	Plug, Sub-D, 25-pin		527522	SD-SUB-D-ST25
Connecting cable				
	Connecting cable M12		525617	KM12-8GD8GS-2-PU
Cover				
	Cover for CPX-AB-8-KL-4POL (IP65, IP67) – 8 cable through-feeds M9 – 1 cable through-feed for multi-pin plug		538219	AK-8KL
	Fittings kit		538220	VG-K-M9
Screening plate				
	Screening plate for M12 connections		526184	CPX-AB-S-4-M12
Manual				
	Manual	German	526439	P.BE-CPX-EA-DE
		English	526440	P.BE-CPX-EA-EN
		Spanish	526441	P.BE-CPX-EA-ES
		French	526442	P.BE-CPX-EA-FR
		Italian	526443	P.BE-CPX-EA-IT

Terminal CPX

Technical data – Counter module, digital

Function

The counter module has two channels. Depending on the parameterisation, these can independently be used as counter inputs or as incremental value encoder inputs or SSI. The counter module additionally has one output per channel. The outputs can either be controlled by a counter channel or an incremental value encoder channel, i.e. through an event such as "Comparative value reached". Alternatively, outputs can also be controlled via process data.

Application

- Continuous counting
- One-off counting to count limit
- One-off counting to count limit, return to load value
- Periodic counting
- Measurement of frequencies
- Measurement of rotational speeds
- Measurement of duty cycle
- Measurement of position
- Measurement of speed
- Measurement with pulse generators
- Measurement with pulse generators and direction encoders
- Measurement with incremental encoders
- Measurement with SSI absolute encoders



Description

Applications

- | | | | |
|---|--|--|---|
| <ul style="list-style-type: none">• Recording travel and speed of a conveyor• Position and speed synchronisation of conveyors and pick & place applications• Counting goods e.g. in packaging installations | <ul style="list-style-type: none">• Systems for filling by weight and volume• Monitoring motor speeds• Measuring equipment for determining the position of axis systems (linear, rotational) | <ul style="list-style-type: none">• Control of fast-switching valves• Control of the opening time of a valve• Activation of semiconductor relays | <ul style="list-style-type: none">• Temperature monitoring and rotational speed control for drives• Change of direction in fast drives• Control of motors with pulse-width modulation (PWM) |
|---|--|--|---|

Supported devices

- | | | | |
|---|--|---|--|
| <ul style="list-style-type: none">• 5 V incremental encoder, single-ended or differential, with two 90° phase offset tracks | <ul style="list-style-type: none">• 24 V incremental encoder, single-ended, with two 90° phase offset tracks | <ul style="list-style-type: none">• 24 V pulse generator with or without direction level• 24 V direct current motors | <ul style="list-style-type: none">• Absolute encoder with SSI interface (13 bits to 25 bits) |
|---|--|---|--|

Terminal CPX

Technical data – Counter module, digital

FESTO

General technical data			
Type	CPX-2ZE2DA		
Number	Inputs		2
	Outputs		2
Max. power supply per module	Inputs	[A]	2
	Outputs	[A]	10
Max. power supply per channel		[A]	5 (adjustable, 20 W lamp load)
Max. cable length		[m]	30
Fuse protection (short circuit)	Internal electronic fuse per channel		
Intrinsic current consumption at nominal operating voltage		[mA]	Typically 35
Operating voltage	Nominal value	[V DC]	24
	Permissible range	[V DC]	18 ... 30
Electrical isolation, inputs	Channel – channel		No
	Channel – internal bus		No
Electrical isolation, outputs	Channel – channel		No
	Channel – internal bus		Yes, using an intermediate supply
Characteristic curve	Inputs		To IEC 1131-2, Type O2
	Outputs		IEC 1131-T2
Switching level	Signal 0	[V DC]	≤ 5
	Signal 1	[V DC]	≥ 11
Input debounce time		[μs]	0.1 (0.2 μs, 0.4 μs, 0.8 μs, 1 μs, 2 μs, 4 μs, 8 μs, 10 μs, 50 μs, 100 μs, 500 μs, 1 ms, 3 ms, 10 ms, 20 ms parameterisable)
Switching logic	Inputs		Positive logic (PNP)
	Outputs		<ul style="list-style-type: none"> • Negative logic (NPN) • Positive logic (PNP) • Push-pull driver
LED displays	Group diagnostics		1
	Channel diagnostics		2
	Channel status		10
	Module diagnostics		2
Diagnostics	Operating mode-dependent diagnostics		
Parameterisation	<ul style="list-style-type: none"> • Switch-on/off delay • Frequency output • Speed measurement • Pulse output • Pulse train • Rotational speed measurement • Frequency measurement • Duty cycle measurement • Engine operating mode • Determination of position • Pulse width modulation • One-off counting • Continuous counting • Periodic counting 		
Protection class to EN 60529	IP65, IP67		
Temperature range	Operation	[°C]	–5 ... +50
	Storage/transport	[°C]	–20 ... +70
Certification	UL - Recognized (OL)		
Housing material information	Plastic		
Note on materials	RoHS-compliant		
Grid dimension		[mm]	50
Dimensions (incl. interlinking block and connection block) W x L x H		[mm]	50 x 107 x 50
Product weight		[g]	130

Terminal CPX

Technical data – Counter module, digital

Connection and display components

CPX-2ZE2DA

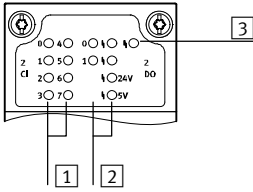

- 1 Status LEDs (green)
For allocation to inputs
→ Pin allocation for module
- 2 Status LEDs (yellow, red)
For allocation to outputs
→ Pin allocation for module
- 3 Error LED (red)
(module error)

Pin allocation		CPX-2ZE2DA	
Inputs/outputs			
		Channel 0	Channel 1
		X1.0: Input	X5.0: Input
		X1.1: Input	X5.1: Input
		X1.2: Input	X5.2: Input
		X1.3: Input	X5.3: Input
		X2.0: Input	X6.0: Input
		X2.1: Input	X6.1: Input
		X2.2: 5 V DC	X6.2: 5 V DC
		X2.3: 0 V	X6.3: 0 V
		X3.0: 24 V DC	X7.0: 24 V DC
		X3.1: 0 V	X7.1: 0 V
		X3.2: 24 V DC for digital input DI	X7.2: 24 V DC for digital input DI
		X3.3: Digital input DI	X7.3: Digital input DI
		X4.0: 0 V for digital input DI	X8.0: 0 V for digital input DI
		X4.1: Digital output DO	X8.1: Digital output DO
		X4.2: Reference potential for DO	X8.2: Reference potential for DO
		X4.3: FE	X8.3: FE



Note

The allocation and designation of inputs differs fundamentally depending on which type of encoder is connected. Appropriate allocation diagrams can be found in the user documentation for the counter module.

Terminal CPX

Accessories – Counter module, digital

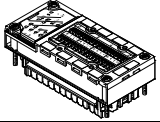
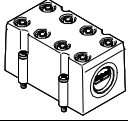
FESTO

Ordering data				
Description			Part No.	Type
Counter module, digital				
	2 digital inputs, 2 digital outputs		576046	CPX-2ZE2DA
Cover				
	Cover for CPX-2ZE2DA (IP65, IP67) – 8 cable through-feeds M9 – 1 cable through-feed for multi-pin plug		538219	AK-8KL
	Fittings kit		538220	VG-K-M9
Manual				
	Manual counter module CPX-2ZE2DA	German	8035733	P.BE-CPX-2ZE2DA-DE
		English	8035734	P.BE-CPX-2ZE2DA-EN
		Spanish	8035735	P.BE-CPX-2ZE2DA-ES
		French	8035736	P.BE-CPX-2ZE2DA-FR
		Italian	8035737	P.BE-CPX-2ZE2DA-IT
		Chinese	8035738	P.BE-CPX-2ZE2DA-ZH

Terminal CPX

Technical data HART input/output module

Function

The HART input/output module allows the connection of up to 4 sensors or actuators. The corresponding communication channel is made available for sensors or actuators that communicate using the HART protocol. With the HART protocol, a conventional analogue 4 ... 20 mA current signal is modulated by a second frequency-modulated signal. Each of the 4 connections of the module can be configured as inputs or outputs.

Area of application

- Multi I/O module for 24 V DC supply voltage
- Supports connection blocks with M12 and terminal connection
- Module features can be parameterised
- The module receives the voltage supply for the electronics, outputs and the sensors from the interlinking block
- Module protection and diagnostics through integrated electronic fuse protection



General technical data			
Type code	CPX-4AE-4AA-H		
Protocol	HART		
Number of selectable analogue inputs/outputs	4		
Sensor type	0 ... 20 mA	4 ... 20 mA	4 ... 20 mA with HART
Operating voltage	Nominal value [V DC]	24	
	Permissible range [V DC]	18 ... 30	
Power failure buffering	[ms]	10	
Intrinsic current consumption at nominal operating voltage	[mA]	Typically 170	
Maximum short circuit current	[mA]	22	
Maximum open circuit voltage	[V]	28.8	
Minimum available sensor voltage	20.7 V DC at 20 mA		
Fuse protection (short circuit)	Internal electronic fuse per channel		
Reverse polarity protection	For all electrical connections		
Electrical isolation	Channel – channel	No	
	Channel – internal bus	Yes	
Signal range	0 ... 20 mA	4 ... 20 mA	4 ... 20 mA with HART
Data format	15 bits + prefix		
	Scalable to 15 bits		
Maximum load	[Ω]	750	
Maximum input resistance	[Ω]	300	
Maximum cable length	[m]	500	
Basic error limit at 25 °C	[%]	±0.1	
Operating error limit related to the ambient temperature range	[%]	±0.3	
Repetition accuracy	0.05% at 20 °C		
LED indicators	Group diagnostics	1	
	Channel diagnostics	4	
	Channel status	4	
Control components	DIL switch		

Terminal CPX

Technical data – HART input/output module

General technical data	
Diagnostics	<ul style="list-style-type: none"> • Wire break per channel • Limit violation per channel • Short circuit/overload per channel • Parameterisation error • Overflow/underflow • Limit violation to NE43 per channel
Parameterisation	<ul style="list-style-type: none"> • Data format • Failsafe per channel • Forcing per channel • Limit monitoring per channel • Idle mode per channel • Measured value smoothing • Signal range per channel • Monitoring of overflow/underflow • Monitoring to NE43, inputs • Behaviour after short circuit/overload • Monitoring wire break per channel • Number of HART repetitions • Hysteresis for limit values • HART variables (4 pieces)
Degree of protection to EN 60529	Depending on connection block

Technical data – Mechanical	
Type of mounting	On interlinking block
Product weight	[g] 77.4
Grid dimension	[mm] 50
Dimensions (incl. interlinking block and connection block) W x L x H	[mm] 50 x 107 x 70

Materials	
Housing	PA reinforced, PC
Note on materials	RoHS-compliant

Operating and environmental conditions	
Ambient temperature	[°C] –5 ... +50
Storage temperature	[°C] –20 ... +70
Relative humidity	[%] 95, non-condensing
Corrosion resistance class CRC ¹⁾	1 (when installed)
CE marking (see declaration of conformity) ³⁾	To EU EMC Directive ²⁾

- 1) Corrosion resistance class CRC 1 to Festo standard FN 940070
Low corrosion stress. For dry indoor applications or transport and storage protection. Also applies to parts behind covers, in the non-visible interior area, and parts which are covered in the application (e.g. drive trunnions).
- 2) For information about the applicability of the component see the manufacturer's EC declaration of conformity at: www.festo.com/sp → Certificates.
If the component is subject to restrictions on usage in residential, office or commercial environments or small businesses, further measures to reduce the emitted interference may be necessary.
- 3) Additional information www.festo.com/sp → Certificates.

Safety data	
Shock resistance	Shock test with severity level 2 to FN 942017-5 and EN 60068-2-27
Vibration resistance	Transport application test with severity level 2 to FN 942017-4 and EN 60068-2-6

Terminal CPX

Technical data – HART input/output module

Connection and display components

CPX-4EA-4AA-H

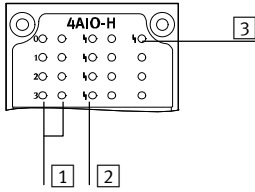

- 1** Status LEDs:
 - Inputs (green)
 - Outputs (yellow)
 - ➔ Pin allocation for module
- 2** Error LEDs (red)
 - Allocation to inputs/outputs
 - ➔ Pin allocation for module
- 3** Error LED (red)
 - (module error)

Combinations of bus nodes/control blocks with HART input/output module

Bus node/control block	Part No.	Protocol	HART input/output module
			CPX-4EA-4AA-H
CPX-FB13	195740	PROFIBUS	■
CPX-FB33	548755	PROFINET RT, M12	■
CPX-M-FB34	548751	PROFINET RT, RJ45	■
CPX-M-FB35	548749	PROFINET RT, SCRJ	■

 **Note**
 The HART input/output module CPX-4EA-4AA-H can only be connected as of software release 33 or 34 (in the case of CPX-FB13).

Combinations of connection blocks with HART input/output module

Connection blocks	Part No.	HART input/output module
		CPX-4EA-4AA-H
CPX-P-AB-4XM12-4POL	565706	■
CPX-P-AB-2XKL-8POL	565704	■

Combinations of connection blocks with interlinking block

Connection blocks	Part No.	Plastic interlinking block	Metal interlinking block
		CPX-GE...	CPX-M-GE...
CPX-P-AB-4XM12-4POL	565706	–	■
CPX-P-AB-2XKL-8POL	565704	■	■

Terminal CPX

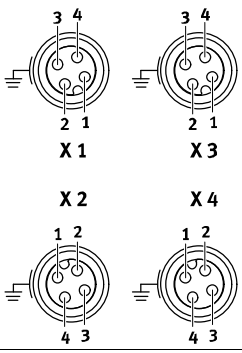
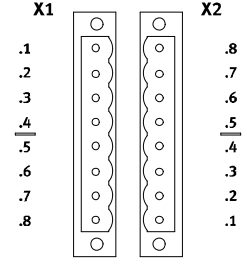

Technical data – HART input/output module

Pin allocation					
Connection block inputs/outputs		CPX-4AE-4AA-H			
		Inputs	Outputs		
CPX-P-AB-4XM12-4POL					
		X1.1: 24 V _{SEN x} X1.2: 0 V X1.3: Input x X1.4: 0 V	X3.1: 24 V _{SEN x+2} X3.2: 0 V X3.3: Input x+2 X3.4: 0 V	X1.1: Output I0+ X1.2: 0 V X1.3: – X1.4: 0 V	X3.1: Output I2+ X3.2: 0 V X3.3: – X3.4: 0 V
		X2.1: 24 V _{SEN x+1} X2.2: 0 V X2.3: Input x+1 X2.4: 0 V	X4.1: 24 V _{SEN x+3} X4.2: 0 V X4.3: Input x+3 X4.4: 0 V	X2.1: Output I1+ X2.2: 0 V X2.3: – X2.4: 0 V	X4.1: Output I3+ X4.2: 0 V X4.3: – X4.4: 0 V
CPX-P-AB-2XKL-8POL					
		X1.1: 24 V _{SEN x} X1.2: 0 V X1.3: Input x X1.4: 0 V	X2.1: 24 V _{SEN x+2} X2.2: 0 V X2.3: Input x+2 X2.4: 0 V	X1.1: Output I0+ X1.2: 0 V X1.3: – X1.4: 0 V	X2.1: Output I2+ X2.2: 0 V X2.3: – X2.4: 0 V
		X1.5: 24 V _{SEN x+1} X1.6: 0 V X1.7: Input x+1 X1.8: 0 V	X2.5: 24 V _{SEN x+3} X2.6: 0 V X2.7: Input x+3 X2.8: 0 V	X1.5: Output I1+ X1.6: 0 V X1.7: – X1.8: 0 V	X2.5: Output I3+ X2.6: 0 V X2.7: – X2.8: 0 V

 **Note**
 In the case of mixed operation of inputs and outputs in one module, the connections are first assigned input signals and then output signals, in ascending order.

Terminal CPX

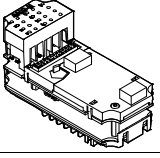
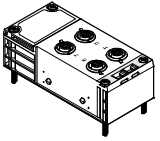
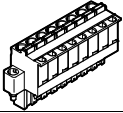
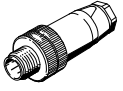
Accessories – HART input/output module

Ordering data				
Designation			Part No.	Type code
HART input/output module				
	4 analogue inputs/outputs		8059847	CPX-4AE-4AA-H
Connection block				
	Plastic	4x socket, M12, 4-pin	565706	CPX-P-AB-4XM12-4POL
		2x plug, 8-pin	565704	CPX-P-AB-2XKL-8POL
Connectors				
	8-pin socket	Spring-loaded terminal	Connection cross-section 0.2 ... 2.5 mm ²	565712 NECU-L3G8-C1
		Screw terminal	Connection cross-section 0.2 ... 2.5 mm ²	565710 NECU-L3G8-C2
	Plug M12x1, 4-pin, straight, A-coded	Insulation displacement connector	Connection cross-section 0.25 ... 0.5 mm ²	525928 SEA-GS-HAR-4POL
			Screw terminal	Connection cross-section 0.14 ... 0.5 mm ²
		Connection cross-section 0.75 mm ² Permissible cable diameter 4 ... 6 mm		18666 SEA-GS-7
		Connection cross-section 0.75 mm ² Permissible cable diameter 6 ... 8 mm		18778 SEA-GS-9
Cover				
	Cover cap for sealing unused ports M12x1 (10 pieces)		165592	ISK-M12
Coding element				
	Ensures that a coded socket NECU-L3G8 can only be inserted in the matching coded connection block CPX-P-AB-2XKL (96 pieces of each)		For NECU-L3G8	565713 CPX-P-KDS-AB-2XKL

Terminal CPX

Technical data – Analogue module for inputs

Function

Analogue modules control devices with a standardised analogue interface such as sensors for pressure, temperature, flow rate, filling level, etc.

The analogue module supports various connection concepts with different numbers of sockets or terminals as appropriate to the connection block selected.

Application

- Analogue module for 0 ... 10 V, 0 ... 20 mA or 4 ... 20 mA
- Supports connection blocks with Sub-D, terminal connection and M12 connection
- Analogue module features can be parameterised
- Different data formats available
- Operation with and without galvanic isolation possible
- The analogue module receives the voltage supply for the electronics and the sensors from the interlinking block
- Analogue module protection and diagnostics through integrated electronic fuse protection



General technical data					
Type	CPX-2AE-U-I		CPX-4AE-U-I		CPX-4AE-I
	Voltage input	Current input	Voltage input	Current input	Current input
No. of analogue inputs	2		4		4
Max. power supply per module [A]	0.7				
Fuse protection	Internal electronic fuse				
Current consumption from 24 V sensor supply (quiescent current) [mA]	Typically 50				
Current consumption from 24 V sensor supply (at full load) [A]	Max. 0.7				
Nominal operating voltage, load voltage [V DC]	24 ±2%				
Nominal operating voltage [V DC]	24				
Operating voltage range [V DC]	18 ... 30				
Signal range (parameterisable for each channel by means of DIL switch or software)	0 ... 10 V	0 ... 20 mA 4 ... 20 mA	1 ... 5 V 0 ... 10 V -5 ... +5 V -10 ... +10 V	0 ... 20 mA 4 ... 20 mA -20 ... +20 mA	0 ... 20 mA 4 ... 20 mA
Operational error limit [%]	±0.5	–	±0.3	±0.3	±0.6
Basic error limit (at 25 °C) [%]	±0.3	–	±0.2	±0.2	±0.5
Repetition accuracy (at 25 °C) [%]	0.15	0.15	0.1	0.1	0.15
Input resistance	100 kΩ	≤ 100 Ω	100 kΩ	≤ 100 Ω	≤ 100 Ω
Max. permissible input voltage [V DC]	30	–	-30 ... +30	–	–
Max. permissible input current [mA]	–	40	–	Internally limited to 60	40
Conversion time per channel [μs]	Typically 150				
Cycle time (module) [ms]	≤ 4		≤ 0.5		≤ 10
Data format	12 bit + prefix		15 bit + prefix		12 bit + prefix
	Scalable to 15 bit		Scalable to 15 bit		Scalable to 15 bit
Cable length [m]	Max. 30 (shielded)				

Terminal CPX

Technical data – Analogue module for inputs

General technical data		CPX-2AE-U-I	CPX-4AE-U-I	CPX-4AE-I
Type				
Electrical isolation	Channel – channel	No		
	Channel – internal bus	Yes, with external sensor supply		
LED displays	Group diagnostics	1		
	Channel diagnostics	Via flashing frequency of group diagnostics	4	Via flashing frequency of group diagnostics
Diagnostics		Wire break per channel		
		Limit value violation per channel		
		Parameterisation error		
		Short circuit, input signal	Overload at input	Short circuit, input signal
		–	Overflow/underflow	–
		–	Short circuit in sensor supply	–
Parameterisation		Data format		
		Forces per channel		
		Limit value monitoring per channel		
		Measured value smoothing		
		Signal range per channel		
		Wire break monitoring per channel		
		Behaviour after short circuit		
		–	Behaviour after overload at input	–
		–	Sensor supply active	–
			Depending on connection block	
Temperature range	Operation	[°C] –5 ... +50		
	Storage/transport	[°C] –20 ... +70		
Materials		Reinforced PA, PC		
Note on materials		–	RoHS-compliant	–
Grid dimension		[mm] 50		
Dimensions (incl. interlinking block and connection block) W x L x H		[mm] 50 x 107 x 50		
Product weight		38	46	38

Internal structure, basic representation

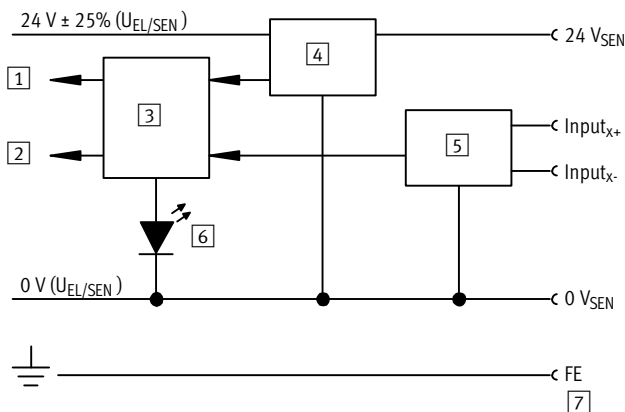

- 1 Diagnostics
- 2 Input_x
(PLC/IPC via fieldbus)
- 3 Logic
- 4 Monitoring/disconnection of the sensor supply
- 5 D/A conversion
- 6 Error LED (red, module error)
- 7 Connections on the connection block

Terminal CPX

Technical data – Analogue module for inputs

Connection and display components

CPX-2AE-U-I and CPX-4AE-I

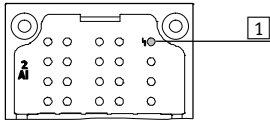

1 Error LED (red, module error)

CPX-4AE-U-I

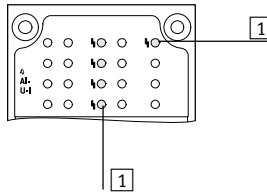

1 Error LED (red, module error)
2 Channel-related error LEDs (red)

Connection block/analogue module combinations

Connection blocks	Part No.	Analogue module		
		CPX-2AE-U-I	CPX-4AE-U-I	CPX-4AE-I
CPX-AB-4-M12X2-5POL	195704	■	■	■
CPX-AB-4-M12X2-5POL-R	541254	■	■	■
CPX-AB-8-KL-4POL	195708	■	■	■
CPX-AB-1-SUB-BU-25POL	525676	■	■	■
CPX-M-AB-4-M12X2-5POL	549367	■	■	■

Pin allocation

Connection block inputs	CPX-2AE-U-I		CPX-4AE-U-I		CPX-4AE-I		
CPX-AB-4-M12X2-5POL, CPX-AB-4-M12X2-5POL-R ¹⁾ and CPX-M-AB-4-M12X2-5POL							
	X1.1: 24 V _{SEN} X1.2: Input U0+ X1.3: 0 V _{SEN} X1.4: Input U0- X1.5: FE ²⁾	X3.1: 24 V _{SEN} X3.2: Input U1+ X3.3: 0 V _{SEN} X3.4: Input U1- X3.5: FE ²⁾	X1.1: 24 V _{SEN} X1.2: Input 0+ X1.3: 0 V _{SEN} X1.4: Input 0- X1.5: FE ²⁾	X3.1: 24 V _{SEN} X3.2: Input 2+ X3.3: 0 V _{SEN} X3.4: Input 2- X3.5: FE ²⁾	X1.1: 24 V _{SEN} X1.2: Input I0+ X1.3: 0 V _{SEN} X1.4: Input I0- X1.5: FE ²⁾	X3.1: 24 V _{SEN} X3.2: Input I2+ X3.3: 0 V _{SEN} X3.4: Input I2- X3.5: FE ²⁾	
	X2.1: 24 V _{SEN} X2.2: Input I0+ X2.3: 0 V _{SEN} X2.4: Input I0- X2.5: FE ²⁾	X4.1: 24 V _{SEN} X4.2: Input I1+ X4.3: 0 V _{SEN} X4.4: Input I1- X4.5: FE ²⁾	X2.1: 24 V _{SEN} X2.2: Input 1+ X2.3: 0 V _{SEN} X2.4: Input 1- X2.5: FE ²⁾	X4.1: 24 V _{SEN} X4.2: Input 3+ X4.3: 0 V _{SEN} X4.4: Input 3- X4.5: FE ²⁾	X2.1: 24 V _{SEN} X2.2: Input I1+ X2.3: 0 V _{SEN} X2.4: Input I1- X2.5: FE ²⁾	X4.1: 24 V _{SEN} X4.2: Input I3+ X4.3: 0 V _{SEN} X4.4: Input I3- X4.5: FE ²⁾	
CPX-AB-8-KL-4POL							
	X1.0: 24 V _{SEN} X1.1: 0 V _{SEN} X1.2: Input U0- X1.3: FE	X5.0: 24 V _{SEN} X5.1: 0 V _{SEN} X5.2: Input U1- X5.3: FE	X1.0: 24 V _{SEN} X1.1: 0 V _{SEN} X1.2: Input 0- X1.3: FE	X5.0: 24 V _{SEN} X5.1: 0 V _{SEN} X5.2: Input 2- X5.3: FE	X1.0: 24 V _{SEN} X1.1: 0 V _{SEN} X1.2: Input I0- X1.3: FE	X5.0: 24 V _{SEN} X5.1: 0 V _{SEN} X5.2: Input I2- X5.3: FE	
	X2.0: n.c. X2.1: n.c. X2.2: Input U0+ X2.3: FE	X6.0: n.c. X6.1: n.c. X6.2: Input U1+ X6.3: FE	X2.0: n.c. X2.1: n.c. X2.2: Input 0+ X2.3: FE	X6.0: n.c. X6.1: n.c. X6.2: Input 2+ X6.3: FE	X2.0: n.c. X2.1: n.c. X2.2: Input I0+ X2.3: FE	X6.0: n.c. X6.1: n.c. X6.2: Input I2+ X6.3: FE	
	X3.0: 24 V _{SEN} X3.1: 0 V _{SEN} X3.2: Input I0- X3.3: FE	X7.0: 24 V _{SEN} X7.1: 0 V _{SEN} X7.2: Input I1- X7.3: FE	X3.0: 24 V _{SEN} X3.1: 0 V _{SEN} X3.2: Input 1- X3.3: FE	X7.0: 24 V _{SEN} X7.1: 0 V _{SEN} X7.2: Input 3- X7.3: FE	X3.0: 24 V _{SEN} X3.1: 0 V _{SEN} X3.2: Input I1- X3.3: FE	X7.0: 24 V _{SEN} X7.1: 0 V _{SEN} X7.2: Input I3- X7.3: FE	
	X4.0: n.c. X4.1: n.c. X4.2: Input I0+ X4.3: FE	X8.0: n.c. X8.1: n.c. X8.2: Input I1+ X8.3: FE	X4.0: n.c. X4.1: n.c. X4.2: Input 1+ X4.3: FE	X8.0: n.c. X8.1: n.c. X8.2: Input 3+ X8.3: FE	X4.0: n.c. X4.1: n.c. X4.2: Input I1+ X4.3: FE	X8.0: n.c. X8.1: n.c. X8.2: Input I3+ X8.3: FE	

1) Speedcon quick lock, shield additionally on metal thread
2) FE/shield additionally on metal thread

Terminal CPX

Technical data – Analogue module for inputs

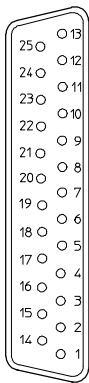
Pin allocation						
Connection block inputs	CPX-2AE-U-I	CPX-4AE-U-I	CPX-4AE-I	CPX-4AE-I	CPX-4AE-I	CPX-4AE-I
CPX-AB-1-SUB-BU-25POL						
	1: Input U0- 2: Input U0+ 3: Input I0- 4: Input I1+ 5: n.c. 6: n.c. 7: n.c. 8: n.c. 9: 24 V _{SEN} 10: 24 V _{SEN} 11: 0 V _{SEN} 12: 0 V _{SEN} 13: Shield ¹⁾	14: Input U1- 15: Input U1+ 16: Input I1- 17: Input I1+ 18: 24 V _{SEN} 19: n.c. 20: 24 V _{SEN} 21: n.c. 22: 0 V _{SEN} 23: 0 V _{SEN} 24: 0 V _{SEN} 25: FE Housing: FE	1: Input 0- 2: Input 0+ 3: Input 1- 4: Input 1+ 5: n.c. 6: n.c. 7: n.c. 8: n.c. 9: 24 V _{SEN} 10: 24 V _{SEN} 11: 0 V _{SEN} 12: 0 V _{SEN} 13: Shield ¹⁾	14: Input 2- 15: Input 2+ 16: Input 3- 17: Input 3+ 18: 24 V _{SEN} 19: n.c. 20: 24 V _{SEN} 21: n.c. 22: 0 V _{SEN} 23: 0 V _{SEN} 24: 0 V _{SEN} 25: FE Housing: FE	1: Input I0- 2: Input I0+ 3: Input I1- 4: Input I1+ 5: n.c. 6: n.c. 7: n.c. 8: n.c. 9: 24 V _{SEN} 10: 24 V _{SEN} 11: 0 V _{SEN} 12: 0 V _{SEN} 13: Shield ¹⁾	14: Input I2- 15: Input I2+ 16: Input I3- 17: Input I3+ 18: 24 V _{SEN} 19: n.c. 20: 24 V _{SEN} 21: n.c. 22: 0 V _{SEN} 23: 0 V _{SEN} 24: 0 V _{SEN} 25: FE Housing: FE

1) Connect shield to functional earth FE

Terminal CPX

Accessories – Analogue module for inputs

FESTO

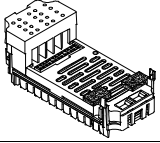
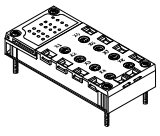
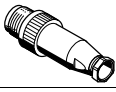
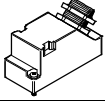
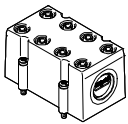
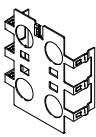
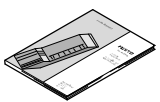
Ordering data		Part No.	Type
Input module, analogue			
	2 analogue current or voltage inputs	526168	CPX-2AE-U-I
	4 analogue current or voltage inputs	573710	CPX-4AE-U-I
	4 analogue current inputs	541484	CPX-4AE-I
Connection block			
	Plastic	4x socket, M12, 5-pin	195704 CPX-AB-4-M12X2-5POL
		4x socket, M12 with quick-lock technology, 5-pin	541254 CPX-AB-4-M12X2-5POL-R
		Spring-loaded terminal, 32-pin	195708 CPX-AB-8-KL-4POL
		1x socket, Sub-D, 25-pin	525676 CPX-AB-1-SUB-BU-25POL
	Metal	4x socket, M12, 5-pin	549367 CPX-M-AB-4-M12X2-5POL
Plug			
	Plug, M12, 5 pin	175487	SEA-M12-5GS-PG7
	Plug, Sub-D, 25-pin	527522	SD-SUB-D-ST25
Cover			
	Cover for CPX-AB-8-KL-4POL (IP65, IP67) – 8 cable through-feeds M9 – 1 cable through-feed for multi-pin plug	538219	AK-8KL
	Fittings kit	538220	VG-K-M9
Screening plate			
	Screening plate for M12 connections	526184	CPX-AB-S-4-M12
Manual			
	Manual	German	526415 P.BE-CPX-AX-DE
		English	526416 P.BE-CPX-AX-EN
		Spanish	526417 P.BE-CPX-AX-ES
		French	526418 P.BE-CPX-AX-FR
		Italian	526419 P.BE-CPX-AX-IT

Terminal CPX

Technical data – Analogue input module with pressure sensors

Function

The pressure input modules enable a maximum of four pressures to be processed. The internal measured value of the sensor (analogue value with 10 bit resolution) is converted into an internal numerical format as appropriate to the parameterisation and made available to the bus node as an image table. It is also possible to combine two channels into one differential pressure channel.

Applications

- Measuring range 0 ... 10 bar or -1 ... +1 bar
- Choice of units of measurement
- Processing of max. four pressures per module
- Pressure indication via LCD display
- Direct connection via QS4 push-in connectors
- Error message via CPX
- Channel-oriented diagnostics



General technical data				
Type		CPX-4AE-P-B2	CPX-4AE-P-D10	
No. of analogue inputs		4		
Pneumatic connection		QS-4		
Nominal operating voltage	[V DC]	24		
Operating voltage range	[V DC]	18...30		
Intrinsic current consumption	[mA]	Typically 50		
Measured variable		4x relative or 2x differential pressure measurement		
Displayable units		<ul style="list-style-type: none"> • kPa • mbar • psi 		
Pressure measuring range	Starting value	[bar]	-1	0
	Final value	[bar]	1	10
Internal cycle time	[ms]	5		
Data format		<ul style="list-style-type: none"> • 15 bits + prefix • Binary representation in mbar, kPa, psi 		
LED displays		Group diagnostics		
Diagnostics		<ul style="list-style-type: none"> • Limit value violation per channel • Parameterisation error • Sensor limit per channel 		
Parameterisation		<ul style="list-style-type: none"> • Diagnostic delay per channel • Hysteresis per module • Unit of measurement • Measured value smoothing per channel • Limit value monitoring per channel • Sensor limit per channel • Measurement of relative/differential pressure 		
Protection class to EN 60529		IP65, IP67		
Operating medium		Compressed air in accordance with ISO 8573-1:2010 [7:4:4]		
Note on operating/pilot medium		Operation with lubricated medium possible (in which case lubricated operation will always be required)		
Ambient temperature	[°C]	-5 ... 50		
Storage temperature	[°C]	-20 ... 70		
Temperature of medium	[°C]	0 ... 50		
Note on materials		RoHS-compliant		
Materials		Reinforced PA, PC		
Grid dimension	[mm]	50		
Dimensions (incl. interlinking block) W x L x H	[mm]	50 x 107 x 55		
Weight	[g]	112		



Note

Extreme pneumatic conditions, for example high cycle frequency with large pressure amplitudes, can damage the sensors.

Terminal CPX

Accessories – Analogue input module with pressure sensors

Connection and display components

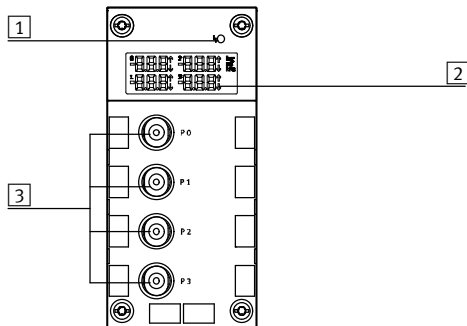

- 1 Error LED (red, module error)
- 2 LCD display with permanent display of the four measured pressures, unit of measurement and if applicable limit value violation
- 3 QS connections

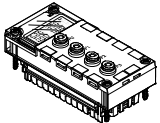
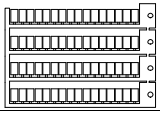
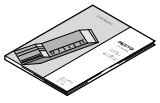
Ordering data		Part No.	Type
Designation			
Input module, analogue			
	4 analogue pressure inputs, pressure range -1 ... +1 bar	560361	CPX-4AE-P-B2
	4 analogue pressure inputs, pressure range 0 ... 10 bar	560362	CPX-4AE-P-D10
Inscription labels			
	Inscription labels 6x10, 64 pieces, in frames	18576	IBS-6x10
User manual			
	User manual	German	526415 P.BE-CPX-AX-DE
		English	526416 P.BE-CPX-AX-EN
		Spanish	526417 P.BE-CPX-AX-ES
		French	526418 P.BE-CPX-AX-FR
		Italian	526419 P.BE-CPX-AX-IT

Terminal CPX

Technical data – Analogue module for temperature inputs

Function

The CPX-PT100 analogue input module with 4 channels for temperature measurement enables the connection of up to 4 temperature sensors of the type PT100-PT1000, Ni100-Ni1000, etc. The temperature module supports various connection concepts with different numbers of sockets or terminals as appropriate to the connection block selected.

Applications

- Temperature module for temperature sensors PT100, PT200, PT500, PT1000, Ni100, Ni120, Ni500, Ni1000
- Supports connection blocks with M12, Harax and terminal connection
- Temperature module features can be parameterised
- 2-wire, 3-wire and 4-wire connection
- The temperature module is provided with voltage supply for the electronics and the sensors via the interlinking block
- Temperature module protection and diagnostics through integrated electronic fuse protection



General technical data		
Type		CPX-4AE-T
		Temperature input
No. of analogue inputs		Choice of 2 or 4
Max. power supply per module [A]		0.7
Fuse protection		Internal electronic fuse for sensor supply
Current consumption from 24 V sensor supply (quiescent current) [mA]		Typically 50
Supply voltage of sensors [V DC]		24 ±25%
Sensor type (parameterisable for each channel by means of DIL switch)		PT100, PT200, PT500, PT1000 Ni100, Ni120, Ni500, Ni1000
Temperature range	Pt standard [°C]	–200 ... +850
	Pt climatic [°C]	–120 ... +130
	Ni [°C]	–60 ... +180
Sensor connection technology		2-wire, 3-wire and 4-wire technology
Resolution		15 bit + prefix
Operating error limit relative to input range [%]		±0.06
Basic error limit (25 °C)	Standard [K]	±0.6
	Pt climatic [K]	±0.2
Temperature errors relative to input range [%]		±0.001
Linearity errors (no software scaling) [%]		±0.02
Repetition accuracy (at 25 °C) [%]		±0.05
Max. line resistance per wire [Ω]		10
Max. permissible input voltage [V]		±30
Cycle time (module) [ms]		≤ 250

Terminal CPX

Technical data – Analogue module for temperature inputs

General technical data		
Data format		15 bit + prefix, complement of two, binary notation in tenths of a degree
Cable length	[m]	Max. 200 (screened)
Electrical isolation	Channel – channel	No
	Channel – internal bus	Yes
LED displays	Group diagnostics	1
	Channel diagnostics	4
Diagnostics		<ul style="list-style-type: none"> • Short circuit/overload, channel • Parameterisation error • Value falling below nominal range/full-scale value • Value exceeding nominal range/full-scale value • Wire break
Parameterisation		<ul style="list-style-type: none"> • Unit of measurement and interference frequency suppression • Diagnostic message in the event of a wire break or short circuit • Limit monitoring per channel • Sensor connection technology • Sensor type/temperature coefficient, temperature range • Limit value per channel • Measured value smoothing
Protection class to EN 60529		Depending on connection block
Temperature range	Operation	[°C] –5 ... +50
	Storage/transport	[°C] –20 ... +70
Materials		Reinforced PA, PC
Grid dimension	[mm]	50
Dimensions (incl. interlinking block and connection block) W x L x H	[mm]	50 x 107 x 50
Weight	[g]	38

Connection and display components

CPX-4AE-T

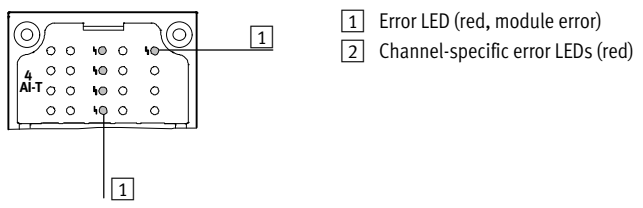

Connection block/analogue module combinations		
Connection blocks	Part No.	Temperature module
		CPX-4AE-T
CPX-AB-4-M12X2-5POL	195704	■
CPX-AB-4-M12X2-5POL-R	541254	■
CPX-AB-8-KL-4POL	195708	■
CPX-AB-4-HAR-4POL	525636	■
CPX-M-AB-4-M12X2-5POL	549367	■

Terminal CPX

Technical data – Analogue module for temperature inputs





Pin allocation		
Connection block inputs	CPX-4AE-T	
CPX-AB-4-M12X2-5POL, CPX-AB-4-M12X2-5POL-R ¹⁾ and CPX-M-AB-4-M12X2-5POL		
	<p>X1.1: Input I0+ X1.2: Input U0+ X1.3: Input I0- X1.4: Input U0- X1.5: FE²⁾</p> <p>X2.1: Input I1+ X2.2: Input U1+ X2.3: Input I1- X2.4: Input U1- X2.5: FE²⁾</p>	<p>X3.1: Input I2+ X3.2: Input U2+ X3.3: Input I2- X3.4: Input U2- X3.5: FE²⁾</p> <p>X4.1: Input I3+ X4.2: Input U3+ X4.3: Input I3- X4.4: Input U3- X4.5: FE²⁾</p>
CPX-AB-8-KL-4POL		
	<p>X1.0: Input I0+ X1.1: Input I0- X1.2: Input U0- X1.3: FE</p> <p>X2.0: n.c. X2.1: n.c. X2.2: Input U0+ X2.3: FE</p> <p>X3.0: Input I1+ X3.1: Input I1- X3.2: Input U1- X3.3: FE</p> <p>X4.0: n.c. X4.1: n.c. X4.2: Input U1+ X4.3: FE</p>	<p>X5.0: Input I2+ X5.1: Input I2- X5.2: Input U2- X5.3: FE</p> <p>X6.0: n.c. X6.1: n.c. X6.2: Input U2+ X6.3: FE</p> <p>X7.0: Input I3+ X7.1: Input I3- X7.2: Input U3- X7.3: FE</p> <p>X8.0: n.c. X8.1: n.c. X8.2: Input U3+ X8.3: FE</p>
CPX-AB-4-HAR-4POL		
	<p>X1.1: Input I0+ X1.2: Input U0+ X1.3: Input I0- X1.4: Input U0-</p> <p>X2.1: Input I1+ X2.2: Input U1+ X2.3: Input I1- X2.4: Input U1-</p>	<p>X3.1: Input I2+ X3.2: Input U2+ X3.3: Input I2- X3.4: Input U2-</p> <p>X4.1: Input I3+ X4.2: Input U3+ X4.3: Input I3- X4.4: Input U3-</p>

1) Speedcon quick lock, screening additionally on metal thread

2) FE/screening additionally on metal thread

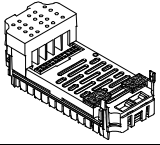
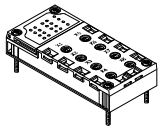
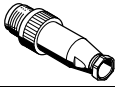
Terminal CPX

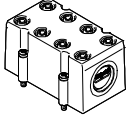
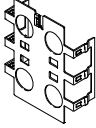
Accessories – Analogue module for temperature inputs

Ordering data			
Designation		Part No.	Type
Input module, analogue			
	2 or 4 analogue temperature inputs	541486	CPX-4AE-T
Connection block			
	Plastic	4x socket, M12, 5-pin	195704 CPX-AB-4-M12X2-5POL
		4x socket, M12 with quick-lock technology, 5-pin	541254 CPX-AB-4-M12X2-5POL-R
		Spring clip terminal, 32-pin	195708 CPX-AB-8-KL-4POL
		4x socket, quick connection, 4-pin	525636 CPX-AB-4-HAR-4POL
	Metal	4x socket, M12, 5-pin	549367 CPX-M-AB-4-M12X2-5POL
Plug			
	M12 plug, 5-pin	175487	SEA-M12-5GS-PG7
	HARAX plug, 4-pin	525928	SEA-GS-HAR-4POL
Cover			
	Cover for CPX-AB-8-KL-4POL (IP65, IP67) – 8 cable through-feeds M9 – 1 cable through-feed for multi-pin plug		538219 AK-8KL
	Fittings kit		538220 VG-K-M9
Screening plate			
	Screening plate for M12 connections	526184	CPX-AB-S-4-M12
User manual			
	User manual	German	526415 P.BE-CPX-AX-DE
		English	526416 P.BE-CPX-AX-EN
		Spanish	526417 P.BE-CPX-AX-ES
		French	526418 P.BE-CPX-AX-FR
		Italian	526419 P.BE-CPX-AX-IT

Terminal CPX

Technical data – Analogue module for thermocoupler

Function

The CPX-4AE-TC analogue input module with four channels for temperature measurement enables up to four thermocoupler sensors to be connected. The channels feature wire break and short circuit detection. If no cold junction compensation sensor is being used, an internal theoretical value of 25 °C can be used (accuracy is impaired).

Applications

- Supports connection blocks with M12 and terminal connection
- Temperature module features can be parameterised
- 2-wire connection
- 2-wire connection for a PT1000 sensor for cold junction compensation
- The temperature module is provided with voltage supply for the electronics and the sensors via the interlinking block
- Temperature module protection and diagnostics through integrated electronic fuse protection



General technical data		
Type		CPX-4AE-TC
		Temperature input
No. of analogue inputs		4
Fuse protection (short circuit)		Internal electronic fuse for each channel
Nominal operating voltage	[V DC]	24
Operating voltage range	[V DC]	18 ... 30
Sensor type (parameterisable for each channel by means of software)		<ul style="list-style-type: none"> • Type B +400 ... +1,820 °C, 8 µV/°C • Type E -270 ... +900 °C, 60 µV/°C • Type J -200 ... +1,200 °C, 51 µV/°C • Type K -200 ... +1,370 °C, 40 µV/°C • Type N -200 ... +1,300 °C, 38 µV/°C • Type R 0 ... +1,760 °C, 12 µV/°C • Type S 0 ... +1,760 °C, 11 µV/°C • Type T -200 ... +400 °C, 40 µV/°C
Sensor connection technology		2-wire technology
Operating error limit relative to ambient temperature	[%]	Max. ±0.6
Basic error limit (at 25 °C)	[%]	Max. ±0.4
Repetition accuracy (at 25 °C)	[%]	±0.05
Max. line resistance per wire	[Ω]	10
Max. residual current per module	[mA]	30
Max. permissible input voltage	[V]	±30
Internal cycle time (module)	[ms]	250

Terminal CPX

Technical data – Analogue module for thermocoupler

General technical data		
Data format		<ul style="list-style-type: none"> • 15 bit + prefix, complement of two • Binary notation in tenths of a degree
Cable length	[m]	Max. 50 (screened)
Electrical isolation	Channel – channel	No
	Channel – internal bus	Yes
LED displays	Group diagnostics	1
	Channel diagnostics	4
Diagnostics		<ul style="list-style-type: none"> • Parameterisation error • Wire break per channel • Limit value violation per channel
Parameterisation		<ul style="list-style-type: none"> • Wire break monitoring per channel • Unit of measurement • Cold junction compensation • Sensor type per channel • Limit value monitoring per channel • Measured value smoothing
Protection class to EN 60529		Depending on connection block
Temperature range	Operation	[°C] –5 ... +50
	Storage/transport	[°C] –20 ... +70
Materials		Reinforced PA, PC
Grid dimension	[mm]	50
Dimensions (incl. interlinking block and connection block) W x L x H	[mm]	50 x 107 x 50
Weight	[g]	38

Connection and display components

CPX-4AE-TC

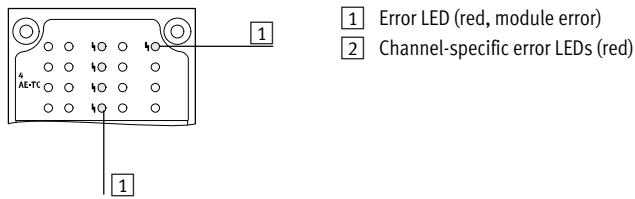

Connection block/analogue module combinations		
Connection blocks	Part No.	Temperature module
		CPX-4AE-TC
CPX-AB-4-M12X2-5POL	195704	■
CPX-AB-4-M12X2-5POL-R	541254	■
CPX-AB-8-KL-4POL	195708	■
CPX-M-AB-4-M12x2-5POL	549367	■

Terminal CPX

Technical data – Analogue module for thermocoupler

Pin allocation		
Connection block inputs	CPX-4AE-TC	
CPX-AB-4-M12X2-5POL, CPX-AB-4-M12X2-5POL-R ¹⁾ and CPX-M-AB-4-M12X2-5POL		
	<p>X1.1: Input I0+ X1.2: Input U0+ X1.3: Input I0- X1.4: Input U0- X1.5: FE²⁾</p> <p>X2.1: Input I1+ X2.2: Input U1+ X2.3: Input I1- X2.4: Input U1- X2.5: FE²⁾</p>	<p>X3.1: Input I2+ X3.2: Input U2+ X3.3: Input I2- X3.4: Input U2- X3.5: FE²⁾</p> <p>X4.1: Input I3+ X4.2: Input U3+ X4.3: Input I3- X4.4: Input U3- X4.5: FE²⁾</p>
CPX-AB-8-KL-4POL		
	<p>X1.0: Input I0+ X1.1: Input I0- X1.2: Input U0- X1.3: FE</p> <p>X2.0: n.c. X2.1: n.c. X2.2: Input U0+ X2.3: FE</p> <p>X3.0: Input I1+ X3.1: Input I1- X3.2: Input U1- X3.3: FE</p> <p>X4.0: n.c. X4.1: n.c. X4.2: Input U1+ X4.3: FE</p>	<p>X5.0: Input I2+ X5.1: Input I2- X5.2: Input U2- X5.3: FE</p> <p>X6.0: n.c. X6.1: n.c. X6.2: Input U2+ X6.3: FE</p> <p>X7.0: Input I3+ X7.1: Input I3- X7.2: Input U3- X7.3: FE</p> <p>X8.0: n.c. X8.1: n.c. X8.2: Input U3+ X8.3: FE</p>



1) Speedcon quick lock, screening additionally on metal thread

2) FE/screening additionally on metal thread

Terminal CPX

Accessories – Analogue module for thermocoupler

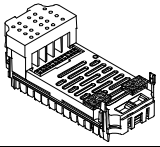
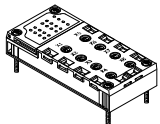
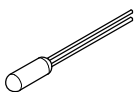
FESTO

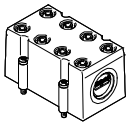
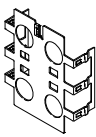
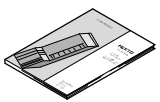
Ordering data			
Designation		Part No.	Type
Input module, analogue			
	4 analogue temperature inputs, with 2-wire connection for a PT1000 sensor for cold junction compensation	553594	CPX-4AE-TC
Connection block			
	Plastic	4x socket, M12, 5-pin	195704 CPX-AB-4-M12X2-5POL
		4x socket, M12 with quick-lock technology, 5-pin	541254 CPX-AB-4-M12X2-5POL-R
	Metal	Spring clip terminal, 32-pin	195708 CPX-AB-8-KL-4POL
		4x socket, M12, 5-pin	549367 CPX-M-AB-4-M12X2-5POL
Cold junction compensation			
	PT1000 temperature sensor for cold junction compensation	553596	CPX-W-PT1000
Plug			
	M12 plug, 5-pin	175487	SEA-M12-5GS-PG7
Cover			
	Cover for CPX-AB-8-KL-4POL (IP65, IP67) – 8 cable through-feeds M9 – 1 cable through-feed for multi-pin plug	538219	AK-8KL
	Fittings kit	538220	VG-K-M9
Screening plate			
	Screening plate for M12 connections	526184	CPX-AB-S-4-M12
User manual			
	User manual	German	526415 P.BE-CPX-AX-DE
		English	526416 P.BE-CPX-AX-EN
		Spanish	526417 P.BE-CPX-AX-ES
		French	526418 P.BE-CPX-AX-FR
		Italian	526419 P.BE-CPX-AX-IT

Terminal CPX

Technical data – Analogue module for outputs

Function

Analogue modules control devices with a standard analogue interface such as proportional valves, etc. The analogue module supports various connection concepts with different numbers of sockets or terminals as appropriate to the connection block selected.

Applications

- Analogue module for 0 ... 10 V, 0 ... 20 mA or 4 ... 20 mA
- Supports connection blocks with M12, Sub-D and terminal connection
- Analogue module features can be parameterised
- Different data formats available
- Operation with and without galvanic isolation possible
- The analogue module receives the voltage supply for the electronics and the actuators from the interlinking block
- Analogue module protection and diagnostics through integrated electronic fuse protection



General technical data				
Type		CPX-2AA-U-I		
		Voltage output	Current output	
No. of analogue outputs		2		
Max. actuator supply per module	[A]	2.8		
Fuse protection		Internal electronic fuse for actuator supply		
Current consumption from 24 V sensor supply (at full load)	[mA]	Max. 150		
Current consumption from 24 V actuator supply (at full load)	[A]	4 ... 10		
Supply voltage of actuators	[V DC]	24 ±25%		
Signal range (parameterisable for each channel by means of DIL switch or software)		0 ... 10 V DC	0 ... 20 mA 4 ... 20 mA	
Resolution	[bit]	12		
No. of units		4,096		
Absolute accuracy	[%]	±0.6		
Linearity errors (no software scaling)	[%]	±0.1		
Repetition accuracy (at 25 °C)	[%]	0.05		
Encoder selection	Load resistance for ohmic load	[kΩ]	Min. 1	Max. 0.5
	Load resistance for capacitive load	[μF]	Max. 1	–
	Load resistance for inductive load	[mH]	–	Max. 1
	Short circuit protection analogue output		Yes	–
	Short circuit current analogue output	[mA]	Approx. 20	–
	Open circuit voltage	[V DC]	–	18
	Destruction limit against externally applied voltage	[V DC]	15	
	Actuator connection		2 wires	
Cycle time (module)	[ms]	≤ 4		

Terminal CPX

Technical data – Analogue module for outputs

General technical data				
Type		CPX-2AA-U-I		
		Voltage output	Current output	
Response time	For ohmic load	[ms]	0.1	0.1
	For capacitive load	[ms]	0.7	–
	For inductive load	[ms]	–	0.5
Data format	15 bit + prefix, linear scaling 12 bit right-justified 12 bit left-justified, S7 compatible 12 bit left-justified, S5 compatible			
Cable length		[m]	Max. 30 (screened)	
LED displays	Group diagnostics		1	
	Channel diagnostics		Yes, by means of flashing frequency of group diagnostics	
Diagnostics	<ul style="list-style-type: none"> • Short circuit/overload, actuator supply • Parameterisation error • Value falling below nominal range/full-scale value • Value exceeding nominal range/full-scale value • Wire break 			
Parameterisation	<ul style="list-style-type: none"> • Short circuit monitoring, actuator supply • Short circuit monitoring, analogue output • Behaviour after short circuit, actuator supply • Data format • Lower limit value/full-scale value • Upper limit value/full-scale value • Monitoring of value falling below nominal range/full-scale value • Monitoring of value exceeding nominal range/full-scale value • Wire break monitoring • Signal range 			
Protection class to EN 60529	Depending on connection block			
Temperature range	Operation		[°C]	–5 ... +50
	Storage/transport		[°C]	–20 ... +70
Materials	Reinforced PA, PC			
Grid dimension		[mm]	50	
Dimensions (incl. interlinking block and connection block) W x L x H		[mm]	50 x 107 x 50	
Weight		[g]	38	

Connection and display components

CPX-2AA-U-I

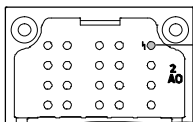

1 Error LED (red, module error)

Connection block/analogue module combinations			
Connection blocks	Part No.	Analogue module	
		CPX-2AA-U-I	
CPX-AB-4-M12X2-5POL	195704		■
CPX-AB-4-M12X2-5POL-R	541254		■
CPX-AB-8-KL-4POL	195708		■
CPX-AB-1-SUB-BU-25POL	525676		■
CPX-M-AB-4-M12X2-5POL	549367		■

Terminal CPX

Technical data – Analogue module for outputs



Pin allocation		
Connection block outputs	CPX-2AA-U-I	
CPX-AB-4-M12X2-5POL, CPX-AB-4-M12X2-5POL-R ¹⁾ and CPX-M-AB-4-M12X2-5POL		
	<p>X1.1: 24 V_{OUT} X1.2: Output U_{O+} X1.3: 0 V_{OUT} X1.4: Output GND X1.5: FE²⁾</p> <p>X2.1: 24 V_{OUT} X2.2: Output I_{O+} X2.3: 0 V_{OUT} X2.4: Output GND X2.5: FE²⁾</p>	<p>X3.1: 24 V_{OUT} X3.2: Output U_{I+} X3.3: 0 V_{OUT} X3.4: Output GND X3.5: FE²⁾</p> <p>X4.1: 24 V_{OUT} X4.2: Output I_{I+} X4.3: 0 V_{OUT} X4.4: Output GND X4.5: FE²⁾</p>
CPX-AB-8-KL-4POL		
	<p>X1.0: 24 V_{OUT} X1.1: 0 V_{OUT} X1.2: Output GND X1.3: FE</p> <p>X2.0: n.c. X2.1: n.c. X2.2: Output U_{O+} X2.3: FE</p> <p>X3.0: 24 V_{OUT} X3.1: 0 V_{OUT} X3.2: Output GND X3.3: FE</p> <p>X4.0: n.c. X4.1: n.c. X4.2: Output I_{O+} X4.3: FE</p>	<p>X5.0: 24 V_{OUT} X5.1: 0 V_{OUT} X5.2: Output GND X5.3: FE</p> <p>X6.0: n.c. X6.1: n.c. X6.2: Output U_{I+} X6.3: FE</p> <p>X7.0: 24 V_{OUT} X7.1: 0 V_{OUT} X7.2: Output GND X7.3: FE</p> <p>X8.0: n.c. X8.1: n.c. X8.2: Output I_{I+} X8.3: FE</p>
CPX-AB-1-SUB-BU-25POL		
	<p>1: Output GND 2: Output U_{O+} 3: Output GND 4: Output I_{O+} 5: n.c. 6: n.c. 7: n.c. 8: n.c. 9: 24 V_{OUT} 10: 24 V_{OUT} 11: 0 V_{OUT} 12: 0 V_{OUT} 13: Screening³⁾</p>	<p>14: Output GND 15: Output U_{I+} 16: Output GND 17: Output I_{I+} 18: 24 V_{OUT} 19: n.c. 20: 24 V_{OUT} 21: n.c. 22: 0 V_{OUT} 23: 0 V_{OUT} 24: 0 V_{OUT} 25: FE Housing: FE</p>

1) Speedcon quick lock, screening additionally on metal thread
 2) FE/screening additionally on metal thread
 3) Connect screening to functional earth FE

Terminal CPX

Accessories – Analogue module for outputs

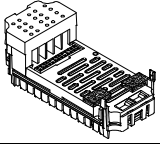
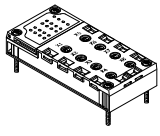
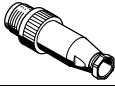
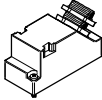
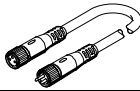
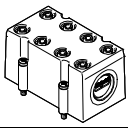
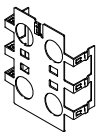
FESTO

Ordering data			
Designation		Part No.	Type
Output module, analogue			
	2 analogue current or voltage outputs	526170	CPX-2AA-U-I
Connection block			
	Plastic	4x socket, M12, 5-pin	195704 CPX-AB-4-M12X2-5POL
		4x socket, M12 with quick-lock technology, 5-pin	541254 CPX-AB-4-M12X2-5POL-R
		Spring clip terminal, 32-pin	195708 CPX-AB-8-KL-4POL
		1x Sub-D socket, 25-pin	525676 CPX-AB-1-SUB-BU-25POL
	Metal	4x socket, M12, 5-pin	549367 CPX-M-AB-4-M12X2-5POL
Plug			
	M12 plug, 5-pin	175487	SEA-M12-5GS-PG7
	Sub-D plug, 25-pin	527522	SD-SUB-D-ST25
Connecting cable			
	Modular system for connecting cables	–	NEBU-... → Internet: nebu
Cover			
	Cover for CPX-AB-8-KL-4POL (IP65, IP67) – 8 cable through-feeds M9 – 1 cable through-feed for multi-pin plug	538219	AK-8KL
	Fittings kit	538220	VG-K-M9
Screening plate			
	Screening plate for M12 connections	526184	CPX-AB-S-4-M12
User manual			
	User manual	German	526415 P.BE-CPX-AX-DE
		English	526416 P.BE-CPX-AX-EN
		Spanish	526417 P.BE-CPX-AX-ES
		French	526418 P.BE-CPX-AX-FR
		Italian	526419 P.BE-CPX-AX-IT

Terminal CPX

Technical data – PROFINsafe shut-off module

Function

The PROFINsafe shut-off module interrupts the contact rails of the interlinking block for valves and outputs. The supply voltage for valves can be switched by the module within the CPX terminal and via a connection block to two consuming devices. Actuation takes place via the fieldbus node (PROFINET) of the CPX terminal.

Scope of application

- Output module for 24 V DC supply voltage
- Shut-off module for supply voltage for valves
- Can only be used with PROFINET or PROFIBUS bus node
- The shut-off module is supplied with voltage for the electronics and the outputs by the interlinking block
- The outputs are supplied from the power supply for valves (V_{Valves})

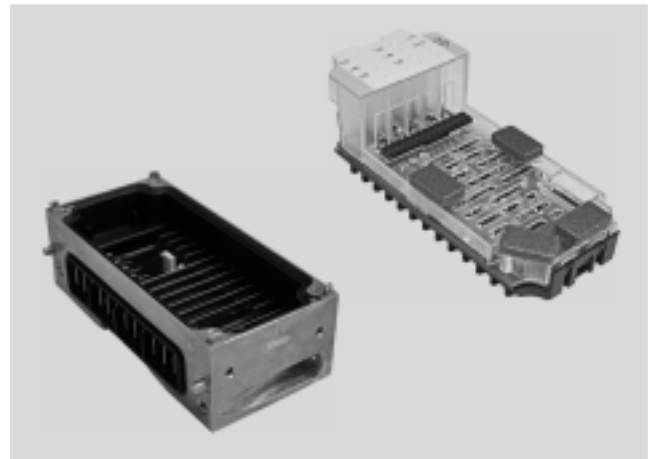

General technical data			
Type			CPX-FVDA-P2
Number of outputs			2
Note on outputs			1 internal channel for shutting off the supply voltage for valves 2 external outputs
Max. power supply	Per module	[A]	5
	Per channel	[A]	1.5
Fuse protection (short circuit)			Internal electronic fuse for each channel
Current consumption of module		[mA]	Typ. 65 (power supply for valves)
		[mA]	Typ. 25 (power supply for electronics)
Operating voltage	Nominal value	[V DC]	24
	Permissible range	[V DC]	20.4 ... 28.8
Voltage drop per channel		[V]	0.6
Residual ripple		[V _{ss}]	2 within voltage range
Load capacity to FE		[nF]	400
Max. response time to shut-off command		[ms]	23
Electrical isolation	Channel – channel		No
	Channel – internal bus		Yes, using an intermediate supply
Switching logic	Outputs		P-M switching
Safety integrity level			Safe shut off, SIL 3
Performance level			Safe shut off/category 3, performance level e
Failure rate per hour (PFH)			1.0×10^{-9}
Certificate issuing authority			01/205/50294/13
LED displays	Group diagnostics		1
	Channel diagnostics		3
	Channel status		3
	Failsafe protocol active		1
Diagnostics			<ul style="list-style-type: none"> • Short circuit/overload per channel • Undervoltage of valves • Cross circuit • Wire break per channel
Parameterisation			<ul style="list-style-type: none"> • Wire break monitoring per channel • Diagnostic behaviour
Protection class to EN 60529			Depending on connection block
Materials			PA reinforced, PC
Note on materials			RoHS-compliant
Grid dimension		[mm]	50
Dimensions (incl. interlinking block and connection block) W x L x H		[mm]	50 x 107 x 55

Terminal CPX

Technical data – PROFIsafe shut-off module

Operating and environmental conditions		
Ambient temperature	[°C]	-5 ... +50
Storage temperature	[°C]	-20 ... +70
CE mark (see declaration of conformity)		To EU Machinery Directive
Certification		c UL us - Recognized (OL)

Connection and display components

CPX-FVDA-P2

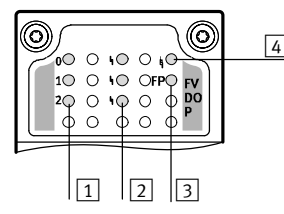

- 1 Status LEDs (yellow):
0: Supply voltage for valves
1: X1
2: X2
- 2 Channel-specific error LEDs (red)
- 3 Failsafe protocol active (green)
- 4 Error LED (red, module error)

Combinations of bus nodes/control blocks and PROFIsafe shut-off module		
Bus node/control block	Part No.	PROFIsafe shut-off module
		CPX-FVDA-P2
CPX-FB13	195740	■
CPX-FB33	548755	■
CPX-M-FB34	548751	■
CPX-M-FB35	548749	■

Note
The PROFIsafe shut-off module CPX-FVDA-P2 can only be interfaced as of software release 21 or release 30 (CPX-FB13).

Terminal CPX

Technical data – PROFIsafe shut-off module

Combinations of connection blocks and PROFIsafe shut-off module		
Connection blocks	Part No.	PROFIsafe shut-off module
		CPX-FVDA-P2
CPX-M-AB-4-M12X2-5POL	549367	■
CPX-AB-8-KL-4POL	195708	■

Pin allocation		
Connection block outputs	CPX-FVDA-P2	
CPX-M-AB-4-M12X2-5POL		
	<p>X1.1: 0 V_{OUT} 1 (cannot be shut off)</p> <p>X1.2: 24 V_{OUT} 1 (cannot be shut off)</p> <p>X1.3: 0 V_{OUT} 1 (can be shut off via fieldbus)</p> <p>X1.4: 24 V_{OUT} 1 (can be shut off via fieldbus)</p> <p>X1.5: FE (earth)</p> <p>X2.1: 0 V_{OUT} 2 (cannot be shut off)</p> <p>X2.2: 24 V_{OUT} 2 (cannot be shut off)</p> <p>X2.3: 0 V_{OUT} 2 (can be shut off via fieldbus)</p> <p>X2.4: 24 V_{OUT} 2 (can be shut off via fieldbus)</p> <p>X2.5: FE (earth)</p>	<p>X3.1: n.c.</p> <p>X3.2: n.c.</p> <p>X3.3: n.c.</p> <p>X3.4: n.c.</p> <p>X3.5: FE (earth)</p> <p>X4.1: n.c.</p> <p>X4.2: n.c.</p> <p>X4.3: n.c.</p> <p>X4.4: n.c.</p> <p>X4.5: FE (earth)</p>
CPX-AB-8-KL-4POL		
	<p>X1.0: 0 V_{OUT} 1 (cannot be shut off)</p> <p>X1.1: 0 V_{OUT} 1 (can be shut off via fieldbus)</p> <p>X1.2: 24 V_{OUT} 1 (can be shut off via fieldbus)</p> <p>X1.3: FE (earth)</p> <p>X2.0: n.c.</p> <p>X2.1: n.c.</p> <p>X2.2: 24 V_{OUT} 1 (cannot be shut off)</p> <p>X2.3: FE (earth)</p> <p>X3.0: 0 V_{OUT} 2 (cannot be shut off)</p> <p>X3.1: 0 V_{OUT} 2 (can be shut off via fieldbus)</p> <p>X3.2: 24 V_{OUT} 2 (can be shut off via fieldbus)</p> <p>X3.3: FE (earth)</p> <p>X4.0: n.c.</p> <p>X4.1: n.c.</p> <p>X4.2: 24 V_{OUT} 2 (cannot be shut off)</p> <p>X4.3: FE (earth)</p>	<p>X5.0: n.c.</p> <p>X5.1: n.c.</p> <p>X5.2: n.c.</p> <p>X5.3: n.c.</p> <p>X6.0: n.c.</p> <p>X6.1: n.c.</p> <p>X6.2: n.c.</p> <p>X6.3: n.c.</p> <p>X7.0: n.c.</p> <p>X7.1: n.c.</p> <p>X7.2: n.c.</p> <p>X7.3: n.c.</p> <p>X8.0: n.c.</p> <p>X8.1: n.c.</p> <p>X8.2: n.c.</p> <p>X8.3: n.c.</p>

Terminal CPX

Technical data – PROFIsafe shut-off module

Combinations of interlinking blocks and PROFIsafe shut-off module		
Interlinking blocks	Part No.	PROFIsafe shut-off module
		CPX-FVDA-P2
CPX-GE-EV-S	195746	–
CPX-GE-EV-S-7/8-4POL	541248	–
CPX-GE-EV-S-7/8-5POL	541244	–
CPX-M-GE-EV-S-7/8-CIP-4P	568956	–
CPX-M-GE-EV-S-7/8-5POL	550208	–
CPX-M-GE-EV-S-PP-5POL	563057	–
CPX-GE-EV	195742	–
CPX-M-GE-EV	550206	–
CPX-M-GE-EV-FVO	567806	■
CPX-GE-EV-Z	195744	–
CPX-GE-EV-Z-7/8-4POL	541250	–
CPX-GE-EV-Z-7/8-5POL	541246	–
CPX-M-GE-EV-Z-7/8-5POL	550210	–
CPX-M-GE-EV-Z-PP-5POL	563058	–
CPX-GE-EV-V	533577	–
CPX-GE-EV-V-7/8-4POL	541252	–

General technical data		
Type		CPX-M-GE-EV-FVO
Nominal operating voltage	[V DC]	24
Acceptable current load (per contact/contact rail)	[A]	16
Protection class to EN 60529		Depending on connection block
Ambient temperature	[°C]	–5 ... +50
Material declaration		RoHS-compliant
Note on materials		Die-cast aluminium
Type of mounting		Angled fitting
Grid dimension	[mm]	50
Dimensions W x L x H	[mm]	50 x 107 x 35
Product weight	[g]	170

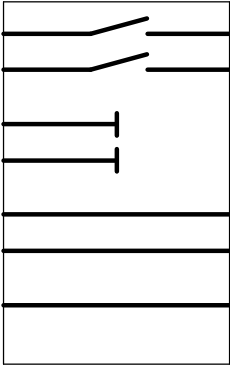
Pin allocation			
Circuitry		Pin	Allocation
	0V Valves	–	–
	24V Valves	–	–
	0V Output	–	–
	24V Output	–	–
	0V El./Sen.		
	24V El./Sen.		
	FE		

Terminal CPX

Accessories – PROFI-safe shut-off module

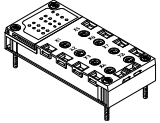
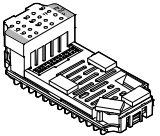
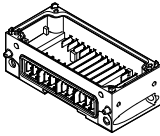
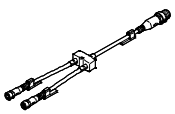
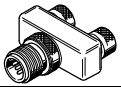
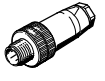
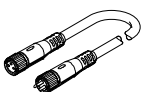
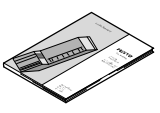

Ordering data				
	Description		Part No.	Type
PROFI-safe shut-off module				
	Metal connection block	4x socket, M12, 5-pin	549367	CPX-M-AB-4-M12X2-5POL
	Plastic connection block	Spring-loaded terminal, 32-pin	195708	CPX-AB-8-KL-4POL
	Electronics module (can only be used with CPX-M-GE-EV-FVO)	PROFINET, PROFIBUS	1971599	CPX-FVDA-P2
	Metal interlinking block (only for CPX-FVDA-P2)		567806	CPX-M-GE-EV-FVO
Distributor				
	Modular system for sensor/actuator distributor		–	NEDY-... → Internet: nedy
	Plug M12, 4-pin	2x socket M12, 5-pin	8005310	NEDY-L2R1-V1-M12G5-N-M12G4
Plug				
	Plug	M12, PG7	18666	SEA-GS-7
		M12, PG7, 4-pin for cable Ø 2.5 mm	192008	SEA-4GS-7-2,5
		M12, PG9	18778	SEA-GS-9
		M12 for 2 cables	18779	SEA-GS-11-DUO
		M12 for 2 cables, 5-pin	192010	SEA-5GS-11-DUO
		M12, 5-pin	175487	SEA-M12-5GS-PG7
Connecting cable				
	Modular system for connecting cables		–	NEBU-... → Internet: nebu
Manual				
	Manual for PROFI-safe shut-off module	German	8022606	P.BE-CPX-FVDA-P2-DE
		English	8022607	P.BE-CPX-FVDA-P2-EN
		Spanish	8022608	P.BE-CPX-FVDA-P2-ES
		French	8022609	P.BE-CPX-FVDA-P2-FR
		Italian	8022610	P.BE-CPX-FVDA-P2-IT
		Chinese	8022611	P.BE-CPX-FVDA-P2-ZH

Terminal CPX

Technical data – End plate with system power supply

Function

End plates form the outer edge of the CPX terminal.

The earth connection and mounting holes for wall or H-rail mounting are located on the left end plate.

The end plate with system power supply has contact rails from which the other CPX components on the interlinking modules are supplied with power.

Application

- 24 V DC supply voltage for the electronics of the CPX terminal
- 24 V DC supply voltage for inputs
- 24 V DC supply voltage for valves
- 24 V DC supply voltage for outputs

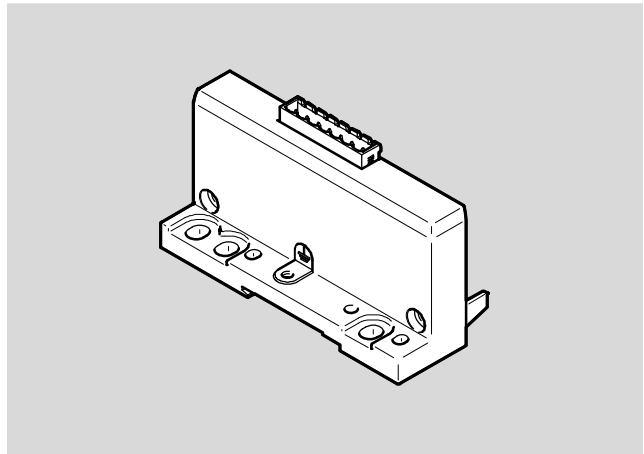

General technical data		
Electrical connection		Plug, 7-pin
Type of mounting		Tie rod
Power supply		System power supply
Maximum power supply	[A]	12
Product weight	[g]	145



Materials	
Housing	Die-cast aluminium, painted
Note on materials	RoHS-compliant

Operating and environmental conditions	
Approval certificate	cULus Recognized (OL)

Pin allocation																	
Circuitry		Pin	Allocation														
Plug, 7-pin																	
<table border="1"> <tr><td>0V</td><td>1</td></tr> <tr><td>24V</td><td>2</td></tr> <tr><td>0V</td><td>3</td></tr> <tr><td>24V</td><td>4</td></tr> <tr><td>0V</td><td>5</td></tr> <tr><td>24V</td><td>6</td></tr> <tr><td>FE</td><td>7</td></tr> </table>	0V	1	24V	2	0V	3	24V	4	0V	5	24V	6	FE	7		1	0 V power supply for valves
0V	1																
24V	2																
0V	3																
24V	4																
0V	5																
24V	6																
FE	7																
		2	24 V DC load voltage supply for valves														
		3	0 V power supply for outputs														
		4	24 V DC load voltage supply for outputs														
		5	0 V power supply for electronics and sensors														
		6	24 V DC power supply for electronics and sensors														
		7	FE														

Terminal CPX

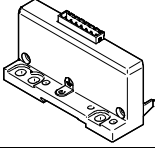
Accessories – End plate with system power supply

Ordering data				
			Part No.	Type
End plate with system power supply				
	End plate for CPX terminal in plastic design		576315	CPX-EPL-EV-S
Terminal strip				
	Plug, 7-pin, straight	Spring-loaded terminal	576319	NECU-L3G7-C1

Terminal CPX

Technical data – End plate with extension

Function

End plates form the outer edge of the CPX terminal.

The earth connection and mounting holes for wall or H-rail mounting are located on the left end plates.

The end plates with extension enable the CPX terminal to be separated into two interconnected terminals. Control is provided via a common bus node or control block.

Application

- Separation of long CPX terminals into two shorter units
- Adaptation for installation in a control cabinet

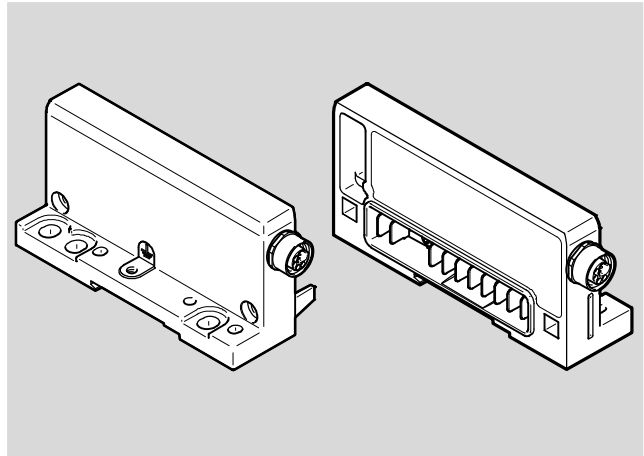

General technical data		
Type	CPX-EP...	CPX-M-EP...
Type of mounting	Tie rod	Angled fitting
Maximum power supply	[A] 6	6

Materials		
Type	CPX-EP...	CPX-M-EP...
Housing	Die-cast aluminium, painted	Die-cast aluminium
Note on materials	RoHS-compliant	RoHS-compliant

Operating and environmental conditions	
Approval certificate	cULus Recognized (OL)

Terminal CPX

Technical data – End plate with extension

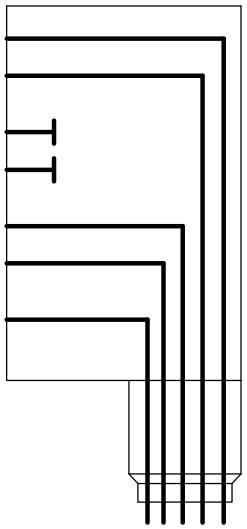
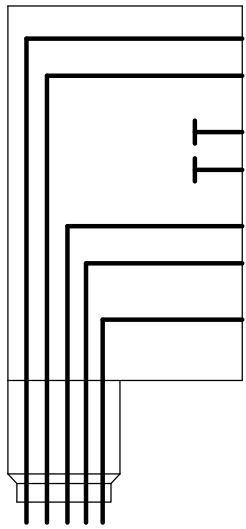
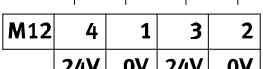
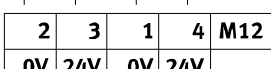
Pin allocation – End plate with extension				
Circuitry	Pin	Allocation	Pin	Circuitry
Right-hand end plate (first row)	Round plug, 8-pin		Left-hand end plate (second row)	
	M12			
0V Valves	1	0 V DC supply voltage for electronics and sensors	1	0V Valves
24V Valves	2	0 V DC load voltage supply for valves	2	24V Valves
0V Output	3	24 V DC load voltage supply for valves	3	0V Output
24V Output	4	24 V DC supply voltage for electronics and sensors	4	24V Output
0V EL./Sen.	5	Bus signal	5	0V EL./Sen.
24V EL./Sen.	6	Bus signal	6	24V EL./Sen.
FE	7	Bus signal	7	FE
	8	Bus signal	8	
	Housing	FE	Housing	
				
				

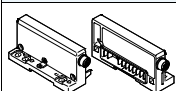
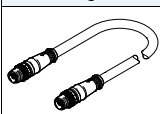
Ordering data		Weight [g]	Part No.	Type
End plate with extension				
	For CPX terminal in plastic design	First row, right-hand end plate	190	576313 CPX-EPR-EV-X
		Second row, left-hand end plate	175	576314 CPX-EPL-EV-X
	For CPX terminal in metal design	First row, right-hand end plate	190	576316 CPX-M-EPR-EV-X
		Second row, left-hand end plate	175	576317 CPX-M-EPL-EV-X
Connecting cable				
	8-pin	0.25 m	47	564189 NEBC-F12G8-KH-0.25-N-S-F12G8
		0.5 m	69	564190 NEBC-F12G8-KH-0.5-N-S-F12G8
		1 m	113	564191 NEBC-F12G8-KH-1-N-S-F12G8
		1.5 m	154	564192 NEBC-F12G8-KH-1.5-N-S-F12G8
		2 m	200	576015 NEBC-F12G8-KH-2-N-S-F12G8
		3 m	280	576636 NEBC-F12G8-KH-3-N-S-F12G8

Terminal CPX

Technical data – Interlinking block with system supply

Function

Interlinking blocks ensure the electrical supply of all other CPX modules. They have contact rails, from which the other CPX components on the interlinking modules are supplied with current.

Internal division of the power supply makes it possible to switch off specific areas of the sensors and actuators individually.

Applications

- 24 V DC supply voltage for electronics of the CPX terminal
- 24 V DC supply voltage for inputs
- 24 V DC supply voltage for valves
- 24 V DC supply voltage for outputs



General technical data		
Nominal operating voltage	[V DC]	24
Protection class to EN 60529		Depending on connection block
Ambient temperature	[°C]	-5 ... +50
Note on materials		RoHS-compliant
Grid dimension	[mm]	50
Dimensions W x L x H	[mm]	50 x 107 x 35

Technical data – Plastic interlinking blocks							
Type		CPX-GE-EV-S					
			-VL	-7/8-4POL	-7/8-5POL	-7/8-5POL-VL	
Electrical connection		M18	M18	7/8", 4-pin	7/8", 5-pin	7/8", 5-pin	
Current supply	Sensors and electronics	[A]	Max. 16	Max. 8	Max. 10	Max. 8	Max. 8
	Valves and outputs	[A]	Max. 16	Max. 8	Max. 10	Max. 8	Max. 8
Materials			PA, reinforced				
Product weight		[g]	125				

Technical data – Metal interlinking blocks							
Type		CPX-M-GE-EV-S					
		-7/8-CIP-4P	-7/8-5POL	-7/8-5POL-VL	-PP-5POL		
Electrical connection		7/8", 4-pin	7/8", 5-pin	7/8", 5-pin	AIDA push-pull, 5-pin		
Current supply	Sensors and electronics	[A]	Max. 10	Max. 8	Max. 8	Max. 16	
	Valves and outputs	[A]	Max. 10	Max. 8	Max. 8	Max. 16	
Materials			Die-cast aluminium				
Product weight		[g]	187	187	187	279	

-  - Note

Note the following points about the interlinking block

CPX-M-GE-EV-S-7/8-CIP-4P:

- Must be mounted as the first module to the right of the left-hand end plate

- Only permitted as an interlinking block to a bus node

- The functional earth (FE) must be connected via the left-hand end plate

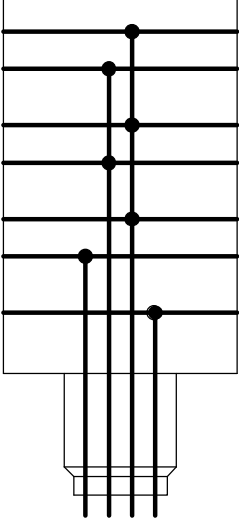
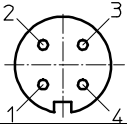
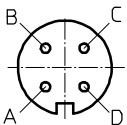
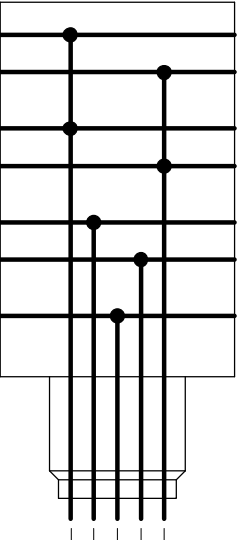
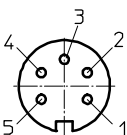

Terminal CPX

Technical data – Interlinking block with system supply

Pin allocation – Plastic interlinking blocks		Pin	Allocation																					
Round connector, 4-pin																								
 <p> 0V Valves 24V Valves 0V Output 24V Output 0V EL./Sen. 24V EL./Sen. FE </p> <table border="1" data-bbox="178 1010 440 1111"> <tr> <td>M18</td> <td>1</td> <td>2</td> <td>3</td> <td>4</td> </tr> <tr> <td>7/8"</td> <td>A</td> <td>B</td> <td>D</td> <td>C</td> </tr> <tr> <td></td> <td>24V</td> <td>24V</td> <td>0V</td> <td>FE</td> </tr> </table>	M18	1	2	3	4	7/8"	A	B	D	C		24V	24V	0V	FE	<p>M18</p>  <table border="1" data-bbox="943 461 1412 593"> <tr> <td>1</td> <td>24 V DC supply voltage for electronics and sensors</td> </tr> <tr> <td>2</td> <td>24 V DC load voltage supply for valves and outputs</td> </tr> <tr> <td>3</td> <td>0 V</td> </tr> <tr> <td>4</td> <td>FE</td> </tr> </table>	1	24 V DC supply voltage for electronics and sensors	2	24 V DC load voltage supply for valves and outputs	3	0 V	4	FE
	M18	1	2	3	4																			
7/8"	A	B	D	C																				
	24V	24V	0V	FE																				
1	24 V DC supply voltage for electronics and sensors																							
2	24 V DC load voltage supply for valves and outputs																							
3	0 V																							
4	FE																							
	<p>7/8"</p>  <table border="1" data-bbox="943 651 1412 784"> <tr> <td>A</td> <td>24 V DC supply voltage for electronics and sensors</td> </tr> <tr> <td>B</td> <td>24 V DC load voltage supply for valves and outputs</td> </tr> <tr> <td>C</td> <td>FE</td> </tr> <tr> <td>D</td> <td>0V</td> </tr> </table>	A	24 V DC supply voltage for electronics and sensors	B	24 V DC load voltage supply for valves and outputs	C	FE	D	0V															
A	24 V DC supply voltage for electronics and sensors																							
B	24 V DC load voltage supply for valves and outputs																							
C	FE																							
D	0V																							
Round connector, 5-pin																								
 <p> 0V Valves 24V Valves 0V Output 24V Output 0V EL./Sen. 24V EL./Sen. FE </p> <table border="1" data-bbox="167 1787 478 1859"> <tr> <td>7/8"</td> <td>1</td> <td>2</td> <td>3</td> <td>4</td> <td>5</td> </tr> <tr> <td></td> <td>0V</td> <td>0V</td> <td>FE</td> <td>24V</td> <td>24V</td> </tr> </table>	7/8"	1	2	3	4	5		0V	0V	FE	24V	24V	<p>7/8"</p>  <table border="1" data-bbox="943 1243 1412 1388"> <tr> <td>1</td> <td>0 V valves and outputs</td> </tr> <tr> <td>2</td> <td>0 V electronics and sensors</td> </tr> <tr> <td>3</td> <td>FE</td> </tr> <tr> <td>4</td> <td>24 V DC supply voltage for electronics and sensors</td> </tr> <tr> <td>5</td> <td>24 V DC load voltage supply for valves and outputs</td> </tr> </table>	1	0 V valves and outputs	2	0 V electronics and sensors	3	FE	4	24 V DC supply voltage for electronics and sensors	5	24 V DC load voltage supply for valves and outputs	
	7/8"	1	2	3	4	5																		
	0V	0V	FE	24V	24V																			
1	0 V valves and outputs																							
2	0 V electronics and sensors																							
3	FE																							
4	24 V DC supply voltage for electronics and sensors																							
5	24 V DC load voltage supply for valves and outputs																							

Terminal CPX

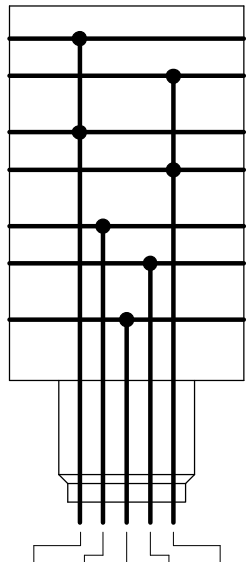
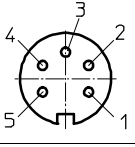
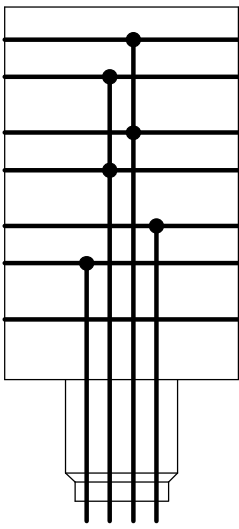
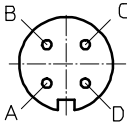
Technical data – Interlinking block with system supply

Pin allocation – Metal interlinking blocks		Pin	Allocation												
Circuitry															
Round connector, 5-pin															
	<p>0V Valves</p> <p>24V Valves</p> <p>0V Output</p> <p>24V Output</p> <p>0V El./Sen.</p> <p>24V El./Sen.</p> <p>FE</p>	7/8"													
			<table border="1"> <tr> <td>1</td> <td>0 V valves and outputs</td> </tr> <tr> <td>2</td> <td>0 V electronics and sensors</td> </tr> <tr> <td>3</td> <td>FE</td> </tr> <tr> <td>4</td> <td>24 V DC supply voltage for electronics and sensors</td> </tr> <tr> <td>5</td> <td>24 V DC load voltage supply for valves and outputs</td> </tr> </table>	1	0 V valves and outputs	2	0 V electronics and sensors	3	FE	4	24 V DC supply voltage for electronics and sensors	5	24 V DC load voltage supply for valves and outputs		
1	0 V valves and outputs														
2	0 V electronics and sensors														
3	FE														
4	24 V DC supply voltage for electronics and sensors														
5	24 V DC load voltage supply for valves and outputs														
<table border="1"> <tr> <td>7/8"</td> <td>1</td> <td>2</td> <td>3</td> <td>4</td> <td>5</td> </tr> <tr> <td></td> <td>0V</td> <td>0V</td> <td>FE</td> <td>24V</td> <td>24V</td> </tr> </table>	7/8"	1	2	3	4	5		0V	0V	FE	24V	24V			
7/8"	1	2	3	4	5										
	0V	0V	FE	24V	24V										
Round connector, 4-pin															
	<p>0V Valves</p> <p>24V Valves</p> <p>0V Output</p> <p>24V Output</p> <p>0V El./Sen.</p> <p>24V El./Sen.</p> <p>FE</p>	7/8"													
			<table border="1"> <tr> <td>A</td> <td>24 V DC supply voltage for electronics and sensors</td> </tr> <tr> <td>B</td> <td>24 V DC load voltage supply for valves and outputs</td> </tr> <tr> <td>C</td> <td>0 V DC supply voltage for electronics and sensors</td> </tr> <tr> <td>D</td> <td>0 V DC load voltage supply for valves and outputs</td> </tr> </table> <p>-  - Note</p> <p>The functional earth (FE) must be connected via the left-hand end plate</p>	A	24 V DC supply voltage for electronics and sensors	B	24 V DC load voltage supply for valves and outputs	C	0 V DC supply voltage for electronics and sensors	D	0 V DC load voltage supply for valves and outputs				
A	24 V DC supply voltage for electronics and sensors														
B	24 V DC load voltage supply for valves and outputs														
C	0 V DC supply voltage for electronics and sensors														
D	0 V DC load voltage supply for valves and outputs														
<table border="1"> <tr> <td>7/8"</td> <td>A</td> <td>B</td> <td>D</td> <td>C</td> </tr> <tr> <td></td> <td>24V</td> <td>24V</td> <td>0V</td> <td>0V</td> </tr> </table>	7/8"	A	B	D	C		24V	24V	0V	0V					
7/8"	A	B	D	C											
	24V	24V	0V	0V											

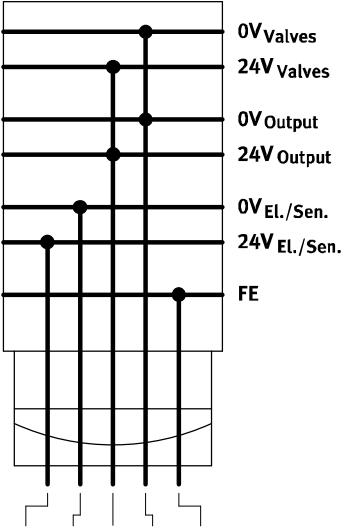
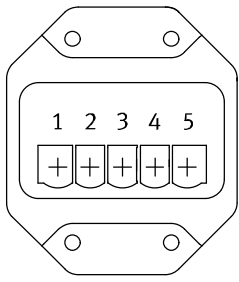

Terminal CPX

Technical data – Interlinking block with system supply

Pin allocation – Metal interlinking blocks		Pin	Allocation																						
Circuitry																									
Push-pull plug, 5-pin																									
 <p>0V Valves 24V Valves 0V Output 24V Output 0V El./Sen. 24V El./Sen. FE</p> <table border="1" data-bbox="172 981 464 1043"> <tr> <td>PP</td> <td>1</td> <td>2</td> <td>3</td> <td>4</td> <td>5</td> </tr> <tr> <td></td> <td>24V</td> <td>0V</td> <td>24V</td> <td>0V</td> <td>FE</td> </tr> </table>		PP	1	2	3	4	5		24V	0V	24V	0V	FE	<p>Plug pattern to PROFINET specification</p>  <table border="1" data-bbox="941 465 1457 779"> <tr> <td>1</td> <td>24 V DC supply voltage for electronics and sensors</td> </tr> <tr> <td>2</td> <td>0 V electronics and sensors</td> </tr> <tr> <td>3</td> <td>24 V DC load voltage supply for valves and outputs</td> </tr> <tr> <td>4</td> <td>0 V valves and outputs</td> </tr> <tr> <td>5</td> <td>FE</td> </tr> </table>		1	24 V DC supply voltage for electronics and sensors	2	0 V electronics and sensors	3	24 V DC load voltage supply for valves and outputs	4	0 V valves and outputs	5	FE
PP	1	2	3	4	5																				
	24V	0V	24V	0V	FE																				
1	24 V DC supply voltage for electronics and sensors																								
2	0 V electronics and sensors																								
3	24 V DC load voltage supply for valves and outputs																								
4	0 V valves and outputs																								
5	FE																								

Terminal CPX

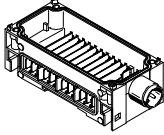
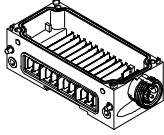
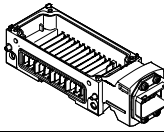
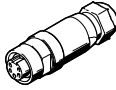
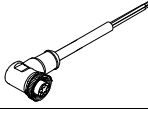
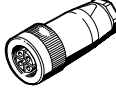
Accessories – Interlinking block with system supply

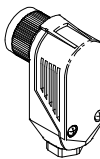
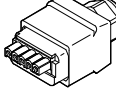
Ordering data					
Designation				Part No.	Type
Interlinking block with system supply					
	Connection M18, plastic interlinking block	4-pin	–	195746	CPX-GE-EV-S
			For ATEX environment	8022170	CPX-GE-EV-S-VL
	Connection 7/8", plastic interlinking block	4-pin	–	541248	CPX-GE-EV-S-7/8-4POL
		5-pin	–	541244	CPX-GE-EV-S-7/8-5POL
	Connection 7/8", metal interlinking block	4-pin	–	568956	CPX-M-GE-EV-S-7/8-CIP-4P
		5-pin	–	550208	CPX-M-GE-EV-S-7/8-5POL
			For ATEX environment	8022165	CPX-M-GE-EV-S-7/8-5POL-VL
	Connection push-pull plug (AIDA), metal interlinking block	5-pin	–	563057	CPX-M-GE-EV-S-PP-5POL
7/8" connection sockets					
	Power supply socket	5-pin	–	543107	NECU-G78G5-C2
			4-pin	–	543108
	Angled socket, 5-pin – Open cable end, 5-wire	2 m	–	573855	NEBU-G78W5-K-2-N-LE5
M18 connection sockets					
	Straight socket, screw terminal	4-pin	PG9	18493	NTSD-GD-9
			PG13.5	18526	NTSD-GD-13,5
	Angled socket, screw terminal	4-pin	PG9	18527	NTSD-WD-9
	Angled socket, screw terminal	4-pin	PG11	533119	NTSD-WD-11
Power supply socket push-pull					
	Socket, spring-loaded terminal, connection pattern PP, fulfils requirements according to AIDA	5-pin	–	5195383	NECU-M-PPG5PP-C1-PN

Terminal CPX

Accessories – Interlinking block with system supply

Ordering data				
Designation			Part No.	Type
Mounting accessories				
	Screws for mounting the bus node/connection block on a plastic interlinking block	Bus node/metal connection block	550218	CPX-DPT-30X32-S-4X
	Screws for mounting the bus node/connection block on a metal interlinking block	Bus node/plastic connection block	550219	CPX-M-M3x22-4x
		Bus node/metal connection block	550216	CPX-M-M3x22-S-4x

Terminal CPX

Technical data – Interlinking block

Function

Interlinking blocks ensure the electrical supply of all other CPX modules. They have contact rails, from which the other CPX components on the interlinking modules are supplied with current.

Internal division of the power supply makes it possible to switch off specific areas of the sensors and actuators individually.

Applications

- All voltages are fed through to the next module by means of an interlinking system.
- The connected electronics module for inputs/outputs or bus node taps off the required voltage.





General technical data		
Type	CPX-GE-EV	CPX-M-GE-EV
Electrical connection	–	–
Nominal operating voltage	[V DC] 24	24
Acceptable current load (per contact/contact rail)	[A] 16	8
Protection class to EN 60529	Depending on connection block	
Ambient temperature	[°C] –5 ... +50	
Note on materials	RoHS-compliant	
Materials	Reinforced PA	Aluminium
Grid dimension	[mm] 50	
Dimensions W x L x H	[mm] 50 x 107 x 35	
Weight	[g] 108	169

Pin allocation			
Circuitry		Pin	Allocation
		–	–
		–	–
		–	–
		–	–

Terminal CPX

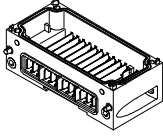
Accessories – Interlinking block

Ordering data					
Designation			Part No.	Type	
Interlinking block without supply					
	Plastic interlinking block		195742	CPX-GE-EV	
	Metal interlinking block		550206	CPX-M-GE-EV	
Mounting accessories					
	Screws for mounting the bus node/connection block on a plastic interlinking block		550218	CPX-DPT-30X32-S-4X	
	Screws for mounting the bus node/connection block on a metal interlinking block		Bus node/metal connection block	550219	CPX-M-M3x22-4x
			Bus node/plastic connection block	550216	CPX-M-M3x22-S-4x

Terminal CPX

Technical data – Interlinking block with additional power supply for outputs

Function

Interlinking blocks ensure the electrical supply of all other CPX modules. They have contact rails, from which the other CPX components on the interlinking modules are supplied with current.

Internal division of the power supply makes it possible to switch off specific areas of the sensors and actuators individually.

Applications

- 24 V DC supply voltage for outputs



General technical data		
Nominal operating voltage	[V DC]	24
Protection class to EN 60529		Depending on connection block
Ambient temperature	[°C]	-5 ... +50
Note on materials		RoHS-compliant
Grid dimension	[mm]	50
Dimensions W x L x H	[mm]	50 x 107 x 35

Technical data – Plastic interlinking blocks							
Type	CPX-GE-EV-Z						
		-VL	-7/8-4POL	-7/8-5POL	-7/8-5POL-VL		
Electrical connection	M18	M18	7/8", 4-pin	7/8", 5-pin	7/8", 5-pin		
Current supply	Outputs	[A]	Max. 16	Max. 8	Max. 10	Max. 8	Max. 8
Materials	PA reinforced						
Product weight	[g]	125					

Technical data – Metal interlinking blocks					
Type	CPX-M-GE-EV-Z				
	-7/8-5POL	-7/8-5POL-VL	-PP-5POL		
Electrical connection	7/8", 5-pin	7/8", 5-pin	AIDA push-pull, 5-pin		
Current supply	Outputs	[A]	Max. 8	Max. 8	Max. 16
Materials	Die-cast aluminium				
Product weight	[g]	187	187	279	

Terminal CPX

Technical data – Interlinking block with additional power supply for outputs

Pin allocation – Plastic interlinking blocks		Pin	Allocation															
Round connector, 4-pin																		
	M18	1	n.c.															
		2	24 V DC load voltage supply for outputs															
		3	0 V															
		4	FE															
	7/8"	A	n.c.															
		B	24 V DC load voltage supply for outputs															
		C	FE															
		D	0V															
<table border="1"> <tr> <td>M18</td> <td>1</td> <td>2</td> <td>3</td> <td>4</td> </tr> <tr> <td>7/8"</td> <td>A</td> <td>B</td> <td>D</td> <td>C</td> </tr> <tr> <td></td> <td>n.c.</td> <td>24V</td> <td>0V</td> <td>FE</td> </tr> </table>	M18	1	2	3	4	7/8"	A	B	D	C		n.c.	24V	0V	FE			
M18	1	2	3	4														
7/8"	A	B	D	C														
	n.c.	24V	0V	FE														
Round connector, 5-pin																		
	7/8"	1	0 V outputs															
		2	n.c.															
		3	FE															
		4	n.c.															
		5	24 V DC load voltage supply for outputs															
<table border="1"> <tr> <td>7/8"</td> <td>1</td> <td>2</td> <td>3</td> <td>4</td> <td>5</td> </tr> <tr> <td></td> <td>0V</td> <td>n.c.</td> <td>FE</td> <td>n.c.</td> <td>24V</td> </tr> </table>	7/8"	1	2	3	4	5		0V	n.c.	FE	n.c.	24V						
7/8"	1	2	3	4	5													
	0V	n.c.	FE	n.c.	24V													





Terminal CPX

Technical data – Interlinking block with additional power supply for outputs

Pin allocation – Metal interlinking blocks																
Circuitry		Pin	Allocation													
Round connector, 5-pin																
		1	0 V outputs													
		2	n.c.													
		3	FE													
		4	n.c.													
		5	24 V DC load voltage supply for outputs													
<table border="1"> <tr> <td>7/8"</td> <td>1</td> <td>2</td> <td>3</td> <td>4</td> <td>5</td> </tr> <tr> <td></td> <td>0V</td> <td>n.c.</td> <td>FE</td> <td>n.c.</td> <td>24V</td> </tr> </table>	7/8"	1	2	3	4	5		0V	n.c.	FE	n.c.	24V				
7/8"	1	2	3	4	5											
	0V	n.c.	FE	n.c.	24V											
Push-pull plug, 5-pin																
		1	n.c.													
		2	n.c.													
		3	24 V DC load voltage supply for outputs													
		4	0 V outputs													
		5	FE													
<table border="1"> <tr> <td>PP</td> <td>1</td> <td>2</td> <td>3</td> <td>4</td> <td>5</td> </tr> <tr> <td></td> <td>n.c.</td> <td>n.c.</td> <td>24V</td> <td>0V</td> <td>FE</td> </tr> </table>	PP	1	2	3	4	5		n.c.	n.c.	24V	0V	FE				
PP	1	2	3	4	5											
	n.c.	n.c.	24V	0V	FE											

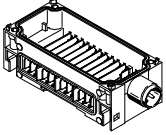
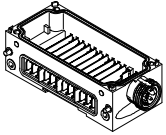
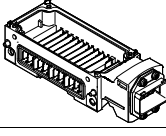
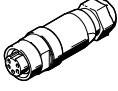
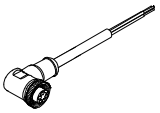
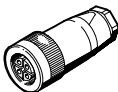
Terminal CPX

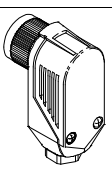
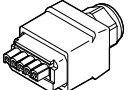
Accessories – Interlinking block with additional power supply for outputs

Ordering data					
Designation				Part No.	Type
Interlinking block with additional power supply for outputs					
	Connection M18, plastic interlinking block	4-pin	–	195744	CPX-GE-EV-Z
			For ATEX environment	8022166	CPX-GE-EV-Z-VL
	Connection 7/8", plastic interlinking block	4-pin	–	541250	CPX-GE-EV-Z-7/8-4POL
		5-pin	–	541246	CPX-GE-EV-Z-7/8-5POL
	Connection 7/8", metal interlinking block	5-pin	–	550210	CPX-M-GE-EV-Z-7/8-5POL
			For ATEX environment	8022158	CPX-M-GE-EV-Z-7/8-5POL-VL
	Connection push-pull plug (AIDA), metal interlinking block	5-pin	–	563058	CPX-M-GE-EV-Z-PP-5POL
7/8" connection sockets					
	Power supply socket	5-pin		543107	NECU-G78G5-C2
		4-pin		543108	NECU-G78G4-C2
	Angled socket, 5-pin – Open cable end, 5-wire	2 m		573855	NEBU-G78W5-K-2-N-LE5
M18 connection sockets					
	Straight socket, screw terminal	4-pin	PG9	18493	NTSD-GD-9
			PG13.5	18526	NTSD-GD-13,5
	Angled socket, screw terminal	4-pin	PG9	18527	NTSD-WD-9
	Angled socket, screw terminal	4-pin	PG11	533119	NTSD-WD-11
Power supply socket push-pull					
	Socket, spring-loaded terminal, connection pattern PP, fulfils requirements according to AIDA	5-pin		5195383	NECU-M-PPG5PP-C1-PN
Mounting accessories					
	Screws for mounting the bus node/connection block on a plastic interlinking block	Bus node/metal connection block		550218	CPX-DPT-30X32-S-4X
		Bus node/plastic connection block		550219	CPX-M-M3x22-4x
		Bus node/metal connection block		550216	CPX-M-M3x22-S-4x

Terminal CPX

Technical data – Interlinking block with additional power supply for valves



Function

Interlinking blocks ensure the electrical supply of all other CPX modules. They have contact rails, from which the other CPX components on the interlinking modules are supplied with current. Internal division of the power supply makes it possible to switch off specific areas of the sensors and actuators individually.

Applications

- 24 V DC supply voltage for valves







General technical data				
Type		CPX-GE-EV-V	CPX-GE-EV-V-VL	CPX-GE-EV-V-7/8-4POL
Electrical connection		M18		7/8", 4-pin
Nominal operating voltage	[V DC]	24		
Acceptable current load (per contact/contact rail)	[A]	16	8	10
Protection class to EN 60529		Depending on connection block		
Ambient temperature	[°C]	-5 ... +50		
Note on materials		RoHS-compliant		
Materials		Reinforced PA		
Grid dimension	[mm]	50		
Dimensions W x L x H	[mm]	50 x 107 x 35		
Weight	[g]	125		

Pin allocation – Plastic interlinking blocks																		
Circuitry		Pin	Allocation															
Round connector, 4-pin																		
	M18		<table border="1"> <tr><td>1</td><td>n.c.</td></tr> <tr><td>2</td><td>24 V DC load voltage supply for valves</td></tr> <tr><td>3</td><td>0 V</td></tr> <tr><td>4</td><td>FE</td></tr> </table>	1	n.c.	2	24 V DC load voltage supply for valves	3	0 V	4	FE							
	1	n.c.																
2	24 V DC load voltage supply for valves																	
3	0 V																	
4	FE																	
7/8"		<table border="1"> <tr><td>A</td><td>n.c.</td></tr> <tr><td>B</td><td>24 V DC load voltage supply for valves</td></tr> <tr><td>C</td><td>FE</td></tr> <tr><td>D</td><td>0V</td></tr> </table>	A	n.c.	B	24 V DC load voltage supply for valves	C	FE	D	0V								
A	n.c.																	
B	24 V DC load voltage supply for valves																	
C	FE																	
D	0V																	
<table border="1"> <tr> <td>M18</td> <td>1</td> <td>2</td> <td>3</td> <td>4</td> </tr> <tr> <td>7/8"</td> <td>A</td> <td>B</td> <td>D</td> <td>C</td> </tr> <tr> <td></td> <td>n.c.</td> <td>24V</td> <td>0V</td> <td>FE</td> </tr> </table>	M18	1	2	3	4	7/8"	A	B	D	C		n.c.	24V	0V	FE			
M18	1	2	3	4														
7/8"	A	B	D	C														
	n.c.	24V	0V	FE														

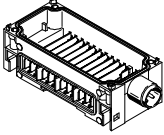
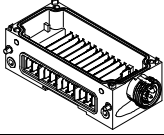
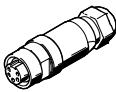
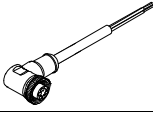
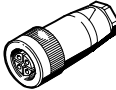
Terminal CPX

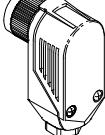
Accessories – Interlinking block with additional power supply for valves

Ordering data					
Designation				Part No.	Type
Interlinking block with additional power supply for valves					
	Connection M18, plastic interlinking block	4-pin	–	533577	CPX-GE-EV-V
			For ATEX environment	8022171	CPX-GE-EV-V-VL
	Connection 7/8", plastic interlinking block	4-pin	–	541252	CPX-GE-EV-V-7/8-4POL
7/8" connection sockets					
	Power supply socket	5-pin		543107	NECU-G78G5-C2
		4-pin		543108	NECU-G78G4-C2
	Angled socket, 5-pin – Open cable end, 5-wire	2 m		573855	NEBU-G78W5-K-2-N-LE5
M18 connection sockets					
	Straight socket, screw terminal	4-pin	PG9	18493	NTSD-GD-9
		4-pin	PG13.5	18526	NTSD-GD-13,5
	Angled socket, screw terminal	4-pin	PG9	18527	NTSD-WD-9
	Angled socket, screw terminal	4-pin	PG11	533119	NTSD-WD-11
Mounting accessories					
	Screws for mounting the bus node/connection block on a plastic interlinking block	Bus node/metal connection block		550218	CPX-DPT-30X32-S-4X

Terminal CPX

Technical data – Pneumatic interface VMPA-FB

Function

The pneumatic interface VMPA-FB establishes the electromechanical connection between the CPX terminal and the valve terminal MPA-S. The signals from the bus node are forwarded to the control electronics in the electrical modules of the valve terminal MPA-S via the integrated CPX bus. The bus signal for activation of the solenoid coils is converted in the electronics module for max. 8 coils. From a technical point of view, the individual MPA pneumatic modules each represent a separate electrical module with digital outputs. Valves, which are galvanically isolated, can be supplied with power via the interlinking block CPX-GE-EV-V.

Applications

- Interface to the valve terminal MPA-S
- Max. 128 solenoid coils
- Features of the electronics module of the valve terminal MPA-S can be parameterised, for example status of the solenoid coils in the event of fieldbus communication being interrupted (fail-safe), individual channel diagnostics can be activated, condition monitoring can be activated individually for each valve
- The pneumatic interface receives the voltage for the electronics and the supply voltage for the valves from the left-hand interlinking block and feeds them through to the electronics modules of the valve terminal MPA-S
- Electronics modules of the valve terminal MPA-S:
 - Undervoltage of valves
 - Short circuit of valves
 - Open load of valves
 - Counter preset reached in condition monitoring



General technical data		
Type	VMPA-FB-EPL-G	VMPA-FB-EPL-E
No. of solenoid coils	128	
Pilot air supply	Internal	External
Pilot air connection 12/14	–	M7
Pneumatic connection 1	G1/4	G1/4
Operating pressure [bar]	3 ... 8	–0.9 ... 10
Pilot pressure [bar]	3 ... 8	3 ... 8
Nominal operating voltage [V DC]	24	
Protection class to EN 60529	IP65	
Ambient temperature [°C]	–5 ... +50	
Materials	Cover	PA
	Housing	Die-cast aluminium
Weight [g]	Approx. 320	

Terminal CPX

Accessories – Pneumatic interface VMPA-FB

Overview – Pneumatic interface VMPA-FB

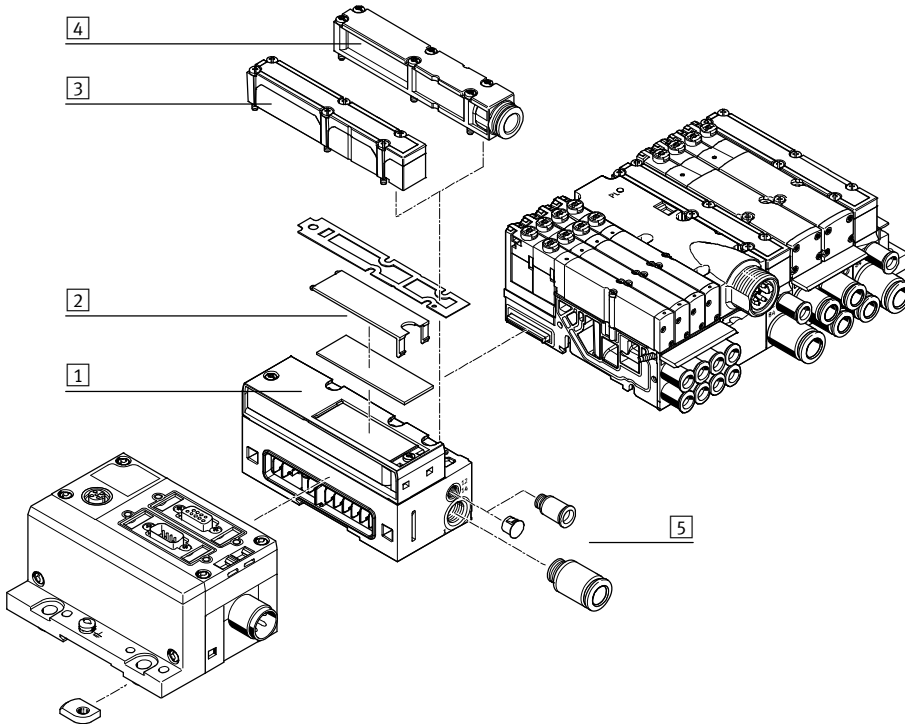

- 1 Pneumatic interface VMPA-FB
- 2 Inscription label
- 3 Flat plate silencer
- 4 Exhaust plate for ducted exhaust air
- 5 Fittings

Ordering data

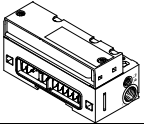
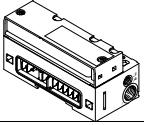
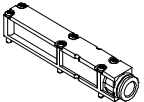
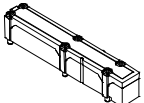
Designation	Part No.	Type
Pneumatic interface for CPX plastic interlinking module		
	Ducted exhaust air, internal pilot air	533370 VMPA-FB-EPL-G
	Ducted exhaust air, external pilot air	533369 VMPA-FB-EPL-E
	Flat plate silencer, internal pilot air	533372 VMPA-FB-EPL-GU
	Flat plate silencer, external pilot air	533371 VMPA-FB-EPL-EU
Pneumatic interface for CPX metal interlinking module		
	Ducted exhaust air, internal pilot air	552286 VMPA-FB-EPLM-G
	Ducted exhaust air, external pilot air	552285 VMPA-FB-EPLM-E
	Flat plate silencer, internal pilot air	552288 VMPA-FB-EPLM-GU
	Flat plate silencer, external pilot air	552287 VMPA-FB-EPLM-EU
Exhaust plate		
	For ducted exhaust air, with 10 mm push-in connector	533375 VMPA-AP
	For ducted exhaust air, with QS-3/8 connector	541629 VMPA-AP-3/8
	Flat plate silencer	533374 VMPA-APU

Terminal CPX

Technical data – Pneumatic interface VMPAL

Function

The pneumatic interface VMPAL establishes the electromechanical connection between the terminal CPX and the valve terminal MPA-L.

The bus signal for actuating the solenoid coils is converted in the pneumatic interface for the entire valve terminal.

The interlinking within the valve terminal is identical with the interlinking with multi-pin plug connections.

Application

- Actuation of the valve terminal MPA-L
- Max. 32 solenoid coils
- The pneumatic interface receives the voltage for the electronics and the supply voltage for the valves from the left-hand interlinking block and feeds them through to the electric modules of the valve terminal MPA-L



General technical data	
Type	VMPAL-EPL-CPX
Number of solenoid coils	32
Operating pressure [bar]	-0.9 ... 10
Pilot pressure [bar]	3 ... 8
Nominal operating voltage [V DC]	24
Protection class to EN 60529	IP67
Ambient temperature [°C]	-5 ... +50
Note on materials	RoHS-compliant

Overview – Pneumatic interface VMPAL

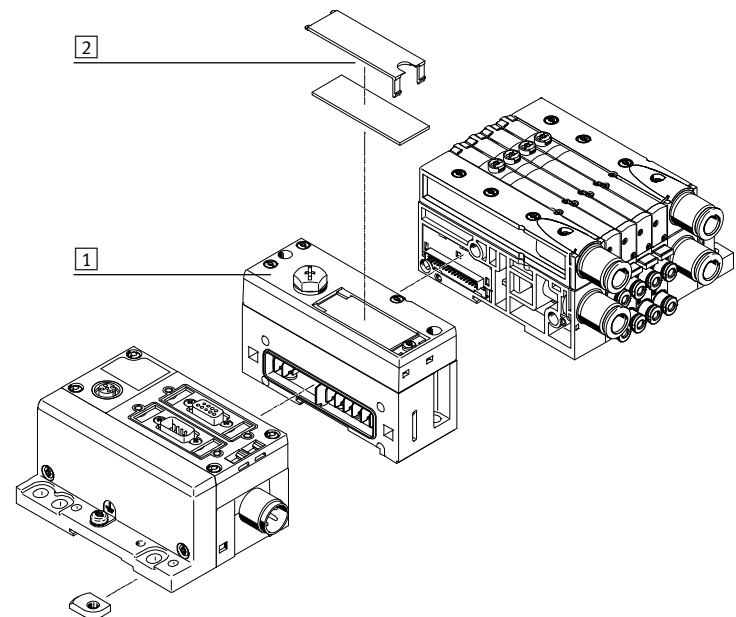

- 1 Pneumatic interface VMPAL
- 2 Inscription label

Ordering data		Part No.	Type
Designation	Pneumatic interface for CPX plastic interlinking module	570783	VMPAL-EPL-CPX

Terminal CPX

Technical data – Pneumatic interface VTSA/VTSA-F

Function

The pneumatic interface VTSA provides the electromechanical connection between the terminal CPX and valve terminal VTSA/VTSA-F.

A complete pneumatic control loop system (FB-valve-drive-sensor-FB) can therefore be connected to the fieldbus using the input modules of the terminal CPX.

Different circuits for valves and electrical outputs are implemented using an additional power supply. The integrated valve diagnostic functions enable the causes of errors to be found quickly, therefore increasing system availability.

Application

- Interface to the valve terminal VTSA and VTSA-F
- Max. 32 solenoid coils
- Address space allocation (configuration) of valve terminals can be set using integrated DIL switches
- Properties of the pneumatic interface can be parameterised, e.g. status of the solenoid coil when fieldbus communication is interrupted (failsafe)
- The pneumatic interface receives the voltage for the electronics and the supply voltage for the valves from the left-hand interlinking block
- Detection of missing solenoid coils and short circuit monitoring for the valves



General technical data			
Number of solenoid coils		32	
Electrical actuation		Fieldbus	
Electrical connection		Via CPX	
Diagnostics		Undervoltage at valves	
Parameterisation		<ul style="list-style-type: none"> • Failsafe per channel • Forces per channel • Idle mode per channel • Module monitoring 	
LED displays		<ul style="list-style-type: none"> • 1 Group diagnostics • Channel status (on each valve) 	
Fuse protection (short circuit)		Internal electronic fuse per valve output	
Electrical isolation channel – internal bus		Yes, when using an additional power supply for the valves	
Nominal operating voltage	[V DC]	24	
Operating voltage range	[V DC]	21.6 ... 26.4	
Intrinsic current consumption at nominal operating voltage	Electronic components	[mA]	Typically 15
	Valves	[mA]	Typically 50
Max. power supply per channel		[A]	0.2
Max. residual current per module		[A]	4
Protection class			<ul style="list-style-type: none"> • IP65 (to EN 60529) • NEMA 4
Ambient temperature		[°C]	-5 ... +50
Materials	Housing		Die-cast aluminium
	Bearing and end cap		PA
Note on materials			RoHS-compliant
Product weight		[g]	590

Ordering data				
Designation		Part No.	Type	
	For plastic interlinking block	543416	VABA-S6-1-X1	
	For metal interlinking block	Diagnostics via fieldbus	550663	VABA-S6-1-X2
		Diagnostics via image table	573613	VABA-S6-1-X2-D

Terminal CPX

Technical data

FESTO

Dimensions – Plastic interlinking module

Download CAD data → www.festo.com

With bus nodes and connection blocks

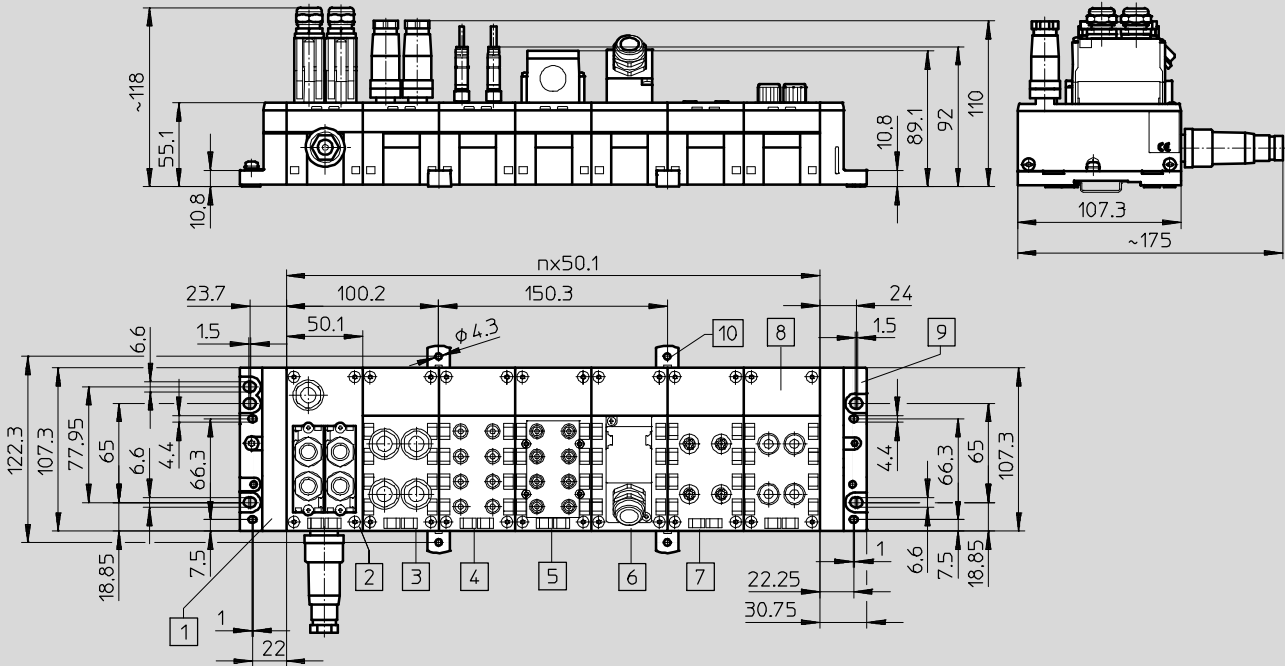

- | | | | | | | | |
|---|--|---|---|----|--|---|--|
| 1 | Left-hand end plate
(earthing plate optional) | 5 | Connection block
CPX-AB-8-KL-4POL | 8 | Connection block
CPX-AB-4-M12x2-5POL | n | Number of bus nodes and
connection blocks for CPX |
| 2 | Bus nodes | 6 | Connection block
CPX-AB-1-SUB-BU-25POL | 9 | Right-hand end plate | | |
| 3 | Connection block
CPX-AB-4-M12-8POL | 7 | Connection block
CPX-AB-4-HAR-4POL | 10 | Mounting clip for wall
mounting (required every
2 ... 3 connection blocks) | | |
| 4 | Connection block
CPX-AB-8-M8-3POL | | | | | | |

Terminal CPX

Technical data

FESTO

Dimensions – Metal interlinking block

Download CAD data → www.festo.com

With bus nodes and connection blocks

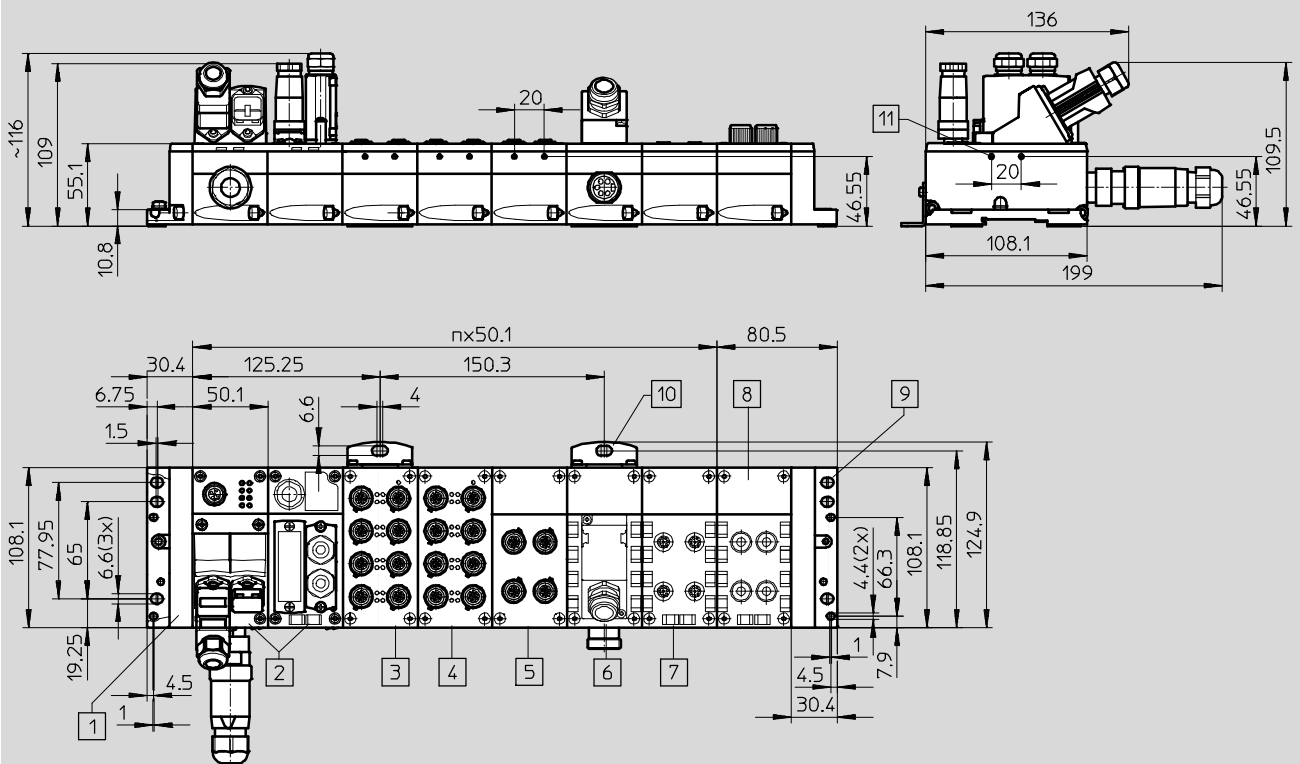

- | | | | | | | | |
|---|---|---|---|----|---------------------------------------|---|--|
| 1 | Left-hand end plate | 6 | Connection block
CPX-AB-1-SUB-BU-25POL | 9 | Right-hand end plate | n | Number of bus nodes and
connection blocks for CPX |
| 2 | Bus nodes | 7 | Connection block CPX-
AB-4-M12-8POL | 10 | Mounting bracket for wall
mounting | | |
| 3 | Connection block
CPX-M-AB-8-M12X2-5POL | 8 | Connection block
CPX-AB-4-HAR-4POL | 11 | Hole for self-tapping screw
M2.5 | | |
| 4 | Connection block
CPX-M-AB-8-M12X2-5POL | | | | | | |
| 5 | Connection block
CPX-M-AB-4-M12X2-5POL | | | | | | |

Terminal CPX

Technical data

FESTO

Dimensions

Download CAD data → www.festo.com

With bus nodes and valve terminal VTSA

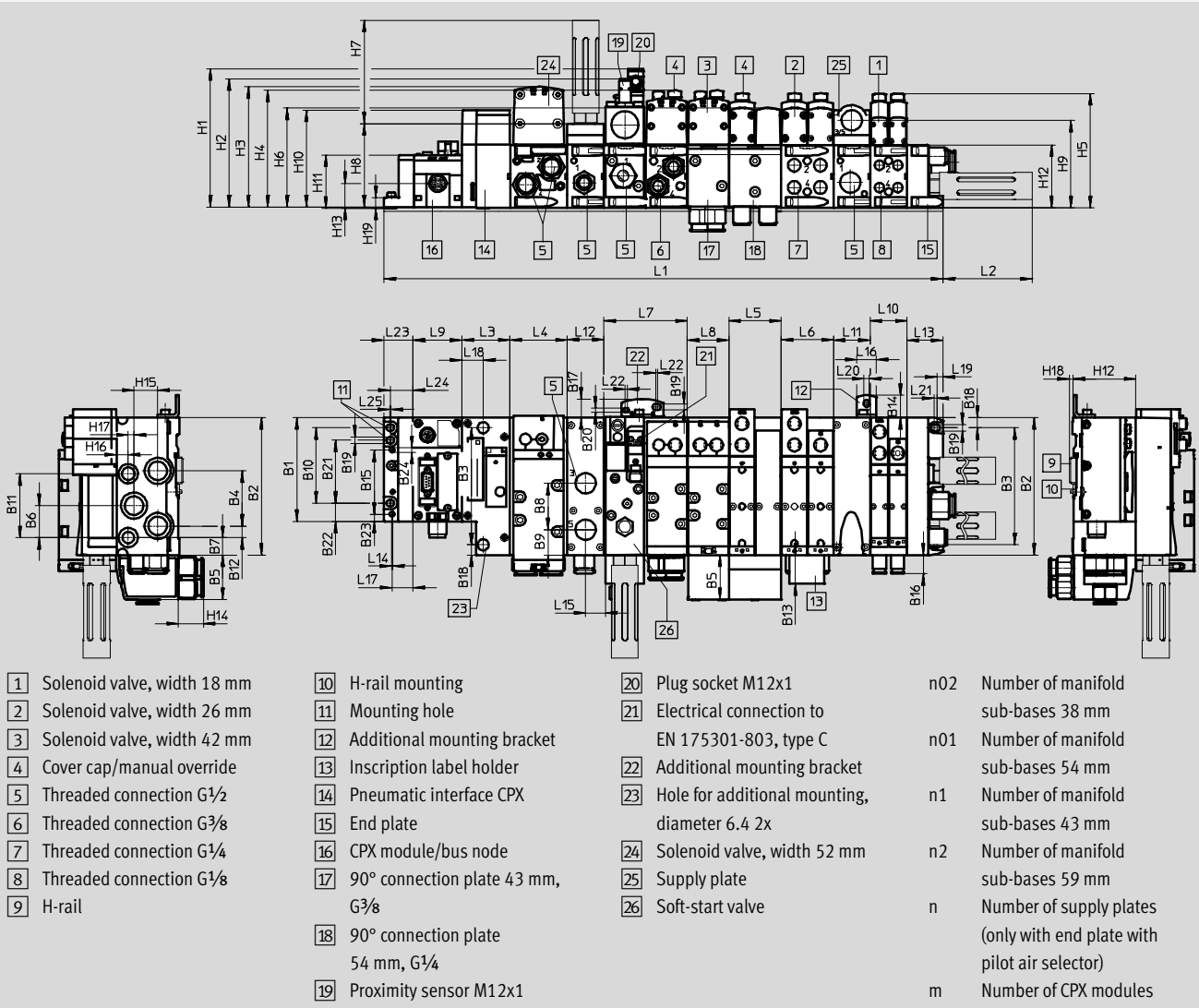

Dim.	B1	B2	B3	B4	B5	B6	B7	B8	B9	B10	B11	B12	B13	B14	B16	B18	B19	B20	B21	B22	B23	B24
[mm]	107.3	142	121	57	46	33	18	48	26	78	66	12	29.6	23	19.5	10.5	6.6	4.5	65	18.9	7.5	4.4

Dim.	L2	L3	L4	L5	L6	L7	L8	L9	L10	L11	L12	L13	L14	L15	L16	L17	L18	L19	L20	L21	L22
[mm]	92.4	50	n2x59	n01x54	54	n1x43	43	mx20.1	n02x38	nx38	38	37.3	1	20.5	20	22	22	6.3	5.5	3	2

Dim.	L23	L24	L25	H1	H2	H3	H4	H5	H6	H7	H8	H9	H10	H11	H12	H13	H14	H15	H16	H17	H18	H19
[mm]	30.4	23.7	1.5	143.9	133.3	125	121.3	118.2	103	106.8	87	90.3	101.4	55.1	65	25.8	25.7	24.5	12	6	3.5	10.8

Width	L1
18 mm	$30.4 + m \times 50.1 + 50 + n02 \times 38 + n \times 38 + 37.3$
26 mm	$30.4 + m \times 50.1 + 50 + n01 \times 54 + n \times 38 + 37.3$
42 mm	$30.4 + m \times 50.1 + 50 + n1 \times 43 + n \times 38 + 37.3$
52 mm	$30.4 + m \times 50.1 + 50 + n2 \times 59 + n \times 38 + 37.3$
Mixture of 18 mm, 26 mm, 42 mm and 52 mm	$30.4 + m \times 50.1 + 50 + n02 \times 38 + n01 \times 54 + n1 \times 43 + n2 \times 59 + n \times 38 + 37.3$

– Note: This product conforms to ISO 1179-1 and to ISO 228-1

Terminal CPX

Technical data

FESTO

Dimensions

Download CAD data → www.festo.com

With bus nodes and valve terminal VTSA-F

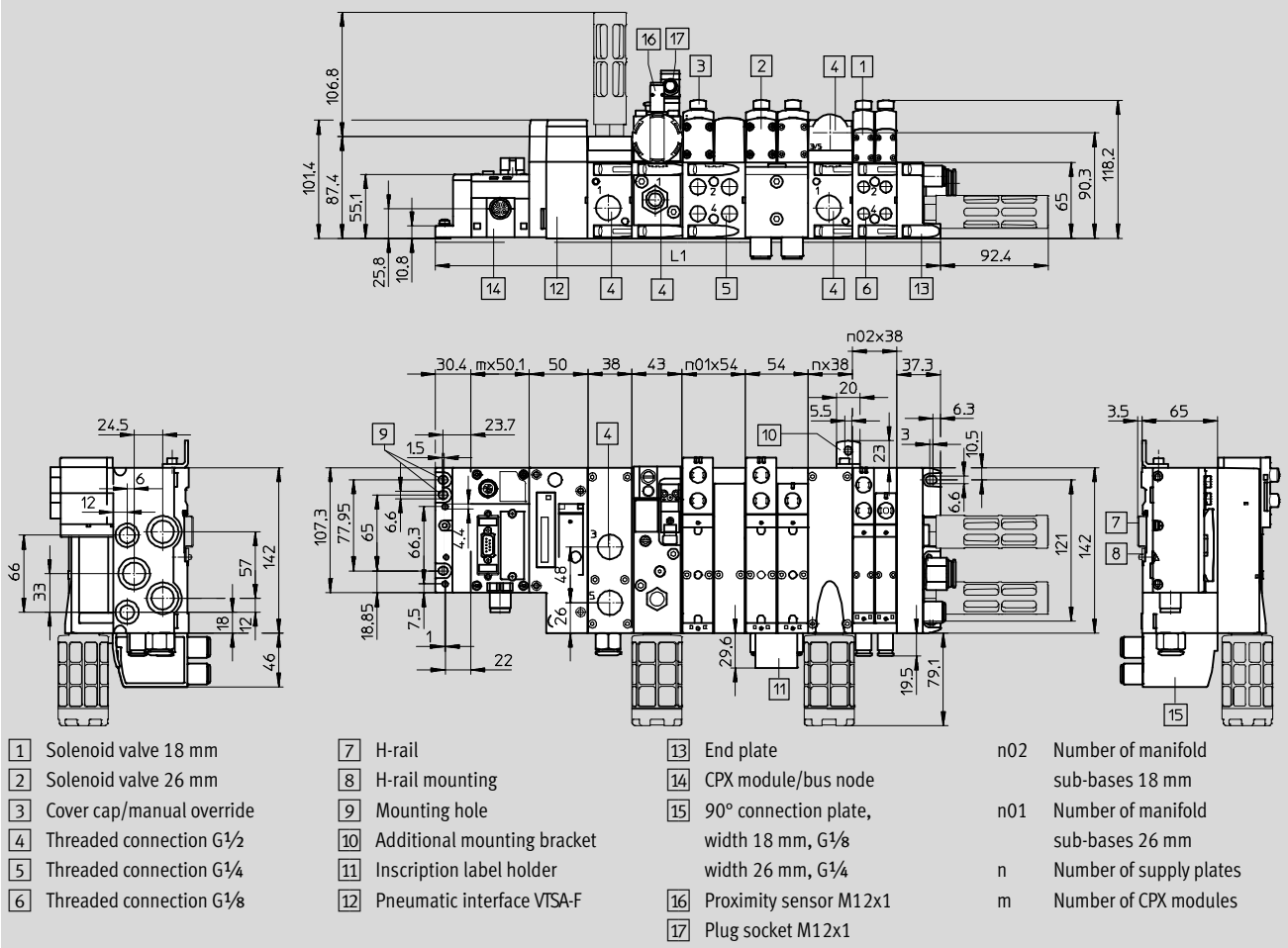

Width	L1
18 mm	$30.4 + m \times 50.1 + 50 + n02 \times 38 + n \times 38 + 37.3$
26 mm	$30.4 + m \times 50.1 + 50 + n01 \times 54 + n \times 38 + 37.3$
Mixture of 18 mm and 26 mm	$30.4 + m \times 50.1 + 50 + n02 \times 38 + n01 \times 54 + n \times 38 + 37.3$

Terminal CPX

Technical data

Dimensions

Download CAD data → www.festo.com

With bus nodes and valve terminal MPA-S

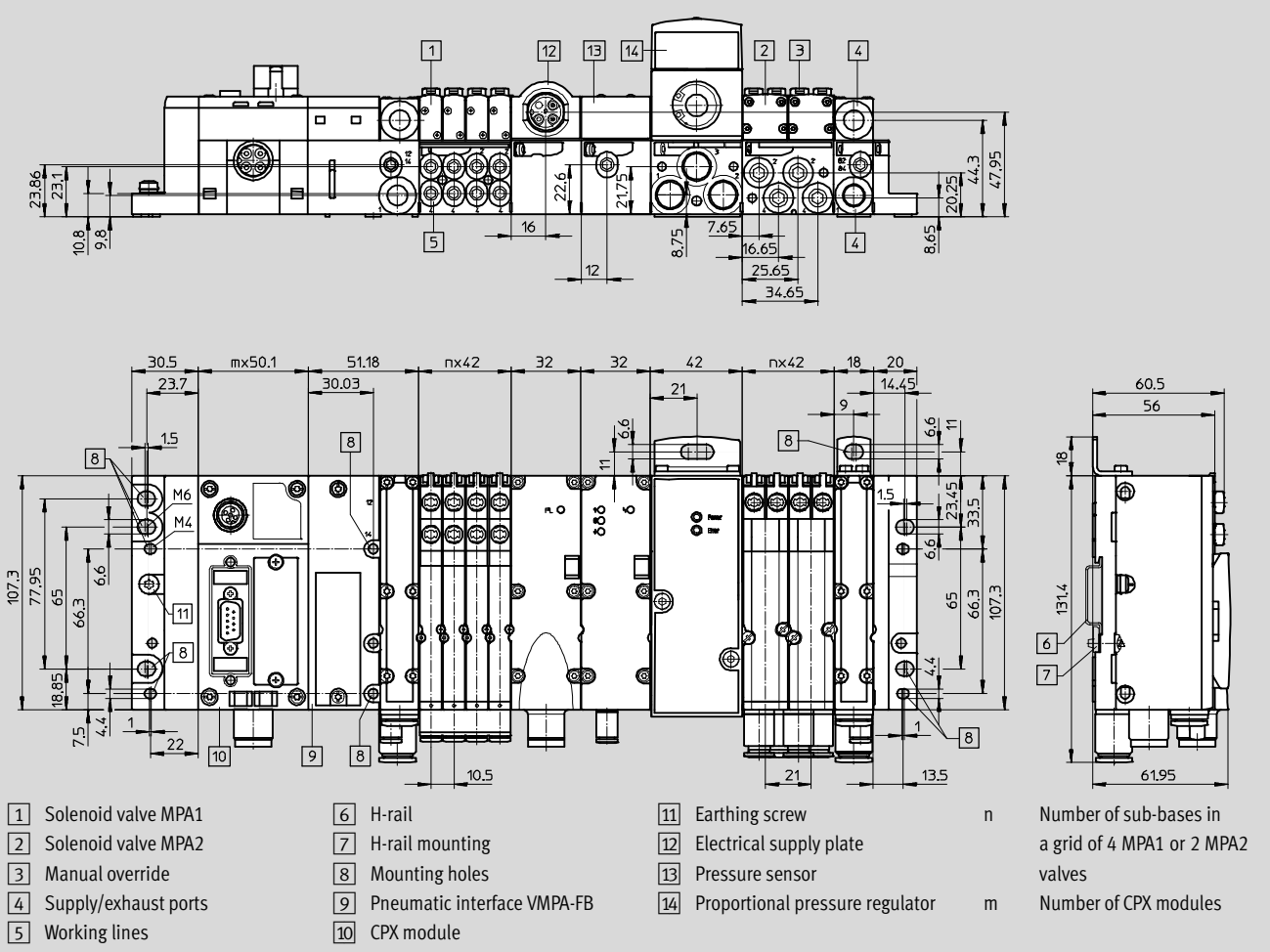

Terminal CPX

Technical data

Dimensions

Download CAD data → www.festo.com

With bus node and valve terminal MPA-L

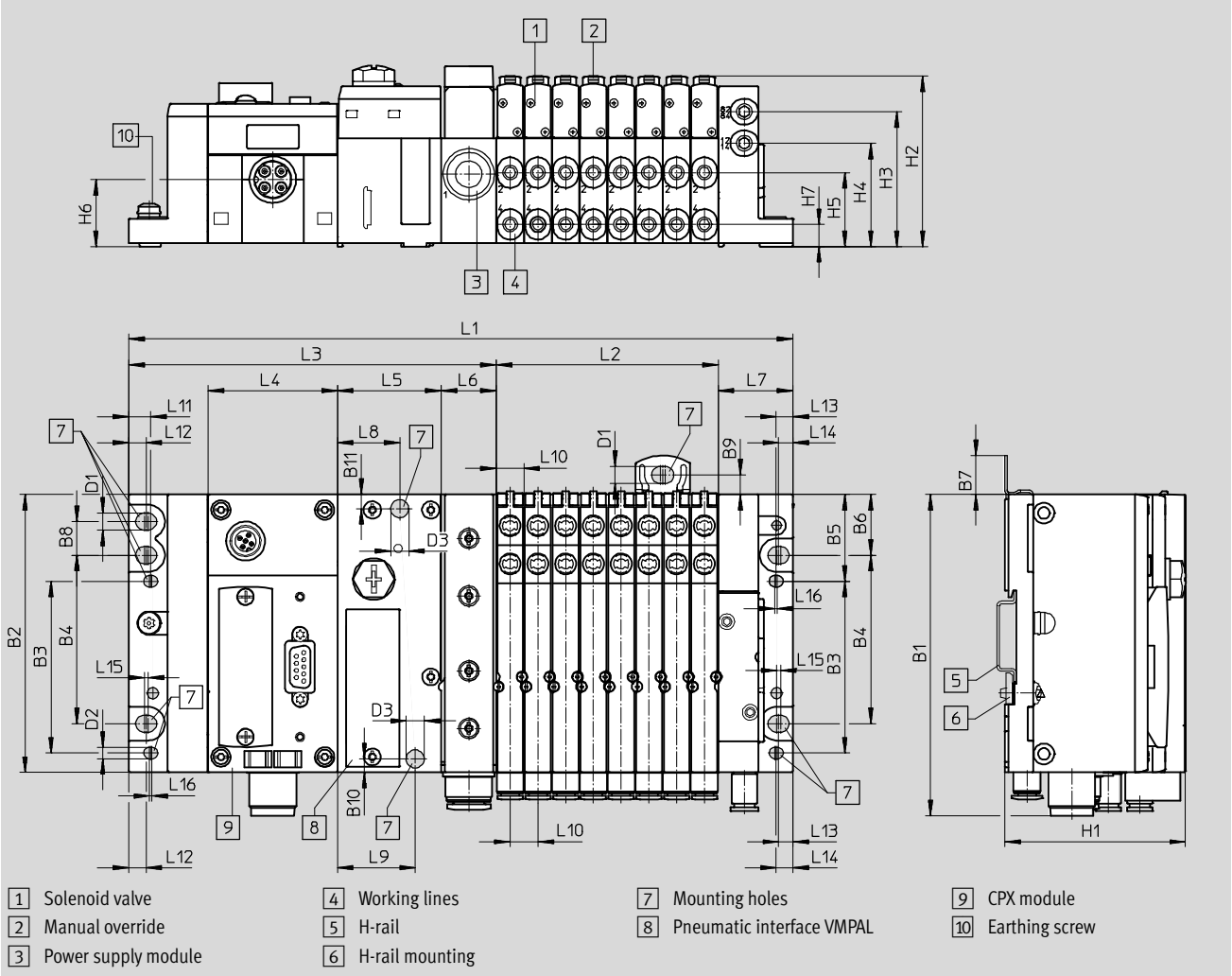

Type	L1 ¹⁾	L2 ¹⁾	L3	L4	L5	L6	L7	L8	L9	L10	L11	L12	L13	L14	D1	D2	D3
MPA-L	170.9 + n x 10.70	n x 10.70	142.1	50	40.1	21.2	28.8	24	30	10.7	8.5	6.8	5.6	6.5	6.6	4.4	7







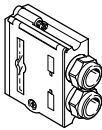

Type	B1	B2	B3	B4	B5	B6	B7	B8	B9	B10	B11	H1	H2	H3	H4	H5	H6	H7
MPA-L	124	107.3	66.3	65	33.5	23.5	15	13	7.5	5.3	5.5	69.6	65.7	52	39.8	28.5	25.8	8.5

1) n = Number of sub-bases/valve positions

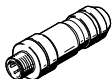
Terminal CPX

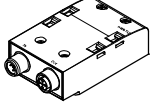
Accessories

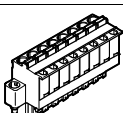
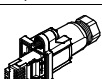
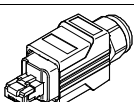
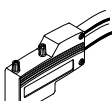
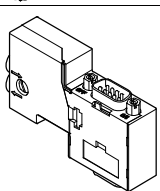

FESTO

Ordering data – Accessories					
Designation			Part No.	Type code	
Connectors and accessories					
	Sub-D plug for INTERBUS		Incoming	532218 FBS-SUB-9-BU-IB-B	
			Outgoing	532217 FBS-SUB-9-GS-IB-B	
	Sub-D plug for DeviceNet/CANopen			532219 FBS-SUB-9-BU-2x5POL-B	
	Sub-D plug for PROFIBUS DP			532216 FBS-SUB-9-GS-DP-B	
	Sub-D plug for CC-Link			532220 FBS-SUB-9-GS-2x4POL-B	
	Sub-D plug			534497 FBS-SUB-9-GS-1x9POL-B	
	Bus connection M12 adapter (B-coded) for PROFIBUS DP			533118 FBA-2-M12-5POL-RK	
	Micro style bus connection, 2xM12 for DeviceNet/CANopen			525632 FBA-2-M12-5POL	
	For micro style connection, M12		Socket	18324 FBSD-GD-9-5POL	
			Plug	175380 FBS-M12-5GS-PG9	
	M12x1 bus connection, 4-pin (D-coded) for Ethernet			543109 NECU-M-S-D12G4-C2-ET	
	For FBA-2-M12-5POL-RK and CPX-AB-2-M12-RK-DP, M12x1, 5-pin, straight		Socket	1067905 NECU-M-B12G5-C2-PB	
			Plug	1066354 NECU-M-S-B12G5-C2-PB	
	Plug M12x1, 4-pin, straight, A-coded	Insulation displacement connect.	Connection cross-section 0.25 ... 0.5 mm ²		525928 SEA-GS-HAR-4POL
			Screw terminal	Connection cross-section 0.14 ... 0.5 mm ²	
Permissible cable diameter 4 ... 6 mm		18666 SEA-GS-7			
Permissible cable diameter 6 ... 8 mm		18778 SEA-GS-9			
	Connection block, 9-pin Sub-D socket, 5-pin 7/8" plug for DeviceNet			571052 CPX-AB-1-7/8-DN	
	Connection block M12 adapter (B-coded)		For PROFIBUS DP	541519 CPX-AB-2-M12-RK-DP	
			For Interbus	534505 CPX-AB-2-M12-RK-IB	
	Open style bus connection for 5-pin terminal strip for DeviceNet/CANopen			525634 FBA-1-SL-5POL	
	Terminal strip for open style connection, 5-pin			525635 FBSD-KL-2x5POL	
	Screw terminal bus connection for CC-Link			197962 FBA-1-KL-5POL	
	8-pin socket		Spring-loaded terminal	565712 NECU-L3G8-C1	
			Screw terminal	565710 NECU-L3G8-C2	
	RJ45/plug			534494 FBS-RJ45-8-GS	
	RJ45 plug, 8-pin, push-pull			552000 FBS-RJ45-PP-GS	
	Plug SCRJ, 2-pin, push-pull, for CPX-M-FB35			571017 FBS-SCRJ-PP-GS	
	Plug for CAN bus interface, electric axes Sub-D, 9-pin, without terminating resistor			533783 FBS-SUB-9-WS-CO-K	
	Sub-D socket with terminating resistor and programming interface		For CANopen	574588 NECU-S1W9-C2-ACO	
	Sub-D plug, straight, with terminating resistor and programming interface		For PROFIBUS	574589 NECU-S1W9-C2-APB	

Terminal CPX

Accessories

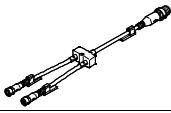
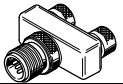
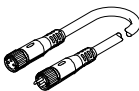
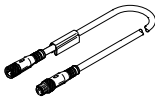
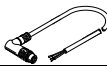

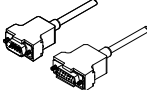
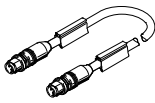
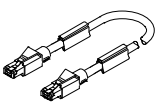

FESTO

Ordering data – Accessories				
Designation			Part No.	Type code
Distributors				
	Modular system for all types of sensor/actuator distributors		–	NEDY-... ➔ Internet: nedy
	Push-in T-connector	1x plug M8, 4-pin	2x socket M8, 3-pin	8005312 NEDY-L2R1-V1-M8G3-N-M8G4
		1x plug M12, 4-pin	2x socket M8, 3-pin	8005311 NEDY-L2R1-V1-M8G3-N-M12G4
			2x socket, M12, 5-pin	8005310 NEDY-L2R1-V1-M12G5-N-M12G4
Connecting cables				
	Modular system for any connecting cable		–	NEBU-... ➔ Internet: nebu
	Connecting cable M8-M8, Straight plug/straight socket	0.5 m	541346	NEBU-M8G3-K-0.5-M8G3
		1.0 m	541347	NEBU-M8G3-K-1-M8G3
		2.5 m	541348	NEBU-M8G3-K-2.5-M8G3
		5.0 m	541349	NEBU-M8G3-K-5-M8G3
	Connecting cable M12-M12, 5-pin, Straight plug/straight socket	1.5 m	529044	KV-M12-M12-1,5
		3.5 m	530901	KV-M12-M12-3,5
	Connecting cable for CPX-CTEL, M12-M12, 5-pin, straight plug/straight socket	5 m	574321	NEBU-M12G5-E-5-Q8N-M12G5
		7.5 m	574322	NEBU-M12G5-E-7.5-Q8N-M12G5
		10 m	574323	NEBU-M12G5-E-10-Q8N-M12G5
	Connecting cable M12-M12, 8-pin, Straight plug/straight socket	2.0 m	525617	KM12-8GD8GS-2-PU
	Connecting cable M9, 5-pin, angled plug/open cable end 3-pin	2 m	563711	NEBC-M9W5-K-2-N-LE3
		5 m	563712	NEBC-M9W5-K-5-N-LE3
	Connecting cable M9, angled plug/angled socket	0.25 m	540327	KVI-CP-3-WS-WD-0,25
		0.5 m	540328	KVI-CP-3-WS-WD-0,5
		2 m	540329	KVI-CP-3-WS-WD-2
		5 m	540330	KVI-CP-3-WS-WD-5
		8 m	540331	KVI-CP-3-WS-WD-8
	Connecting cable M9, straight plug/straight socket	2 m	540332	KVI-CP-3-GS-GD-2
		5 m	540333	KVI-CP-3-GS-GD-5
		8 m	540334	KVI-CP-3-GS-GD-8
	Programming cable, sub-D socket, 9-pin	Sub-D plug, 9-pin	3 m	151915 KDI-PPA-3-BU9
	Connecting cable for RS232 interface, Sub-D socket, 15-pin	Open end, 3-wire	5 m	539642 FEC-KBG7
		Sub-D plug, 9-pin	2.5 m	539643 FEC-KBG8
	Connecting cable, straight plug, M12x1, 4-pin, D-coded	Straight plug, M12x1, 4-pin, D-coded	0.5 m	8040446 NEBC-D12G4-ES-0.5-S-D12G4-ET
			1 m	8040447 NEBC-D12G4-ES-1-S-D12G4-ET
			3 m	8040448 NEBC-D12G4-ES-3-S-D12G4-ET
			5 m	8040449 NEBC-D12G4-ES-5-S-D12G4-ET
			10 m	8040450 NEBC-D12G4-ES-10-S-D12G4-ET
	Straight plug, RJ45, 8-pin	1 m	8040451 NEBC-D12G4-ES-1-S-R3G4-ET	
		3 m	8040452 NEBC-D12G4-ES-3-S-R3G4-ET	
		5 m	8040453 NEBC-D12G4-ES-5-S-R3G4-ET	
		10 m	8040454 NEBC-D12G4-ES-10-S-R3G4-ET	
		Open end, 4-wire	5 m	8040456 NEBC-LE4-ES-5-D12G4-ET
	Connecting cable, straight plug, RJ45, 8-pin	Straight plug, RJ45, 8-pin	1 m	8040455 NEBC-R3G4-ES-1-S-R3G4-ET

Terminal CPX

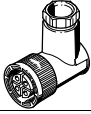
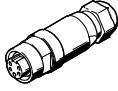
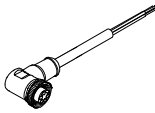
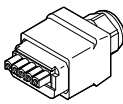
Accessories

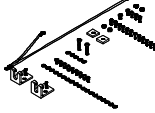
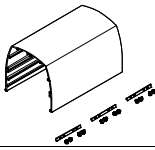





FESTO

Ordering data – Accessories				
Designation			Part No.	Type code
Connectors and accessories – Power supply				
	Plug socket for mains connection M18, straight	For 1.5 mm ²	18493	NTSD-GD-9
		For 2.5 mm ²	18526	NTSD-GD-13,5
	Plug socket for mains connection M18, angled	For 1.5 mm ²	18527	NTSD-WD-9
		For 2.5 mm ²	533119	NTSD-WD-11
	Power supply socket, straight	7/8" connection, 5-pin	543107	NECU-G78G5-C2
		7/8" connection, 4-pin	543108	NECU-G78G4-C2
	7/8" power supply socket, 5-pin, angled socket/open cable end, 5-wire	2 m	573855	NEBU-G78W5-K-2-N-LE5
	Push-pull power supply socket, connection pattern PP, fulfils requirements to AIDA	5-pin	5195383	NECU-M-PPG5PP-C1-PN
	Straight plug, spring-loaded terminal, for left-hand end plate with system supply	7-pin	576319	NECU-L3G7-C1
Hood				
	Mounting rail for attaching the hood	1000 mm	572256	CAFC-X1-S
	Mounting kit for CPX hood		572257	CAFC-X1-BE
	Hood section for CPX terminal including mounting attachments for connecting several hood sections in series	200 mm	572258	CAFC-X1-GAL-200
		300 mm	572259	CAFC-X1-GAL-300
Screws				
	Screws for mounting the bus node/connection block on the polymer interlinking block	Bus node/metal connection block	550218	CPX-DPT-30X32-S-4X
		Bus node/polymer connection block	550219	CPX-M-M3x22-4x
		Bus node/metal connection block	550216	CPX-M-M3x22-S-4x
	Screws for mounting an inscription label on the bus node (CPX-FB33, CPX-M-FB34, CPX-M-FB35)	12 pieces	550222	CPX-M-M2,5X8-12X

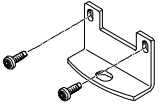
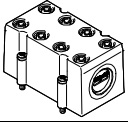
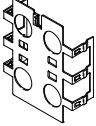
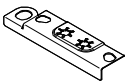
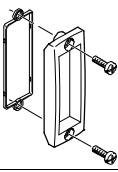
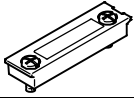
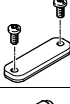
Terminal CPX

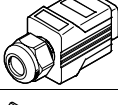
Accessories



FESTO

Ordering data – Accessories				
Designation			Part No.	Type code
Mounting				
	Attachment for wall mounting (for long valve terminals, 10 pieces)	Version for polymer interlinking plates	529040	CPX-BG-RW-10x
	Attachment for wall mounting, version for metal interlinking plates	2 mounting brackets, 4 screws	550217	CPX-M-BG-RW-2X
		1 mounting bracket, 2 screws	2721419	CPX-M-BG-VT-2X
Coverings and attachments				
	Cover for CPX-AB-8-KL-4POL (IP65, IP67) – 8 cable through-feeds M9 – 1 cable through-feed for multi-pin plug		538219	AK-8KL
		Fittings kit	538220	VG-K-M9
	Screening plate for M12 connections		526184	CPX-AB-S-4-M12
	Earthing element (5 pieces), for right-hand/left-hand end plate (polymer interlinking blocks)		538892	CPX-EPFE-EV
	Inspection cover, transparent		533334	AK-SUB-9/15-B
	Transparent cover for DIL switch and memory card		548757	CPX-AK-P
		Cover for DIL switch and memory card	548754	CPX-M-AK-M
	Cover plate for covering the DIL switches on CPX-M-FB21		572818	CPX-M-FB21-IB-RL
	Cover for RJ45 connection		534496	AK-Rj45
	Cover for RJ45 push-pull connection		548753	CPX-M-AK-C
	Cover cap for bus connection		2873540	CPX-M-AK-D
	Cover cap for closing off unused ports (10 pieces)	For M8 connections	177672	ISK-M8
		For M12 connections	165592	ISK-M12
	Coding element, so that a coded socket NECU-L3G8 can only be inserted in the matching coded connection block CPX-P-AB-2XKL (96 pieces of each)	For NECU-L3G8	565713	CPX-P-KDS-AB-2XKL

Terminal CPX

Accessories

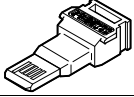
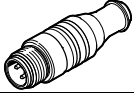
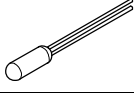
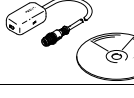
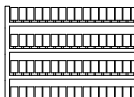
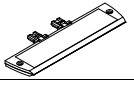
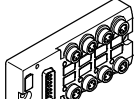
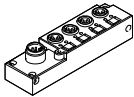
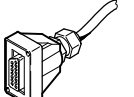
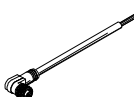
FESTO

Ordering data – Accessories			
Designation		Part No.	Type code
Function elements			
	Memory card for PROFINET bus node (CPX-FB33, CPX-M-FB34, CPX-M-FB35), 2MB	568647	CPX-SK-2
	Terminating resistor, M12, B-coded for PROFIBUS	1072128	CACR-S-B12G5-220-PB
	PT1000 temperature sensor for cold junction compensation	553596	CPX-W-PT1000
	Adapter, 5-pin M12 to mini USB socket, and controller software	547432	NEFC-M12G5-0.3-U1G5
Inscription labels			
	Inscription labels 6x10 mm, 64 pieces, in frames	18576	IBS-6x10
	Inscription label holder for connection block	536593	CPX-ST-1
Multi-pin plug distributors			
	Sub-D plug, 15-pin	8x socket M8, 3-pin	177669 MPV-E/A08-M8
		12x socket M8, 3-pin	177670 MPV-E/A12-M8
	Plug M12, 8 pin	4x socket, M8, 3-pin	574586 NEDU-L4R1-M8G3L-M12G8
		6x socket, M8, 3-pin	574587 NEDU-L6R1-M8G3L-M12G8
Connecting cable for multi-pin plug distributor			
	Sub-D socket, 15-pin, open cable end, 15-wire	5 m	177673 KMPV-SUB-D-15-5
		10 m	177674 KMPV-SUB-D-15-10
	Angled socket, M12, 8-pin, open cable end, 8-wire	Length 2 m	542256 NEBU-M12W8-2-N-LE8
		Length 5 m	542257 NEBU-M12W8-5-N-LE8
		Length 10 m	570007 NEBU-M12W8-10-N-LE8
	Straight socket, M12, 8-pin, open cable end, 8-wire	Length 2 m	525616 SIM-M12-8GD-2-PU
		Length 5 m	525618 SIM-M12-8GD-5-PU
		Length 10 m	570008 SIM-M12-8GD-10-PU
Software			
	Programming software	German	537927 P.SW-FST4-CD-DE
		English	537928 P.SW-FST4-CD-EN