

Compact Programmable Logic Controller with Built-in Display Visual KV Series

Industry First

Visual PLC

**World's
Smallest**



User-Friendly Design

Designed with the user in mind, the Visual KV is a high-speed compact unit. It features the industry's first built-in access window and includes an AC power supply model and operator interface panel.

Ultra Small Size

High Speed Scan Time
of 140 s

Complete Product Line

AC/DC, Transistor (NPN/PNP)/Relay
12 base units/8 expansion units



Built-in Operator Interface PLC &

For
Design
Engineers

No PC or Handheld Programmer Required to Monitor Operation or Make Minor Changes



The Visual KV CPU features a built-in display (Access Window) that allows the PLC's data to be checked upon start-up and during modification or changeover.

Access Window Allows Information to be Conveniently Available

When checking or changing some device values the PLC does not need to be connected to either a PC or handheld programmer.



When making precise on-line adjustments to internal devices, such as a timer, while the PLC is operating.



When you need to stop the PLC and check the program without connecting to a PC or handheld programmer.



Other Functions

Key Lock Function

The Visual KV features a key lock function to prevent accidental changes to the settings.

Error Message Function

Error codes are immediately displayed on the LCD. With a conventional PLC, the PLC had to be connected to a handheld programmer in order to determine the error code.

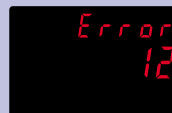

User Message Function

With a simple ladder program, a flashing LED display message (No.0 to 255) can appear, indicating a user error code.

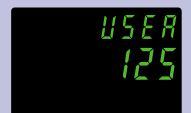

User Friendly Operator Panel

for
Factory
Staff

Ladder Comment Display- Allows you to easily check, change or detect abnormalities.



In addition to having the same functions as the Visual KV PLC's Access Window, the operator panel displays comments generated by a ladder program. This easy to use display features a variety of functions.

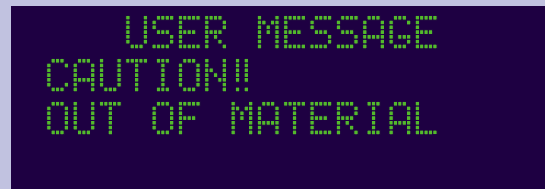

Displays operational instruction messages.

The Operator Panel Provides Features of a Full Scale Display

The on-screen feedback digital trimmer allows workers to make adjustments without stopping the production line.

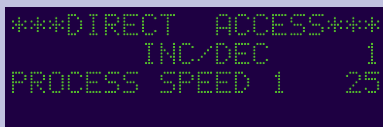

At a glance, the status of registered customized switches F1 to F4 and lamps 1 to 4 can be confirmed.

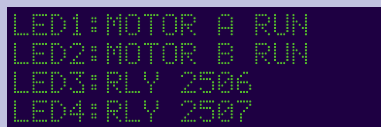

Input and output status of the I/O terminals can be monitored.

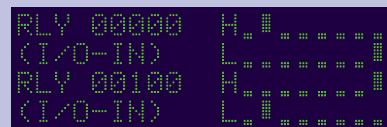

Built-In Operator Convenience Functions

Beep function

The KV-D20 features a beep function to provide audio cues to workers.

Display customization

Workers can choose from various display options to create a customized, easy-to-see display.

A modular cable completes the connection.

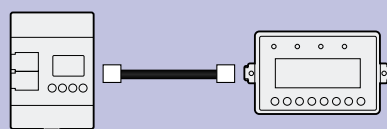

World's Smallest Design*

2/3rd the size of conventional AC type PLCs

The new AC version 40 I/O KV is 2/3rd the size of conventional PLCs. The slender design not only saves mounting space, but allows the entire system including the distribution panel and the control box to be downsized.

(*For AC types that use screw-type terminal blocks)

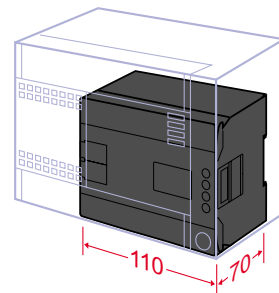

World's Fastest Class

The fastest processing among products of this class.

The minimum scan time is 140 μs and the minimum instruction execution time is 0.7 μs.

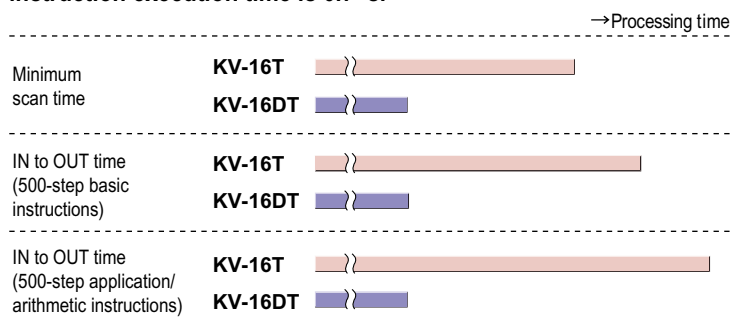

The processing time is **decreased by 50%** compared to that of our conventional product.

Industry First Design Patent pending

The PLC has a 2-colour backlit LCD(5 digits x 3), that is used for display functions.

Typical Applications



Displays the current and preset values of the counter or timer.



Serves as a handheld programmer when changing the preset value.

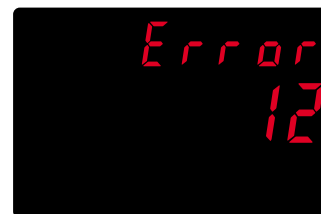

Displays the error code.

Practical Functions

2-Channel High Speed Counters

Incorporates a 30kHz, 2 phase, 24-bit counter and eliminates the need for an additional high-speed counter.

The Visual KV base unit incorporates 2-channel, 2 phase high-speed counters and high-speed counter comparators. This allows direct connection with a rotary encoder and counting input from the encoder. The Visual KV can be used for various applications, such as speed measurement and high speed interval counting; by utilizing the input capture functions, that automatically saves input values to the 4 interrupt inputs during high-speed counting.

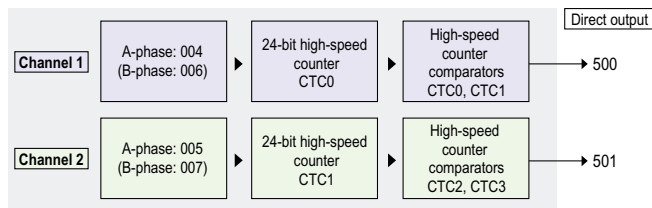

4 High Speed Interrupt Inputs

Incorporates 4 high-speed interrupt inputs with a maximum speed of 10 s.

When an interrupt input occurs, the routine scanning is suspended and the interrupt inputs are immediately processed with a response time of only 10 s. The Visual KV is optimal for fast sensor input on high-speed lines.

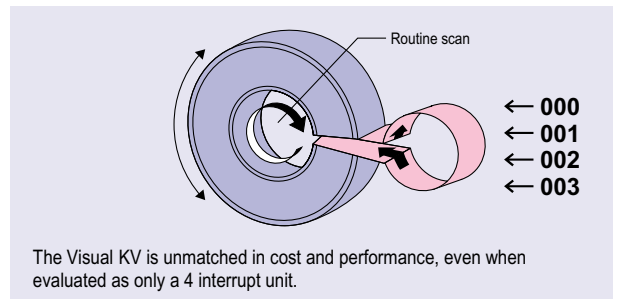

Simple Ramping Control Function

Incorporates a single-axis stepper motor control independent of the high-speed counter function that allows a motor up to 50kHz to be controlled.

The Visual KV incorporates a positioning control function similar to expensive units for application practicality and cost reduction.

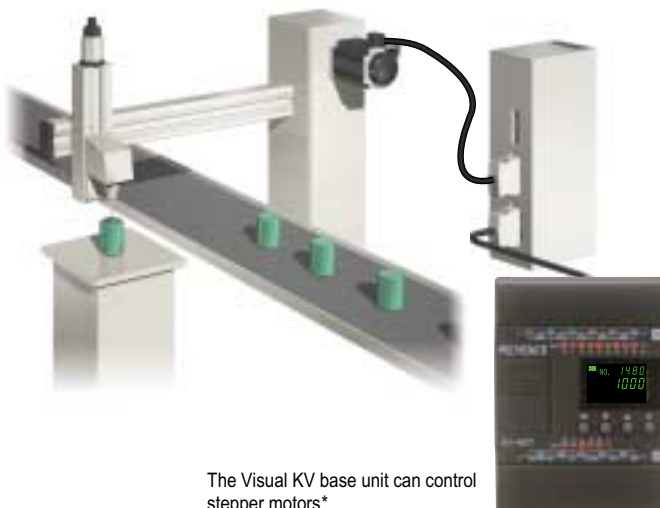

The Visual KV base unit can control stepper motors.*

The simple positioning control stepper function can be activated by just inputting the setting values into the specific data memories.

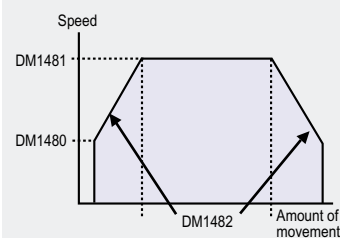

Setting items for the positioning control function (x-axis)

- Start-up frequency (Hz) : DM1480
- Run frequency (Hz) : DM1481
- Acceleration/deceleration period (ms) : DM1482
- Number of output pulses (high order): DM1485 (low order): DM1484
- Operation start relay : 2310
- Forced slowdown stop relay : 2308
- Emergency stop relay : 2309

Only 1-line of ladder logic is needed to create the positioning control function.

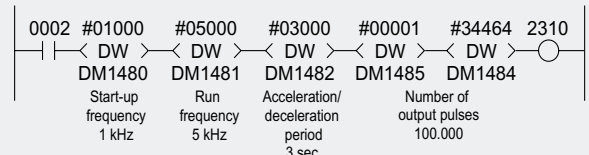

Frequency Counter Function

Measures the rotational frequency of a gear or rotary encoder without complicated programming.

To achieve this measurement, simply input the frequency counting period into the specified data memory using a real number in "ms". The measured result is automatically input into the specified data memory. The measured result can be displayed on the Access Window.

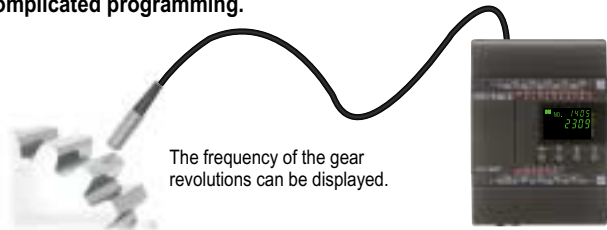

Specified Frequency Pulse Output Function

Easily controls motor speed.

Without complicated programming, pulses with a specified frequency (16 to 50000Hz) can be output. Just input the frequency (Hz) into the specified data memory using a real number. The pulses with the specified frequency are then output from the output (501). The function allows multi-step speed control, as shown to the right.

The preset speed of a motor can be manually changed by simply using the Access Window. This feature is ideal for systems that require frequent setting changes or fine adjustments.

Complicated multi-step ramp up-and-down control is possible.

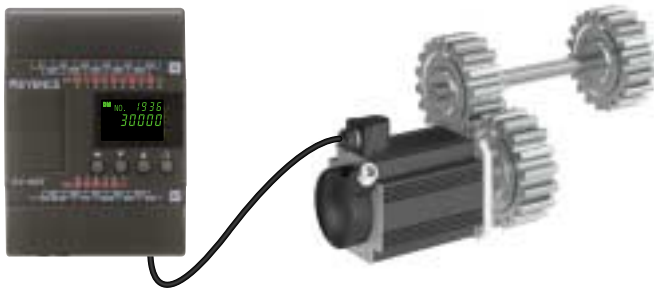
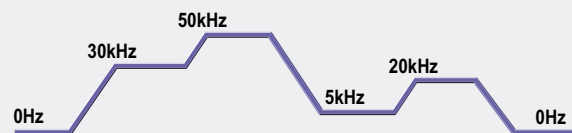

The Visual KV can be used as a simple stepper motor controller by setting the output frequency on the Access Window.*

Applications

Tension adjustment of hoop material



Time adjustment of sheet immersion in a treatment bath



Synchronization Control Function

A single Visual KV unit enables synchronization control.

Pulses with a measured frequency can be output* by combining the frequency counter function with the specified-frequency pulse output.

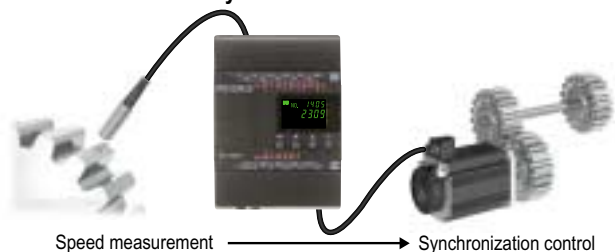

Cam Switch Function

Serves as a simple cam switch.

An operation similar to that of a Cam can be achieved by combining an inexpensive rotary encoder with the Visual KV. Connect the rotary encoder to the Visual KV and input the desired angles into the specified data memories. The relays can then be turned on or off at the specified angles (up to 32 points, in increments of 1 degree.) This Function of the Visual KV can be utilized as an alternative to an expensive Cam switch in order to reduce overall costs.

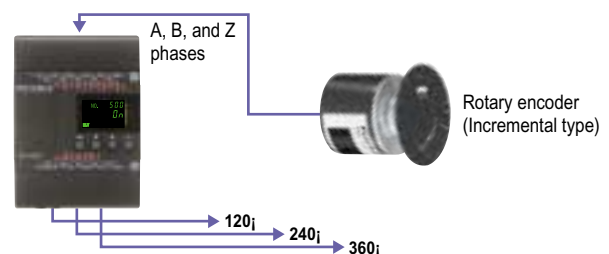

*: A motor driver is required separately.

Software

"Ladder Builder for KV" ensures fast, easy programming and efficient desktop debugging.

Simulator Quick debugging without a PLC

The KV Ladder Builder can simulate program execution even without a PLC connected. Providing a single step execution (forward and reverse) in addition to a regular scan execution function increases debugging efficiency.

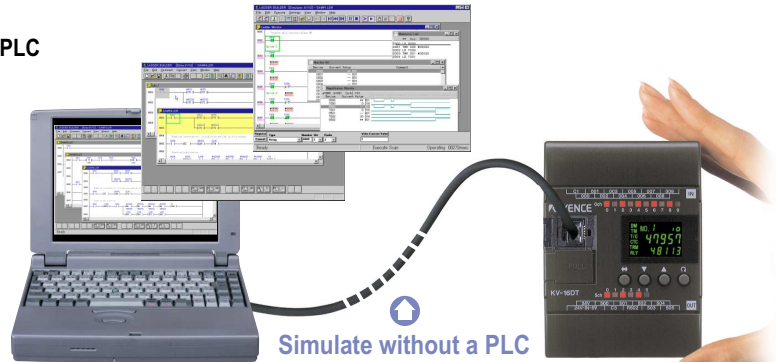

Simulate without a PLC

Our new Desktop simulator, simulates a program in operation before you connect your PLC

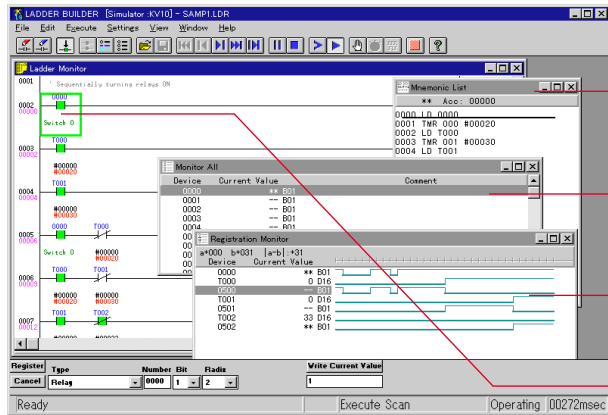

Forward / Reverse Single Step Execution

Checking the operation process one step at a time can easily identify complex operation problems.

Monitor All Function

Timers, counters and data memories can be checked simultaneously in multiple windows. For effective debugging, you can check all devices at once, even those that do not appear in the ladder diagram.

Registration Monitor

The Ladder Builder simultaneously displays multiple timing charts of any devices, conveniently allowing all on/off timing elements to be checked.

Ladder Simulator Allows Verification of Diagram Execution

By clicking an element in the ladder diagram, the simulator quick screen appears allowing the elements to set or reset.

Editor Easy Editing Using Windows[®] Functions

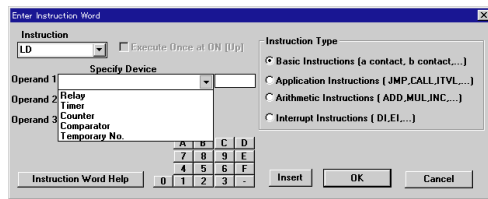

Instruction Selection Window

The user-friendly design allows data to be entered from a keyboard or mouse. You can specify a device or command from a drop down menu, eliminating errors. For programming purposes you can also enter the symbol directly by typing the command.

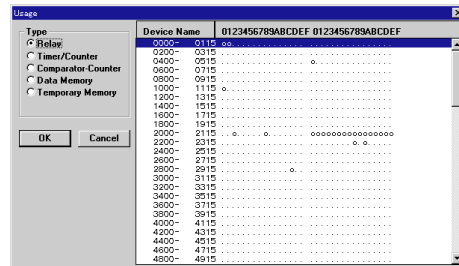

Usage List

When creating Ladder diagrams the usage list automatically tracks and displays addresses that have been used.

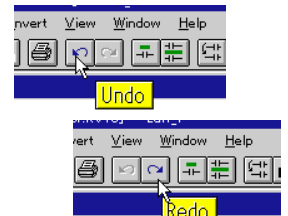

UNDO Function

The Ladder Builder for KV enables efficient editing. If you accidentally delete an instruction, you can undo the action simply by clicking the undo button.

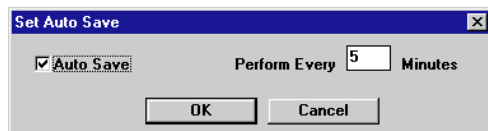

Auto-Save Function

The Ladder Builder automatically backs-up the program at pre-determined intervals. This protects the data from being lost due to a power loss or system crash.

Monitor Real time monitoring without machine stoppage

Ladder diagram and element on/off status can be monitored in real time. In addition, timing charts can also be monitored simultaneously.

* MS-windows and Windows are registered trademarks of Microsoft. Any other company name is registered trademark of that company.

System Variations

Base Units

Fully equipped with Access Windows, 16 types of base unit with various special functions, such as positioning control and high-speed counters, are available.

The "Special Mini Display" provides basic display functions at a low cost.

KV-D20 Operator Panel

4 function switches and 4 indicators can be customized and preset as desired. Comments on the ladder diagram can be displayed. The KV-D20, with practical functions, is a cost saving system component.



Ladder Builder Software KV-H6WU2 (Windows)

Ladder programming created for the conventional KV Series can be utilized with the Visual KV.

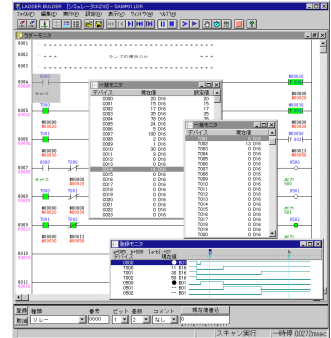

Handheld programmer with a memory card slot KV-P3E-01

The handheld programmer can be used to easily transfer and save ladder diagrams. (The M-2 and M-3 memory cards are available separately.)



I/O 10
6 inputs / 4 outputs

I/O 16
10 inputs / 6 outputs

I/O 24
16 inputs / 8 outputs

I/O 40
24 inputs / 16 outputs

AC Relay



KV-10AR



KV-16AR



KV-24AR



KV-40AR

AC Transistor



KV-10AT (P)



KV-16AT (P)



KV-24AT (P)



KV-40AT (P)

DC Relay



KV-10DR



KV-16DR



KV-24DR



KV-40DR

DC Transistor



KV-10DT (P)



KV-16DT (P)



KV-24DT (P)



KV-40DT (P)

Expansion Units

An expansion unit can be mounted up to 300mm away from an adjacent unit. 8 types of I/O expansion unit permit a flexible layout.

8

16

4+4

Input

8 Inputs
KV-E8X



16 Inputs
KV-E16X



8 transistor outputs
KV-E8T (P)



16 transistor outputs
KV-E16T (P)



Output

8 relay outputs
KV-E8R



16 relay outputs
KV-E16R



4 inputs/
4 outputs
(Relay)
KV-E4XR



4 inputs/
4 outputs
(Transistor)
KV-E4XT (P)



Specifications

General specifications

Model	AC type KV-10AT(P)/AR KV-16AT(P)/AR KV-24AT(P)/AR KV-40AT(P)/AR	DC type KV-10DT(P)/DR KV-16DT(P)/DR KV-24DT(P)/DR KV-40DT(P)/DR
Power supply	100 to 240 VAC (−10%)	24 VDC (−10%)
AC power current consumption	KV-10AT(P)/AR: 0.4 A KV-16AT(P)/AR: 0.5 A KV-24AT(P)/AR: 0.6 A KV-40AT(P)/AR: 0.7 A	—
AC power factor	60%	—
Output voltage	24 VDC (−10%)	—
Output capacity (Including the internal current consumption and current consumption of expansion units.)	KV-10AT(P)/AR: 0.4 A KV-16AT(P)/AR: 0.6 A KV-24AT(P)/AR: 0.6 A KV-40AT(P)/AR: 0.7 A	—
Allowable instantaneous interruption time	40 ms max.	2 ms max.
Internal current consumption (converted into 24 VDC value)	KV-10AR/DR: 100 mA max. KV-10AT(P)/DT(P): 80(85) mA max. KV-16AR/DR: 120 mA max. KV-16AT(P)/DT(P): 90(100) mA max. KV-24AR/DR: 140 mA max. KV-24AT(P)/DT(P): 100(105) mA max. KV-40AR/DR: 180 mA max. KV-40AT(P)/DT(P): 120(130) mA max.	
	KV-E8X: 25 mA max. KV-E16X: 35 mA max. KV-E8T(P): 40 mA max. KV-E16T(P): 60(70) mA max. KV-E8R: 70 mA max. KV-E16R: 110 mA max. KV-E4XR: 45 mA max. KV-E4XT(P): 30 mA max.	
	KV-D20 Operator panel: 60 mA max. KV-P3E Handheld programmer: 65 mA max.	
Ambient temperature	0 to +50°C, 0 to +45°C (KV-P3E-01)	
Relative humidity	35 to 85%	
Ambient storage temperature	−20 to +70°C	
Withstand voltage	1,500 VAC for 1 minute (Between power terminal and I/O terminals, and between external terminals and housing)	
Noise immunity	1,500 Vp-p min., pulse width: 1 s, 50 ns (by noise simulator) Conforming to EN standard (EN55011-2/-3/-4/-6)	
Shock	150 m/s ² (15 G), working time: 11 ms, in X, Y and Z directions, 2 times respectively	
Vibration	10 to 55 Hz, 1.5 mm max. double amplitude in X, Y and Z directions, 2 hours respectively (1 G max. when attached to DIN rail)	
Insulation resistance	50 M Ω min. (Between power terminal and I/O terminals, and between external terminals and housing, measured with 500 VDC megohmmeter)	
Environmental restrictions	No excessive dust or corrosive gases	
Weight	KV-10AR: Approx. 250 g, KV-10AT(P): Approx. 240 g, KV-16AR: Approx. 300 g, KV-16AT(P): Approx. 290 g, KV-24AR: Approx. 350 g, KV-24AT(P): Approx. 330 g, KV-40AR: Approx. 450 g, KV-40AT(P): Approx. 420 g, KV-10DR: Approx. 150 g, KV-10DT(P): Approx. 150 g, KV-16DR: Approx. 190 g, KV-16DT(P): Approx. 180 g, KV-24DR: Approx. 240 g, KV-24DT(P): Approx. 220 g, KV-40DR: Approx. 330 g, KV-40DT(P): Approx. 290 g	

Performance specifications

Arithmetic operation control method	Stored program method
I/O control method	Refresh method
Programming language	Ladder diagram and expanded ladder diagram
Instruction types	Basic instruction: 28, Application instruction: 22, Arithmetic instruction: 26, Interrupt instruction: 4
Minimum scan time	140 s min.
Instruction processing time	Basic instruction: 0.7 s min., Application instruction: 6.4 s min.
Program capacity	2,000 steps (KV-10□□, KV-16□□) 4,000 steps (KV-24□□, KV-40□□)
Maximum number of expansion units	8 (7 for KV-40□□)
Number of I/O points (including 16 to 40 I/O points of basic unit)	16 to 152 points (when expansion units are connected)
Internal utility relay	2,560 points: 1000 to 1915 and 3000 to 17915
Special utility relay	160 points: 2000 to 2915
Data memory (16 bits)	2,000 words: DM 0000 to DM1999
Temporary data memory (16 bits)	32 words: TM00 to TM31
Timer/counter	0.1-s timer: TMR (0 to 6553.5 s), 0.01-s timer: TMH (0 to 655.35 s), 0.001-s timer: TMS (0 to 65.535 s), UP counter: C, Up/down counter: UDC
Digital trimmer	2 trimmers (set in access window)
High-speed counter	2 counters of 30 kHz, 2-phase high-speed counter (0 to 65535 count) *1
High-speed counter comparator	4 comparators (2 for each high-speed counter) Direct output allowed
Positioning control function	Independent 1 axis, 50 kHz max.
Memory switch	16
Memory backup	Program memory: Flash ROM, rewritable 100,000 times or more Data memory, counter, internal utility relay: Data retained for 2 months min. with electrical double-layer capacitor (at 25°C). Data can be backed up with EEP ROM in all models. <small>(Retention devices are set by MEMSW instruction.)</small>
Self-diagnosis	CPU and RAM errors
Number of contact comments	1,000 max. contact comments can be saved.

*1. 24-bit setting is available.

Input/output circuit of base unit

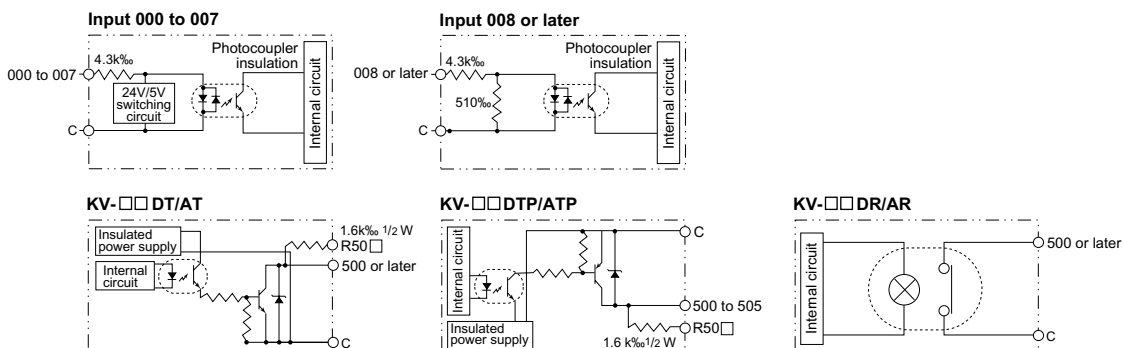

Input specifications of base unit

Model	KV-10□□	KV-16□□	KV-24□□	KV-40□□
No. of inputs	6	10	16	24
Input common	COM is connected internally.			
Maximum input rating	26.4 VDC			
Input voltage *1	24 VDC, 5.3 mA/5 VDC, 1.0 mA			
Input time constant	10 ms (Typical) 10 s when HSP instruction is used Variable in 7 steps from 10 s to 10 ms while special utility relay 2813 is ON (Set by DM1940)			
Interrupt input response	10 s (Typical)			
High-speed counter input response	30 kHz (24V-10%)			

*1. Inputs 000 to 007 can be changed to 5 V input.

Output specifications of basic unit

Model	KV-10□T	KV-16□T	KV-24□T	KV-40□T	KV-10□R	KV-16□R	KV-24□R	KV-40□R
No. of outputs	4	6	8	16	4	6	8	16
Output common	1 common				Each common terminal is independent.			
Output type	Transistor output (NPN or PNP)				Relay output			
Rated load	30 VDC 0.3 A (503 and other) 0.1 A (500 to 502)				250 VAC/30 VDC 2 A (Inductive load) 4 A (Resistive load)			
Peak load current	0.2 A (500 to 502) 1 A (Other)				5 A			
Relay service life	—				Electrical service life: 100,000 times or more (20 times/min) Mechanical service life: 20-million times or more			
Relay replacement	—				Not allowed			
Output frequency	50 kHz (500 to 502)				—			
Built-in serial resistance	1.6 k Ω 1/2W (R500 to R502)				—			

Input/output specifications of expansion unit

Input/output	Input		Output				Input/output
External connection method	Terminal block						
Model	KV-E8X	KV-E16X	KV-E8T(P)	KV-E16T(P)	KV-E8R	KV-E16R	KV-E4XT(P)/R
Number of inputs	8	16	—		—		4
Input common	4 points/common		—		—		4 points/common
Maximum input rating	26.4 VDC		—		—		26.4 VDC
Input voltage	24 VDC, 5.3 mA		—		—		24 VDC, 5.3 mA
Minimum ON voltage	19 V		—		—		19 V
Maximum OFF current	2 mA		—		—		2 mA
Input impedance	4.3 k Ω		—		—		4.3 k Ω
Input time constant (Changed in two steps by special utility relays 2609 to 2612)	For both rising (OFF \rightarrow ON) and falling (ON \rightarrow OFF) operations, 10 ms: 10 ms-20%, 10 s: 10 s-20%		—		—		For both rising (OFF \rightarrow ON) and falling (ON \rightarrow OFF) operations, 10 ms: 10 ms-20%, 10 s: 10 s-20%
Number of outputs	—		8	16	8	16	4
Output type	—		NPN (PNP) Transistor		Relay		NPN (PNP) Transistor/Relay
Output common	—		COM is connected internally.		4 points/common		4 points/common
Rated load voltage	—		30 VDC		250 VAC/30 VDC, 2 A (Inductive load), 4 A (Resistive load)		30 VDC, 250 VAC/30 VDC, 2 A (Inductive load), 4 A (Resistive load)
Rated output current	—		0.5 (0.3) A/point		2 A/point (Inductive load), 4 A/point (Resistive load), 4 A/common		0.5 (0.3) A/point, 2 A/point (Inductive load), 4 A (Resistive load), 4 A/common
ON resistance	—		—		50 m Ω or less		— / 50 m Ω or less
Leakage current at OFF	—		100 A max.		—		100 A max./ —
Residual voltage at ON	—		0.8 V max.		—		0.8 V max./ —
Rising operation time (OFF \rightarrow ON)	—		50 s max.		10 ms max.		50 s max./10 ms max.
Falling operation time (ON \rightarrow OFF)	—		250 s max.		10 ms max.		250 s max./10 ms max.
Relay service life	—		—		Electrical: 100,000 times or more (20 times/min), Mechanical: 20-million times or more		Electrical: 100,000 times or more (20 times/min), Mechanical: 20-million times or more
Relay replacement	—		—		Not allowed		— /Not allowed
Weight	Approx. 100 g	Approx. 140 g	Approx. 100 g	Approx. 140 g	Approx. 130 g	Approx. 190 g	Approx. 100 g/Approx. 120 g

Input/output circuit of expansion unit

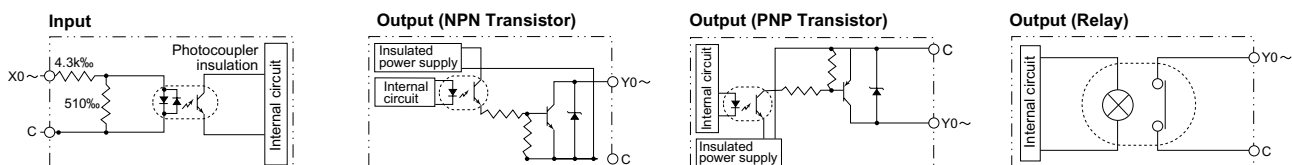

Dimensions

Base Units

KV-10DT(P)/DR/AT(P)/AR

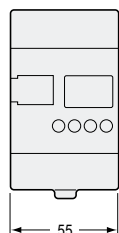

KV-10DT(P)/DR

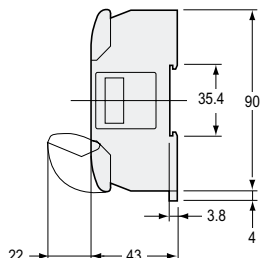

KV-10AT(P)/AR

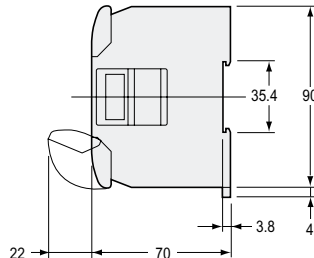

Mounting bracket OP-35345

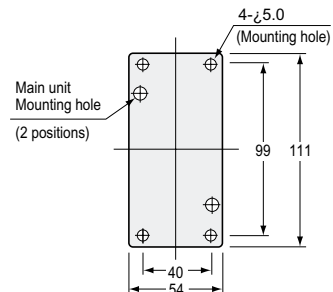

KV-16DT(P)/DR/AT(P)/AR

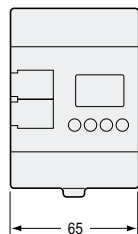

KV-16DT(P)/DR

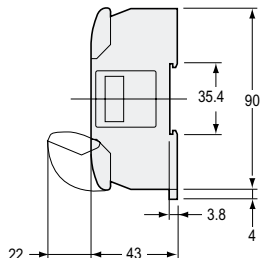

KV-16AT(P)/AR

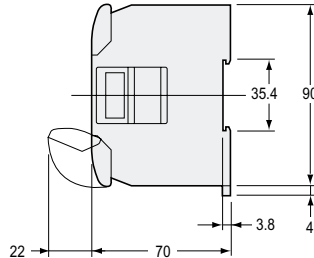

Mounting bracket OP-35346

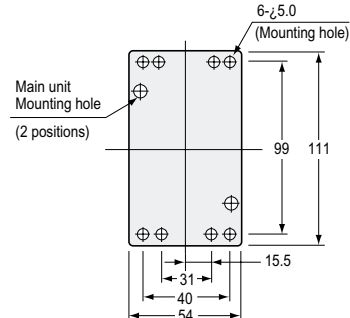

KV-24DT(P)/DR/AT(P)/AR

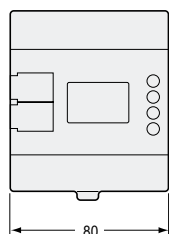

KV-24DT(P)/DR

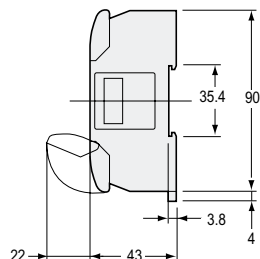

KV-24AT(P)/AR

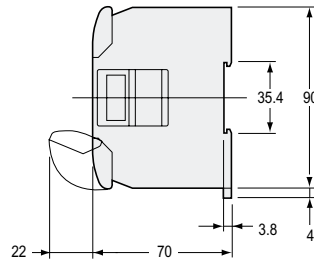

Mounting bracket OP-35347

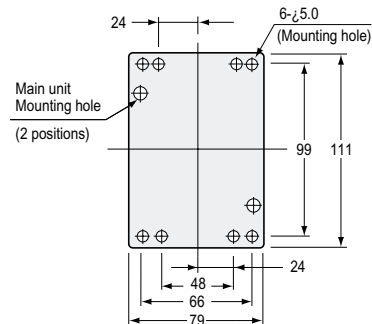

KV-40DT(P)/DR/AT(P)/AR

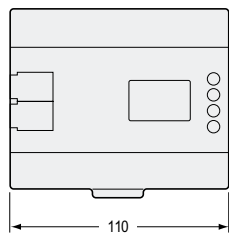

KV-40DT(P)/DR

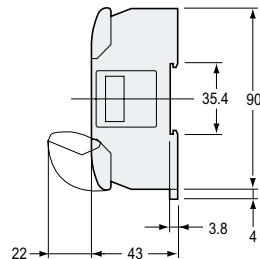

KV-40AT(P)/AR

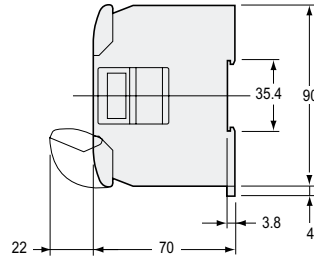

Mounting bracket OP-35348

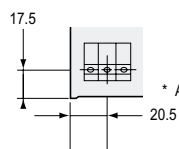
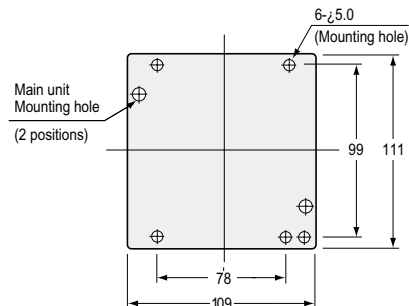

* AC power terminal part detail. Common to all AC types.

Expansion Units

KV-E8X/8T(P)/8R/4XT(P)/4XR **KV-E16X/16T(P)/16R**

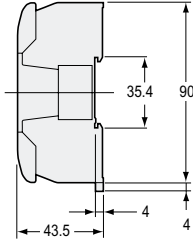
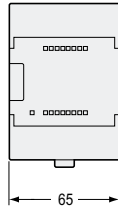
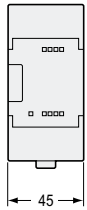

Mounting bracket OP-35349

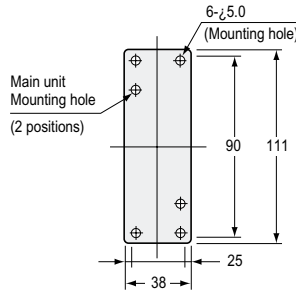

Expansion Units Spacer Patent pending

OP-35343 KV-E8X/T(P)/R, KV-E4XT(P)/R **OP-35344** KV-E16X/T(P)/R

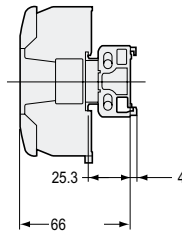
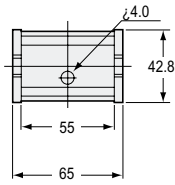
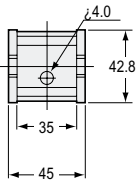

Operator Panel

KV-D20

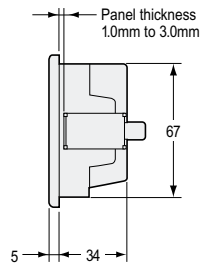
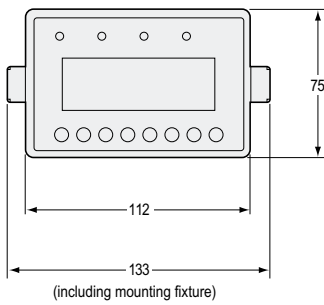

Panel Cutout

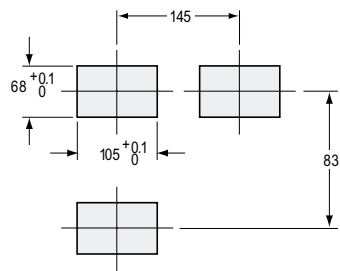

New KV Series Model List

Category	Name	Model	Description
Basic unit	10-point AC type	KV-10AT(P)	6-point input/4-point NPN (PNP) transistor output
		KV-10AR	6-point input/4-point relay output
	10-point DC type	KV-10DT(P)	6-point input/4-point NPN (PNP) transistor output
		KV-10DR	6-point input/4-point relay output
	16-point AC type	KV-16AT(P)	10-point input/6-point NPN (PNP) transistor output
		KV-16AR	10-point input/6-point relay output
	16-point DC type	KV-16DT(P)	10-point input/6-point NPN (PNP) transistor output
		KV-16DR	10-point input/6-point relay output
	24-point AC type	KV-24AT(P)	16-point input/8-point NPN (PNP) transistor output
		KV-24AR	16-point input/8-point relay output
	24-point DC type	KV-24DT(P)	16-point input/8-point NPN (PNP) transistor output
		KV-24DR	16-point input/8-point relay output
	40-point AC type	KV-40AT(P)	24-point input/16-point NPN (PNP) transistor output
		KV-40AR	24-point input/16-point relay output
	40-point DC type	KV-40DT(P)	24-point input/16-point NPN (PNP) transistor output
		KV-40DR	24-point input/16-point relay output
Expansion unit	8-point type	KV-E8X	8-point input
		KV-E8T(P)	8-point NPN (PNP) transistor output
		KV-E8R	8-point relay output
		KV-E4XT(P)	4-point input/4-point NPN (PNP) transistor output
		KV-E4XR	4-point input/4-point relay input
	16-point type	KV-E16X	16-point input
		KV-E16T(P)	16-point NPN (PNP) transistor output
		KV-E16R	16-point relay output
Easy-to-set display	Operator panel	KV-D20	20 digits x 4 lines with customized switches/lamps (cable included)
Extension cable for expansion unit	For all expansion units and adapters	OP-35361	For 300-mm extension
Expansion unit spacer	Spacer for 8-point expansion unit	OP-35343	Used to make an expansion unit flush with an AC power type basic unit.
	Spacer for 16-point expansion unit	OP-35344	
Metal fixture for screw tightening	For 10-point basic unit	OP-35346	Used to directly mount the KV series with screws instead of a DIN rail.
	For 16-point basic unit	OP-35346	
	For 24-point basic unit	OP-35347	
	For 40-point basic unit	OP-35348	
	For 8- to 16-point expansion unit	OP-35349	
Programming	Handheld programmer	KV-P3E-01	Memory card slot, cable (OP-26487) included
	Programming support software	KV-H6WU2	Windows version With simulator function, delivered in two 3.5-inch floppy disks (cable included)
	Cable/connector for PC/AT or compatibles	OP-26487	For D-sub 9-pin, Basic unit-to-PC with programming support software
		OP-26486	
	Memory card	M-2	Saves/reads ladder programs via KV-P3E(01) s slot or Z-1 card reader/writer. M-2: 24 programs max., M-3: 48 programs max.
M-3			

Visit our website for other Keyence products at <http://www.keyence.co.uk>

Specifications are subject to change without notice.



European Headquarters
KEYENCE (UK) LIMITED
 504-510 Elder House, Station Square,
 Elder Gate, Milton Keynes MK9 1LR, U.K.
 PHONE: 01908-696900 FAX: 01908-696777

Worldwide Headquarters
KEYENCE CORPORATION
 1-3-14, Higashi-Nakajima, Higashi-Yodogawa-ku,
 Osaka, 533-8555, Japan
 PHONE: 81-6-6379-2211 FAX: 81-6-6379-2131

KEYENCE CORPORATION OF AMERICA
 PHONE: 201-930-0100 FAX: 201-930-0099

KEYENCE DEUTSCHLAND GmbH
 PHONE: 0711-7973710 FAX: 0711-7977799

KEYENCE FRANCE S.A.
 PHONE: 01 47 92 76 76 FAX: 01 47 92 76 77

KEYENCE SINGAPORE PTE LTD
 PHONE: 392-1011 FAX: 392-5055

KEYENCE (MALAYSIA) SDN BHD
 PHONE: 03-252-2211 FAX: 03-252-2131

KEYENCE (THAILAND) CO., LTD
 PHONE: 02-934-6777 FAX: 02-934-6775

KEYENCE KOREA CORPORATION
 PHONE: 02-563-1270 FAX: 02-563-1271

KEYENCE CORPORATION, 1999
 NKV-EU-C-2-1199 Printed in Japan