

DC Input Modules

D2-08ND3 DC Input <--->	
Inputs per Module	8 (sink/source)
Commons per Module	1 (2 I/O terminal points)
Input Voltage Range	10.2-26.4 VDC
Peak Voltage	26.4 VDC
ON Voltage Level	9.5 VDC minimum
OFF Voltage Level	3.5 VDC maximum
AC Frequency	N/A
Input Impedance	2.7 kΩ
Input Current	4.0 mA @ 12 VDC 8.5 mA @ 24 VDC
Minimum ON Current	3.5 mA
Maximum OFF Current	1.5 mA
Base Power Required 5VDC	50 mA
OFF to ON Response	1 to 8 ms
ON to OFF Response	1 to 8 ms
Terminal Type (included)	Removable, D2-810CON
Status Indicator	Logic side
Weight	2.3 oz. (65 g)

See page 4-78 for part numbers of **ZIPLink** cables and connection modules compatible with this I/O module.

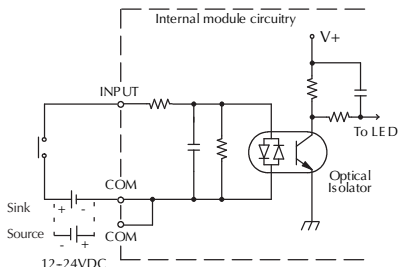
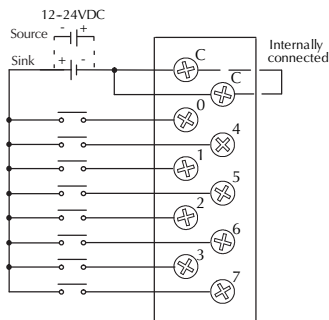
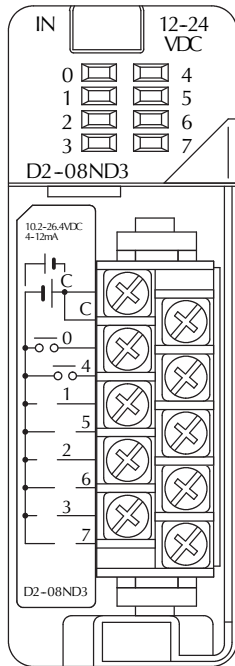
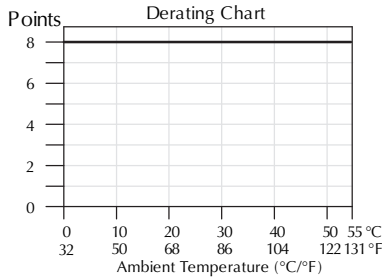

For "Sinking and Sourcing Concepts", see the Appendix section.

D2-16ND3-2 DC Input <--->	
Inputs per Module	16 (sink/source)
Commons per Module	2 isolated (8 I/O terminal points / com)
Input Voltage Range	20-28 VDC
Peak Voltage	30 VDC (10 mA)
ON Voltage Level	19 VDC minimum
OFF Voltage Level	7VDC maximum
AC Frequency	N/A
Input Impedance	3.9 kΩ
Input Current	6 mA @ 24 VDC
Minimum ON Current	3.5 mA
Maximum OFF Current	1.5 mA
Base Power Required 5VDC	100 mA
OFF to ON Response	3 to 9 ms
ON to OFF Response	3 to 9 ms
Terminal Type (included)	Removable, D2-1610CON
Status Indicator	Logic side
Weight	2.3 oz. (65 g)

See page 4-78 for part numbers of **ZIPLink** cables and connection modules compatible with this I/O module.

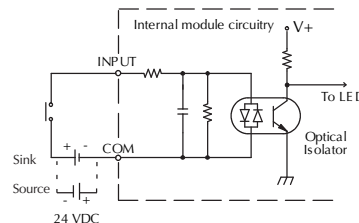
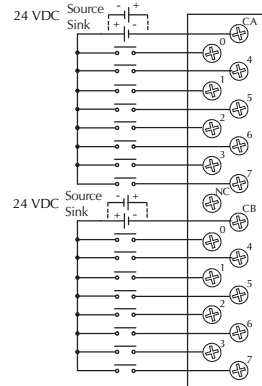
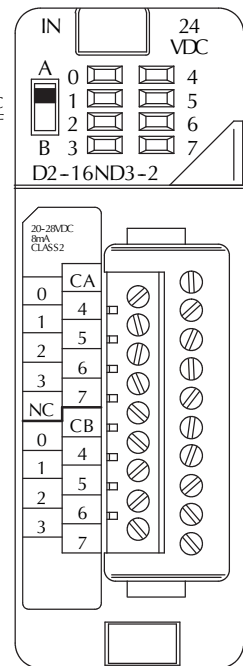
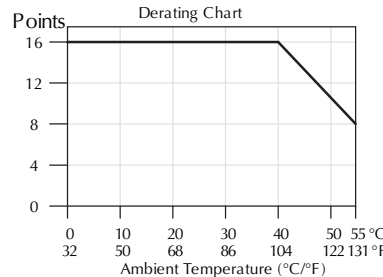

For "Sinking and Sourcing Concepts" see the Appendix section.

Wiring Solutions using the ZIPLink Wiring System

ZIPLinks eliminate the normally tedious process of wiring between devices by utilizing prewired cables and DIN rail mount connector modules. It's as simple as plugging in a cable connector at either end or terminating wires at only one end. Prewired cables keep installation clean and efficient, using half the space at a fraction of the cost of standard terminal blocks. There are several wiring solutions available when using the ZIPLink System ranging from PLC I/O-to-ZIPLink Connector Modules that are ready for field termination, options for connecting to third party devices, GS, DuraPulse and SureServo Drives, and specialty relay, transorb and communications modules. Pre-printed I/O-specific adhesive label strips for quick marking of ZIPLink modules are provided with ZIPLink cables. See the following solutions to help determine the best ZIPLink system for your application.

Solution 1: DirectLOGIC, CLICK and Productivity3000 I/O Modules to ZIPLink Connector Modules

When looking for quick and easy I/O-to-field termination, a ZIPLink connector module used in conjunction with a prewired ZIPLink cable, consisting of an I/O terminal block at one end and a multi-pin connector at the other end, is the best solution.

Using the PLC I/O Modules to ZIPLink Connector Modules selector tables located in this section,

1. Locate your I/O module/PLC.
2. Select a ZIPLink Module.
3. Select a corresponding ZIPLink Cable.



Solution 2: DirectLOGIC, CLICK and Productivity3000 I/O Modules to 3rd Party Devices

When wanting to connect I/O to another device within close proximity of the I/O modules, no extra terminal blocks are necessary when using the ZIPLink Pigtail Cables. ZIPLink Pigtail Cables are prewired to an I/O terminal block with color-coded pigtail with soldered-tip wires on the other end.

Using the I/O Modules to 3rd Party Devices selector tables located in this section,

1. Locate your PLC I/O module.
2. Select a ZIPLink Pigtail Cable that is compatible with your 3rd party device.



Solution 3: GS Series and DuraPulse Drives Communication Cables

Need to communicate via Modbus RTU to a drive or a network of drives?

ZIPLink cables are available in a wide range of configurations for connecting to PLCs and SureServo, SureStep, Stellar Soft Starter and AC drives. Add a ZIPLink communications module to quickly and easily set up a multi-device network.

Using the Drives Communication selector tables located in this section,

1. Locate your Drive and type of communications.
2. Select a ZIPLink cable and other associated hardware.



Solution 4: Serial Communications Cables

ZIPLink offers communications cables for use with *Direct*LOGIC, CLICK, and Productivity3000 CPUs, that can also be used with other communications devices. Connections include a 6-pin RJ12 or 9-pin, 15-pin and 25-pin D-sub connectors which can be used in conjunction with the RJ12 or D-Sub Feedthrough modules.

Using the **Serial Communications Cables** selector table located in this section,

1. Locate your connector type
2. Select a cable.



Solution 5: Specialty ZIPLink Modules

For additional application solutions, ZIPLink modules are available in a variety of configurations including stand-alone relays, 24VDC and 120VAC transorb modules, D-sub and RJ12 feedthrough modules, communication port adapter and distribution modules, and *SureServo* 50-pin I/O interface connection.

Using the **ZIPLink Specialty Modules** selector table located in this section,

1. Locate the type of application.
2. Select a ZIPLink module.

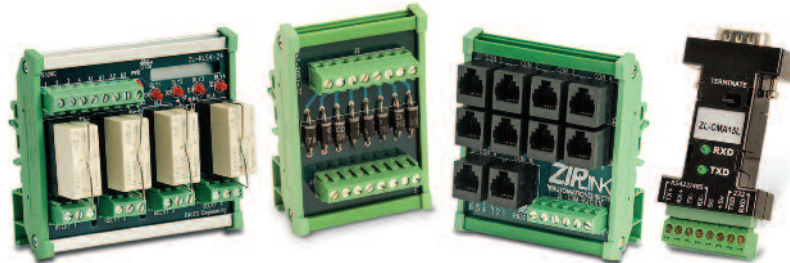

Solution 6: ZIPLink Connector Modules to 3rd Party Devices

If you need a way to connect your device to terminal blocks without all that wiring time, then our pigtail cables with color-coded soldered-tip wires are a good solution. Used in conjunction with any compatible ZIPLink Connector Modules, a pigtail cable keeps wiring clean and easy and reduces troubleshooting time.

Using the **Universal Connector Modules and Pigtail Cables** table located in this section,

1. Select module type.
2. Select the number of pins.
3. Select cable.



PLC I/O Modules to ZIPLink Connector Modules - DL205

DL205 PLC Input Module ZIPLink Selector				
PLC		ZIPLink		
Input Module	# of Terms	Component	Module Part No.	Cable Part No. †
D2-08ND3	10	Feedthrough	ZL-RTB20	ZL-D2-CBL10*
D2-16ND3-2	19	Feedthrough	ZL-RTB20	ZL-D2-CBL19*
		Sensor	ZL-LTB16-24	ZL-D2-CBL19*
D2-32ND3 ¹	40	Feedthrough	ZL-RTB40	ZL-D24-CBL40*
				ZL-D24-CBL40*X
		Sensor	ZL-LTB32-24	ZL-D24-CBL40*
				ZL-D24-CBL40*X
D2-32ND3-2 ¹	40	Feedthrough	ZL-RTB40	ZL-D24-CBL40*
				ZL-D24-CBL40*X
		Sensor	ZL-LTB32-24	ZL-D24-CBL40*
				ZL-D24-CBL40*X
D2-08NA-1	10	Feedthrough	ZL-RTB20	ZL-D2-CBL10*
D2-08NA-2	10	Feedthrough	ZL-RTB20	ZL-D2-CBL10*
D2-12NA	19	Feedthrough	ZL-RTB20	ZL-D2-CBL19*

† X in the part number represents a 45° angle.

DL205 PLC Combo In/Out Module ZIPLink Selector				
PLC		ZIPLink		
Combo Module	# of Terms	Component	Module Part No.	Cable Part No.
D2-08CDR	10	Feedthrough	ZL-RTB20	ZL-D2-CBL10*

DL205 PLC Analog Module ZIPLink Selector				
PLC		ZIPLink		
Analog Module	# of Terms	Component	Module	Cable
F2-04AD-1	10	Feedthrough	ZL-RTB20	ZL-D2-CBL10*
F2-04AD-1L	10	Feedthrough	ZL-RTB20	ZL-D2-CBL10*
F2-08AD-1	10	Feedthrough	ZL-RTB20	ZL-D2-CBL10*
F2-04AD-2	10	Feedthrough	ZL-RTB20	ZL-D2-CBL10*
F2-04AD-2L	10	Feedthrough	ZL-RTB20	ZL-D2-CBL10*
F2-08AD-2	10	Feedthrough	ZL-RTB20	ZL-D2-CBL10*
F2-02DA-1	10	Feedthrough	ZL-RTB20	ZL-D2-CBL10*
F2-02DA-1L	10	Feedthrough	ZL-RTB20	ZL-D2-CBL10*
F2-02DAS-1	10	Feedthrough	ZL-RTB20	ZL-D2-CBL10*
F2-08DA-1	19	Feedthrough	ZL-RTB20	ZL-D2-CBL19*
F2-02DA-2	10	Feedthrough	ZL-RTB20	ZL-D2-CBL10*
F2-02DA-2L	10	Feedthrough	ZL-RTB20	ZL-D2-CBL10*
F2-02DAS-2	10	Feedthrough	ZL-RTB20	ZL-D2-CBL10*
F2-08DA-2	10	Feedthrough	ZL-RTB20	ZL-D2-CBL10*
F2-4AD2DA	10	Feedthrough	ZL-RTB20	ZL-D2-CBL10*
F2-8AD4DA-1	19	Feedthrough	ZL-RTB20	ZL-D2-CBL19*
F2-8AD4DA-2	19	Feedthrough	ZL-RTB20	ZL-D2-CBL19*
F2-04RTD ⁴	Matched Only		See Note 4	
F2-04THM ⁴	Matched Only		See Note 4	



DL205 PLC Output Module ZIPLink Selector				
PLC		ZIPLink		
Output Module	# of Terms	Component	Module Part No.	Cable Part No. †
D2-04TD1 ²	10	Feedthrough	ZL-RTB20	ZL-D2-CBL10*
D2-08TD1	10	Feedthrough	ZL-RTB20	ZL-D2-CBL10*
D2-08TD2	10	Feedthrough	ZL-RTB20	ZL-D2-CBL10*
D2-16TD1-2	19	Feedthrough	ZL-RTB20	ZL-D2-CBL19*
		Fuse	ZL-RFU20 ⁵	ZL-D2-CBL19*
		Relay	ZL-RRL16-24-1	ZL-D2-CBL19*
D2-16TD2-2	19	Feedthrough	ZL-RTB20	ZL-D2-CBL19*
		Fuse	ZL-RFU20	ZL-D2-CBL19*
		Relay	ZL-RRL16-24-2	ZL-D2-CBL19*
F2-16TD1P	19	Feedthrough	ZL-RTB20	ZL-D2-CBL19*
		Relay	ZL-RRL16-24-1	ZL-D2-CBL19*
F2-16TD2P	19	Feedthrough	ZL-RTB20	ZL-D2-CBL19*
		Relay	ZL-RRL16-24-2	ZL-D2-CBL19*
D2-32TD1 ¹	40	Feedthrough	ZL-RTB40	ZL-D24-CBL40*
				ZL-D24-CBL40*X
		Fuse	ZL-RFU40 ⁵	ZL-D24-CBL40*
D2-32TD2 ¹	40	Feedthrough	ZL-RTB40	ZL-D24-CBL40*
				ZL-D24-CBL40*X
		Fuse	ZL-RFU40 ⁵	ZL-D24-CBL40*
				ZL-D24-CBL40*X
D2-08TA	10	Feedthrough	ZL-RTB20	ZL-D2-CBL10*
F2-08TA	10	Feedthrough	ZL-RTB20	ZL-D2-CBL10*
D2-12TA	19	Feedthrough	ZL-RTB20	ZL-D2-CBL19*
		Fuse	ZL-RFU20 ⁵	ZL-D2-CBL19*
D2-04TRS ³	10	Feedthrough	ZL-RTB20	ZL-D2-CBL10*
D2-08TR	10	Feedthrough	ZL-RTB20	ZL-D2-CBL10*
F2-08TRS ³	19	Feedthrough	ZL-RTB20	ZL-D2-CBL19*
F2-08TR ⁴	10	Feedthrough	ZL-RTB20	ZL-D2-CBL10*
D2-12TR	19	Feedthrough	ZL-RTB20	ZL-D2-CBL19*
		Fuse	ZL-RFU20 ⁵	ZL-D2-CBL19*

† X in the part number represents a 45° angle plug

* Select the cable length by replacing the * with: Blank = 0.5m, -1 = 1.0m, or -2 = 2.0m.

¹ To make a custom cable for the 32-point modules, use: Ribbon-style Connector ZL-D24-CON-R, Solder-style 180° connector ZL-D24-CON or Solder-style 45° connector ZL-D24-CON-X

² Caution: The D2-04TD1, D2-04TRS, and F2-08TRS outputs are derated not to exceed module specs 2A per point and 2A per common when used with the ZIPLink wiring system.

³ The F2-08TR outputs are derated not to exceed 2A per point and 4A per common when used with the ZIPLink wiring system.

⁴ The F2-04RTD and F2-04THM modules are not supported by the ZIPLink wiring system.

⁵ Note: Fuses (5 x 20 mm) are not included. See Edison Electronic Fuse section for (5 x 20 mm) fuse. S500 and GMA electronic circuit protection for fast-acting maximum protection. S506 and GMC electronic circuit protection for time-delay performance. Ideal for inductive circuits.

To ensure proper operation, do not exceed the voltage and current rating of ZIPLink module. ZL-RFU20 = 2A per circuit; ZL-RFU40 = 400 mA per circuit.



NOTE: ZIPLINK CONNECTOR MODULES SPECIFICATIONS FOLLOW THE COMPATIBILITY MATRIX TABLES. ZIPLINK CABLES SPECIFICATIONS ARE AT THE END OF THIS ZIPLINK SECTION.

Power Requirements

These charts help determine your power requirements

This section shows the amount of power supplied by each of the base power supplies and the amount of power consumed by each DL205 device. The Power Consumed charts list how much INTERNAL power from each power source is required for the DL205 devices. Use this information when calculating the power budget for your system.

In addition to the internal power sources, the DL205 bases offer a 24 VDC auxiliary power supply with external power connections. This auxiliary power supply can power external devices.

Use ZIPLinks to reduce power requirements

If your application requires a lot of relay outputs, consider using the ZIPLink AC or DC relay output modules. These modules can switch high current (10A) loads without putting a load on your base power budget. Refer to the Terminal Blocks and Wiring Solutions section in this catalog for more information.

This logo is placed next to the I/O modules that are supported by the ZIPLink connection systems. See the I/O module specifications at the end of this section.



Power Consumed		
Device	5V(mA)	24V Auxiliary
Operator Interface		
DV-1000	150	0
C-more Micro-Graphic	210	0

Power Supplied							
Device	Price	5V(mA)	24V Auxiliary	Device	Price	5V(mA)	24V Auxiliary
Bases				Bases			
D2-03B-1	<--->	2600	300	D2-06BDC1-1	<--->	2600	None
D2-03BDC1-1	<--->	2600	None	D2-06BDC2-1	<--->	2600	300
D2-04B-1	<--->	2600	300	D2-09B-1	<--->	2600	300
D2-04BDC1-1	<--->	2600	None	D2-09BDC1-1	<--->	2600	None
D2-06B-1	<--->	2600	300	D2-09BDC2-1	<--->	2600	300

Power Consumed		
Device	5V(mA)	24V Auxiliary
CPUs		
D2-230	120	0
D2-240	120	0
D2-250-1	330	0
D2-260	330	0
H2-WPLC**	680	0
DC Input Modules		
D2-08ND3	50	0
D2-16ND3-2	100	0
D2-32ND3	25	0
D2-32ND3-2	25	0
AC Input Modules		
D2-08NA-1	50	0
D2-08NA-2	100	0
D2-16NA	100	0
Input Simulator Module		
F2-08SIM	50	0
DC Output Modules		
D2-04TD1	60	20
D2-08TD1	100	0
D2-08TD2	100	0
D2-16TD1-2	200	80
D2-16TD2-2	200	0
F2-16TD1P	70	50
F2-16TD2P	70	50
D2-32TD1	350	0
D2-32TD2	350	0
AC Output Modules		
D2-08TA	250	0
F2-08TA	250	0
D2-12TA	350	0
Relay Output Modules		
D2-04TRS	250	0
D2-08TR	250	0
F2-08TR(S)	670	0
D2-12TR	450	0
Combination In/Out Module		
D2-08CDR	200	0

Power Consumed		
Device	5V(mA)	24V Auxiliary
Analog Modules		
F2-04AD-1	100	5
F2-04AD-2	110	5
F2-08AD-1	100	5
F2-08AD-2	100	5
F2-02DA-1	40	60 (note 1)
F2-02DA-1L	40	70 @ 12V (note 1)
F2-02DA-2	40	60
F2-02DA-2L	40	70 @ 12V
F2-02DAS-1	100	50 / channel
F2-02DAS-2	100	60 / channel
F2-08DA-1	30	50 (note 1)
F2-08DA-2	60	140
F2-4AD2DA	60	80 (note 1)
F2-8AD4DA-1	35	100 (note 1)
F2-8AD4DA-2	35	80 (note 1)
F2-04RTD	90	0
F2-04THM	110	60
Specialty Modules		
D2-CTRINT	50*	0
D2-CM / D2-EM	100/130	0
H2-CTRIO	400	0
D2-DCM	300	0
F2-DEVNETS	160	0
F2-SDS-1	160	0
H2-PBC	530	0
H2-EBC(-F)	450, (640)	0
H2-ECOM(-F)	450, (640)	0
H2-ECOM100	300	0
F2-CP128	235	0
Remote I/O		
H2-ERM(-F)	320, (450)	0
D2-RMSM	200	0
D2-RSSS	150	0
Programming Devices		
D2-HPP	200	0

*requires external 5VDC for outputs
Note 1: Add an additional 20 mA per output loop.