

contact load (K) (current through enabling paths) and switching cycle number (n-op/y).

In case of 365 operating days per year and a 24-hour operation, this results in the specified switching cycle times (t-cycle) for the relay contacts.

Diverging applications on request.

K	n-op/y	t-cycle
20 %	525.600	1,0 min
40 %	210.240	2,5 min
60 %	75.067	7,0 min
80 %	30.918	17,0 min
100 %	12.223	43,0 min

Global Properties

Permanent light	SRB 301LC/B
Standards	IEC/EN 60204-1, EN 60947-5-1, EN ISO 13849-1, IEC 61508
Compliance with the Directives (Y/N) 	Yes
Climatic stress	EN 60068-2-78
Mounting	snaps onto standard DIN rail to EN 60715
Terminal designations	IEC/EN 60947-1
Materials	
- Material of the housings	Plastic, glass-fibre reinforced thermoplastic, ventilated
- Material of the contacts	AgSnO, self-cleaning, positive action
Weight	230
Start conditions	Automatic or Start button
Start input (Y/N)	Yes
Feedback circuit (Y/N)	Yes
Start-up test (Y/N)	No
Automatic reset function (Y/N)	Yes
Reset with edge detection (Y/N)	No
Pull-in delay	
- ON delay with automatic start	≤ 300 ms
- ON delay with reset button	≤ 20 ms
Drop-out delay	
- Drop-out delay in case of emergency stop	≤ 25 ms

Mechanical data

Connection type	Screw connection
Cable section	
- Min. Cable section	0,25
- Max. Cable section	2.5
Pre-wired cable	rigid or flexible
Tightening torque for the terminals	0,6
Detachable terminals (Y/N)	No
Mechanical life	10.000.000 operations
Electrical lifetime	Derating curve available on request
resistance to shock	30 g / 11 ms
Resistance to vibration To EN 60068-2-6	10...55 HZ, Amplitude 0,35 mm, ± 15 %

Ambient conditions

Ambient temperature	
- Min. environmental temperature	-25 °C
- Max. environmental temperature	+45 °C
Storage and transport temperature	
- Min. Storage and transport temperature	-40 °C

- Max. Storage and transport temperature	+85 °C
Protection class	
- Protection class-Enclosure	IP40
- Protection class-Terminals	IP20
- Protection class-Clearance	IP54
Air clearances and creepage distances To IEC/EN 60664-1	
- Rated impulse withstand voltage U_{imp}	4 kV
- Overvoltage category	II To VDE 0110
- Degree of pollution	2 To VDE 0110

Electromagnetic compatibility (EMC)

EMC rating	conforming to EMC Directive
------------	-----------------------------

Electrical data

Rated DC voltage for controls	
- Max. rated DC voltage for controls	20.4
- Max. rated DC voltage for controls	28.8
Rated AC voltage for controls, 50 Hz	
- Min. rated AC voltage for controls, 50 Hz	20.4
- Max. rated AC voltage for controls, 50 Hz	26.4
Rated AC voltage for controls, 60 Hz	
- Min. rated AC voltage for controls, 60 Hz	20.4
- Max. rated AC voltage for controls, 60 Hz	26.4
Contact resistance	max. 100 mΩ
Power consumption	max. 1.7 W; 1.9 VA
Type of actuation	AC/DC
Switch frequency	max. 5 HZ
Rated operating voltage U_e	24 VDC -15% / +20%, residual ripple max. 10% 24 VAC -15% / +10%
Operating current I_e	0,08 A
Frequency range	50 / 60 HZ
Electronic protection (Y/N)	No
Fuse rating for the operating voltage	0,5 A gG D-fuse

Inputs

Monitored inputs	
- Short-circuit recognition (Y/N)	No
- Wire breakage detection (Y/N)	Yes
- Earth connection detection (Y/N)	Yes
Number of shutters	0 piece
Number of openers	2 piece
Cable length	1500 m with 1.5 mm ² ; 2500 m with 2.5 mm ²
Conduction resistance	max. 40 Ω

Outputs





Stop category	0
Number of safety contacts	3 piece
Number of auxiliary contacts	1 piece
Number of signalling outputs	0 piece

Switching capacity	
- Switching capacity of the safety contacts	max. 250 VAC, 6 A ohmic (inductive in case of appropriate protective wiring) min. 10 V, 10 mA
- Switching capacity of the auxiliary contacts	24 VDC, 2 A
Fuse rating	
- Protection of the safety contacts	6 A slow blow
- Fuse rating for the auxiliary contacts	2 A slow blow
Utilisation category To EN 60947-5-1	AC-15: 230 V / 6 A DC-13: 24 V / 6 A
Number of undelayed semi-conductor outputs with signaling function	0 piece
Number of undelayed outputs with signaling function (with contact)	1 piece
Number of delayed semi-conductor outputs with signaling function.	0 piece
Number of delayed outputs with signalling function (with contact).	0 piece
Number of secure undelayed semi-conductor outputs with signaling function	0 piece
Number of secure, undelayed outputs with signaling function, with contact.	3 piece
Number of secure, delayed semi-conductor outputs with signaling function	0 piece
Number of secure, delayed outputs with signaling function (with contact).	0 piece

LED switching conditions display

LED switching conditions display (Y/N)	Yes
Number of LED's	4
LED switching conditions display	
- The integrated LEDs indicate the following operating states.	
- Position relay K1	
- Position relay K2	
- Supply voltage	
- Internal operating voltage Ui	

Miscellaneous data

Applications	 Emergency-Stop button  Guard system  Pull-wire emergency stop switches  Safety light curtain  Safety sensor
--------------	---

Dimensions

Dimensions	
- Width	22.5 mm
- Height	100 mm
- Depth	121 mm

notice

Inductive loads (e.g. contactors, relays, etc.) are to be suppressed by means of a suitable circuit.

notice - Wiring example

Input level: The example shows a 2-channel control of a guard door monitoring with two position switches, whereof one with positive break, external reset button (R); cross-wire monitoring and feedback circuit (H2)

The control system recognises wire-breakage and earth faults in the monitoring circuit.

Relay outputs: Suitable for 2 channel control, for increase in capacity or number of contacts by means of contactors or relays with positive-guided contacts.

For 1-channel control, connect NC contact to S11/S12 and bridge S12/S22

Connect potential p-type outputs of safety light grids/curtains to S12/S22. The devices must have the same reference potential.

Automatic start: The automatic start is programmed by connecting the feedback circuit to the terminals X1/X2. If the feedback circuit is not required, establish a bridge

The wiring diagram is shown with guard doors closed and in de-energised condition.

Documents

Operating instructions and Declaration of conformity (es) 292 kB, 06.06.2018

Code: mrl_srb_301lc_b_es

Operating instructions and Declaration of conformity (nl) 291 kB, 13.07.2018

Code: mrl_srb_301lc_b_nl

Operating instructions and Declaration of conformity (pt) 298 kB, 17.08.2018

Code: mrl_srb_301lc_b_pt

Operating instructions and Declaration of conformity (fr) 345 kB, 29.06.2018

Code: mrl_srb_301lc_b_fr

Operating instructions and Declaration of conformity (de) 272 kB, 18.05.2018

Code: mrl_srb_301lc_b_de

Operating instructions and Declaration of conformity (da) 319 kB, 29.08.2013

Code: mrl_srb_301lc_b_da

Operating instructions and Declaration of conformity (pl) 301 kB, 06.09.2018

Code: mrl_srb_301lc_b_pl

Operating instructions and Declaration of conformity (it) 295 kB, 22.01.2018

Code: mrl_srb_301lc_b_it

Operating instructions and Declaration of conformity (en) 293 kB, 18.05.2018

Code: mrl_srb_301lc_b_en

Operating instructions and Declaration of conformity (jp) 337 kB, 03.01.2014

Code: mrl_srb_301lc_b_jp

Wiring example (99) 15 kB, 06.08.2009

Code: ksr3123

Wiring example (99) 20 kB, 22.08.2008

Code: ksr3111

CCC certification (cn) 296 kB, 16.01.2017

Code: q_srbp02

CCC certification (en) 314 kB, 16.01.2017

Code: q_srbp01

Images

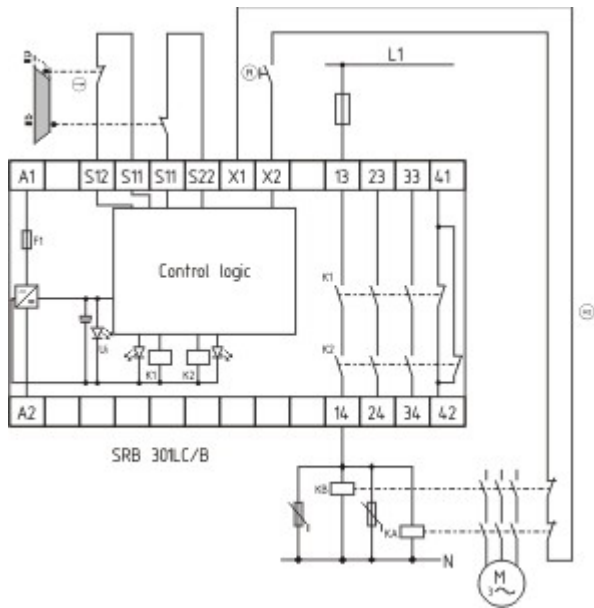

Wiring example

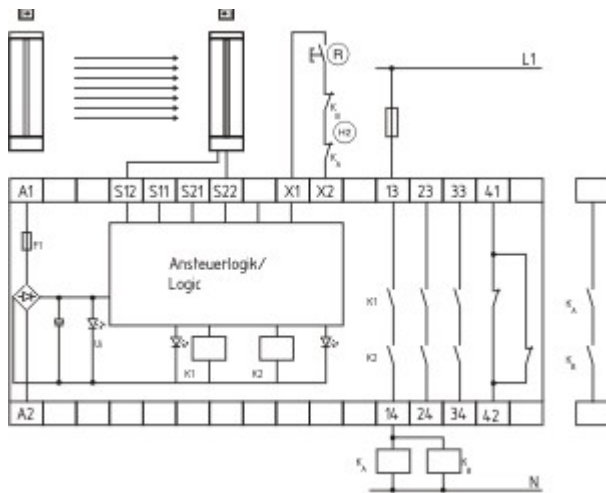

Wiring example

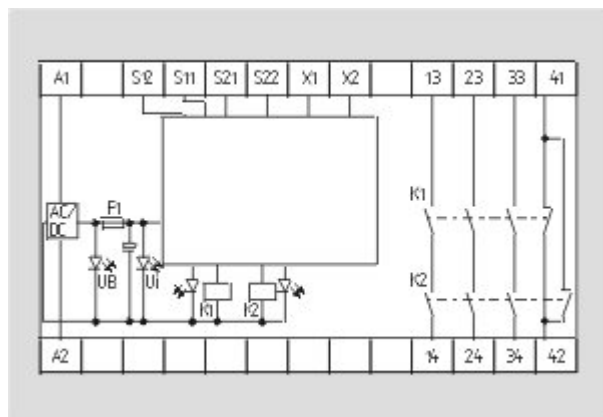

Internal wiring diagram

The data and values have been checked thoroughly. Technical modifications and errors excepted.

Generiert am 03.10.2018 - 18:21:13h Kasbase 3.3.0.F.64I